

1 Output

3-Screen Display High-Precision Digital Pressure Switch

25A-ZSE20(F)/ISE20 Series



RoHS

IP40



How to Order

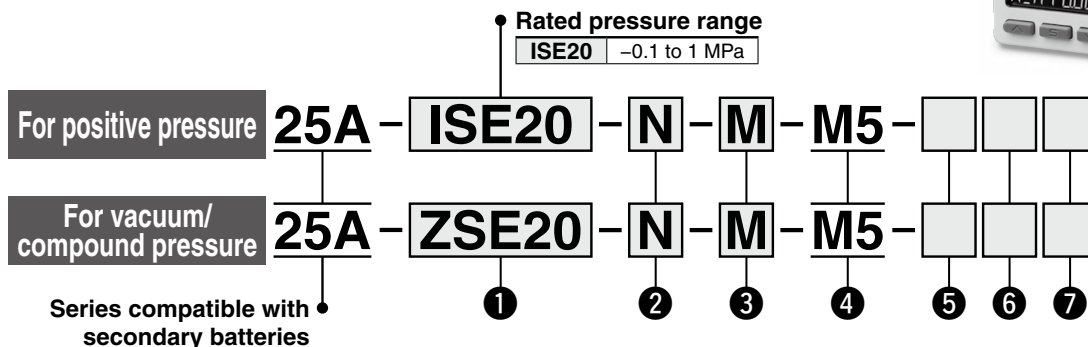

① Rated pressure range

ZSE20	0 to -101 kPa
ZSE20F	-100 to 100 kPa

② Output specification

Symbol	Description
N	NPN open collector 1 output
P	PNP open collector 1 output

④ Piping specification

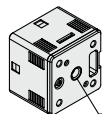
Symbol	Description
M5	M5 female thread 

③ Unit specification

Symbol	Description
Nil	Units selection function*1
M	SI unit only*2
P	Units selection function (Initial value psi)*1

*1 Under the New Measurement Act, switches with the units selection function are not permitted for use in Japan.

*2 Fixed unit: kPa, MPa

⑤ Option 1

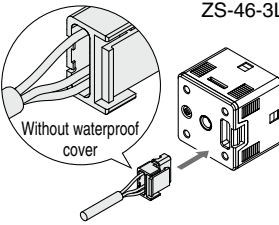
Symbol	Description
Nil	Without lead wire
L	Lead wire with connector (3-core, 2 m lead wire) 

⑥ Option 2

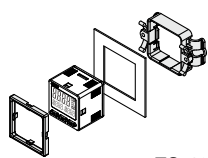
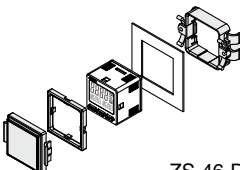
Symbol	Description
Nil	None
B	Panel mount adapter 
D	Panel mount adapter + Front protection cover 

⑦ Option 3

Symbol	Operation manual*1	Calibration certificate*1
Nil	○	—
Y	—	—
K	○	○
T	—	○

*1 All texts are in both English and Japanese.

Options/Part Nos.

When only optional parts are required, order with the part numbers listed below.

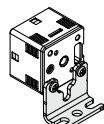
Description	Part no.	Note
Panel mount adapter	ZS-46-B	—
Panel mount adapter + Front protection cover	ZS-46-D	—
Lead wire with connector	ZS-46-3L	3-core, 2 m, Non-waterproof (Without waterproof cover)
Lead wire with M12 connector	25A-ZS-46-5FM12	 * Individual part
Front protection cover	ZS-27-01	—
Bracket A	25A-ZS-46-A1	 * Individual part

* The 25A-series specifications and dimensions are the same as those of the standard model.

For details, refer to the [Web Catalog](#).

2 Outputs + Analog Output (Voltage/Current)



3-Screen Display High-Precision Digital Pressure Switch

RoHS

IP40

25A-ZSE20A(F)/ISE20A Series



How to Order

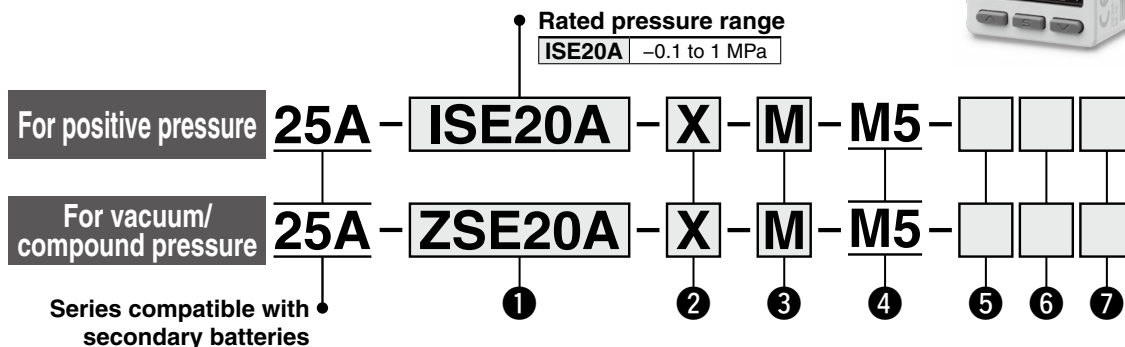

① Rated pressure range

ZSE20A	0 to -101 kPa
ZSE20AF	-100 to 100 kPa

③ Unit specification

Symbol	Description
Nil	Units selection function*1
M	SI unit only*2
P	Units selection function (Initial value psi)*1

*1 Under the New Measurement Act, switches with the units selection function are not permitted for use in Japan.

*2 Fixed unit: kPa, MPa

④ Piping specification

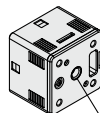
Symbol	Description
M5	M5 female thread 

② Output specification

Symbol	Description
R	NPN open collector 2 outputs + Analog voltage output*1
S	NPN open collector 2 outputs + Analog current output*1
T	PNP open collector 2 outputs + Analog voltage output*1
V	PNP open collector 2 outputs + Analog current output*1
X	NPN open collector 2 outputs + Copy function
Y	PNP open collector 2 outputs + Copy function

*1 Can be switched to auto-shift or copy function

⑤ Option 1

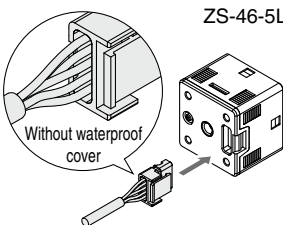
Symbol	Description
Nil	Without lead wire
J	Lead wire with connector (5-core, 2 m lead wire) 

⑥ Option 2

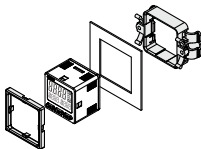
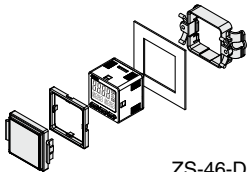
Symbol	Description
Nil	None
B	Panel mount adapter 
D	Panel mount adapter + Front protection cover 

⑦ Option 3

Symbol	Operation manual*1	Calibration certificate*1
Nil	○	—
Y	—	—
K	○	○
T	—	○

*1 All texts are in both English and Japanese.

Options/Part Nos.

When only optional parts are required, order with the part numbers listed below.

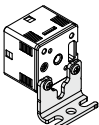
Description	Part no.	Note
Panel mount adapter	ZS-46-B	—
Panel mount adapter + Front protection cover	ZS-46-D	—
Lead wire with connector	ZS-46-5L	5-core, 2 m, Non-waterproof (Without waterproof cover)
Lead wire with M12 connector	25A-ZS-46-5FM12	 * Individual part
Front protection cover	ZS-27-01	—
Bracket A	25A-ZS-46-A1	 * Individual part

* The 25A-series specifications and dimensions are the same as those of the standard model.

For details, refer to the [Web Catalog](#).

2 Outputs + Analog Output (Voltage/Current)



3-Screen Display High-Precision Digital Pressure Switch

RoHS

IP65

25A-ZSE20B(F)/ISE20B Series



How to Order

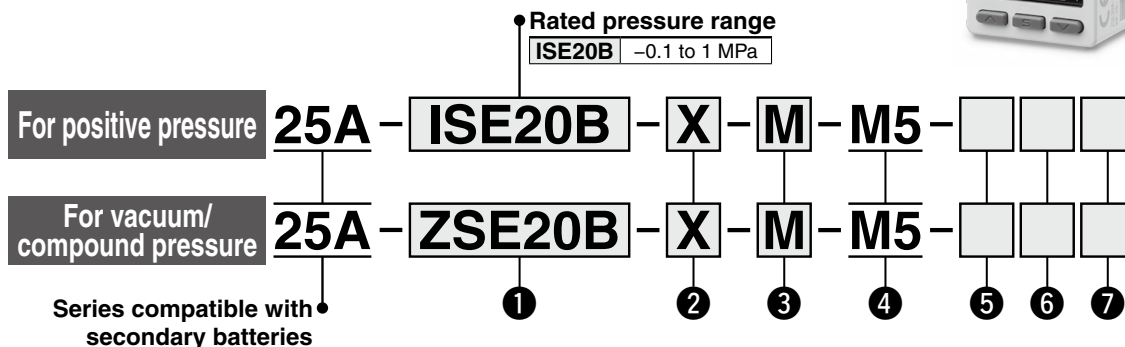

① Rated pressure range

ZSE20B	0 to -101 kPa
ZSE20BF	-100 to 100 kPa

② Output specification

Symbol	Description
R	NPN open collector 2 outputs + Analog voltage output *1
S	NPN open collector 2 outputs + Analog current output *1
T	PNP open collector 2 outputs + Analog voltage output *1
V	PNP open collector 2 outputs + Analog current output *1
X	NPN open collector 2 outputs + Copy function
Y	PNP open collector 2 outputs + Copy function

*1 Can be switched to auto-shift or copy function

③ Unit specification

Symbol	Description
Nil	Units selection function*1
M	SI unit only*2
P	Units selection function (Initial value psi)*1

*1 Under the New Measurement Act, switches with the units selection function are not permitted for use in Japan.

*2 Fixed unit: kPa, MPa

④ Piping specification

Symbol	Description
M5	M5 female thread

⑤ Option 1

Symbol	Description
Nil	Without lead wire
W	Lead wire with connector (5-core, 2 m lead wire, With waterproof cover)

⑦ Option 3

Symbol	Operation manual*1	Calibration certificate*1
Nil	○	—
Y	—	—
K	○	○
T	—	○

*1 All texts are in both English and Japanese.

⑥ Option 2

Symbol	Description
Nil	None
B	Panel mount adapter
D	Panel mount adapter + Front protection cover

Options/Part Nos.

When only optional parts are required, order with the part numbers listed below.

Description	Part no.	Note
Panel mount adapter	ZS-46-B	—
Panel mount adapter + Front protection cover	ZS-46-D	—
Lead wire with connector	ZS-46-5F	5-core, 2 m, Waterproof (With waterproof cover)
Lead wire with M12 connector	25A-ZS-46-5FM12	* Individual part
Front protection cover	ZS-27-01	—
Bracket A	25A-ZS-46-A1	* Individual part

* The 25A-series specifications and dimensions are the same as those of the standard model.

For details, refer to the [Web Catalog](#).

IO-Link Compatible (1 Output)



RoHS

IP65

3-Screen Display High-Precision Digital Pressure Switch

25A-ZSE20B(F)-L/ISE20B-L Series



How to Order

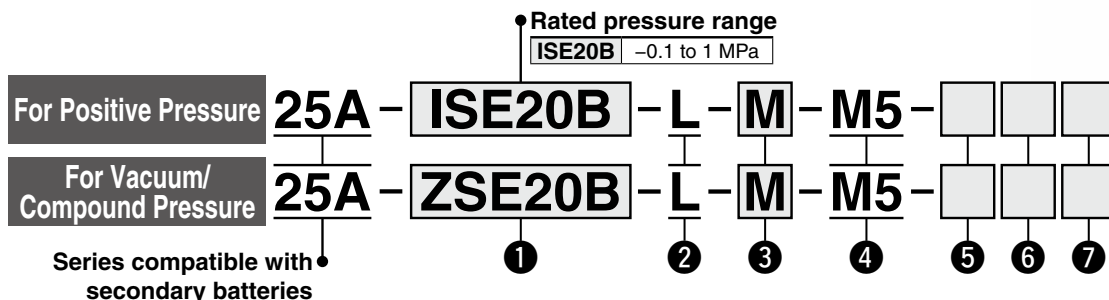

1 Rated pressure range

ZSE20B	0 to -101 kPa
ZSE20BF	-100 to 100 kPa

2 Output specification

Symbol	Description
L	IO-Link/Switch: 1 output ⇐ (PNP or NPN switching type for switch output)

3 Unit specification

Symbol	Description
Nil	Units selection function*1
M	SI units only*2
P	Units selection function (Initial value psi)*1

*1 Under the New Measurement Act, switches with the units selection function are no longer allowed for use in Japan.

*2 Fixed units: kPa, MPa

4 Piping specification

Symbol	Description
M5	M5 female thread

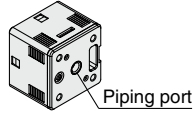

5 Option 1

Symbol	Description
Nil	Without lead wire
W	Lead wire with connector (5-core, 2 m lead wire, With waterproof cover)

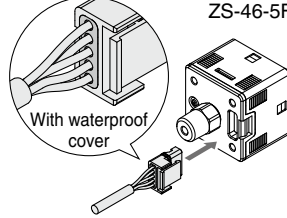

7 Option 3

Symbol	Operation manual*1	Calibration certificate*1
Nil	○	—
Y	—	—
K	○	○
T	—	○

*1 All texts are in both English and Japanese.

6 Option 2

Symbol	Description
Nil	None
B	Panel mount adapter
D	Panel mount adapter + Front protection cover

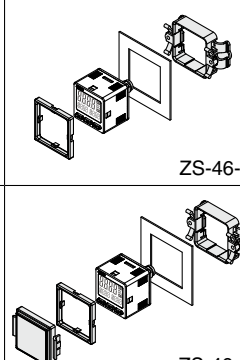

Options/Part Nos.

When only optional parts are required, order with the part numbers listed below.

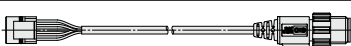
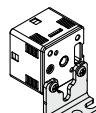
Description	Part no.	Note
Panel mount adapter	ZS-46-B	—
Panel mount adapter + Front protection cover	ZS-46-D	—
Lead wire with connector	ZS-46-5F	5-core, 2 m, Waterproof (With waterproof cover)
Lead wire with M12 connector	25A-ZS-46-5FM12	 * Individual part
Front protection cover	ZS-27-01	—
Bracket A	25A-ZS-46-A1	 * Individual part

* The 25A-series specifications and dimensions are the same as those of the standard model.

For details, refer to the [Web Catalog](#).

2 Outputs + Analog Output (Voltage/Current)



3-Screen Display High-Precision Digital Pressure Switch for General Fluids

RoHS
IP65

25A-ZSE20C(F)/ISE20C(H) Series



How to Order

Rated pressure range

ISE20C	-0.1 to 1 MPa
ISE20CH	-0.1 to 2 MPa

For positive pressure

25A - ISE20C - X - M - 02 - - - -

For vacuum/compound pressure

25A - ZSE20C - X - M - 02 - - - -

Series compatible with secondary batteries

① ② ③ ④ ⑤ ⑥ ⑦ ⑧

① Rated pressure range

ZSE20C	0 to -101 kPa
ZSE20CF	-100 to 100 kPa

③ Unit specification

Symbol	Description
Nil	Units selection function*1
M	SI unit only*2
P	Units selection function (Initial value psi)*1

*1 Under the New Measurement Act, switches with the units selection function are not permitted for use in Japan.

*2 Fixed unit: kPa, MPa

④ Piping specification

Symbol	Description
02	R1/4 (M5 female threaded)
F02	G1/4 (M5 female threaded)

⑤ Piping direction

Nil	Rear ported
L	Bottom ported

② Output specification

Symbol	Description
R	NPN open collector 2 outputs + Analog voltage output*1
S	NPN open collector 2 outputs + Analog current output*1
T	PNP open collector 2 outputs + Analog voltage output*1
V	PNP open collector 2 outputs + Analog current output*1
X	NPN open collector 2 outputs + Copy function
Y	PNP open collector 2 outputs + Copy function

*1 Can be switched to auto-shift or copy function

⑥ Option 1

Symbol	Description
Nil	Without lead wire
W	Lead wire with connector, 5-core (2 m lead wire, With waterproof cover)

⑧ Option 3

Symbol	Operation manual*1	Calibration certificate*1
Nil	○	—
Y	—	—
K	○	○
T	—	○

*1 All texts are in both English and Japanese.

⑦ Option 2

* Note that the optional parts that can be used vary depending on the piping direction.

Symbol	Description
Nil	None

Rear ported (⑤ Piping direction: Nil)

Symbol	Description
B	Panel mount adapter
D	Panel mount adapter + Front protection cover

Bottom ported (⑤ Piping direction: L)

Symbol	Description
E	Panel mount adapter
F	Panel mount adapter + Front protection cover

Options/Part Nos.

When only optional parts are required, order with the part numbers listed below.

Description	Part no.	Note
Panel mount adapter	ZS-46-B	Rear ported
Panel mount adapter	ZS-35-B	Bottom ported
Panel mount adapter + Front protection cover	ZS-46-D	Rear ported
Panel mount adapter + Front protection cover	ZS-35-E	Bottom ported
Lead wire with connector	ZS-46-5F	5-core, 2 m, Waterproof (With waterproof cover)
Lead wire with M12 connector	25A-ZS-46-5FM12	 * Individual part
Front protection cover	ZS-27-01	Rear ported
Bracket A	25A-ZS-46-A1	Rear ported * Individual part

* The 25A-series specifications and dimensions are the same as those of the standard model.

For details, refer to the [Web Catalog](#).

IO-Link Compatible (1 Output)



RoHS

IP65

3-Screen Display High-Precision Digital Pressure Switch for General Fluids

25A-ZSE20C(F)-L/ISE20C(H)-L Series



How to Order

Rated pressure range

ISE20C	-0.1 to 1 MPa
ISE20CH	-0.1 to 2 MPa

For Positive Pressure

25A - ISE20C - L - M - 02 - [] - [] - [] - []

For Vacuum/Compound Pressure

25A - ZSE20C - L - M - 02 - [] - [] - [] - []

Series compatible with secondary batteries

① ② ③ ④ ⑤ ⑥ ⑦ ⑧

① Rated pressure range

ZSE20C	0 to -101 kPa
ZSE20CF	-100 to 100 kPa

② Output specification

Symbol	Description
L	IO-Link/Switch: 1 output ← (PNP or NPN switching type for switch output)

③ Unit specification

Symbol	Description
Nil	Units selection function*1
M	SI units only*2
P	Units selection function (Initial value psi)*1

*1 Under the New Measurement Act, switches with the units selection function are no longer allowed for use in Japan.

*2 Fixed units: kPa, MPa

④ Piping specification

Symbol	Description
02	R1/4 (M5 female threaded)
F02	G1/4 (M5 female threaded)

⑦ Option 2

* Note that the optional parts that can be used vary depending on the piping direction.

Symbol	Description
Nil	None

⑤ Piping direction

Nil	Rear ported
L	Bottom ported

⑥ Option 1

Symbol	Description
Nil	Without lead wire
W	Lead wire with connector, 5-core (2 m lead wire, With waterproof cover)

Rear ported (⑤ Piping direction: Nil)

Symbol	Description	
B	Panel mount adapter	ZS-46-B
D	Panel mount adapter + Front protection cover	ZS-46-D

Bottom ported (⑤ Piping direction: L)

Symbol	Description	
E	Panel mount adapter	ZS-35-B
F	Panel mount adapter + Front protection cover	ZS-35-E

Options/Part Nos.

When only optional parts are required, order with the part numbers listed below.

Description	Part no.	Note
Panel mount adapter	ZS-46-B	Rear ported
	ZS-35-B	Bottom ported
Panel mount adapter + Front protection cover	ZS-46-D	Rear ported
	ZS-35-E	Bottom ported
Lead wire with connector	ZS-46-5F	5-core, 2 m, Waterproof (With waterproof cover)
Lead wire with M12 connector	25A-ZS-46-5FM12	* Individual part
Front protection cover	ZS-27-01	Rear ported
	ZS-35-01	Bottom ported
Bracket A	25A-ZS-46-A1	Rear ported * Individual part

⑧ Option 3

Symbol	Operation manual*3	Calibration certificate*3
Nil	○	—
Y	—	—
K	○	○
T	—	○

*3 All texts are in both English and Japanese.

* The 25A-series specifications and dimensions are the same as those of the standard model.

For details, refer to the [Web Catalog](#).

2-Color Display Digital Flow Switch 25A-PF2M7 Series



How to Order

25A - PF2M7 10 [] - C6 - A W - M [] []

Series compatible with secondary batteries

Integrated display

1 2 3 4 5 6 7 8



1 Rated flow range

01	0.01 to 1 L/min	25	0.3 to 25 L/min
02	0.02 to 2 L/min	50	0.5 to 50 L/min
05	0.05 to 5 L/min	11	1 to 100 L/min
10	0.1 to 10 L/min	21	2 to 200 L/min

2 Piping entry direction

Symbol	Piping entry direction	Rated flow range							
		1	2	5	10	25	50	100	200
Nil	Straight	●	●	●	●	●	●	●	●
L	Rear ported	●	●	●	●	●	●	●	●

3 Port size

Symbol	Port size	Rated flow range							
		1	2	5	10	25	50	100	200
01	Rc1/8	●	●	●	●	●	●	—	—
N1	NPT1/8	●	●	●	●	●	●	—	—
F1	G1/8	●	●	●	●	●	●	—	—
02	Rc1/4	—	—	—	—	—	—	●	●
N2	NPT1/4	—	—	—	—	—	—	●	●
F2	G1/4	—	—	—	—	—	—	●	●
C6	ø6	●	●	●	●	●	●	—	—
C8	ø8	—	—	—	—	—	—	●	●

Piping variations

With One-touch fitting	Female thread
C6, C8	01, 02, N1, N2, F1, F2
Straight	Straight
Rear ported	Rear ported

4 Output specification

Symbol	OUT1	OUT2
A	NPN	NPN
B	PNP	PNP
C	NPN	Analog 1 to 5 V ⇔ Analog 0 to 10 V*1
D	NPN	Analog 4 to 20 mA
E	PNP	Analog 1 to 5 V ⇔ Analog 0 to 10 V*1
F	PNP	Analog 4 to 20 mA

*1 1 to 5 V or 0 to 10 V can be selected by pressing the button.
The default setting is 1 to 5 V.

5 Option 1

W

Lead wire with connector (2 m)
+
Connector cover (Silicone rubber)

ZS-33-F

ZS-33-D

* Interchangeable with the existing PFM7 series

6 Unit specification

M	SI unit only*2
Nil	Unit selection function*3

*2 Fixed unit: Instantaneous flow: L/min
Accumulated flow: L

*3 This product is for overseas use only.
(The SI unit type is provided for use in Japan in accordance with the New Measurement Act.)
The unit can be changed.
Instantaneous flow: L/min ⇔ cfm
Accumulated flow: L ⇔ ft³

8 Calibration certificate*4

Nil	None
A	Yes

*4 Made to order
The certificate is in both English and Japanese.

7 Option 2

Nil	R	T
Without bracket	Bracket (For the type without a flow adjustment valve) 25A-ZS-33-M	Panel mount adapter (For the type without a flow adjustment valve) ZS-33-2J
	<p>With 2 tapping screws (3 x 6)</p>	<p>Panel mount adapter Panel mount adapter B Panel Mounting bracket</p>
	* Interchangeable with the existing PFM series	

* Options are shipped together with the product but do not come assembled.

* The 25A-series specifications and dimensions are the same as those of the standard model.

For details, refer to the [Web Catalog](#).

25A-PF2M7-L Series

How to Order

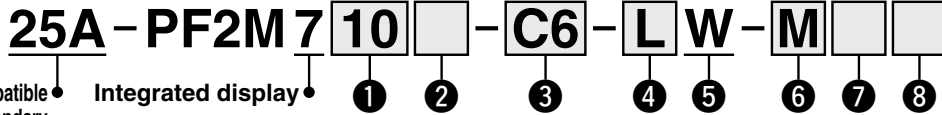

① Rated flow range

01	0.01 to 1 L/min	25	0.3 to 25 L/min
02	0.02 to 2 L/min	50	0.5 to 50 L/min
05	0.05 to 5 L/min	11	1 to 100 L/min
10	0.1 to 10 L/min	21	2 to 200 L/min

② Piping entry direction

Symbol	Piping entry direction	Rated flow range							
		1	2	5	10	25	50	100	200
Nil	Straight	●	●	●	●	●	●	●	●
L	Rear ported	●	●	●	●	●	●	●	●

③ Port size

Symbol	Port size	Rated flow range							
		1	2	5	10	25	50	100	200
01	Rc1/8	●	●	●	●	●	●	—	—
N1	NPT1/8	●	●	●	●	●	●	—	—
F1	G1/8	●	●	●	●	●	●	—	—
02	Rc1/4	—	—	—	—	—	—	●	●
N2	NPT1/4	—	—	—	—	—	—	●	●
F2	G1/4	—	—	—	—	—	—	●	●
C6	ø6	●	●	●	●	●	●	—	—
C8	ø8	—	—	—	—	—	—	●	●

Piping variations

With One-touch fitting	Female thread
C6, C8	01, 02, N1, N2, F1, F2
Straight	Straight
Rear ported	Rear ported

④ Output specification

Symbol	OUT1	OUT2
L	IO-Link/ NPN/PNP	—
L2	IO-Link/ NPN/PNP	NPN/PNP/External input
L3	IO-Link/ NPN/PNP	Analog 1 to 5 V ⇔ Analog 0 to 10 V*1
L4	IO-Link/ NPN/PNP	Analog 4 to 20 mA

*1 1 to 5 V or 0 to 10 V can be selected by pressing the button.
The default setting is 1 to 5 V.

⑤ Option 1

W

Lead wire with connector (2 m)
+
Connector cover (Silicone rubber)

ZS-33-F
ZS-33-D

* Interchangeable with the existing PFM7 series

⑥ Unit specification

M	SI unit only*2
Nil	Unit selection function*3

*2 Fixed unit: Instantaneous flow: L/min
Accumulated flow: L
*3 This product is for overseas use only.
(The SI unit type is provided for use in Japan in accordance with the New Measurement Act.)
The unit can be changed.
Instantaneous flow: L/min ⇔ cfm
Accumulated flow: L ⇔ ft³

⑧ Calibration certificate*4

Nil	None
A	Yes

*4 Made to order
The certificate is in both English and Japanese.

⑦ Option 2

Nil	R	T
	Bracket (For the type without a flow adjustment valve) 25A-ZS-33-M	Panel mount adapter (For the type without a flow adjustment valve) ZS-33-2J
Without bracket	With 2 tapping screws (3 x 6) 	Panel mount adapter Panel mount adapter B Panel Mounting bracket
	* Interchangeable with the existing PFM series	

* Options are shipped together with the product but do not come assembled.

Order separately

25A-ZS-33-DM-X558
M12 conversion lead wire

Connector M12 (Male)

Brown — ①
White — ②
Black — ③
Blue — ④

Wiring diagram

* The 25A-series specifications and dimensions are the same as those of the standard model.

For details, refer to the [Web Catalog](#).

2-Color Display

Digital Flow Switch

Integrated display



25A-PFM7 Series



How to Order

Integrated display

25A - PFM7 10 - C6 - A - M - W

Series compatible with secondary batteries

Type
7 Integrated display

Rated flow range (Flow rate range)

10	0.2 to 10 (5) L/min
25	0.5 to 25 (12.5) L/min
50	1 to 50 (25) L/min
11	2 to 100 (50) L/min

* (): Fluid: CO₂

Port size

Symbol	Description	Flow rate range			
		10	25	50	11
01	Rc1/8	●	●	●	—
02	Rc1/4	—	—	—	●
N01	NPT1/8	●	●	●	—
N02	NPT1/4	—	—	—	●
F01	G1/8	●	●	●	—
F02	G1/4	—	—	—	●
C6	ø6 One-touch fitting	●	●	●	●
C8	ø8 (5/16") One-touch fitting	—	●	●	●

Piping entry direction

Nil	Straight
L	Bottom

Output specifications

A	2 NPN outputs
B	2 PNP outputs
C	1 NPN output + Analog output (1 to 5 V)
D	1 NPN output + Analog output (4 to 20 mA)
E	1 PNP output + Analog output (1 to 5 V)
F	1 PNP output + Analog output (4 to 20 mA)
G	1 NPN output + External input ^{*3}
H	1 PNP output + External input ^{*3}

*3 User can select from accumulated value external reset, auto-shift and auto-shift zero.

Unit specifications

Nil	With unit switching function ^{*2}
M	Fixed SI unit ^{*1}

*1 Fixed unit: Instantaneous flow: L/min
Accumulated flow: L

*2 This product is for overseas use only. (The SI unit type is provided for use in Japan in accordance with the New Measurement Act.)

Option 1
W Lead wire with connector (2 m) + Rubber cover for connector (Silicon rubber)

Calibration certificate

Nil	None
A	With calibration certificate

* The certificate is written in both English and Japanese. Other languages are available as specials.

Operation manual

Nil	With operation manual (Japanese and English)
N	None

Option 2

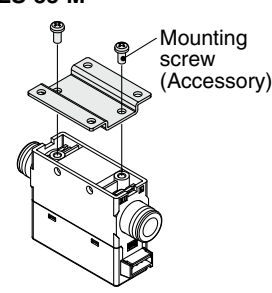
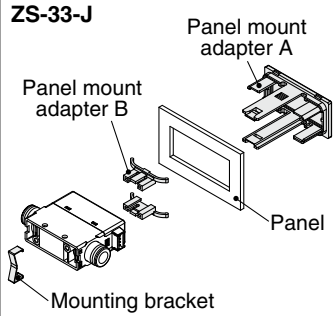
Nil	None
R	Bracket (For the type without a flow adjustment valve) 25A-ZS-33-M 
T	Panel mount adapter (For the type without a flow adjustment valve) ZS-33-J 

* The 25A- series specifications and dimensions are the same as those of the standard model.

* Digital flow switch with flow adjustment valve is not standard product. It can be supplied as Made-to-Order separately.

For details, refer to the [Web Catalog](#).

2-Color Display



Digital Flow Switch Remote sensor unit



25A-PFM5 Series



How to Order

Remote sensor unit **25A - PFM5 10 - C6** - **1** - **W**

Series compatible with secondary batteries

5 Remote sensor unit

Type

Rated flow range (Flow rate range)

10	0.2 to 10 (5) L/min
25	0.5 to 25 (12.5) L/min
50	1 to 50 (25) L/min
11	2 to 100 (50) L/min

* (): Fluid: CO₂

Piping entry direction

Nil	Straight
L	Bottom

Output specification

No.	Description	Applicable display unit
1	Analog output (1 to 5 V)	25A-PFM30□
2	Analog output (4 to 20 mA)	25A-PFM31□

Calibration certificate

Nil	None
A	With calibration certificate

* The certificate is written in both English and Japanese. Other languages are available as specials.

Operation manual

Nil	With operation manual (Japanese and English)
N	None

Option 1

With lead wire with connector (2 m)
+
Rubber cover for connector (silicon rubber)

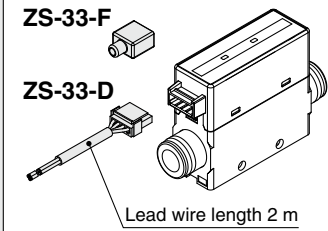

Option 2

Nil	R	T
None	<p>Bracket (For the type without a flow adjustment valve) 25A-ZS-33-M</p>	<p>Panel mount adapter (For the type without a flow adjustment valve) ZS-33-J</p>

Port size

Symbol	Description	Flow rate range			
		10	25	50	11
01	Rc1/8	●	●	●	
02	Rc1/4				●
N01	NPT1/8	●	●	●	
N02	NPT1/4				●
F01	G1/8*1	●	●	●	
F02	G1/4*1				●
C6	ø6 One-touch fitting	●	●	●	●
C8	ø8 (5/16") One-touch fitting		●	●	●

*1 ISO 228-1 compliant

Options are shipped together with the product but do not come assembled.

Piping Variations

	With One-touch fittings (C6, C8)		Female thread (01, 02, N01, N02, F01, F02)	
	Straight (Nil)	Bottom (L)	Straight (Nil)	Bottom (L)
Without flow adjustment valve (Nil)				

* The 25A-series specifications and dimensions are the same as those of the standard model. For details, refer to the [Web Catalog](#).

For 25A-PFM5



RoHS

Flow Sensor Monitor

25A-PFM3 Series



How to Order

Output specification

0	2 NPN outputs + 1 to 5 V output
1	2 NPN outputs + 4 to 20 mA output
2	2 NPN outputs + External input*1
3	2 PNP outputs + 1 to 5 V output
4	2 PNP outputs + 4 to 20 mA output
5	2 PNP outputs + External input*1

*1 User can select from accumulated value external reset, auto-shift and auto-shift zero.

Operation manual

Nil	With operation manual (Japanese and English)
N	None

Calibration certificate

Nil	None
A	With calibration certificate

* The certificate is written in both English and Japanese. Other languages are available as specials.

25A-PFM3 00-M L

Series compatible with secondary batteries

Type

3	Remote display unit
---	---------------------

Input specification

Symbol	Content	Applicable remote type sensor unit
0	Voltage input	25A-PFM5□□-□-1-□
1	Current input	25A-PFM5□□-□-2-□

Unit specification

Nil	With unit switching function*1
M	Fixed SI unit*2

*1 Under the New Measurement Act, flow sensor monitors with the unit switching function are not permitted for use in Japan.

*2 Fixed unit: Instantaneous flow: L/min
Accumulated flow: L

Option 1

Nil	None
L	Power supply/Output connector

* The cable does not come connected, but it is shipped together with the product.

Option 3

Nil	None
F	With sensor connector

* The connector does not come connected, but it is shipped together with the product.

Option 2

Nil	None
B	Panel mount adapter
D	Panel mount adapter + Front protective cover

* Options are shipped together with the product but do not come assembled.

Options/Part Nos.

Description	Part no.	Note
Power supply/Output connector (2 m)	ZS-28-A	
Sensor connector	ZS-28-C-1	1 pc.
Panel mount adapter	ZS-46-B	
Panel mount adapter + Front protective cover	ZS-46-D	

* The 25A-series specifications and dimensions are the same as those of the standard model.

For details, refer to the [Web Catalog](#).

2-Color Display



RoHS

Digital Flow Switch

25A-PFMB7 Series



How to Order

25A - PFMB7 **501** - **04** - **A** **W** - **M**

Series compatible with secondary batteries

Rated flow range (Flow rate range)

501	5 to 500 L/min
102	10 to 1000 L/min
202	20 to 2000 L/min

Thread type

Nil	Rc
N	NPT
F	G *1

*1 ISO 228 compliant

Port size

	Port size	Rated flow range		
		501	102	202
04	1/2	●	●	—
06	3/4	—	—	●

Output specification

	OUT1	OUT2	Applicable monitor unit model
A	NPN	NPN	—
B	PNP	PNP	—
C	NPN	Analog 1 to 5 V	PFG300 series
D	NPN	Analog 4 to 20 mA	PFG310 series
E *1	PNP	Analog 1 to 5 V	PFG300 series
F *1	PNP	Analog 4 to 20 mA	PFG310 series
G *1	NPN	External input *2	—
H *1	PNP	External input *2	—

*1 Made to order

*2 Accumulated flow value, peak/bottom flow value can be reset by external signal input.

Option 1

W

Lead wire with connector (2 m)
+
Rubber cover for connector (Silicone rubber)

ZS-33-F

ZS-33-D

* When only optional parts are required, refer to Option 1/Part Nos. below.

Calibration certificate *1

Nil	None
A *2	With calibration certificate

*1 The certificate is written in both English and Japanese.

*2 Made to order

Option 2

Nil	R
No bracket	With bracket

* Options are shipped together with the product but do not come assembled. When only optional parts are required, refer to Option 2/Part Nos. below.

Unit specification

M	SI unit only *1
Nil	Units selection function *2

*1 Fixed unit: Instantaneous flow: L/min
Accumulated flow: L

*2 This product is for overseas use only according to the New Measurement Act. (The SI unit type is provided for use in Japan.)

The unit can be changed. Instantaneous flow: L/min ⇔ ft³
Accumulated flow: L ⇔ ft³

Option 1/Part Nos.

Option	Part no.	Qty.	Note
Lead wire with connector	ZS-33-D	1	Lead wire: 2 m
Rubber cover (Silicone rubber)	ZS-33-F	1	For connector

Option 2/Part Nos.

Option	Part no.	Qty.	Note
Bracket (for PFMB7201)	25A-ZS-33-M	1	With 2 tapping screws (3 x 6)
Panel mount adapter (for PFMB7201)	ZS-33-J	1	
Bracket (for PFMB7501/7102)	25A-ZS-42-C	1	With 4 tapping screws (3 x 6)
Bracket (for PFMB7202)	25A-ZS-42-D	1	With 4 tapping screws (3 x 6)

* The 25A-series specifications and dimensions are the same as those of the standard model. For details, refer to the [Web Catalog](#).

Body Ported Type

3-Color Display Digital Flow Switch

25A-PF3A7□H Series

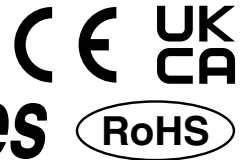

How to Order

25A - PF3A 7 03 H - □ 10 - CS □ - M □

Series compatible with secondary batteries

Type

7	Integrated display
---	--------------------

Rated flow range

03	30 to 3000 L/min
06	60 to 6000 L/min
12	120 to 12000 L/min

Large flow type

Thread type

Nil	Rc
N	NPT
F*1	G

*1 ISO 1179-1 compliant

Port size

Symbol	Port size	Rated flow range		
		03	06	12
10	1	●	—	—
14	1 1/2	—	●	—
20	2	—	—	●

Calibration certificate*8

Nil	None
A*9	Yes

*8 The certificate is in both English and Japanese.

*9 Made to order

Unit specification

Nil	Units selection function*6
M	SI units only*7

*6 This product is for overseas use only. (The SI unit type is provided for use in Japan in accordance with the New Measurement Act.)

*7 Fixed units: Instantaneous flow: L/min
Accumulated flow: L

Options

Nil	With lead wire with M12 connector (3 m)*5
N	Without lead wire with M12 connector

*5 Options are shipped together with the product but do not come assembled.

Output specification

Symbol	OUT	FUNC*2	Applicable monitor unit model
CS	NPN	Analog voltage output*3 ↔ External input*4	PFG300 series
DS	NPN	Analog current output ↔ External input*4	PFG310 series
ES	PNP	Analog voltage output*3 ↔ External input*4	PFG300 series
FS	PNP	Analog current output ↔ External input*4	PFG310 series

*2 Analog output or external input can be selected by pressing the buttons. Analog output is set as default setting.

*3 1 to 5 V or 0 to 10 V can be selected by pressing the button. The default setting is 1 to 5 V.

*4 The accumulated value, peak value, and bottom value can be reset.

Option/Part No.

When only optional parts are required, order with the part number listed below.

Part no.	Option	Note
90-ZS-37-A-X258	Lead wire with M12 connector	Length: 3 m

* The 25A- series specifications and dimensions are the same as those of the standard model.

For details, refer to the [Web Catalog](#).

Body Ported Type  IO-Link

3-Color Display Digital Flow Switch

25A-PF3A7□H-L Series

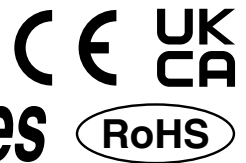

How to Order

25A - PF3A 7 03 H - □ 10 - L □ - M □

Series compatible with secondary batteries

Type

7	Integrated display
---	--------------------

Rated flow range

03	30 to 3000 L/min
06	60 to 6000 L/min
12	120 to 12000 L/min

Large flow type

Thread type

Nil	Rc
N	NPT
F*1	G

*1 ISO 1179-1 compliant

Port size

Symbol	Port size	Rated flow range		
		03	06	12
10	1	●	—	—
14	1 1/2	—	●	—
20	2	—	—	●

Calibration certificate*8

Nil	None
A*9	Yes

*8 The certificate is in both English and Japanese.

*9 Made to order

Unit specification

Nil	Units selection function*6
M	SI units only*7

*6 This product is for overseas use only. (The SI unit type is provided for use in Japan in accordance with the New Measurement Act.)

*7 Fixed units: Instantaneous flow: L/min
Accumulated flow: L

Options

Nil	With lead wire with M12 connector (3 m)*5
N	Without lead wire with M12 connector

*5 Options are shipped together with the product but do not come assembled.

Output specification

Symbol	OUT	FUNC*2	Applicable monitor unit model
L	IO-Link: Switch output (N/P)	—	—
L3	IO-Link: Switch output (N/P)	Analog voltage output*3 ⇔ External input*4	PFG300 series
L4	IO-Link: Switch output (N/P)	Analog current output ⇔ External input*4	PFG310 series

*2 Analog output or external input can be selected by pressing the buttons. Analog output is set as default setting.

Output symbol "L" cannot be used as the FUNC terminal is not connected.

*3 1 to 5 V or 0 to 10 V can be selected by pressing the button. The default setting is 1 to 5 V.

*4 The accumulated value, peak value, and bottom value can be reset.

Options/Part Nos.

When only optional parts are required, order with the part numbers listed below.

Part no.	Option	Note
90-ZS-37-A-X258	Lead wire with M12 connector	Length: 3 m

* The 25A- series specifications and dimensions are the same as those of the standard model.

For details, refer to the [Web Catalog](#).

3-Color Display Digital Flow Switch for Water RoHS

25A-PF3W7-Z Series

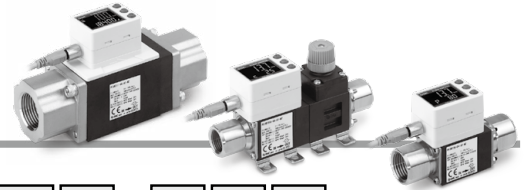

How to Order

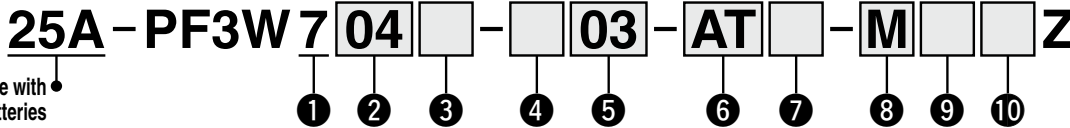

Series compatible with secondary batteries

1 Type

7 Integrated display

2 Rated flow range (Flow range)

Symbol	Rated flow range
04	0.5 to 4 L/min
20	2 to 16 L/min
40	5 to 40 L/min
11	10 to 100 L/min

3 Flow adjustment valve

Symbol	With/without flow adjustment valve	Rated flow range			
		04	20	40	11
Nil	None	●	●	●	●
S	Yes	●	●	●	—

* 100 L/min type with flow adjustment valve is not available.

* The flow adjustment valve of this product is not suitable for applications which require constant adjustment of flow rate.

4 Thread type

Nil	Rc
N	NPT
F	G*1

*1 ISO 228 compliant

5 Port size

Symbol	Port size	Rated flow range			
		04	20	40	11
03	3/8	●	●	—	—
04	1/2	—	●	●	—
06	3/4	—	—	●	●
10	1/1	—	—	—	●

7 Lead wire (Option)

Nil	N
With lead wire with M8 connector (3 m)	Without lead wire with M8 connector

6 Output specification/Temperature sensor

Symbol	OUT1	OUT2		Temperature sensor	
	Flow rate	Flow rate	Temperature		
A	NPN	NPN	—	None	
B	PNP	PNP	—		
C	NPN	Analog 1 to 5 V	—		
D	NPN	Analog 4 to 20 mA	—		
E	PNP	Analog 1 to 5 V	—		
F	PNP	Analog 4 to 20 mA	—		
G	NPN	External input*1	—		
H	PNP	External input*1	—		
AT	NPN	(NPN)	*2 NPN		With temperature sensor
BT	PNP	(PNP)	*2 PNP		
CT	NPN	(Analog 1 to 5 V)	*2 Analog 1 to 5 V		
DT	NPN	(Analog 4 to 20 mA)	*2 Analog 4 to 20 mA		
ET	PNP	(Analog 1 to 5 V)	*2 Analog 1 to 5 V		
FT	PNP	(Analog 4 to 20 mA)	*2 Analog 4 to 20 mA		

*1 External input: The accumulated value, peak value, and bottom value can be reset.

*2 For units with temperature sensor, only OUT2 can be set as either temperature output or flow rate output. Setting when shipped is for temperature output.

8 Integrated display/Unit specification

Symbol	Instantaneous flow	Accumulated flow	Temperature
M	L/min	L	°C
G	gal/min	gal	°C
F	gal/min	gal	°F
J	L/min	L	°F

* Under the New Measurement Act, units other than SI (symbol "M") cannot be used in Japan.

* G, F, J: Made to order

Reference: 1 [L/min] ↔ 0.2642 [gal/min]

1 [gal/min] ↔ 3.785 [L/min]

°F = 9/5°C + 32

9 Bracket (Option)

Nil	None
R	With bracket

10 Calibration certificate (Only for flow rate)

Nil	None
A	With calibration certificate

* The certificate is written in both Japanese and English.

Units with temperature sensor can only display the flow rate.

Options/Part Nos.

When only optional parts are required, order with the part numbers listed below.

Description	Part no.	Qty.	Note
Bracket*1	25A-ZS-40-K	1	For PF3W704/720/504/520 With 4 tapping screws (3 x 8)
	25A-ZS-40-L	1	For PF3W740/540 With 4 tapping screws (3 x 8)
	25A-ZS-40-M	1	For PF3W711/511 With 4 tapping screws (4 x 10)
Lead wire with M8 connector	25A-ZS-40-A	1	Lead wire length: 3 m

*1 For units with flow adjustment valve, 2 brackets are required.

* The 25A-series specifications and dimensions are the same as those of the standard model.

For details, refer to the [Web Catalog](#).

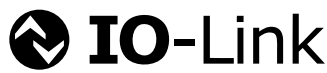

Integrated Display



3-Color Display

Digital Flow Switch for Water

RoHS

25A-PF3W7-L Series

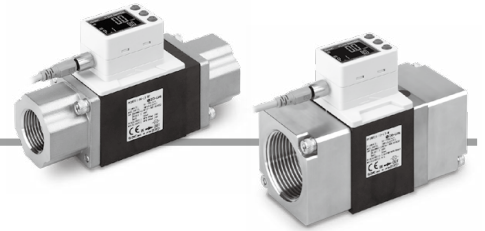

How to Order

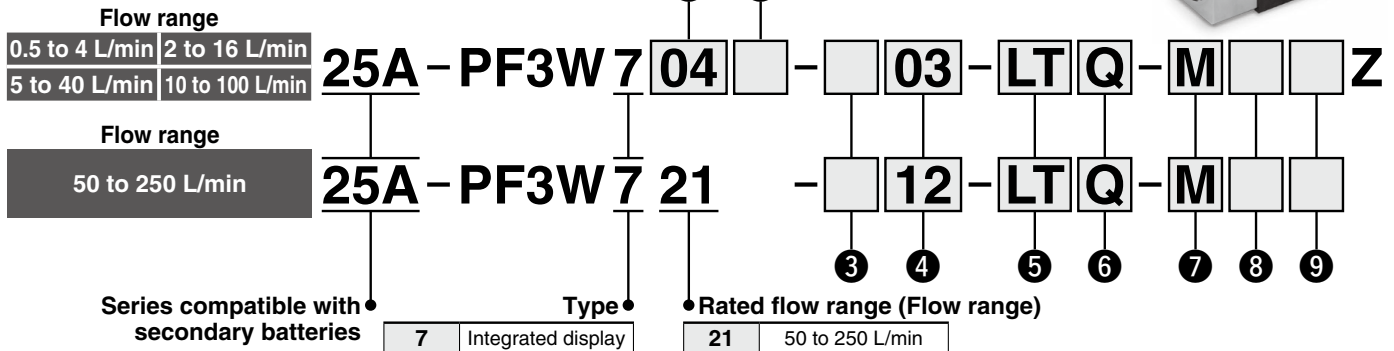

① Rated flow range (Flow range)

04	0.5 to 4 L/min
20	2 to 16 L/min
40	5 to 40 L/min
11	10 to 100 L/min

② Flow adjustment valve

Symbol	With/without flow adjustment valve	Rated flow range			
		04	20	40	11
Nil	None	●	●	●	●
S	Yes	●	●	●	—

- * 100 L/min type with a flow adjustment valve is not available.
- * The flow adjustment valve of this product is not suitable for applications which require the constant adjustment of the flow rate.

③ Thread type

Nil	Rc
N	NPT
F	G*1

*1 ISO 228 compliant

④ Piping port size

Symbol	Port size	Rated flow range				
		04	20	40	11	21
03	3/8	●	●	—	—	—
04	1/2	—	—	●	—	—
06	3/4	—	—	●	●	—
10	1	—	—	—	●	—
12	1-1/4	—	—	—	—	●
14	1-1/2	—	—	—	—	●

⑤ Output specification/Temperature sensor

Symbol	OUT1		OUT2	Temperature sensor
	Flow rate/Temperature		Flow rate/Temperature	
L	IO-Link/Switch output (N/P)		—	None
L2	IO-Link/Switch output (N/P)		Switch output (N/P)	
LT	IO-Link/Switch output (N/P)		—	Yes
L2T	IO-Link/Switch output (N/P)		Switch output (N/P)	

- * Temperature output or flow output can be selected for the digital flow switch with a temperature sensor.
- * The output specification of L, L2, and L2T should be ordered as made to order.

⑥ Lead wire (Option)

Nil	With lead wire with M8 connector (3 m)
N	None
Q	With M12-M8 conversion lead wire (0.1 m)*1

- *1 A 3 m lead wire is also available separately.
- * The lead wire with M8 connector and the M12-M8 conversion lead wire are interchangeable with the existing PF3W series.

⑦ Integrated display/Unit specification

Symbol	Instantaneous flow	Accumulated flow	Temperature
Nil	With display unit switching function	—	°C
M	L/min	L	°C

- * Under the New Measurement Act, units other than SI (symbol "M") cannot be used in Japan. Unit can be changed.
Instantaneous flow: L/min ↔ gal/min
Accumulated flow : L ↔ gal
- * Reference: 1 [L/min] ↔ 0.2642 [gal/min]
1 [gal/min] ↔ 3.785 [L/min]

⑧ Brackets (Option)

Nil	None
R	With brackets

- * Brackets are interchangeable with the existing PF3W series.

⑨ Calibration certificate (Only for flow rate)

Nil	None
A	With calibration certificate

- * The certificate is written in both Japanese and English. The integrated display type with a temperature sensor can only display the flow rate. The temperature sensor is not calibrated.

Options/Part Nos.

When only optional parts are required, order with the part numbers listed below.

Description	Part no.	Qty.	Note
Bracket*1	25A-ZS-40-K	1	For PF3W704/720/504/520 With 4 tapping screws (3 x 8)
	25A-ZS-40-L	1	For PF3W740/540 With 4 tapping screws (3 x 8)
	25A-ZS-40-M	1	For PF3W711/511 With 4 tapping screws (4 x 10)
Lead wire with M8 connector	25A-ZS-40-A	1	Lead wire length: 3 m
M12-M8 conversion lead wire	25A-ZS-40-M12M8-A	1	Length 100 mm

- *1 For units with flow adjustment valve, 2 brackets are required.

- * The 25A- series specifications and dimensions are the same as those of the standard model.

For details, refer to the [Web Catalog](#).



3-Color Display Digital Flow Switch for Water (RoHS)
25A-PF3W5-Z Series

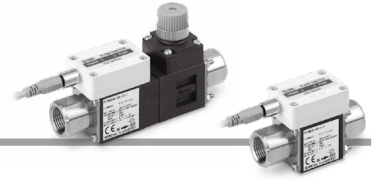

How to Order

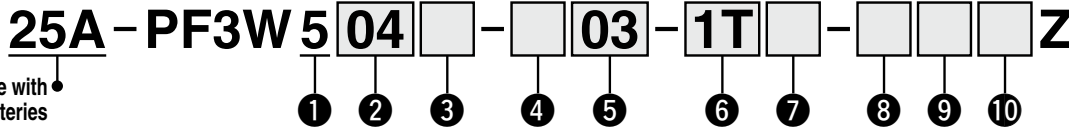

Series compatible with secondary batteries

1 Type

5	Remote sensor unit
---	--------------------

2 Rated flow range (Flow range)

Symbol	Rated flow range
04	0.5 to 4 L/min
20	2 to 16 L/min
40	5 to 40 L/min
11	10 to 100 L/min

3 Flow adjustment valve

Symbol	With/without flow adjustment valve	Rated flow range			
		04	20	40	11
Nil	None	●	●	●	●
S	Yes	●	●	●	—

* 100 L/min type with flow adjustment valve is not available.

* The flow adjustment valve of this product is not suitable for applications which require constant adjustment of flow rate.

4 Thread type

Nil	Rc
N	NPT
F	G*1

*1 ISO 228 compliant

5 Port size

Symbol	Port size	Rated flow range			
		04	20	40	11
03	3/8	●	●	—	—
04	1/2	—	●	●	—
06	3/4	—	—	●	●
10	1/1	—	—	—	●

6 Output specification/Temperature sensor

Symbol	OUT1	OUT2	Temperature sensor
	Flow rate	Temperature	
1	Analog 1 to 5 V	—	None
2	Analog 4 to 20 mA	—	
1T	Analog 1 to 5 V	Analog 1 to 5 V	With temperature sensor

* To use in combination with remote monitor (PF3W3 series), select analog output of 1 to 5 V of flow rate (output symbol “-1” or “-1T”).

7 Lead wire (Option)

Nil	With lead wire with M8 connector (3 m)
N	Without lead wire with M8 connector

8 Remote sensor unit/Unit printed on label

Symbol	Instantaneous flow	Temperature
Nil	L/min	°C
G*1	L/min (gal/min)	°C/°F

*1 Under the New Measurement Act, units other than SI (symbol “Nil”) cannot be used in Japan.

* G: Made to order

Reference: 1 [L/min] ↔ 0.2642 [gal/min]
 1 [gal/min] ↔ 3.785 [L/min]
 °F = 9/5°C + 32

9 Bracket (Option)

Nil	None
R	With bracket

10 Calibration certificate (Only for flow rate)

Nil	None
A	With calibration certificate

* The certificate is written in both Japanese and English.

Units with temperature sensor can only display the flow rate.

Options/Part Nos.

When only optional parts are required, order with the part numbers listed below.

Description	Part no.	Qty.	Note
Bracket*1	25A-ZS-40-K	1	For PF3W704/720/504/520 With 4 tapping screws (3 x 8)
	25A-ZS-40-L	1	For PF3W740/540 With 4 tapping screws (3 x 8)
	25A-ZS-40-M	1	For PF3W711/511 With 4 tapping screws (4 x 10)
Lead wire with M8 connector	25A-ZS-40-A	1	Lead wire length: 3 m

*1 For units with flow adjustment valve, 2 brackets are required.

* The 25A-series specifications and dimensions are the same as those of the standard model.

For details, refer to the [Web Catalog](#).

3-color display

Digital Flow Switch for Water

25A-PF3W Series



How to Order

Remote sensor unit

Output specification/Temperature sensor

Symbol	OUT1	OUT2	Temperature sensor
	Flow rate	Temperature	
1	Analog 1 to 5 V	—	None
2	Analog 4 to 20 mA	—	
1T	Analog 1 to 5 V	Analog 1 to 5 V	

* To use in combination with remote monitor (PF3W3 series), select analog output of 1 to 5 V of flow rate (output symbol "1" or "1T").

Remote sensor unit/Unit printed on label

Symbol	Instantaneous flow rate	Temperature
Nil	L/min	°C
G*1	L/min (gal/min)	°C/°F

*1 Under the New Measurement Act, units other than SI (symbol: "Nil") cannot be used in Japan.
 * G: Made to Order
 Reference: 1 [L/min] ↔ 0.2642 [gal/min]
 1 [gal/min] ↔ 3.785 [L/min]
 °F = 9/5°C + 32



Remote sensor unit

Integrated display

Series compatible with secondary batteries



Rated flow range (Flow range)

Symbol	Rated flow range
04	0.5 to 4 L/min
20	2 to 16 L/min
40	5 to 40 L/min
11	10 to 100 L/min
21	50 to 250 L/min

Flow adjustment valve

Symbol	With/without flow adjustment valve	Rated flow rate				
		04	20	40	11	21
Nil	None	●	●	●	●	●
S	Yes	●	●	●	—	—

* 100 and 250 L/min types with flow adjustment valves are not available.
 * The flow adjustment valve of this product is not suitable for applications which require constant adjustment of flow rate.

* The 25A-series specifications and dimensions are the same as those of the standard model.
 For details, refer to the [Web Catalog](#).

*1 External input: The accumulated value, peak value, and bottom value can be reset.

*2 For units with temperature sensor, OUT2 can be set as either temperature output or flow rate output. Setting when shipped is for temperature output.

Symbol	OUT1	OUT2		Temperature sensor
	Flow rate	Flow rate	Temperature	
A	NPN	NPN	—	None
B	PNP	PNP	—	
C	NPN	Analog 1 to 5 V	—	
D	NPN	Analog 4 to 20 mA	—	
E	PNP	Analog 1 to 5 V	—	
F	PNP	Analog 4 to 20 mA	—	
G	NPN	External input*1	—	
H	PNP	External input*1	—	
AT	NPN	(NPN) ↔*2	NPN	With temperature sensor
BT	PNP	(PNP) ↔*2	PNP	
CT	NPN	(Analog 1 to 5 V) ↔*2	Analog 1 to 5 V	
DT	NPN	(Analog 4 to 20 mA) ↔*2	Analog 4 to 20 mA	
ET	PNP	(Analog 1 to 5 V) ↔*2	Analog 1 to 5 V	
FT	PNP	(Analog 4 to 20 mA) ↔*2	Analog 4 to 20 mA	

Options/Part Nos.

When only optional parts are required, order with the part numbers listed below.

Description	Part no	Qty.	Note
Bracket*1	25A-ZS-40-K	1	For PF3W704/720/504/520 With 4 tapping screws (3 x 8)
	25A-ZS-40-L	1	For PF3W740/540 With 4 tapping screws (3 x 8)
	25A-ZS-40-M	1	For PF3W711/511 With 4 tapping screws (4 x 10)
Lead wire with M8 connector	25A-ZS-40-A	1	Lead wire length (3 m)

*1 For units with flow adjustment valve, 2 brackets are required.

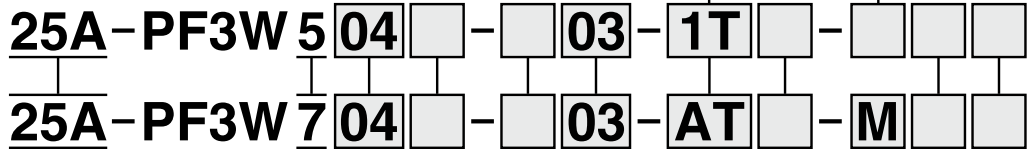

Type

5	Remote sensor unit
7	Integrated display

Thread type

Nil	Rc
N	NPT
F	G

Port size

Symbol	Port size	Rated flow range				
		04	20	40	11	21
03	3/8	●	●	—	—	—
04	1/2	—	●	●	—	—
06	3/4	—	—	●	●	—
10	1/1	—	—	—	●	—
12	1 1/4	—	—	—	—	●
14	1 1/2	—	—	—	—	●

Integrated display

Output specification/ Temperature sensor

Calibration certificate (Only flow sensor)

Nil	None
A	With calibration certificate

* The certificate is written in both English and Japanese. Integrated display type with temperature sensor can only display flow rate.

Bracket (Option)

Nil	None
R	Bracket

* With bracket is not available for 250 L/min type.

Integrated display/Unit specification

Symbol	Instantaneous flow rate	Accumulated flow	Temperature
M	L/min	L	°C
G	gal/min	gal	°C
F	gal/min	gal	°F
J	L/min	L	°F

* Under the New Measurement Act, units other than SI (symbol: "M") cannot be used in Japan.

* G, F, J: Made to Order
 Reference: 1 [L/min] ↔ 0.2642 [gal/min]
 1 [gal/min] ↔ 3.785 [L/min]
 °F = 9/5°C + 32

Lead wire (Option)

Nil	N
With lead wire with M8 connector (3 m)	Without lead wire with M8 connector

* The 25A-series specifications and dimensions are the same as those of the standard model.

For details, refer to the [Web Catalog](#).

3-color display

Digital Flow Switch for PVC Piping

25A-PF3W Series



How to Order

Remote sensor unit

Output specification

Symbol	OUT1
1	Analog 1 to 5 V
2	Analog 4 to 20 mA

* To use in combination with remote monitor (PF3W3 series), select analog output of 1 to 5 V of flow rate (output symbol "-1").



Remote sensor unit/Unit printed on label

Symbol	Instantaneous flow rate
Nil	L/min
G*1	L/min (gal/min)

*1 Under the New Measurement Act, units other than SI (symbol: "Nil") cannot be used in Japan.

* G: Made to Order

Reference: 1 [L/min] ↔ 0.2642 [gal/min]
1 [gal/min] ↔ 3.785 [L/min]

Calibration certificate (Only flow sensor)

Nil	None
A	With calibration certificate

* The certificate is written in both English and Japanese.

Remote sensor unit

Integrated display

Series compatible with secondary batteries



25A - PF3W 5 11 - U 25 - 1

25A - PF3W 7 11 - U 25 - A

Type

5	Remote sensor unit
7	Integrated display

Rated flow range (Flow range)

Symbol	Rated flow range
11	10 to 100 L/min
21	30 to 250 L/min

Connection type

U	PVC pipe
---	----------

PVC pipe O.D.

Symbol	Port size	Rated flow range		Pipe O.D.*1
		11	21	
25	25A	●	—	32 mm
30	30A	—	●	38 mm

*1 JIS K 6742 equivalent

Bracket (Option)

Nil	None
R	Bracket

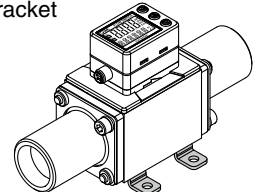

* With bracket is not available for 250 L/min type.

Integrated display/Unit specification

Symbol	Instantaneous flow rate	Accumulated flow
M	L/min	L
G	gal/min	gal

* Under the New Measurement Act, units other than SI (symbol: "M") cannot be used in Japan.

* G: Made to Order

Reference: 1 [L/min] ↔ 0.2642 [gal/min]
1 [gal/min] ↔ 3.785 [L/min]

Integrated display Output specification

Symbol	OUT1	OUT2
A	NPN	NPN
B	PNP	PNP
C	NPN	Analog 1 to 5 V
D	NPN	Analog 4 to 20 mA
E	PNP	Analog 1 to 5 V
F	PNP	Analog 4 to 20 mA
G	NPN	External input*1
H	PNP	External input*1

* The 25A- series specifications and dimensions are the same as those of the standard model.

For details, refer to the [Web Catalog](#).

*1 External input: The accumulated value, peak value, and bottom value can be reset.

Lead wire

Nil	N
With lead wire with M8 connector (3 m)	Without lead wire with M8 connector

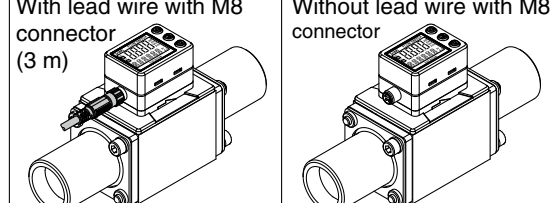

Options/Part Nos.

When only optional parts are required, order with the part numbers listed below.

Description	Part no.	Qty.	Note
Bracket	25A-ZS-40-M	1	For PF3W711/511 With 4 tapping screws (4 x 10)
Lead wire with M8 connector	25A-ZS-40-A	1	Lead wire length (3 m)

* The 25A- series specifications and dimensions are the same as those of the standard model.

For details, refer to the [Web Catalog](#).

For 25A-PF3W5(-Z)

3-Color Display



Digital Flow Monitor for Water



25A-PF3W Series



How to Order

25A-PF3W 30 A - **M V C**

Series compatible with secondary batteries

Type

3 Remote monitor unit

For remote sensor units, select the analog output 1 to 5 V type.
Applicable sensors: PF3W5□□-□□-1(T)

Output specification

Symbol	OUT1	OUT2
A	NPN	NPN
B	PNP	PNP
C	NPN	Analog 1 to 5 V
D	NPN	Analog 4 to 20 mA
E	PNP	Analog 1 to 5 V
F	PNP	Analog 4 to 20 mA
G	NPN	External input
H	PNP	External input
J	Analog 1 to 5 V	Analog 1 to 5 V
K	Analog 4 to 20 mA	Analog 4 to 20 mA

In combination with remote sensor unit with temperature sensor, only OUT2 can be set for temperature sensor output.

Lead wire

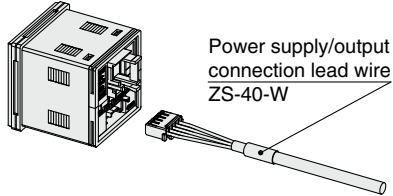
Nil	With power supply/output connection lead wire (2 m) 
N	Without power supply/output connection lead wire

The lead wire does not come connected, but it is shipped together with the product.

Remote monitor unit/Unit specification

Symbol	Instantaneous flow	Accumulated flow	Temperature
M	L/min	L	°C
G	gal/min	gal	°C
F	gal/min	gal	°F
J	L/min	L	°F

* Under the New Measurement Act, units other than SI (symbol "M") cannot be used in Japan.

* G, F, J: Made to order

Reference: 1 [L/min] ↔ 0.2642 [gal/min]
1 [gal/min] ↔ 3.785 [L/min]
°F = 9/5°C + 32

Calibration certificate (Only flow monitor)

Nil	None
A	With calibration certificate

* The certificate is written in both Japanese and English.

Option 2

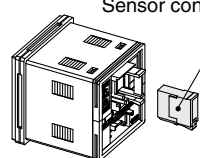
Nil	None
C	Sensor connector (1 pc.)  Sensor connector (e-con)

The connector does not come connected, but it is shipped together with the product.

Option 1

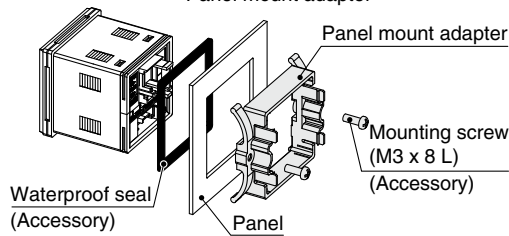
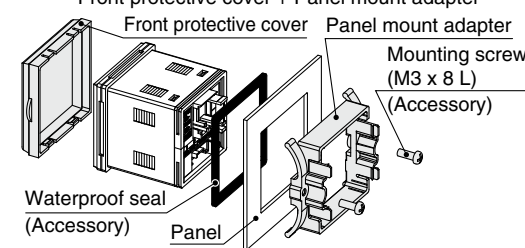
Nil	None
T	Panel mount adapter  Waterproof seal (Accessory) Panel mount adapter Mounting screw (M3 x 8 L) (Accessory) Panel
V	Front protective cover + Panel mount adapter  Front protective cover Panel mount adapter Mounting screw (M3 x 8 L) (Accessory) Waterproof seal (Accessory) Panel

Options/Part Nos.

When only optional parts are required, order with the part numbers listed below.

Description	Part no.	Note
Panel mount adapter	25A-ZS-26-B	With waterproof seal and screws
Front protective cover + Panel mount adapter	25A-ZS-26-C	With waterproof seal and screws
Front protective cover only	ZS-26-01	Separately order panel mount adapter, etc.
Power supply/output connection lead wire	ZS-40-W	Lead wire length: 2 m
Sensor connector (e-con)	ZS-28-CA-4	1 pc.
Lead wire with connector for copying	ZS-40-Y	Connect up to 10 copy destination units

* The 25A- series specifications and dimensions are the same as those of the standard model. For details, refer to the [Web Catalog](#).