

Ejector System Vacuum Unit

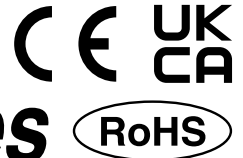

25A-ZK2□A Series

Single Unit Ejector + With Valve + Without Energy Saving Function

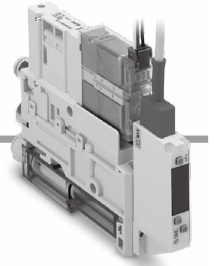

How to Order

25A-ZK2 **A** **12** **K** **5** **A** **L** **A** - **08** - □

1 2 3 4 5 6 7 8

1 Body/Exhaust type

Symbol	Body	Exhaust type
A	Single unit	Silencer exhaust*1
		Port exhaust
B	Single unit	High-noise reduction silencer exhaust

*1 With exhaust port when 2 is 12 or 15

4 Rated voltage (Supply valve/Release valve)

Symbol	Voltage
5	24 VDC
6	12 VDC

5 Pressure switch for vacuum/Pressure sensor

Symbol	Type	Pressure range [kPa]	Specifications		
			NPN	PNP	With unit selection function*3
A	Pressure switch for vacuum	0 to -101	●	—	●
B			●	—	None (SI unit only)
C			—	●	●
D		-100 to 100	—	●	None (SI unit only)
E			●	—	●
F			●	—	None (SI unit only)
H	—	●	●		
J	—	●	None (SI unit only)		
P	Pressure sensor	0 to -101	Analog output 1 to 5 V		
T		-100 to 100			
N	Without pressure switch for vacuum/pressure sensor				

*3 The unit selection function is not available in Japan due to the New Measurement Law. The unit for the type without the unit selection function is fixed as kPa.

7 Vacuum (V) port

Symbol	Vacuum (V) port
06	ø6
08	ø8

2 Nominal nozzle size

Symbol	Nominal nozzle size
07	ø0.7
10	ø1.0
12	ø1.2
15	ø1.5

* The standard supply pressure of each nozzle diameter is the same as that of the corresponding standard product.

For details, refer to the [Web Catalog](#).

3 Combination of supply valve and release valve

Symbol	Supply valve		Release valve
	N.C.	Self-holding	N.C.
K	●	—	●
J	●	—	—
R	—	●*2	●

*2 Supply valve maintains vacuum by energization (20 ms or more). Stopping the vacuum turns on the release valve.

6 Connector (Supply valve/Release valve/Pressure switch for vacuum)

Symbol	For supply valve/ release valve: 300 mm (Connector assembly)*4	For pressure switch for vacuum: 2 m (Lead wire with connector)	Pressure sensor assembly: 3 m (With lead wire)	Note
L	●	—	●	Cannot be selected when 5 is N
L1	None	—	●	
L2	●	—	None	Cannot be selected when 5 is P or T
L3	None	—	None	

*4 For the connector length other than 300 mm, select L1 or L3, and order the connector assembly on page 194 separately.

8 Option*5 (For details on the Function/Application, refer to page 195.)

Symbol	Type	Note
Nil	Without option	—
B	Mounting bracket for single unit (nuts and bolts are included) 	—
D	With individual release pressure supply (PD) port (M3)*6 	Cannot be selected when 3 is J
E	Vacuum break flow adjusting needle Screwdriver operation type long lock nut 	Cannot be selected when 3 is J
J	Round lock nut Lock nut 	
K	Vacuum break flow adjusting needle Screwdriver operation type 	Can be selected only for the combination of J and K
W	With exhaust interference prevention valve 	When J is selected for 8, install the release valve or vacuum breaker in the middle of the vacuum piping.

*5 When more than one option is selected, list the option symbols in alphabetical order. (Example -BJ)

*6 Use a One-touch fitting or barb fitting for piping. (O.D.: Within ø6.2)

* The 25A-series specifications and dimensions are the same as those of the standard model.

The manifold type is available as a special order.

For details, refer to the [Web Catalog](#).

Ejector System Vacuum Unit

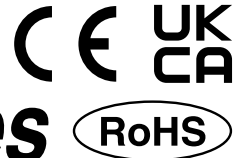

25A-ZK2□A Series

Single Unit Ejector + With Valve + With Energy Saving Function

How to Order

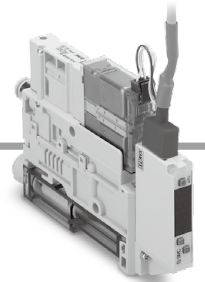

25A-ZK2 **A** **12** **K** **5** **K** **W** **A** - **08** - □

①
②
③
④
⑤
⑥
⑦
⑧

① Body/Exhaust type

Symbol	Body	Exhaust type
A	Single unit	Silencer exhaust*1
		Port exhaust
G	Single unit	High-noise reduction silencer exhaust

*1 With exhaust port when ② is 12 or 15

② Nominal nozzle size

Symbol	Nominal nozzle size
07	ø0.7
10	ø1.0
12	ø1.2
15	ø1.5

* The standard supply pressure of each nozzle diameter is the same as that of the corresponding standard product.
For details, refer to the [Web Catalog](#).

③ Combination of supply valve and release valve

Symbol	Supply valve	Release valve
	N.C.	N.C.
K	●	●

④ Rated voltage (Supply valve/Release valve)

Symbol	Voltage
5	24 VDC
6	12 VDC

⑤ Pressure switch for vacuum with energy saving function

Symbol	Pressure range [kPa]	Specifications		
		NPN	PNP	With unit selection function*2
K	-100 to 100	●	—	●
Q		●	—	None (SI unit only)
R		—	●	●
S		—	●	None (SI unit only)

*2 The unit selection function is not available in Japan due to the New Measurement Law. The unit for the type without the unit selection function is fixed as kPa.

⑥ Connector

Symbol	For pressure switch for vacuum with energy saving function: 2 m (Lead wire with connector)
W	●
L3	None

⑦ Vacuum (V) port

Symbol	Vacuum (V) port
06	ø6
08	ø8

⑧ Option*3 (For details on the Function/Application, refer to page 195.)

Symbol	Type	Note
Nil	Without option	—
B	Mounting bracket for single unit (nuts and bolts are included) 	—
D	With individual release pressure supply (PD) port (M3)*4 	—
E	Screwdriver operation type long lock nut 	Can be selected only for the combination of J and K
J	Round lock nut 	
K	Screwdriver operation type Vacuum break flow adjusting needle 	

*3 When more than one option is selected, list the option symbols in alphabetical order. (Example -BJ)

*4 Use a One-touch fitting or barb fitting for piping. (O.D.: Within ø6.2)

The manifold type is available as a special order.

* The 25A- series specifications and dimensions are the same as those of the standard model.

For details, refer to the [Web Catalog](#).

25A-ZK2□A Series

Single Unit Ejector + Without Valve + Without Energy Saving Function

How to Order

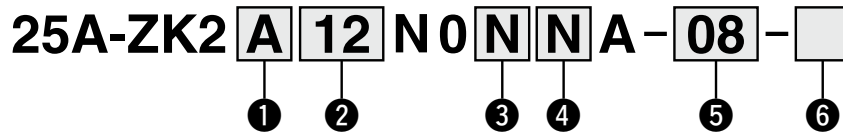
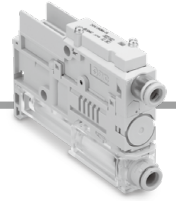

① Body/Exhaust type

Symbol	Body	Exhaust type
A	Single unit	Silencer exhaust* ¹
B		Port exhaust
G		High-noise reduction silencer exhaust High-noise reduction silencer exhaust

*1 With exhaust port when ② is 12 or 15

② Nominal nozzle size

Symbol	Nominal nozzle size
07	ø0.7
10	ø1.0
12	ø1.2
15	ø1.5

* The standard supply pressure of each nozzle diameter is the same as that of the corresponding standard product.
For details, refer to the [Web Catalog](#).

④ Connector

Symbol	For pressure switch for vacuum: 2 m (Lead wire with connector)	Pressure sensor assembly: 3 m (With lead wire)	Note
Y	●		Cannot be selected when ③ is N
Y1	None		Cannot be selected when ③ is P, T, or N
N	None		When "N" is selected for ③

③ Pressure switch for vacuum/Pressure sensor

Symbol	Type	Pressure range [kPa]	Specifications		
			NPN 2 outputs	PNP	With unit selection function* ²
A	Pressure switch for vacuum	0 to -101	●	—	●
B			●	—	None (SI unit only)
C			—	●	●
D		—	●	None (SI unit only)	
E		-100 to 100	●	—	●
F			●	—	None (SI unit only)
H	—		●	●	
J	—	—	●	None (SI unit only)	
P	Pressure sensor	0 to -101	Analog output 1 to 5 V		
T		-100 to 100			
N	Without pressure switch for vacuum/pressure sensor				

*2 The unit selection function is not available in Japan due to the New Measurement Law. The unit for the type without the unit selection function is fixed as kPa.

⑤ Vacuum (V) port

Symbol	Vacuum (V) port
06	ø6
08	ø8

⑥ Option*³ (For details on the Function/Application, refer to page 195.)

Symbol	Type	Note
Nil	Without option	—
B	Mounting bracket for single unit (nuts and bolts are included) 	—
W	With exhaust interference prevention valve 	Install the release valve or vacuum breaker in the middle of the vacuum piping.

*3 When more than one option is selected, list the option symbols in alphabetical order. (Example -BW)

The manifold type is available as a special order.

* The 25A- series specifications and dimensions are the same as those of the standard model.

For details, refer to the [Web Catalog](#).

Replacement Parts for Single Unit / How to Order

Valve assembly

25A-ZK2 - VA **A** **K** **5** **L** A - A

① ② ③ ④

① Applicable system

A	Ejector system
----------	----------------

② Valve type

K	Supply valve: N.C., Release valve: N.C.
R	Supply valve: Self-holding release valve linked, Release valve: N.C.
J	Supply valve: N.C., Release valve: None

③ Rated voltage

5	24 VDC
6	12 VDC

④ Wiring

L	Individual wiring: With connector assembly (Lead wire length: 300 mm)
LO	Individual wiring: Without connector assembly

Select the 25A-ZK2VAAKLOA-A for a switch with energy saving function.

Connector assembly

ZK2 - LV **W** - A

Applicable valve type

W	Valve type K/R
S	Valve type J

Lead wire length

Nil	300 mm
6	600 mm
10	1000 mm
20	2000 mm
30	3000 mm

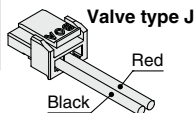
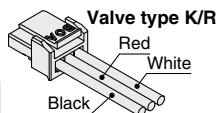

Sound absorbing material (10 pcs. per set)

ZK2 - SE1 - **1** - A

Sound absorbing material hole diameter

1	300 μm
----------	--------

Vacuum port adapter assembly (Purchasing order is available in units of 1 piece.)

ZK2 - VA1S **8** - A

One-touch fitting size

6	φ6 One-touch fitting	Metric size
8	φ8 One-touch fitting	

Filter element (10 pcs. per set)

ZK2 - FE1 - **3** - A

Nominal filtration rating

3	30 μm
----------	-------

Body gasket*¹ (10 pcs. per set)

ZK2 - BG5 - **1** - A

Applicable type

1	One check valve type (All specifications other than vacuum switch with energy saving function and exhaust interference prevention valve)
2	Two check valve type (Vacuum switch with energy saving function and exhaust interference prevention valve)

*1 When ZK2-BG5-2-A is mounted, the workpiece cannot be removed until vacuum is released.

Filter case*¹

ZK2 - FC - A

Port for the pressure switch or sensor

Symbol	Port for the pressure switch or sensor	Filter case color
P	With port (type with pressure switch or sensor)	Smoke
T	Without port (type without pressure switch or sensor)	Clear

*1 Vacuum port adapter assembly is not included.

Pressure switch for vacuum assembly (With 2 mounting screws)

25A-ZK2 - ZS **E** **A** **M** **G** - A

① ② ③ ④

① Rated pressure range and function

E	0 to -101 kPa	Pressure switch for vacuum	Open collector 2 outputs
F	-100 to 100 kPa	Pressure switch for vacuum with energy saving function	Open collector 1 output
V	-100 to 100 kPa	Pressure switch for vacuum with energy saving function	Open collector 1 output

② Output

A	NPN
B	PNP

③ Unit

Nil	Unit selection function* ¹
M	SI unit only* ²

*1 The unit selection function is not available in Japan due to the New Measurement Law.

*2 Fixed unit: kPa

④ Lead wire with connector

Nil	None	
G	With lead wire	When ① is E or F...For pressure switch for vacuum, Lead wire with connector (Length 2 m)
		When ① is V...For pressure switch for vacuum with energy saving function, Lead wire with connector (Length 2 m)

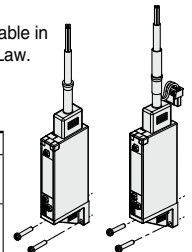

Lead wire with connector

(When individual lead wire is necessary, order with the part number below.)

Lead wire with connector for pressure switch for vacuum

ZS - 39 - 5G

Lead wire with connector for pressure switch for vacuum with energy saving function

ZK2 - LW **A** 20 - A

Output

A	NPN open collector
B	PNP open collector

Pressure sensor assembly (With 2 mounting screws)

25A-ZK2 - PS **1** - A

Rated pressure range

1	0 to -101 kPa, Output: 1 to 5 V, Accuracy: ± 2% F.S.
3	-100 to 100 kPa, Output: 1 to 5 V, Accuracy: ± 2% F.S.

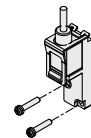

High-noise reduction silencer case assembly

ZK2 - SC3 - **4** - A

Applicable nozzle size

4	For nozzle size 07, 10
6	For nozzle size 12, 15

Sound absorbing material for high-noise reduction silencer (5 pcs. per set)

ZK2 - SE4 - 6 - A

Release lever (10 pcs. per set)

ZK2 - RL1 - A

Lock nut (10 pcs. per set)

25A-ZK2 - LN1 - A

25A-ZK2□A Series

Optional Specifications/Functions/Applications

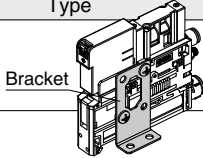
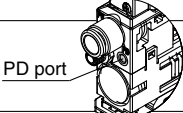
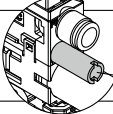
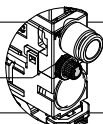
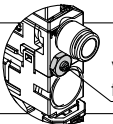
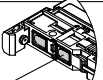
Symbol	Type	Function/Application
B	Mounting bracket for single unit (nuts and bolts are included)  Bracket	· Use when a single unit is mounted to the floor in an upright position is requested. If only ordering the bracket, the product number is as follows: 25A-ZK2-BK1-A (includes nuts and bolts).
D	With individual release pressure supply (PD) port (M3)  PD port	· Use when supply pressure for vacuum release is individually requested.
E	Screwdriver operation type long lock nut  Screwdriver operation type long lock nut	· Used when the needle adjustment operation is difficult
J	Vacuum break flow adjusting needle Round lock nut  Lock nut	· Thicker than standard hexagon type. More suitable for hand tightening. · Round lock nut improves operability when the port exhaust type is used.
K	Screwdriver operation type Vacuum break flow adjusting needle  Vacuum break flow adjusting needle	· Slotted type improves fine adjustment performance when the port exhaust type is used.
W	With exhaust interference prevention valve  Exhaust interference prevention valve	· When ejectors are operated individually, exhausted air may flow backward from the V port of ejectors that are turned off. Exhaust interference prevention valve prevents backflow.

Ejector System Compact Vacuum Unit With Energy Saving Function

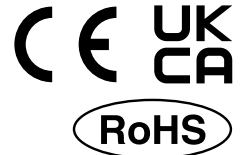

25A-ZQ□A Series

Single Unit Part Number

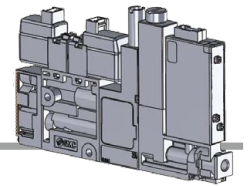

How to Order

25A-ZQ **05** **1U** A-K**15** LO □ - **VA** **M** **W** - **00** - □

Series compatible with secondary batteries

1 Nominal nozzle size

05	0.5
07	0.7
10	1.0

2 Body type

1U	For Single unit
3M	For Manifold

3 Solenoid valve combination

K1	Supply valve (N.C.), Release valve (N.C.)
-----------	---

4 Solenoid valve rated voltage

5	24 VDC
----------	--------

5 Electrical entry

LO	L plug connector (Without connector) With light/surge voltage suppressor
-----------	---

6 Manual override

Nil	Non-locking push type
B	Locking slotted type

7 Vacuum pressure switch (With suction filter*1)

Symbol	Pressure range [kPa]	Output
VA	-100 to 100	NPN 1 output + Energy saving function
VB		PNP 1 output + Energy saving function

*1 The filter used in this product is of a simple type, and will become clogged quickly in environments with high quantities of dust or particulates. Please consider using in combination with an air suction filter of the ZFC series, etc.

8 Unit

Nil *2	With unit switching function
M	SI unit only (kPa)

*2 Under the New Measurement Act, switches with the unit switching function are not permitted for use in Japan (implemented October 1999).

9 Lead wire

Nil	Without lead wire with connector
W	Lead wire for switch with energy saving function (Length: 2 m) (Included)

10 Fitting (V port)

Symbol	Applicable tubing O.D.
0	Without fitting (M5 x 0.8)

11 Fitting (P port)

Symbol	Applicable tubing O.D.	Specification
Nil	Without port	Manifold
0	Without fitting (M5 x 0.8)	Single unit

12 Option

	Bracket for single unit	
	Single unit	Manifold
Nil	With	Without
N	Without	Not available

* The 25A- series specifications and dimensions are the same as those of the standard model.

For details, refer to the [Web Catalog](#).

Ejector System Compact Vacuum Unit Without Energy Saving Function

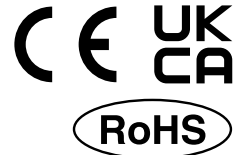

25A-ZQ□A Series

Single Unit Part Number

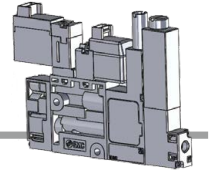

How to Order

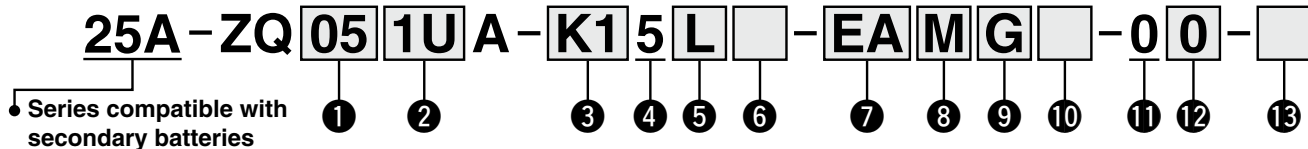

Series compatible with secondary batteries

① Nominal nozzle size

05	0.5
07	0.7
10	1.0

② Body type

1U	For Single unit
3M	For Manifold

③ Solenoid valve combination

K1	Supply valve (N.C.), Release valve (N.C.)
K2	Supply valve (N.O.), Release valve (N.C.)
J1	Supply valve (N.C.)
J2	Supply valve (N.O.)
Q1*1	Supply valve (Latching), Release valve (N.C.)
Q2*1	Supply valve (Latching)

*1 Latching (+ common)

④ Solenoid valve rated voltage

5	24 VDC
---	--------

⑤ Electrical entry

L	L plug connector (Lead wire length: 0.3 m) With light/surge voltage suppressor
LO	L plug connector (Without connector) With light/surge voltage suppressor

⑥ Manual override

Nil	Non-locking push type
	Latching: Push-locking slotted type
B*2	Locking slotted type

*2 When "Q1" is selected in ③, the locking slotted type is only available in the release valve.
This option cannot be chosen when "Q2" is selected in ③.

⑦ Vacuum pressure switch (With suction filter*3)

Symbol	Pressure range [kPa]	Output
EA	0 to -100	NPN 2 outputs
EB		PNP 2 outputs
EC		NPN 1 output + Analog voltage
EE		PNP 1 output + Analog voltage
FA	-100 to 100	NPN 2 outputs
FB		PNP 2 outputs
FC		NPN 1 output + Analog voltage
FE		PNP 1 output + Analog voltage
F*4	Suction filter only	

*3 The filter used in this product is of a simple type, and will become clogged quickly in environments with high quantities of dust or particulates. Please consider using in combination with an air suction filter of the ZFC series, etc.

*4 It is not necessary to select the items for ⑧ and ⑨.

⑧ Unit

Nil*5	With unit switching function
M	SI unit only (kPa)
P*5	With unit switching function (Initial value: psi)

*5 Under the New Measurement Act, switches with the unit switching function are not permitted for use in Japan (implemented October 1999).

⑨ Lead wire

Nil	Without lead wire with connector
G	Lead wire with connector (Length: 2 m) (Included)

⑩ Check valve*6

Nil	None
K*7	With check valve

*6 The check valve has a function to prevent the exhaust air from the exhaust unit overflowing to the vacuum port side when a manifold is used, but it cannot prevent overflow of the exhaust air completely. During usage, please inspect thoroughly with actual machine.

Also, in order to completely prevent the overflow of exhaust air, leave plenty of space between the check valve unit and adjacent ejector to avoid interference from the ejector's exhaust unit.

*7 Cannot be selected when ② is "1U"

In addition, for the type with a check valve, the air in the adsorption part is not released to the atmosphere when vacuum is stopped. If "J1," "J2," or "Q2" is selected for ③, be sure to also install a circuit for vacuum release.

⚠ Warning

- Cannot be used for vacuum retention
- Use a release valve. Without a release valve, a workpiece may not be released.

⑪ Fitting (V port)

Symbol	Applicable tubing O.D.
0	Without fitting (M5 x 0.8)

⑫ Fitting (P port)

Symbol	Applicable tubing O.D.	Specification
Nil	Without port	Manifold
0	Without fitting (M5 x 0.8)	Single unit

⑬ Option

For Single Unit (②: 1U)

Symbol	Bracket assembly	Converter assembly for solenoid valve*8
Nil	○	—
N	—	—
C	—	○
D	○	○

For Manifold (②: 3M)

Symbol	Low release pressure specification*9	Converter assembly for solenoid valve*8
Nil	—	—
S	○	—
C	—	○
E	○	○

*8 A converter assembly for attaching the VQ100 lead wire assembly with a connector to the ZQ-A is included. Refer to the "Converter assembly for solenoid valve" in the [Web Catalog](#).
"Q2" cannot be selected in ③. Select "LO" in ⑤.

*9 Select "C" for ④ for the manifold part number on page 180-3. "J1," "J2," or "Q2" cannot be selected in ③. For a release pressure supply pressure of 0.3 MPa or lower, select "S" or "E."

* The 25A- series specifications and dimensions are the same as those of the standard model.

For details, refer to the [Web Catalog](#).

25A-ZQ□A Series

Manifold Part Number

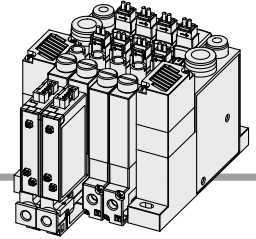

How to Order

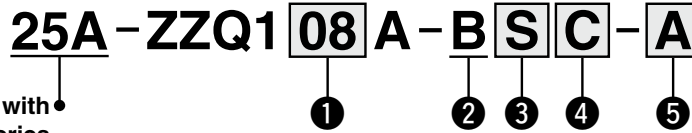

Series compatible with secondary batteries

1 Stations*1

01	1 station
02	2 stations
⋮	⋮
08	8 stations

*1 Number of stations varies according to nominal nozzle size during simultaneous operation. (Table 1)

Table 1. Max. Number of Stations that Can Operate Simultaneously*2

Nominal nozzle size	Max. number of stations that can operate simultaneously
0.5	8 stations
0.7	6 stations
1.0	4 stations

*2 For any of the nominal nozzle sizes, the max. number of stations that can be mounted is 8. However, please ensure that the max. number of stations that are operated simultaneously comply with the values above.

2 Air pressure supply (P) port location

B	Both sides
---	------------

4 Release pressure supply (PD) port

B	None (Release pressure: Commonly supplied from the P port)
C*3	Provided (Release pressure: Supplied from the PD port)

*3 For a release pressure supply pressure of 0.3 MPa or lower (for an individual unit without the energy-saving function), select "S" or "E" for **B** for the single unit part number on page 198.

3 Exhaust

S	Silencer exhaust (Both sides)
P	Port exhaust (Both sides)

5 Shipping configuration

Nil	Assembled as a vacuum unit
A*4	Manifold unit only

*4 A set of end blocks and the clamp rod assembly is included in this manifold unit. (Used for the maintenance of the end block)

* The 25A- series specifications and dimensions are the same as those of the standard model.

For details, refer to the [Web Catalog](#).

Manifold Order Example

25A-ZZQ104A-BSB..... 1 pc.

* 25A-ZQ053MA-K15L-EAG-0... 2 pcs. → Stations 1 and 2

* 25A-ZQ103MA-K15L-F-0 2 pcs. → Stations 3 and 4

* When the manifold is viewed from the vacuum (V) port, the first station starts from the left.

25A-ZQ053MA-K15L-EAG-0 (2 pcs.) and 25A-ZQ103MA-K15L-F-0 (2 pcs.) are arranged from the first station.

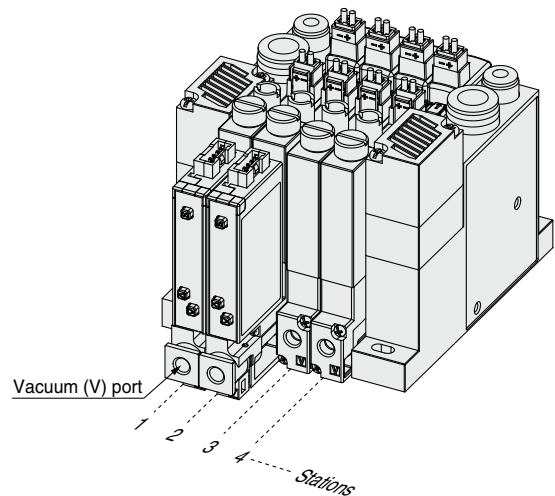

⚠ Caution when ordering manifold

- ! The asterisk (*) denotes the symbol for the assembly.
- ! Prefix it to the single unit part number.
- ! If "*" is not entered, the manifold and single unit will be shipped without being assembled.
- ! When the manifold and the units are not assembled, please assemble them by referring to "How to increase/decrease manifold stations" in the [Web Catalog](#).
- ! There is nothing else to arrange additionally.

25A-ZQ□A Series

Single Unit Part Number

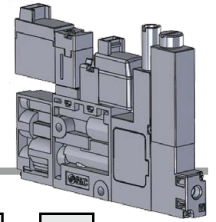

How to Order

25A-ZQ000 **U** A - **K1** **5** **L** □ - **E** **A** **M** **G** - **0** **0** - □

Series compatible with secondary batteries

1 Body type

U	For Single unit
M	For Manifold

2 Solenoid valve combination

K1	Supply valve (N.C.), Release valve (N.C.)
K2	Supply valve (N.O.), Release valve (N.C.)
J1 *1	Supply valve (N.C.)
J2 *1	Supply valve (N.O.)
Q1 *2	Supply valve (Latching), Release valve (N.C.)
Q2 *1 *2	Supply valve (Latching)

*1 The air in the adsorption section of this product is not released to the atmosphere at the vacuum suspension state. Devise the circuit for the vacuum release additionally.

*2 Latching (+ common)

3 Solenoid valve rated voltage

5	24 VDC
----------	--------

4 Electrical entry

L	L plug connector (Lead wire length: 0.3 m) With light/surge voltage suppressor
LO	L plug connector (Without connector) With light/surge voltage suppressor

5 Manual override

Nil	Non-locking push type
	Latching: Push-locking slotted type
B *3	Locking slotted type

*3 When "Q1" is selected in 2, the locking slotted type is only available in the release valve. This option cannot be chosen when "Q2" is selected in 2.

6 Vacuum pressure switch (With suction filter*4)

Symbol	Pressure range [kPa]	Output
EA	0 to -100	NPN 2 outputs
EB		PNP 2 outputs
EC		NPN 1 output + Analog voltage
EE		PNP 1 output + Analog voltage
FA		NPN 2 outputs
FB	-100 to 100	PNP 2 outputs
FC		NPN 1 output + Analog voltage
FE		PNP 1 output + Analog voltage
F *5	Suction filter only	

*4 The filter used in this product is of a simple type, and will become clogged quickly in environments with high quantities of dust or particulates. Please consider using in combination with an air suction filter of the ZFC series, etc.

*5 It is not necessary to select the items for 7 and 8.

7 Unit

Nil *6	With unit switching function
M	SI unit only (kPa)
P *6	With unit switching function (Initial value: psi)

*6 Under the New Measurement Act, switches with the unit switching function are not permitted for use in Japan (implemented October 1999).

8 Lead wire

Nil	Without lead wire with connector
G	Lead wire with connector (Length: 2 m) (Included)

9 Fitting (V port)

Symbol	Applicable tubing O.D.
0	Without fitting (M5 x 0.8)

10 Fitting (PS/PV port)

Symbol	Applicable tubing O.D.	Specification
Nil	Without port	Manifold
0	Without fitting (M5 x 0.8)	Single unit

11 Option

For Single Unit (1: U)

Symbol	Bracket assembly	Converter assembly for solenoid valve*7
Nil	○	—
N	—	—
C	—	○
D	○	○

For Manifold (1: M)

Symbol	Low release pressure specification*8	Converter assembly for solenoid valve*7
Nil	—	—
S	○	—
C	—	○
E	○	○

*7 A converter assembly for attaching the VQ100 lead wire assembly with a connector to the ZQ-A is included. Refer to the "Converter Assembly for Solenoid Valve" in the **Web Catalog**. "Q2" cannot be selected in 2. Select "LO" in 4.

*8 Select "C" for 3 for the manifold part number on page 201. "J1", "J2", or "Q2" cannot be selected in 2. For a release pressure supply pressure of 0.3 MPa or lower, select "S" or "E."

* The 25A- series specifications and dimensions are the same as those of the standard model.

For details, refer to the **Web Catalog**.

25A-ZQ□A Series

Manifold Part Number

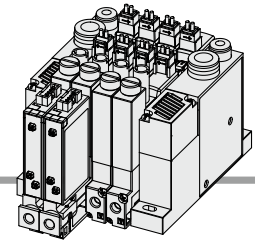

How to Order

25A-ZZQ1 08 A-L O C-A

Series compatible with secondary batteries

① ② ③ ④

① Stations

01	1 station
02	2 stations
⋮	⋮
08	8 stations

② Vacuum pressure supply (PV) port location*1

L	Left side
R	Right side

*1 The position of the vacuum pressure supply (PV) port when the vacuum (V) port is facing front. The pilot pressure supply (PS) port is on the opposite side. Refer to the "Table 1" for details.

③ Release pressure supply (PD) port

B	None (Release pressure: Commonly supplied from the PS port)
C*2	Provided (Release pressure: Supplied from the PD port)

*2 For a release pressure supply pressure of 0.3 MPa or lower, select "S" or "E" for ① for the single unit part number on page 200.

④ Shipping configuration

Nil	Assembled as a vacuum unit
A*3	Manifold unit only

*3 A set of end blocks and the clamp rod assembly is included in this manifold unit. (Used for the maintenance of the end block)

Table 1. Location of Each Port

② PV port location	③ PD port	Left side with the V port facing the front			Right side with the V port facing the front		
		PS port	PV port	PD port	PS port	PV port	PD port
L	B	—	●	—	●	—	—
	C	—	●	●	●	—	●
R	B	●	—	—	—	●	—
	C	●	—	●	—	●	●

* The 25A- series specifications and dimensions are the same as those of the standard model.

For details, refer to the [Web Catalog](#).

Manifold Order Example

25A-ZZQ104A-ROB 1 pc.

* 25A-ZQ000MA-K15L-EAG-0... 2 pcs. → Stations 1 and 2

* 25A-ZQ000MA-K15L-F-0 2 pcs. → Stations 3 and 4

* When the manifold is viewed from the vacuum (V) port, the first station starts from the left.

25A-ZQ000MA-K15L-EAG-0 (2 pcs.) and 25A-ZQ000MA-K15L-F-0 (2 pcs.) are arranged from the first station.

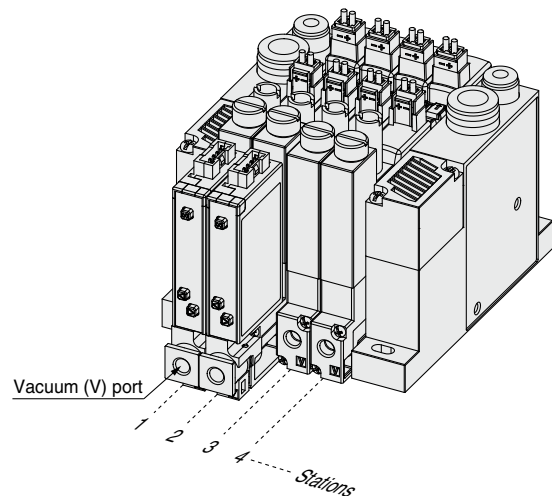

⚠ Caution when ordering manifold

- ! The asterisk (*) denotes the symbol for the assembly.
- ! Prefix it to the single unit part number.
- ! If "*" is not entered, the manifold and single unit will be shipped without being assembled.
- ! When the manifold and the units are not assembled, please assemble them by referring to "How to increase/decrease manifold stations" in the [Web Catalog](#).
- ! There is nothing else to arrange additionally.

Construction

Vacuum ejector (N.O. specification)

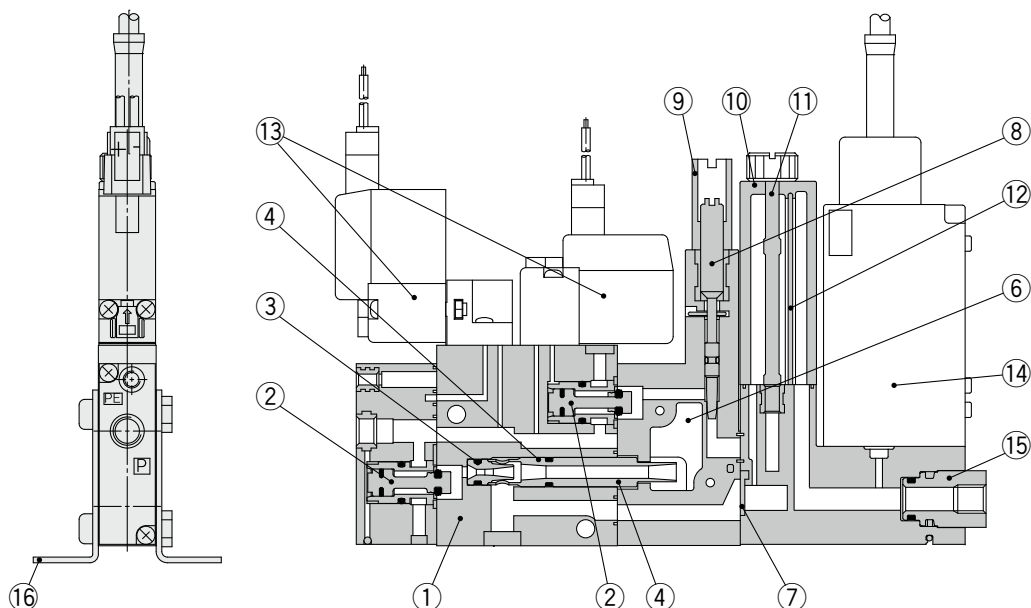

Vacuum pump system (N.C. specification)

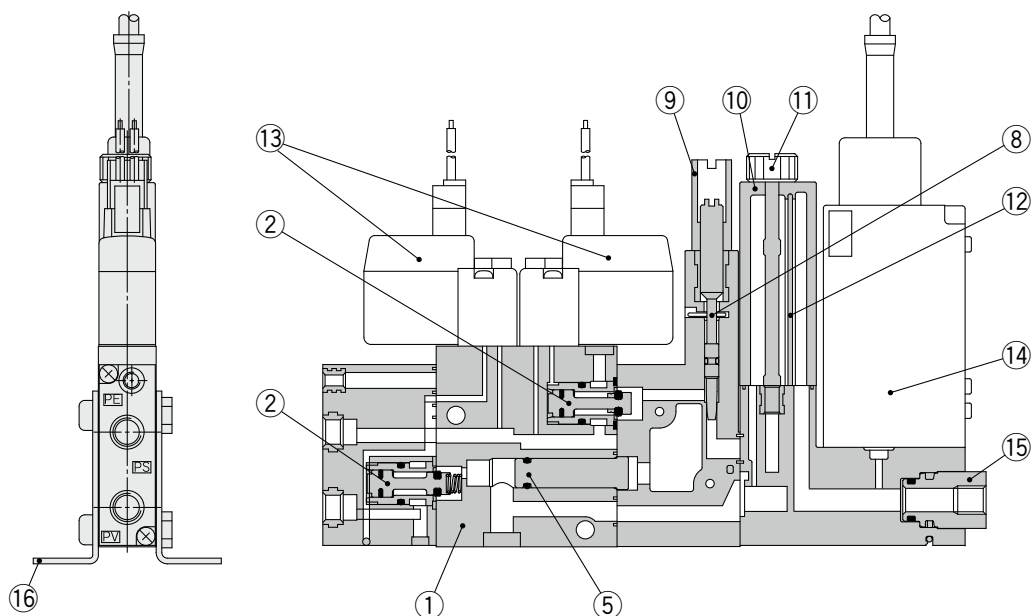

Component Parts

No.	Description	Material	Note
1	Body	PBT	Aluminum alloy is also used.
2	Supply valve / Release valve assembly	POM/Aluminum alloy/Stainless steel	
3	Nozzle	PBT	
4	Diffuser	PBT	
5	Bushing	Aluminum alloy	
6	Sound absorbing material	Non-woven fabric (PET)	Refer to [3] on page 204 for how to order. (When replacing the sound absorbing material, order a silencer plate assembly.) Refer to [6] on page 204 for how to order.
7	Check valve	HNBR	
8	Vacuum release flow adjusting needle	Stainless steel	
9	Lock nut	Aluminum alloy (Anodized)	
10	Filter case	PC (Refer to the precautions in the Web Catalog .)	Refer to [4] on page 204 for how to order.
11	Tension bolt	Stainless steel	
12	Filter element	PVA sponge	Refer to [5] on page 204 for how to order.
13	Pilot supply valve / Pilot valve (for release)	—	Refer to [1] on page 203 for how to order.
14	Vacuum pressure switch	—	Refer to [2] on page 203 for how to order.
15	Vacuum (V) port M5 bushing	Aluminum alloy (Anodized)	
16	Bracket assembly	Steel (Electroless nickel plating), Stainless steel	Refer to [7] on page 204 for how to order.
—	Seal material (O-ring, etc.)	NBR/HNBR	
—	Screws for assembly	Steel (Electroless nickel plating), Stainless steel	

25A-ZQ□A Series

How to Order Replacement Parts for Single Unit

1 Solenoid Valve

(Recommended torque for replacement: 0.054 to 0.08 N-m)

N.C. Pilot Supply Valves,
Pilot Valves (for Release)

25A - ZQ1 - V114 - 5 **L** **U** □ - A

① ②

1 Electrical entry

L	LO
With lead wire (300 mm)	Without connector

2 Manual override

Nil	B
Non-locking push type	Locking slotted type

N.O. Pilot Supply Valves

25A - ZQ1 - V124 - 5 **M** **U** □ - A

① ②

1 Electrical entry

M	MO
With lead wire (300 mm)	Without connector

2 Manual override

Nil	B
Non-locking push type	Locking slotted type

Latching Pilot Supply Valves

25A - ZQ1 - VQ110L - 5 **L** - A

①

1 Electrical entry

L	LO
With lead wire (300 mm)	Without connector

Lead Wire with Connector Assembly for Solenoid Valve

For N.C./N.O. Pilot Valves,
Pilot Valves (for Release)

SY100 - 30 - 4 A - **6** ① Lead wire length

For Latching Pilot Valves

AXT661 - 13A - **6**

Nil	300 mm
6	600 mm
10	1000 mm
15	1500 mm
20	2000 mm
30	3000 mm
50	5000 mm

Connector and Socket for Solenoid Valve

For N.C./N.O. Pilot Valves,
Pilot Valves (for Release)

SY100 - 30 - A * With connector and sockets only
(Number of sockets: 2)

For Latching Pilot Valves

AXT661 - 12A
(Number of sockets: 3)

2 Vacuum Pressure Switch (With Suction Filter)

(Recommended torque for replacement: 0.11 to 0.13 N-m)

25A - ZQ - ZS **EA** **M** **G** □ - 0 - A

① ② ③ ④ ⑤

1 Vacuum pressure switch

Symbol	Pressure range [kPa]	Output
EA	0 to -100	NPN 2 outputs
EB		PNP 2 outputs
EC		NPN 1 output + Analog voltage
EE		PNP 1 output + Analog voltage
FA	-100 to 100	NPN 2 outputs
FB		PNP 2 outputs
FC		NPN 1 output + Analog voltage
FE		PNP 1 output + Analog voltage
VA *1		NPN 1 output + Energy saving control
VB *1		PNP 1 output + Energy saving control

*1 It is not possible to replace the vacuum pressure switch from the specification without energy saving function to the specification with energy saving function.

2 Unit

Nil *2	With unit switching function
M	SI unit only (kPa)
P *2, *3	With unit switching function (Initial value: psi)

*2 Under the New Measurement Act, switches with the unit switching function are not permitted for use in Japan (implemented October 1999).

*3 Cannot be selected when ① is "VA" or "VB"

3 Lead wire

Nil	Without lead wire with connector
G	Lead wire with connector (Length: 2 m) (Included)
W	Lead wire for switch with energy saving function (Length: 2 m) (Included)

4 Check valve*4

Nil	None
K *5	With check valve

*4 The check valve has a function to prevent the exhaust air from the exhaust unit overflowing to the vacuum port side when a manifold is used, but it cannot prevent overflow of the exhaust air completely. During usage, please inspect thoroughly with actual machine.

Also, in order to completely prevent the overflow of exhaust air, leave plenty of space between the check valve unit and adjacent ejector to avoid interference from the ejector's exhaust unit.

*5 When "VA" or "VB" is specified for ①, the check valve is already built in.

⚠ Warning

- Cannot be used for vacuum retention
- Use a release valve. Without a release valve, a workpiece may not be released.

5 Fitting (V port)

Symbol	Applicable tubing O.D.
0	Without fitting (M5 x 0.8)

Lead Wire with Connector Assembly for Vacuum Pressure Switch

(When an individual lead wire is necessary, order with the part numbers below.)

· Lead wire with connector for vacuum pressure switch

ZS - 39 - 5G

· Lead wire with connector for pressure switch with energy saving function

ZQ1 - LW6 - **N - A**

① Output

N	NPN open collector
P	PNP open collector

How to Order Replacement Parts for Single Unit

3 Silencer Plate Assembly

25A – ZQ1 – PL11 – A

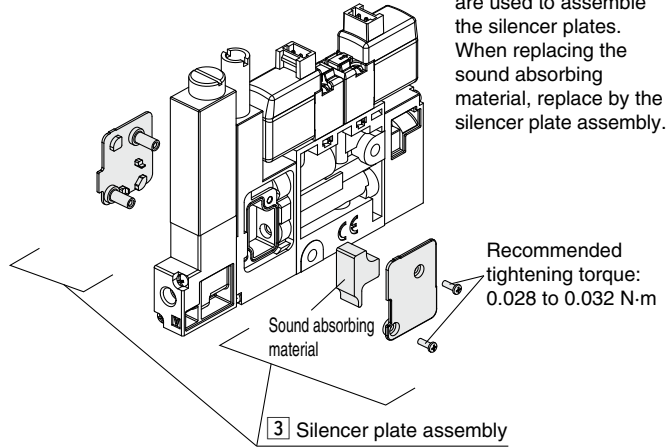

4 Filter Case Assembly * One filter element is included.

ZQ1 – FC1 – A

5 Filter Element (10 pcs. per set)

ZQ1 – FE2 – A

6 Check Valve

ZQ1 – CV

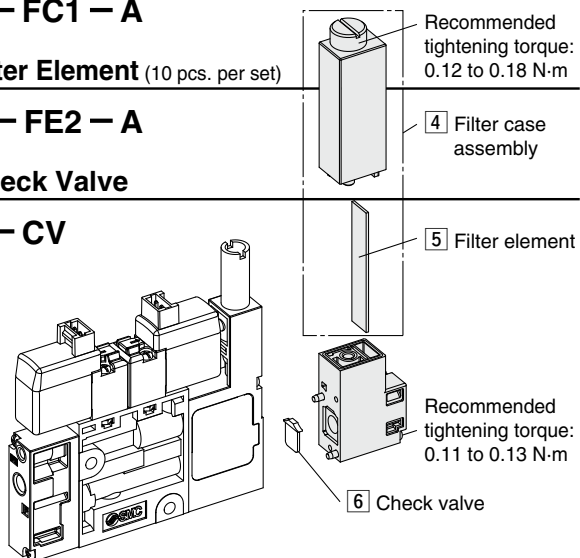

7 Bracket Assembly

25A – ZQ1 – BK1 – A

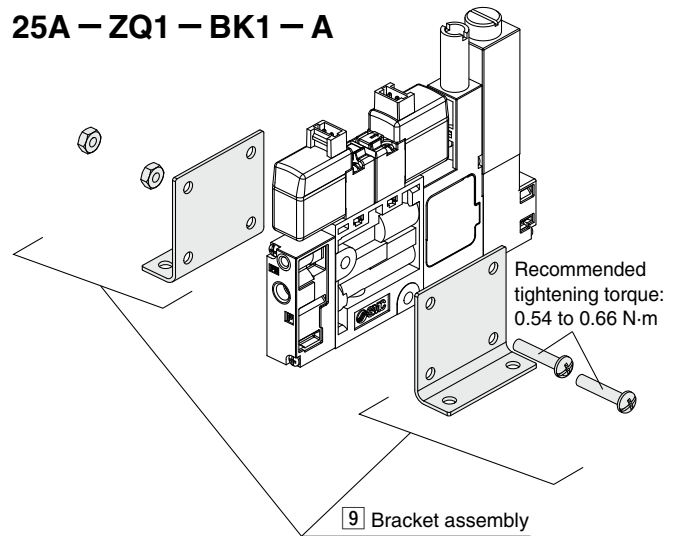

Compact Vacuum Unit/25A-ZQ□A Series Manifold Exploded View

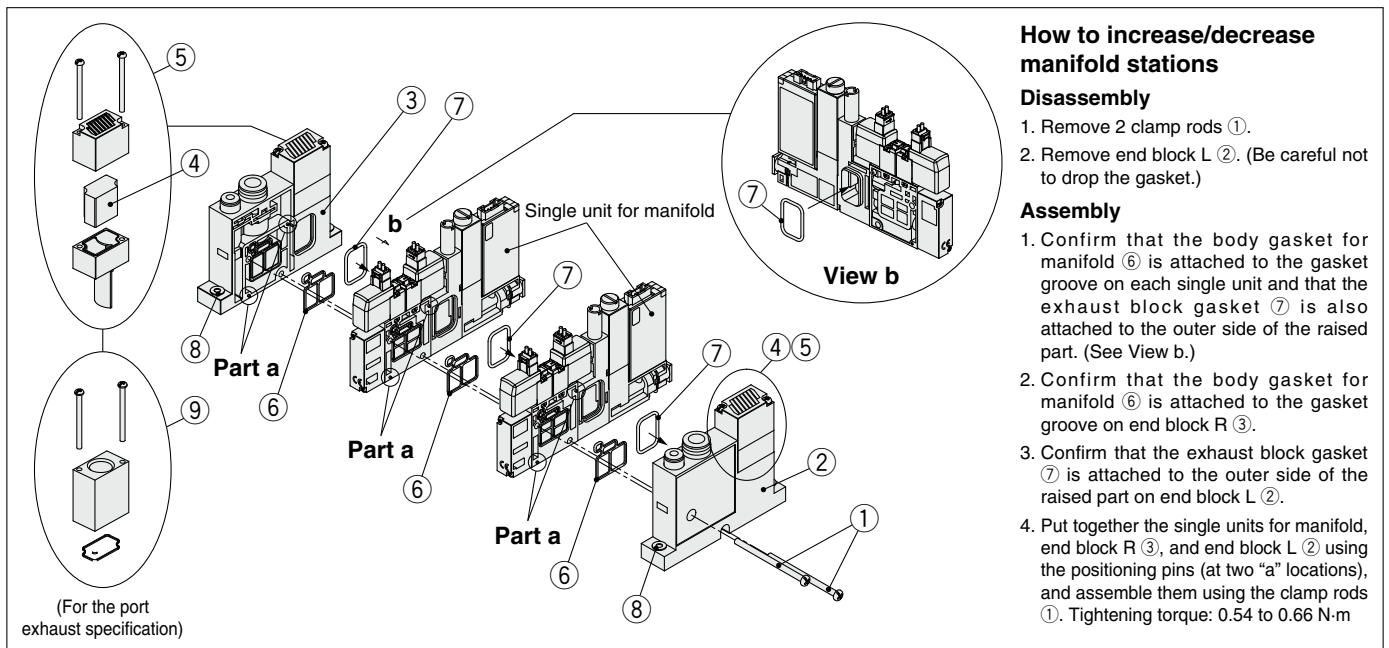

How to increase/decrease manifold stations

Disassembly

1. Remove 2 clamp rods ①.
2. Remove end block L ②. (Be careful not to drop the gasket.)

Assembly

1. Confirm that the body gasket for manifold ⑥ is attached to the gasket groove on each single unit and that the exhaust block gasket ⑦ is also attached to the outer side of the raised part. (See View b.)
2. Confirm that the body gasket for manifold ⑥ is attached to the gasket groove on end block R ③.
3. Confirm that the exhaust block gasket ⑦ is attached to the outer side of the raised part on end block L ②.
4. Put together the single units for manifold, end block R ③, and end block L ② using the positioning pins (at two "a" locations), and assemble them using the clamp rods ①. Tightening torque: 0.54 to 0.66 N·m

Component Parts

No.	Description	Material	Note
1	Clamp rod assembly	Steel (Electroless nickel plating)	Refer to ① below for how to order.
2	End block L	PBT, POM, PET, Steel, Aluminum alloy, Stainless steel	Left side with the vacuum (V) port facing the front
3	End block R	PBT, POM, PET, Steel, Aluminum alloy, Stainless steel	Right side with the vacuum (V) port facing the front
4	Sound absorbing material (For Manifold)	Non-woven fabric (PET)	Refer to ② below for how to order.
5	Silencer block assembly	PBT	Refer to ③ below for how to order.
6	Body gasket for manifold	NBR	Refer to ④ below for how to order.
7	Exhaust block gasket	NBR	Refer to ⑤ below for how to order.
8	Washer assembly	Stainless steel	Refer to ⑥ below for how to order.
9	Port block assembly	Aluminum alloy, Steel (Electroless nickel plating), NBR	Refer to ⑦ below for how to order.

How to Order Replacement Parts for Manifold

① Clamp Rod Assembly (2 pcs. per set)

25A - ZQ1 - SR1 - 04 - A ① Stations

01	For 1 station
02	For 2 stations
⋮	⋮
08	For 8 stations

② Sound Absorbing Material (For Manifold)

(2 pcs. per set)

ZQ1 - SE2 - A

Recommended tightening torque: 0.25 to 0.31 N·m

③ Silencer Block Assembly

(2 pcs. per set)

25A - ZQ1 - SC1 - A

② Sound absorbing material (For Manifold)

③ Silencer block assembly

④ Body Gasket for Manifold (10 pcs. per set)

ZQ - 3 - 005 - 10AS

⑤ Exhaust Block Gasket (10 pcs. per set)

ZQ - 3 - 009 - 10AS

⑥ Washer Assembly (4 pcs. per set)

25A - ZQ1 - WS ③ - A

① Size

3	For M3 (Without release pressure supply port)
4	For M4 (With release pressure supply port)

⑦ Port Block Assembly

(2 pcs. per set)

25A - ZQ1 - EP2 - A

Recommended tightening torque: 0.25 to 0.31 N·m

This product (only the One-touch fitting port type) is a secondary battery compatible product. For details, refer to the [Web Catalog](#).

Vacuum Ejector Body Ported Type/Box Type (Built-in Silencer)

ZH Series

RoHS

Compact and lightweight

Body ported type

Port size: G threads have been added.



Overall length Max. **12%** reduction
(6.7 mm shorter)

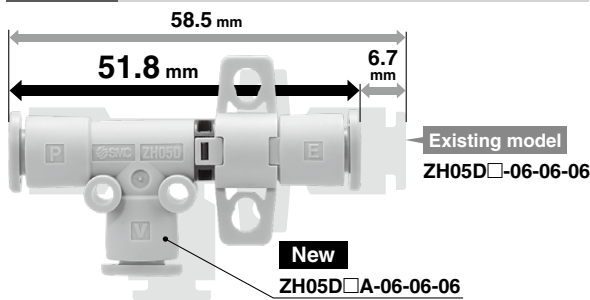

Port height Max. **26%** reduction
(9.1 mm shorter)

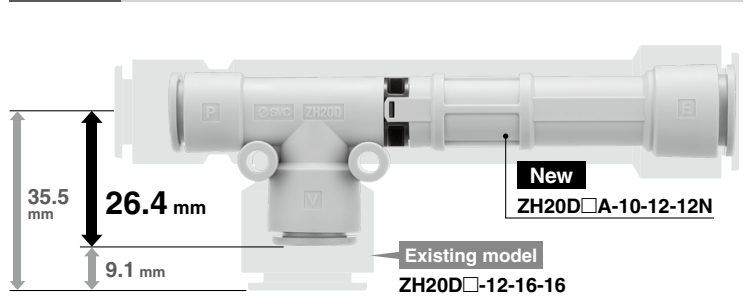

Weight Max. **74%** reduction Existing model 88.4 g ▶ New 23.3 g
(65.1 g lighter)

Box type (Built-in silencer)



Volume Max. **39%** reduction Existing model ZH10B□-06-06
(14.1 cm³ reduction)

Existing model 36.3 cm³ ▶ New 22.2 cm³

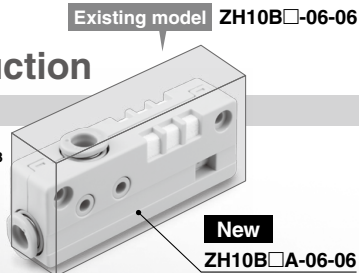

Weight Max. **59%** reduction
(19.4 g lighter)

Existing model 33 g ▶ New 13.6 g

Port height Max. **20%** reduction
(4.6 mm shorter)

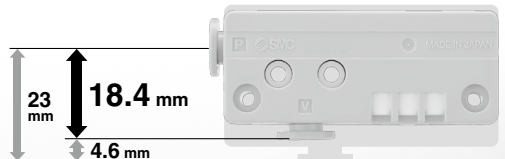

Nozzle sizes
ø1.5, ø1.8, and ø2.0
have been added to
the box type.

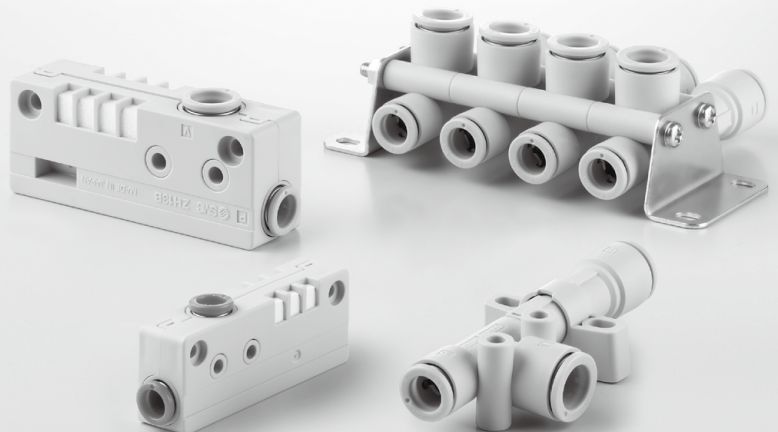
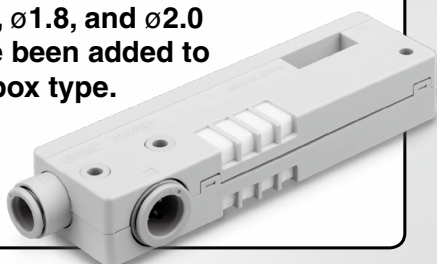

This product (only the One-touch fitting port type) is a secondary battery compatible product. For details, refer to the [Web Catalog](#).

In-line Type Vacuum Ejector

ZU□A Series

RoHS

Compact and Lightweight

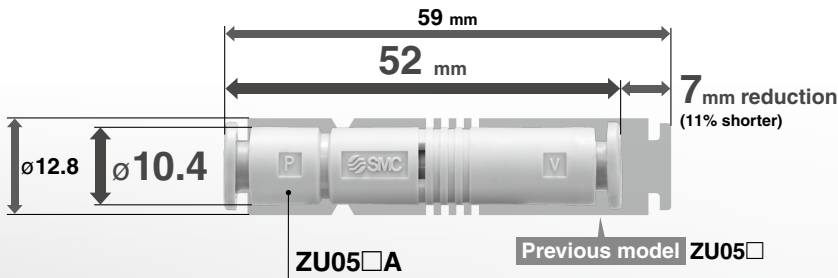

- O.D.** $\varnothing 10.4$ (Previous model $\varnothing 12.8$)
- Weight** **3.9 g** (Previous model 6.5 g)
- Overall length** **52 mm** (Previous model 59 mm)



Application Examples

For preventing pad adsorption failures from the vacuum source

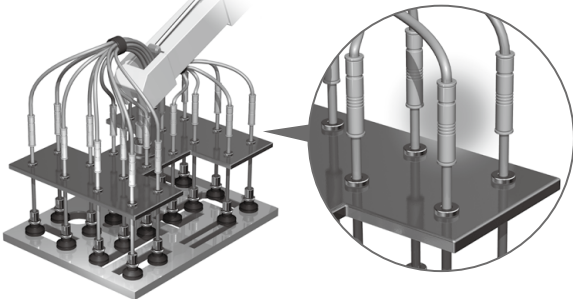

Numerous pads can be used to adsorb workpieces with holes.

For improving responsiveness by installing on flexible parts

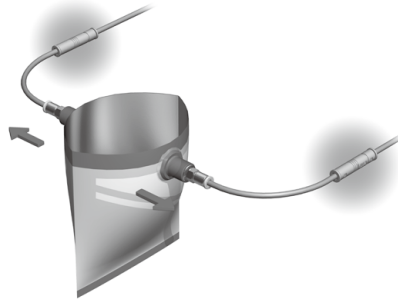

Can be used to open and close plastic bags



For mounting on the end of a Z-axis air cylinder

Variations

Model	Nozzle size [mm]	Standard supply pressure [MPa]	Ultimate vacuum pressure [kPa]		Maximum suction flow rate [L/min (ANR)]		Air consumption [L/min (ANR)]	Port size
			Type S	Type L	Type S	Type L		
ZU03□A	0.3	0.35	-85	-40	1.8	3.4	4.2	$\varnothing 4$ One-touch fitting $\varnothing 5/32$ "
ZU04□A	0.4		-87		3.2	5.8		
ZU05□A	0.5	0.45	-90	-48	7	13	14	
ZU07□A	0.7				11	16		28



Basic Pad

Flat Type

ZP Series

For pad units and pads with an adapter (stainless steel type): The standard product is a secondary battery compatible product. For details on specifications and dimensions, refer to the [Web Catalog](#).



How to Order

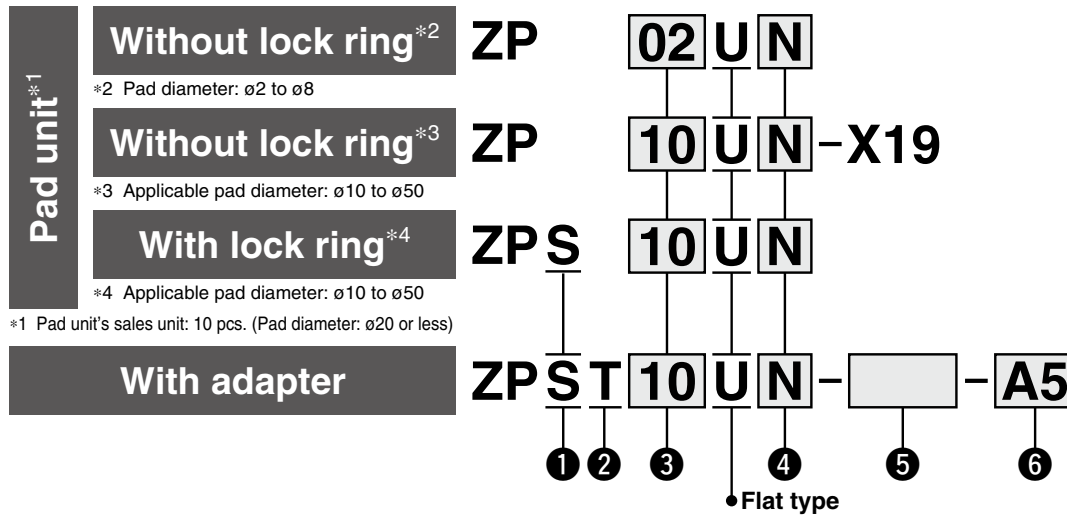

① Adapter (Lock ring) material

S	Stainless steel (Stainless steel 304)
----------	---------------------------------------

② Vacuum inlet direction

T	Vertical
----------	----------

③ Pad diameter

02	$\phi 2$	16	$\phi 16$
04	$\phi 4$	20	$\phi 20$
06	$\phi 6$	25	$\phi 25$
08	$\phi 8$	32	$\phi 32$
10	$\phi 10$	40	$\phi 40$
13	$\phi 13$	50	$\phi 50$

④ Material

N	NBR
S	Silicone rubber*1 *2
U	Urethane rubber
F	FKM
GN	Conductive NBR
GS	Conductive silicone rubber

*1 Compliant with the FDA (USA Food and Drug Administration) regulation 21CFR§177.2600 for "Rubber articles intended for repeated use"

*2 Compliant with the standards for "Rubber apparatus (excluding baby drinking apparatus) and containers/packaging" (D3) (Partial revision: Ministry of Health, Labour, and Welfare Notification No. 595, 2012) in Section 3 "Apparatus and Containers/Packaging" of the Food Sanitation Act, Article 18 "Specifications and Standards for Food and Food Additives, etc." (Ministry of Health and Welfare Notification No. 370, 1959)

With adapter

⑤ Vacuum inlet

Type	Symbol	Size	Pad diameter [mm]				
			$\phi 2$ to $\phi 8$	$\phi 10$ to $\phi 16$	$\phi 20$ to $\phi 32$	$\phi 40, \phi 50$	
Male thread	A5	M5 x 0.8	○*1	—	—	—	
	AS5		—	○*1	○*1	—	
	A6	M6 x 1	○*1	—	—	—	
	AS6		—	○*1	○*1	○*1	
	AG01		G1/8	—	○*1	○*1	—
	AG02		G1/4	—	—	—	○*1
Female thread	Nil	M3 x 0.5	—	○ (⑥ Connection thread: A5/A6)	○ (⑥ Connection thread: A6)	○ (⑥ Connection thread: A6)	
		M5 x 0.8	—	—	○ (⑥ Connection thread: A8)	○ (⑥ Connection thread: A8)	
	B4	M4 x 0.7	○*1	—	—	—	
	B5	M5 x 0.8	○*1	○*1	○*1	—	
	B6	M6 x 1	—	○*1	○*1	○*1	
	B8	M8 x 1.25	—	—	○*1	○*1	
	B01	Rc1/8	—	○*1	○*1	○*1	
	BG01	G1/8	—	○*1	○*1	—	
	BG02	G1/4	—	—	—	○*1	

*1 Use the connection thread.

⑥ Connection thread

Type	Symbol	Size	Pad diameter [mm]			
			$\phi 2$ to $\phi 8$	$\phi 10$ to $\phi 16$	$\phi 20$ to $\phi 32$	$\phi 40, \phi 50$
Male thread	A5	M5 x 0.8	—	○*2	—	—
	A6	M6 x 1	—	○*2	○*2	○*2
	A8	M8 x 1	—	—	○*2	○*2

*2 With a (female) vacuum inlet

Lock ring unit

Part no.	Pad diameter [mm]
ZPSL1	$\phi 10$ to $\phi 16$
ZPSL2	$\phi 20$ to $\phi 32$
ZPSL3	$\phi 40, \phi 50$



Basic Pad

Flat Type with Ribs

ZP Series

For pad units and pads with an adapter (stainless steel type): The standard product is a secondary battery compatible product. For details on specifications and dimensions, refer to the [Web Catalog](#).



How to Order

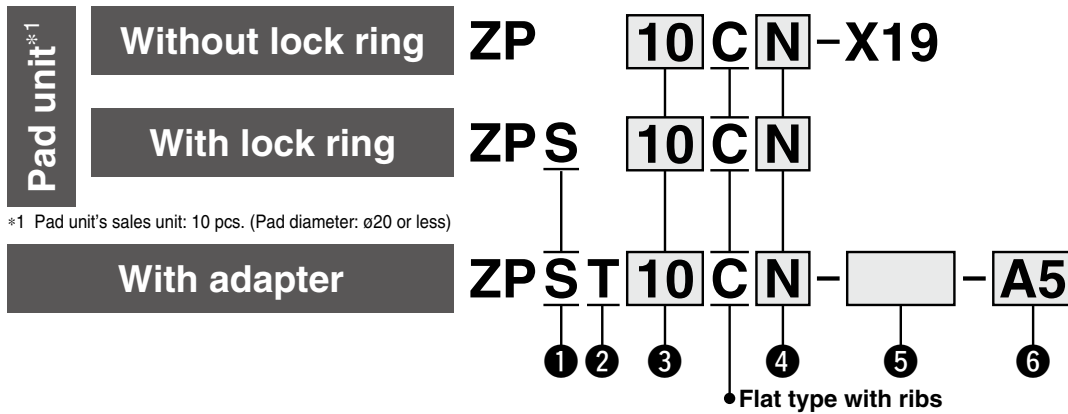

*1 Pad unit's sales unit: 10 pcs. (Pad diameter: ø20 or less)

① Adapter (Lock ring) material

S	Stainless steel (Stainless steel 304)
---	---------------------------------------

② Vacuum inlet direction

T	Vertical
---	----------

③ Pad diameter

10	ø10
13	ø13
16	ø16
20	ø20
25	ø25
32	ø32
40	ø40
50	ø50

④ Material

N	NBR
S	Silicone rubber*1 *2
U	Urethane rubber
F	FKM
GN	Conductive NBR
GS	Conductive silicone rubber

*1 Compliant with the FDA (USA Food and Drug Administration) regulation 21CFR§177.2600 for "Rubber articles intended for repeated use"

*2 Compliant with the standards for "Rubber apparatus (excluding baby drinking apparatus) and containers/packaging" (D3) (Partial revision: Ministry of Health, Labour, and Welfare Notification No. 595, 2012) in Section 3 "Apparatus and Containers/Packaging" of the Food Sanitation Act, Article 18 "Specifications and Standards for Food and Food Additives, etc." (Ministry of Health and Welfare Notification No. 370, 1959)

With adapter

⑤ Vacuum inlet

Type	Symbol	Size	Pad diameter [mm]		
			ø10 to ø16	ø20 to ø32	ø40, ø50
Male thread	AS5	M5 x 0.8	○*2	○*2	—
	AS6	M6 x 1	○*2	○*2	○*2
	AG01	G1/8	○*2	○*2	—
	AG02	G1/4	—	—	○*2
Female thread	Nil	M3 x 0.5	○ (⑥ Connection thread: A5/A6)	○ (⑥ Connection thread: A6)	○ (⑥ Connection thread: A6)
		M5 x 0.8	—	○ (⑥ Connection thread: A8)	○ (⑥ Connection thread: A8)
	B5	M5 x 0.8	○*2	○*2	—
	B6	M6 x 1	○*2	○*2	○*2
	B8	M8 x 1.25	—	○*2	○*2
	B01	Rc1/8	○*2	○*2	○*2
	BG01	G1/8	○*2	○*2	—
	BG02	G1/4	—	—	○*2

*1 Use the connection thread.

⑥ Connection thread

Type	Symbol	Size	Pad diameter [mm]		
			ø10 to ø16	ø20 to ø32	ø40, ø50
Male thread	A5	M5 x 0.8	○*2	—	—
	A6	M6 x 1	○*2	○*2	○*2
	A8	M8 x 1	—	○*2	○*2

*2 With a (female) vacuum inlet

Lock ring unit

Part no.	Pad diameter [mm]
ZPSL1	ø10 to ø16
ZPSL2	ø20 to ø32
ZPSL3	ø40, ø50



Basic Pad Bellows Type ZP Series

For pad units and pads with an adapter (stainless steel type): The standard product is a secondary battery compatible product. For details on specifications and dimensions, refer to the [Web Catalog](#).



How to Order

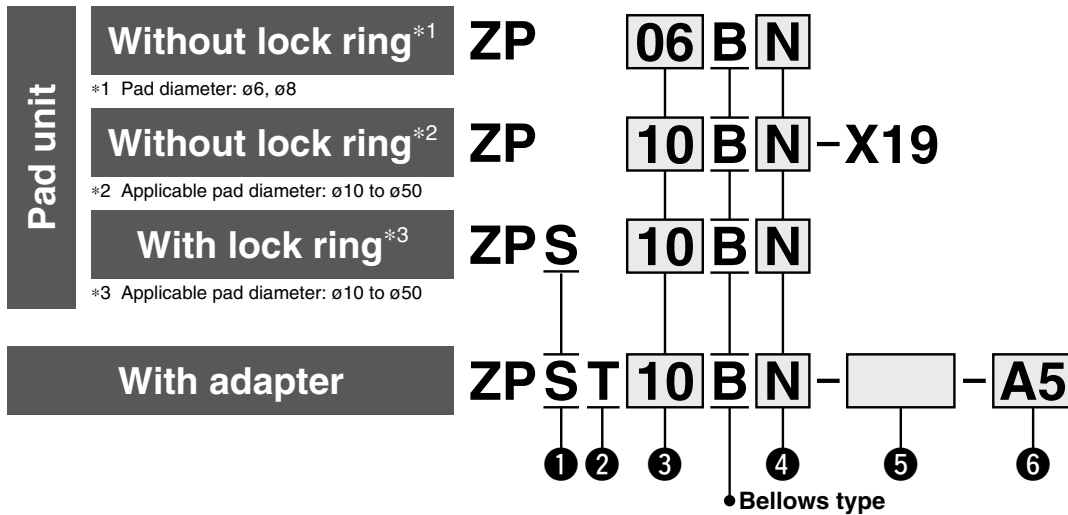

① Adapter (Lock ring) material

S	Stainless steel (Stainless steel 304)
----------	---------------------------------------

② Vacuum inlet direction

T	Vertical
----------	----------

③ Pad diameter

06	ø6	20	ø20
08	ø8	25	ø25
10	ø10	32	ø32
13	ø13	40	ø40
16	ø16	50	ø50

④ Material

N	NBR
S	Silicone rubber*1 *2
U	Urethane rubber
F	FKM
GN	Conductive NBR
GS	Conductive silicone rubber

*1 Compliant with the FDA (USA Food and Drug Administration) regulation 21CFR§177.2600 for "Rubber articles intended for repeated use"

*2 Compliant with the standards for "Rubber apparatus (excluding baby drinking apparatus) and containers/packaging" (D3) (Partial revision: Ministry of Health, Labour, and Welfare Notification No. 595, 2012) in Section 3 "Apparatus and Containers/Packaging" of the Food Sanitation Act, Article 18 "Specifications and Standards for Food and Food Additives, etc." (Ministry of Health and Welfare Notification No. 370, 1959)

With adapter

⑤ Vacuum inlet

Type	Symbol	Size	Pad diameter [mm]			
			ø6, ø8	ø10 to ø16	ø20 to ø32	ø40, ø50
Male thread	A5	M5 x 0.8	○*1	—	—	—
	AS5		—	○*1	○*1	—
	A6	M6 x 1	○*1	—	—	—
	AS6		—	○*1	○*1	○*1
	AG01		G1/8	—	○*1	○*1
AG02	G1/4	—	—	—	○*1	
Female thread	Nil	M3 x 0.5	—	○ (⑥ Connection thread: A5/A6)	○ (⑥ Connection thread: A6)	○ (⑥ Connection thread: A6)
		M5 x 0.8	—	—	○ (⑥ Connection thread: A8)	○ (⑥ Connection thread: A8)
	B4	M4 x 0.7	○*1	—	—	—
	B5	M5 x 0.8	○*1	○*1	○*1	—
	B6	M6 x 1	—	○*1	○*1	○*1
	B8	M8 x 1.25	—	—	○*1	○*1
	B01	Rc1/8	—	○*1	○*1	○*1
	BG01	G1/8	—	○*1	○*1	—
	BG02	G1/4	—	—	—	○*1

*1 Use the connection thread.

⑥ Connection thread

Type	Symbol	Size	Pad diameter [mm]			
			ø6, ø8	ø10 to ø16	ø20 to ø32	ø40, ø50
Male thread	A5	M5 x 0.8	—	○*2	—	—
	A6	M6 x 1	—	○*2	○*2	○*2
	A8	M8 x 1	—	—	○*2	○*2

*2 With a (female) vacuum inlet

Lock ring unit

Part no.	Pad diameter [mm]
ZPSL1	ø10 to ø16
ZPSL2	ø20 to ø32
ZPSL3	ø40, ø50

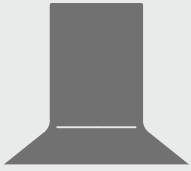

Basic Pad

Thin Flat Type

ZP Series

For pad units and pads with an adapter (stainless steel type): The standard product is a secondary battery compatible product. For details on specifications and dimensions, refer to the [Web Catalog](#).



How to Order

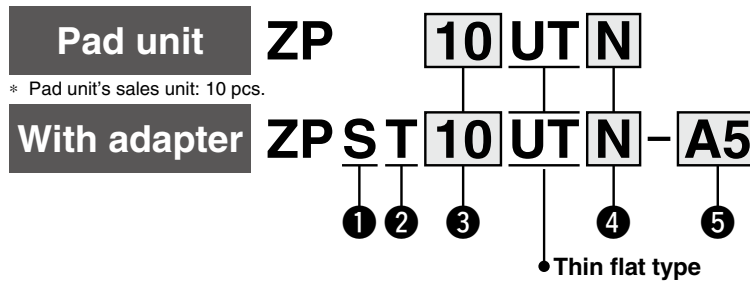

① Adapter material

S	Stainless steel (Stainless steel 304)
----------	---------------------------------------

② Vacuum inlet direction

T	Vertical
----------	----------

③ Pad diameter

10	ø10
13	ø13
16	ø16

④ Material

N	NBR
S	Silicone rubber *1 *2
U	Urethane rubber
F	FKM
GN	Conductive NBR
GS	Conductive silicone rubber

*1 Compliant with the FDA (USA Food and Drug Administration) regulation 21CFR§177.2600 for "Rubber articles intended for repeated use"

*2 Compliant with the standards for "Rubber apparatus (excluding baby drinking apparatus) and containers/packaging" (D3) (Partial revision: Ministry of Health, Labour, and Welfare Notification No. 595, 2012) in Section 3 "Apparatus and Containers/Packaging" of the Food Sanitation Act, Article 18 "Specifications and Standards for Food and Food Additives, etc." (Ministry of Health and Welfare Notification No. 370, 1959)

With adapter

⑤ Vacuum inlet

Type	Symbol	Size	Pad diameter
			All sizes
Female thread	A5	M5 x 0.8	○
	A6	M6 x 1	○
One-touch fitting	B4	M4 x 0.7	○
	B5	M5 x 0.8	○



Basic Pad

Thin Flat Type with Ribs

ZP Series

For pad units and pads with an adapter (stainless steel type): The standard product is a secondary battery compatible product. For details on specifications and dimensions, refer to the [Web Catalog](#).



How to Order

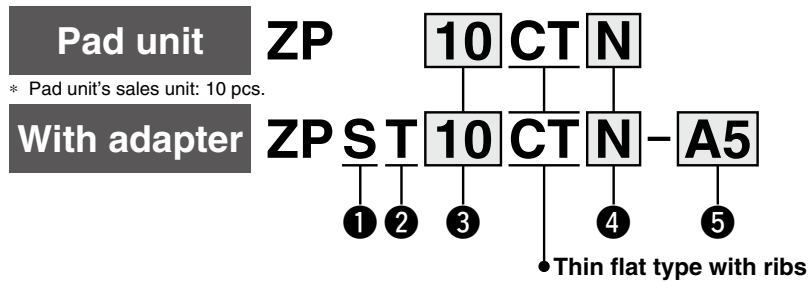

① Adapter material

S	Stainless steel (Stainless steel 304)
----------	---------------------------------------

② Vacuum inlet direction

T	Vertical
----------	----------

③ Pad diameter

10	ø10
13	ø13
16	ø16

④ Material

N	NBR
S	Silicone rubber*1 *2
U	Urethane rubber
F	FKM
GN	Conductive NBR
GS	Conductive silicone rubber

*1 Compliant with the FDA (USA Food and Drug Administration) regulation 21CFR§177.2600 for "Rubber articles intended for repeated use"

*2 Compliant with the standards for "Rubber apparatus (excluding baby drinking apparatus) and containers/packaging" (D3) (Partial revision: Ministry of Health, Labour, and Welfare Notification No. 595, 2012) in Section 3 "Apparatus and Containers/Packaging" of the Food Sanitation Act, Article 18 "Specifications and Standards for Food and Food Additives, etc." (Ministry of Health and Welfare Notification No. 370, 1959)

With adapter

⑤ Vacuum inlet

Type	Symbol	Size	Pad diameter
			All sizes
Male thread	A5	M5 x 0.8	○
	A6	M6 x 1	○
Female thread	B4	M4 x 0.7	○
	B5	M5 x 0.8	○



Basic Pad Deep Type ZP Series

For pad units and pads with an adapter (stainless steel type): The standard product is a secondary battery compatible product. For details on specifications and dimensions, refer to the [Web Catalog](#).



How to Order

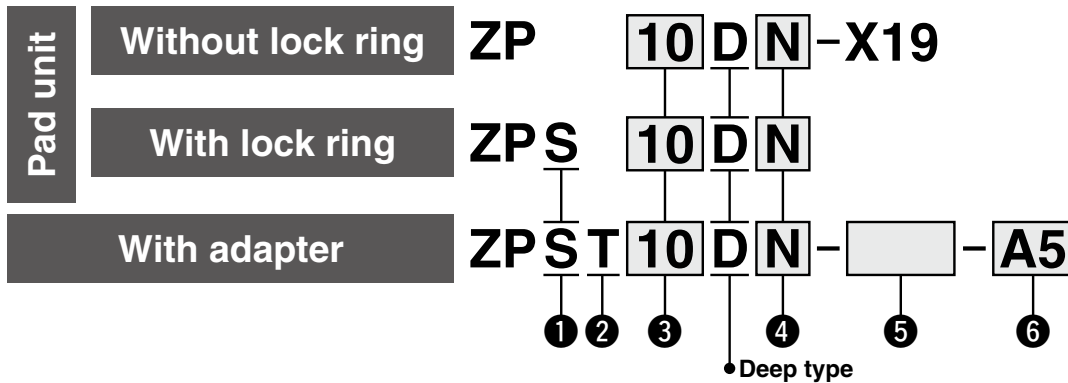

1 Adapter (Lock ring) material

S	Stainless steel (Stainless steel 304)
---	---------------------------------------

3 Pad diameter

10	ø10
16	ø16
25	ø25
40	ø40

4 Material

N	NBR
S	Silicone rubber*1 *2
U	Urethane rubber
F	FKM
GN	Conductive NBR
GS	Conductive silicone rubber

2 Vacuum inlet direction

T	Vertical
---	----------

*1 Compliant with the FDA (USA Food and Drug Administration) regulation 21CFR§177.2600 for "Rubber articles intended for repeated use"

*2 Compliant with the standards for "Rubber apparatus (excluding baby drinking apparatus) and containers/packaging" (D3) (Partial revision: Ministry of Health, Labour, and Welfare Notification No. 595, 2012) in Section 3 "Apparatus and Containers/Packaging" of the Food Sanitation Act, Article 18 "Specifications and Standards for Food and Food Additives, etc." (Ministry of Health and Welfare Notification No. 370, 1959)

With adapter

5 Vacuum inlet

Type	Symbol	Size	Pad diameter [mm]		
			ø10, ø16	ø25	ø40
Male thread	AS5	M5 x 0.8	○*1	○*1	—
	AS6	M6 x 1	○*1	○*1	○*1
	AG01	G1/8	○*1	○*1	—
	AG02	G1/4	—	—	○*1
Female thread	Nil	M3 x 0.5	○ (6) Connection thread: A5/A6	○ (6) Connection thread: A6	○ (6) Connection thread: A6
		M5 x 0.8	—	○ (6) Connection thread: A8	○ (6) Connection thread: A8
	B5	M5 x 0.8	○*1	○*1	—
	B6	M6 x 1	○*1	○*1	○*1
	B8	M8 x 1.25	—	○*1	○*1
	B01	Rc1/8	○*1	○*1	○*1
	BG01	G1/8	○*1	○*1	—
	BG02	G1/4	—	—	○*1

*1 Use the connection thread.

6 Connection thread

Type	Symbol	Size	Pad diameter [mm]		
			ø10, ø16	ø25	ø40
Male thread	A5	M5 x 0.8	○*2	—	—
	A6	M6 x 1	○*2	○*2	○*2
	A8	M8 x 1	—	○*2	○*2

*2 With a (female) vacuum inlet

Lock ring unit

Part no.	Pad diameter [mm]
ZPSL1	ø10, ø16
ZPSL2	ø25
ZPSL3	ø40



Compact Type

Flat Type

ZP3 Series

Pad diameter: $\varnothing 1.5$, $\varnothing 2$, $\varnothing 3.5$

For pad units and pads with an adapter (stainless steel type): The standard product is a secondary battery compatible product. For details on specifications and dimensions, refer to the [Web Catalog](#).



How to Order

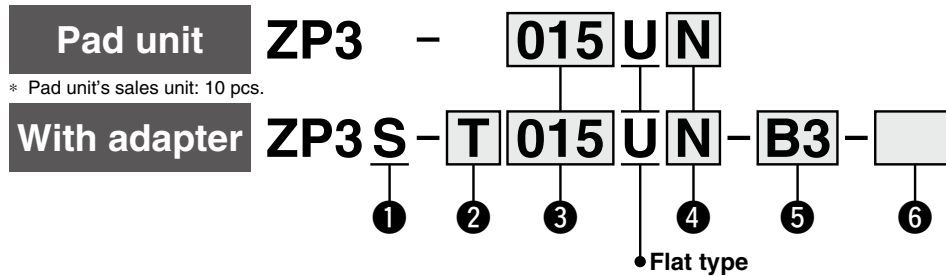

1 Adapter material

S	Stainless steel (Stainless steel 304)
----------	---------------------------------------

2 Vacuum inlet direction

Nil	Pad unit
T	Vertical
Y	Lateral

3 Pad diameter

015	$\varnothing 1.5$
02	$\varnothing 2$
035	$\varnothing 3.5$

4 Material

N	NBR
S	Silicone rubber*1 *2
U	Urethane rubber
F	FKM
GN	Conductive NBR
GS	Conductive silicone rubber

With adapter

5 Connection thread/ 6 Vacuum inlet

○: ZP3S-T/Vertical ●: ZP3S-Y/Lateral

5 Connection thread			6 Vacuum inlet			Pad diameter
Type	Symbol	Size	Type	Symbol	Size	All sizes
Male thread	A3	M3 x 0.5	—	Nil	—*1	○
	A6	M6 x 0.75	Female thread	B3	M3 x 0.5	○
Female thread	B3	M3 x 0.5	—	Nil	—*1	○
			Female thread	B3	M3 x 0.5	●

*1 Use the connection thread.

*1 Compliant with the FDA (USA Food and Drug Administration) regulation 21CFR§177.2600 for "Rubber articles intended for repeated use"

*2 Compliant with the standards for "Rubber apparatus (excluding baby drinking apparatus) and containers/packaging" (D3) (Partial revision: Ministry of Health, Labour, and Welfare Notification No. 595, 2012) in Section 3 "Apparatus and Containers/Packaging" of the Food Sanitation Act, Article 18 "Specifications and Standards for Food and Food Additives, etc." (Ministry of Health and Welfare Notification No. 370, 1959)



Compact Type Flat Type with Groove

ZP3 Series

Pad diameter: $\varnothing 4$, $\varnothing 6$, $\varnothing 8$, $\varnothing 10$, $\varnothing 13$, $\varnothing 16$

For pad units and pads with an adapter (stainless steel type): The standard product is a secondary battery compatible product. For details on specifications and dimensions, refer to the [Web Catalog](#).

How to Order

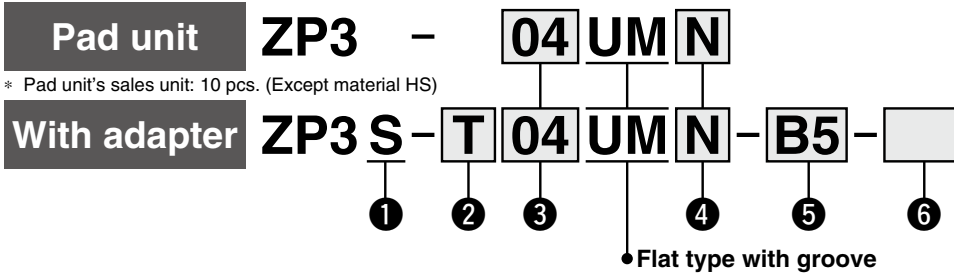

1 Adapter material

S	Stainless steel (Stainless steel 304)
----------	---------------------------------------

2 Vacuum inlet direction

Nil	Pad unit
T	Vertical
Y	Lateral

3 Pad diameter

04	$\varnothing 4$
06	$\varnothing 6$
08	$\varnothing 8$
10	$\varnothing 10$
13	$\varnothing 13$
16	$\varnothing 16$

4 Material

N	NBR
S	Silicone rubber*1*2
U	Urethane rubber
F	FKM
GN	Conductive NBR
GS	Conductive silicone rubber
HS	Semiconductive silicone rubber

With adapter

5 Connection thread/ 6 Vacuum inlet ○: ZP3S-T/Vertical ●: ZP3S-Y/Lateral

5 Connection thread			6 Vacuum inlet			Pad diameter [mm]	
Type	Symbol	Size	Type	Symbol	Size	$\varnothing 4$ to $\varnothing 8$	$\varnothing 10$ to $\varnothing 16$
Male thread	A5	M5 x 0.8	—	Nil	Use the connection thread.	○	○
	A10	M10 x 1	Female thread	B5	M5 x 0.8	○	—
	A12	M12 x 1	Female thread	B5	M5 x 0.8	—	○
Female thread	B5	M5 x 0.8	—	Nil	Use the connection thread.	○	○
			Female thread	B5	M5 x 0.8	●	●

*1 Compliant with the FDA (USA Food and Drug Administration) regulation 21CFR§177.2600 for "Rubber articles intended for repeated use"

*2 Compliant with the standards for "Rubber apparatus (excluding baby drinking apparatus) and containers/packaging" (D3) (Partial revision: Ministry of Health, Labour, and Welfare Notification No. 595, 2012) in Section 3 "Apparatus and Containers/Packaging" of the Food Sanitation Act, Article 18 "Specifications and Standards for Food and Food Additives, etc." (Ministry of Health and Welfare Notification No. 370, 1959).



Compact Type

Bellows Type

ZP3 Series

Pad diameter: $\varnothing 4$, $\varnothing 6$, $\varnothing 8$

For pad units and pads with an adapter (stainless steel type): The standard product is a secondary battery compatible product. For details on specifications and dimensions, refer to the [Web Catalog](#).



How to Order

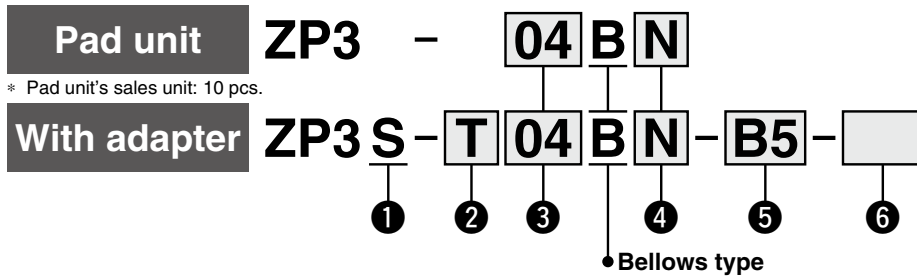

1 Adapter material

S	Stainless steel (Stainless steel 304)
----------	---------------------------------------

2 Vacuum inlet direction

Nil	Pad unit
T	Vertical
Y	Lateral

3 Pad diameter

04	$\varnothing 4$
06	$\varnothing 6$
08	$\varnothing 8$

4 Material

N	NBR
S	Silicone rubber*1 *2
U	Urethane rubber
F	FKM
GN	Conductive NBR
GS	Conductive silicone rubber

With adapter

5 Connection thread/ 6 Vacuum inlet

○: ZP3S-T/Vertical ●: ZP3S-Y/Lateral

5 Connection thread			6 Vacuum inlet			Pad diameter
Type	Symbol	Size	Type	Symbol	Size	All sizes
Male thread	A5	M5 x 0.8	—	Nil	Use the connection thread.	○
	A10	M10 x 1	Female thread	B5	M5 x 0.8	○
Female thread	B5	M5 x 0.8	—	Nil	Use the connection thread.	○
			Female thread	B5	M5 x 0.8	●

*1 Compliant with the FDA (USA Food and Drug Administration) regulation 21CFR§177.2600 for "Rubber articles intended for repeated use"

*2 Compliant with the standards for "Rubber apparatus (excluding baby drinking apparatus) and containers/packaging" (D3) (Partial revision: Ministry of Health, Labour, and Welfare Notification No. 595, 2012) in Section 3 "Apparatus and Containers/Packaging" of the Food Sanitation Act, Article 18 "Specifications and Standards for Food and Food Additives, etc." (Ministry of Health and Welfare Notification No. 370, 1959)



Compact Type Bellows Type with Ribs

ZP3 Series

Pad diameter: $\varnothing 10, \varnothing 13, \varnothing 16$

For pad units and pads with an adapter (stainless steel type): The standard product is a secondary battery compatible product. For details on specifications and dimensions, refer to the [Web Catalog](#).



How to Order

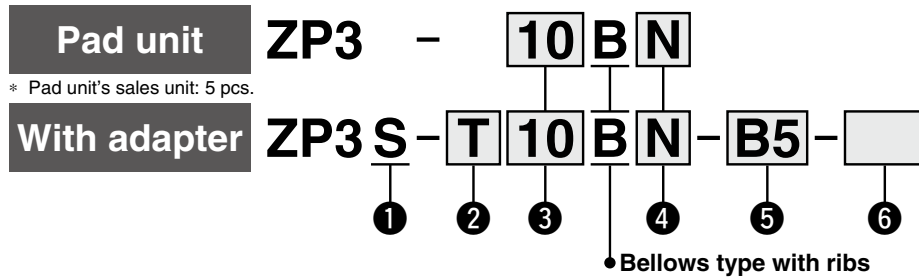

1 Adapter material

S	Stainless steel (Stainless steel 304)
----------	---------------------------------------

2 Vacuum inlet direction

Nil	Pad unit
T	Vertical
Y	Lateral

3 Pad diameter

10	$\varnothing 10$
13	$\varnothing 13$
16	$\varnothing 16$

4 Material

N	NBR
S	Silicone rubber*1 *2
U	Urethane rubber
F	FKM
GN	Conductive NBR
GS	Conductive silicone rubber

With adapter

5 Connection thread/ 6 Vacuum inlet

○: ZP3S-T/Vertical ●: ZP3S-Y/Lateral

5 Connection thread			6 Vacuum inlet			Pad diameter
Type	Symbol	Size	Type	Symbol	Size	All sizes
Male thread	A5	M5 x 0.8	—	Nil	Use the connection thread.	○
	A12	M12 x 1	Female thread	B5	M5 x 0.8	○
Female thread	B5	M5 x 0.8	—	Nil	Use the connection thread.	○
			Female thread	B5	M5 x 0.8	●

*1 Compliant with the FDA (USA Food and Drug Administration) regulation 21CFR§177.2600 for "Rubber articles intended for repeated use"

*2 Compliant with the standards for "Rubber apparatus (excluding baby drinking apparatus) and containers/packaging" (D3) (Partial revision: Ministry of Health, Labour, and Welfare Notification No. 595, 2012) in Section 3 "Apparatus and Containers/Packaging" of the Food Sanitation Act, Article 18 "Specifications and Standards for Food and Food Additives, etc." (Ministry of Health and Welfare Notification No. 370, 1959)



Vacuum Pad

ZP3P-PT Series

Pad diameter: $\varnothing 20$, $\varnothing 25$, $\varnothing 35$, $\varnothing 50$

For pad units and pads with an adapter (Excludes the M12 x 1.75 type):
The standard product is a secondary battery compatible product. For
details on specifications and dimensions, refer to the [Web Catalog](#).



How to Order

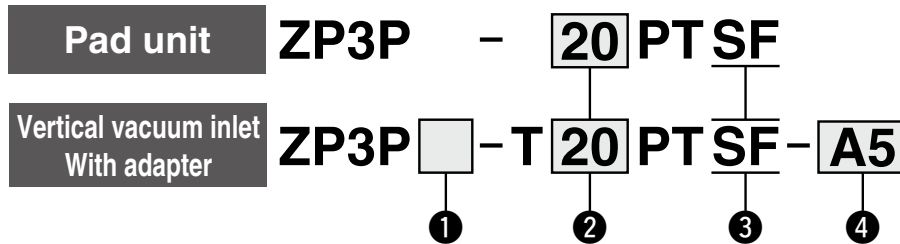

① Adapter material

Nil	Aluminum
S	Stainless steel (Stainless steel 304)

② Pad diameter

20	$\varnothing 20$
25	$\varnothing 25$
35	$\varnothing 35$
50	$\varnothing 50$

③ Pad material

SF	Silicone rubber*1, *2
----	-----------------------

*1 Compliant with the FDA (USA Food and Drug Administration) regulation 21CFR§177.2600 for "Rubber articles intended for repeated use"

*2 Compliant with the standards for "Rubber apparatus (excluding baby drinking apparatus) and containers/packaging" (D3) (Partial revision: Ministry of Health, Labour, and Welfare Notification No. 595, 2012) in Section 3 "Apparatus and Containers/Packaging" of the Food Sanitation Act, Article 18 "Specifications and Standards for Food and Food Additives, etc." (Ministry of Health and Welfare Notification No. 370, 1959).

With adapter

④ Mounting thread size

Type	Symbol	Size	$\varnothing 20$	$\varnothing 25$	$\varnothing 35$	$\varnothing 50$
Male thread	A5	M5 x 0.8	●	●	—	—
	AG1	G1/8	●	●	—	—
	AG2	G1/4	—	—	●	●
	AG3	G3/8	—	—	●	●
Female thread	B5	M5 x 0.8	●	●	—	—
	B8	M8 x 1.25	—	—	●	●



Vacuum Pad

2.5-Stage Bellows Type

ZP3P-JT Series

For pad units and pads with an adapter (Vacuum inlet: Excludes the built-in One-touch fitting type): The standard product is a secondary battery compatible product. For details on specifications and dimensions, refer to the [Web Catalog](#).

How to Order

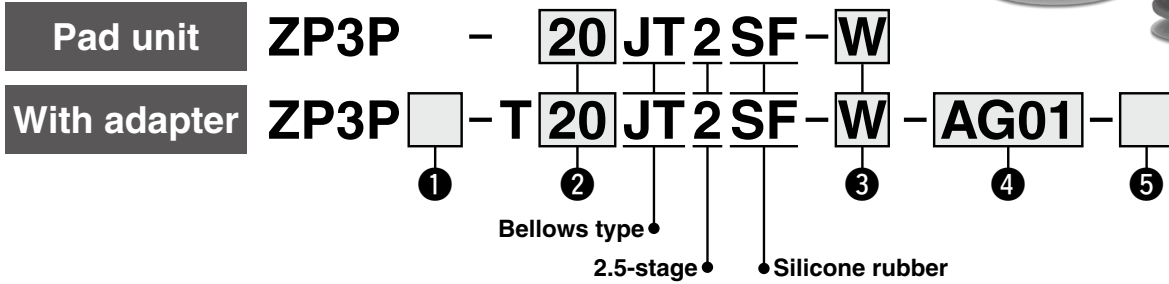
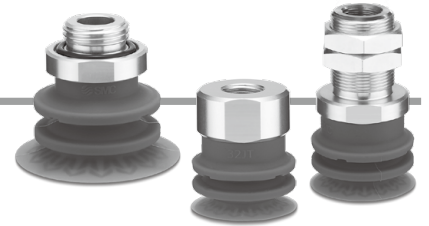

1 Adapter material

Nil	Aluminum
S	Stainless steel (Stainless steel 304)

2 Pad diameter

20	ø20
25	ø25
32	ø32
40	ø40
50	ø50

3 Attachment

W	With attachment
WM	With mesh attachment
WF	With flat attachment

With adapter

4 Connection thread/5 Vacuum inlet

Type	4 Connection thread			5 Vacuum inlet			Pad diameter [mm]	
	Thread	Symbol	Size	Thread	Symbol	Size	ø20, ø25	ø32, ø40, ø50
Direct mounting	Male thread	AG01	G1/8	—	Nil	—*1	●	●
		AG02	G1/4				●	●
		AG03	G3/8				●	●
		AG04	G1/2				—	●
	Female thread	BG01	G1/8	—	Nil	—*1	●	—
		BG02	G1/4				—	●
Plate mounting	Male thread	A16	M16 x 1	Female thread	B01	Rc1/8	●	—
					BN01	NPT1/8	—	—
		A20	M20 x 1	Female thread	B02	Rc1/4	—	●
					BN02	NPT1/4	—	●

*1 Use the connection thread.

Pad, adapter assembly, and mounting nuts are included but do not come assembled.

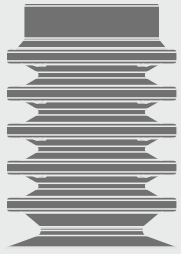

Vacuum Pad

5.5-Stage Bellows Type

ZP3P-JT Series

For pad units and pads with an adapter (Vacuum inlet: Excludes the built-in One-touch fitting type): The standard product is a secondary battery compatible product. For details on specifications and dimensions, refer to the [Web Catalog](#).

How to Order



Pad unit ZP3P - **20** **JT** **5** **SF** - **WG**

With adapter ZP3P **1** - **T** **20** **JT** **5** **SF** - **AG01** - **4**

* With guide attachment

• Bellows type • 5.5-stage • Silicone rubber • With guide attachment

1 Adapter material

Nil	Aluminum
S	Stainless steel (Stainless steel 304)

2 Pad diameter

20	ø20
25	ø25
32	ø32
40	ø40
50	ø50

With adapter

3 Connection thread/4 Vacuum inlet

Type	3 Connection thread			4 Vacuum inlet			Pad diameter [mm]	
	Thread	Symbol	Size	Thread	Symbol	Size	ø20, ø25	ø32 to ø50
Direct mounting	Male thread	AG01	G1/8	—	Nil	—*1	●	●
		AG02	G1/4				—	●
	Female thread	BG01	G1/8				●	—
		BG02	G1/4				—	●
Plate mounting	Male thread	A16	M16 x 1	Female thread	B01	Rc1/8	●	—
			BN01		NPT1/8	—	—	
		A20	M20 x 1	Female thread	B02	Rc1/4	—	●
					BN02	NPT1/4	—	—

*1 Use the connection thread.

Pad, adapter assembly, and mounting nuts are included but do not come assembled.



Vacuum Pad

Flat Type with Ribs Bellows Type

ZP3C Series

For pad units and pads with an adapter: The standard product is a secondary battery compatible product. For details on specifications and dimensions, refer to the [Web Catalog](#).

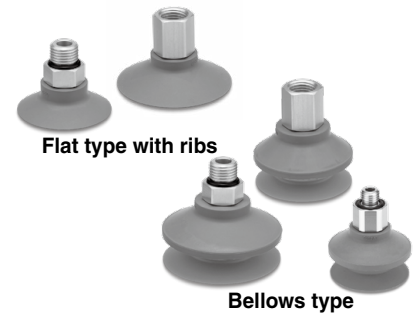

How to Order

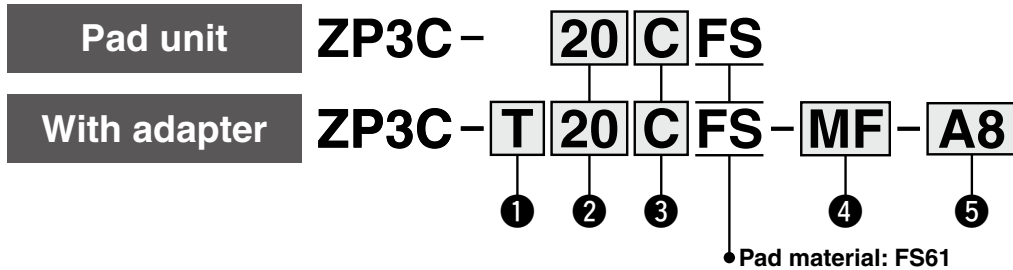

① Vacuum inlet direction

Nil	Pad unit
T	Vertical

② Pad diameter

20	ø20
25	ø25
32	ø32
40	ø40
50	ø50

③ Pad form

C	Flat type with ribs
B	Bellows type

④ Mesh filter

Nil	Without mesh filter
MF	With mesh filter

⑤ Connection thread

Type	Thread	Symbol	Size	Pad diameter [mm]	
				ø20 to ø32	ø40, ø50
Direct mounting	Male thread	A8	M8 x 1	●	—
		A10	M10 x 1	—	●
		AG01	G1/8	●	—
	Female thread	AG02	G1/4	—	●
		BG01	G1/8	●	—
		BG02	G1/4	—	●

* Use the connection thread for the vacuum inlet.

Specifications

Pad/Mesh filter specifications

Pad	Material	FS61 (Fluoro-based rubber)
	Color	Green
	Hardness (Shore A: ±5°)	60
Mesh filter	Opening: 250 μm	

Adapter specifications

Connection	Male thread		Female thread	
	ø20 to ø32	ø40, ø50	ø20 to ø32	ø40, ø50
Pad diameter				
Connection thread	M8 x 1 G1/8	M10 x 1 G1/4	G1/8	G1/4
Vacuum inlet	Use the connection thread.			

Vacuum Pad/Bowl Shape with Non-slip Feature

ZP3M Series

For pads with an adapter: The standard product is a secondary battery compatible product. For details on specifications and dimensions, refer to the [Web Catalog](#).

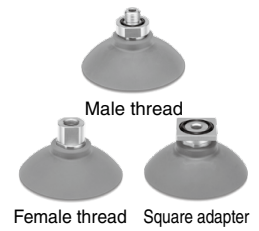

How to Order

With adapter **ZP3M - T 63 R FS - A16 - MF**



1 Vacuum inlet direction

T	Vertical
----------	----------

2 Pad diameter

32	ø32
40	ø40
50	ø50
63	ø63
80	ø80
100	ø100

3 Material

Symbol	Material	Color
FS	FS61 (Fluoro-based rubber)	Green

4 Connection thread and type

Mounting	Type	Symbol	Size	Pad diameter	
				ø32 to ø50	ø63 to ø100
Direct mounting	Male thread	A10	M10 x 1.0	●	—
		A16	M16 x 1.5	—	●
		AG02	G1/4	●	●
	Female thread	B14	M14 x 1.0	●	●
		BG02	G1/4	●	●
		BG03	G3/8	●	●
Square adapter	S32	□31.8	●	●	

5 Mesh filter

Nil	None
MF	With mesh filter

Mesh filter unit

Part no.	Pad diameter	
	ø32 to ø50	ø63 to ø100
ZPMF-60-D13	●	—
ZPMF-60-D18	—	●

* The adapter and pad are adhered to each other and cannot be disassembled.

Specifications

Pad Material

Material	FS61 (Fluoro-based rubber)
Color of rubber	Green
Rubber hardness (Shore A: ±5°)	60
Operating temperature range*1	0°C to 200°C
Ambient temperature	0°C to 150°C

*1 Surface temperature of the workpiece to be adsorbed

Adapter Specifications

Connection	Male thread		Female thread		Square adapter
Pad diameter	ø32 to ø50	ø63 to ø100	ø32 to ø50	ø63 to ø100	ø32 to ø100
Size	M10 x 1.0 G1/4	M16 x 1.5 G1/4	M14 x 1.0 G1/4 G3/8		□31.8
Vacuum inlet	Use the connection thread and type.				

Pad Specifications

Part no.	Horizontal holding force [N]*1		Minimum curvature radius for adsorption [mm]*2
	Without oil	With oil	
ZP3M-T32RFS	47	21	14
ZP3M-T40RFS	81	53	15
ZP3M-T50RFS	111	74	20
ZP3M-T63RFS	170	108	27.5
ZP3M-T80RFS	231	178	36
ZP3M-T100RFS	387	224	46

*1 These are actual measurement values when flat workpieces were adsorbed and are not guaranteed values. (According to the SMC test)

The values vary depending on the conditions (shape, surface roughness, oil type, oil amount, and other conditions) of the workpiece.

*2 These are actual measurement values when cylindrical workpieces were adsorbed and are not guaranteed values. (According to the SMC test)

Mesh Filter Specifications

Mesh filter	60
Opening	250 μm

For grippers without a sensor: The standard product is a secondary battery compatible product. For details on specifications and dimensions, refer to the [Web Catalog](#).

Bernoulli Gripper ZNC Series

How to Order

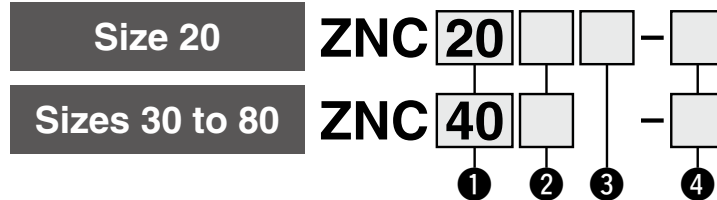

1 Body size

20	ø20 mm
30	ø30 mm
40	ø40 mm
60	ø60 mm
80	ø80 mm

2 Body material

Nil	Aluminum	
P	Resin	
S	Stainless steel	

4 Attachment

Nil	Basic type (Without attachment)	
PN	With stoppers	NBR (Black)
PS		Silicone rubber (White)
VP	With vibration suppression cover*1	Resin
VS		Stainless steel

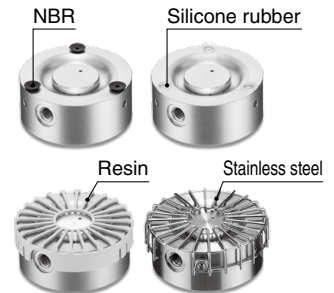

3 Mounting plate (Size 20)

Nil	Without mounting plate	
T	With mounting plate	Aluminum
TS		Stainless steel



*1 Refer to the Table 1. With Vibration Suppression Cover for the size and material.

* Stoppers cannot be retrofitted.

* Vibration suppression cover can be retrofitted to the basic type.

* The vibration suppression cover cannot be used with the type with stoppers.

* The mounting plate is shipped together with the product but does not come assembled. Single unit part nos. ⇒ [Web Catalog](#)

* The piping methods for types with and without a mounting plate are shown in Table 2 below.

Table 1. With Vibration Suppression Cover

Symbol	Material	Body size symbol	Body material		
			Aluminum	Resin	Stainless steel
VP	Resin	20	—	—	—
		30	—	—	—
		40	●	●	—
		60	—	—	—
		80	—	—	—
VS	Stainless steel	20	●	●	●
		30	●	●	●
		40	●	—	●
		60	●	●	●
		80	●	●	●

Table 2. Size 20 Piping (Refer to the [Web Catalog](#) for details on how to mount the product.)

	Without mounting plate	
	Side ported	Body ported (Requires no piping)
Without mounting plate	 Can be used by blocking the supply port on the top surface of the product with the mounting surface and connecting from the side port	 Can be used by connecting the piping inside the mounting surface with the supply port on the top surface of the product
With mounting plate	Top ported	Side ported
	 Can be used by mounting a fitting on the supply port on the top surface of the product and connecting	 Can be used by blocking the supply port on the top surface of the product with the mounting plate and connecting from the side port

* An O-ring (5.7 x 3.7 x 1) and a plug are shipped together with the product as accessories.

Attachments/Part Nos.

Stopper ZNCM-PS 2

Material

PN	NBR (Black)
PS	Silicone rubber (White)

Stopper size

Symbol	Body size
1	20, 30
2	40, 60, 80

* Stopper size 1: With 3 stoppers

Stopper size 2: With 3 stoppers and 3 spring pins

For replacement instructions ⇒ Refer to the [Web Catalog](#).

Vibration suppression cover ZNCM-40 VP

Body size

20	ø20 mm	60	ø60 mm
30	ø30 mm	80	ø80 mm
40	ø40 mm		

Material

VP	Resin
VS	Stainless steel

* Material: Resin is only selectable for body size 40.

* For stainless steel:

Body sizes ø20mm and ø30 mm: With 2 mounting screws

Body sizes ø40 mm, ø60 mm, and ø80 mm: With 3 mounting screws

Bernoulli Gripper With Coanda Grip ZNC-C Series

For grippers without a sensor: The standard product is a secondary battery compatible product. For details on specifications and dimensions, refer to the [Web Catalog](#).



How to Order

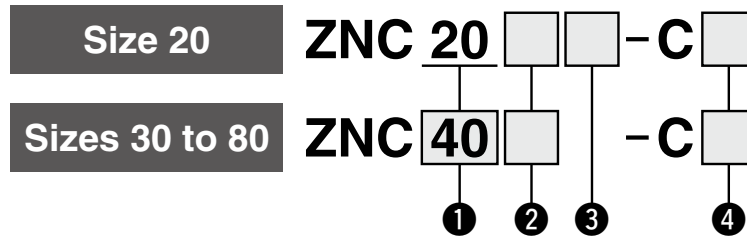

① Body size

20	ø20 mm
30	ø30 mm
40	ø40 mm
60	ø60 mm
80	ø80 mm

② Body material

Nil	Aluminum
S	Stainless steel

③ Mounting plate

Nil	None
T	Aluminum
TS	Stainless steel

* The mounting plate is shipped together with the product but does not come assembled.

* The piping methods for types with and without a mounting plate are shown in Table 1 below.

④ Attachment

Nil	Without vibration suppression cover
V	With vibration suppression cover

* It is not possible to additionally install or remove the vibration suppression cover.

Table 1. Piping

	Body ported (Requires no piping)
Without mounting plate	<p>Can be used by connecting the piping inside the mounting surface with the supply port on the top surface of the product</p>
	Top ported
With mounting plate	<p>Can be used by mounting a fitting on the supply port on the top surface of the product and connecting</p>

Coanda Grip Only / Part No.

ZNCM - 40 C

Body size ●

20	ø20 mm	60	ø60 mm
30	ø30 mm	80	ø80 mm
40	ø40 mm		

Vacuum Regulator

RoHS

25A-IRV10/20 Series



How to Order

Standard connections 25A-IRV 20 - [] C08 [] []

Series compatible with secondary batteries

Body size

10	Max. flow 140 L/min (ANR)
20	Max. flow 240 L/min (ANR)

Fittings

Nil	Straight
L	Elbow

Connection tubing O.D.

Symbol	Tubing O.D.	IRV10	IRV20
C06	Metric	●	●
C08		●	●
C10		—	●

Accessory ② [Supplied with product]

Nil	None*1
GN	Gauge nut assembly*2

*1 Two plug nuts are mounted on the gauge port. When the Rc1/8 port is required, please order the optional gauge nut assembly P601010-130 separately.

*2 One plug nut, one gauge nut (Rc1/8), and two clips are included. The pressure gauge and digital pressure switch are not included.

Accessory ① [Supplied with product]

Nil	None
B	With bracket

Single sided connections 25A-IRV 20 A - [] C08 [] []

Series compatible with secondary batteries

Body size

10	Max. flow 140 L/min (ANR)
20	Max. flow 240 L/min (ANR)

Single sided connections

A	Single sided connections
---	--------------------------

Fittings

Nil	Straight
L	Elbow

Connection tubing O.D.

Symbol	Tubing O.D.	IRV10A	IRV20A
C06	Metric	●	●
C08		●	●
C10		—	●

Accessory ② [Supplied with product]

Nil	None*1
GN	Gauge nut assembly*2

*1 Two plug nuts are mounted on the gauge port. When the Rc1/8 port is required, please order the optional gauge nut assembly P601010-130 separately.

*2 One gauge nut (Rc1/8) and one clip are included. The pressure gauge and digital pressure switch are not included.

Accessory ① [Supplied with product]

Nil	None
B	With bracket

* This product cannot be used in environments containing chemical agents such as hydrofluoric acid, etc.

* The 25A- series specifications and dimensions are the same as those of the standard model.

For details, refer to the [Web Catalog](#).