

Environment

Dust-tight/Water-jet-proof (IP65 Equivalent/IP67 Equivalent)

Dust-tight/Water-jet-proof (IP65 Equivalent)

Clean Room Specification

Secondary Battery Compatible

Dust-tight/Water-jet-proof (IP65 Equivalent/IP67 Equivalent)

Rod Type LEY□E-X8 Size 25, 32, 40

Battery-less Absolute (Step Motor 24 VDC)

p. 887

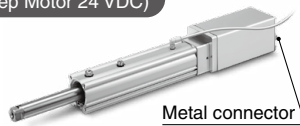

Rod Type LEY-X7 Size 25, 32, 40

Incremental (Step Motor 24 VDC)

Incremental (Servo Motor 24 VDC)

p. 903

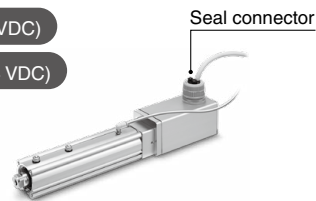

Dust-tight/Water-jet-proof (IP65 Equivalent)

Rod Type LEY-X5 Size 25, 32

Incremental (Step Motor 24 VDC)

Incremental (Servo Motor 24 VDC)

p. 917

Rod Type LEY-X5 Size 25, 32

AC Servo Motor

p. 925, 931

Rod Type LEY Series Size 63

AC Servo Motor

p. 473, 489

* Option

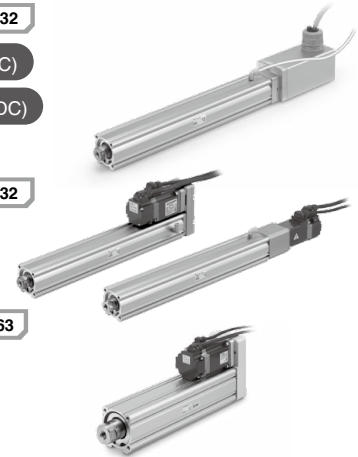

Clean Room Specification

p. 938

Slider Type Ball Screw Drive

11-LEFS Series

Incremental (Step Motor 24 VDC)

Incremental (Servo Motor 24 VDC)

p. 943

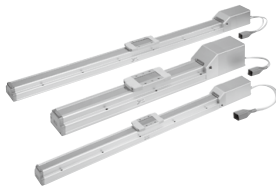

Slider Type Ball Screw Drive

11-LEFS Series

AC Servo Motor

p. 953, 955

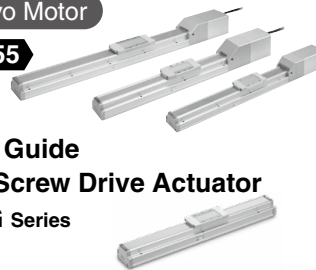

Support Guide for Ball Screw Drive Actuator

11-LEFG Series

p. 961

High Rigidity Slider Type Ball Screw Drive

11-LEJS Series

AC Servo Motor

p. 967, 969



Secondary Battery Compatible

p. 974

Slider Type Ball Screw Drive

25A-LEFS Series

Incremental (Step Motor 24 VDC)

Incremental (Servo Motor 24 VDC)

p. 975

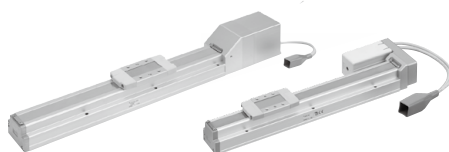

Slider Type Ball Screw Drive

25A-LEFS Series

AC Servo Motor

p. 979, 980



High Rigidity Slider Type Ball Screw Drive

25A-LEJS Series

AC Servo Motor

p. 981, 982



Rod Type 25A-LEY Series

Incremental (Step Motor 24 VDC)

Incremental (Servo Motor 24 VDC)

p. 983





Rod Type 25A-LEY Series

AC Servo Motor

p. 987, 989

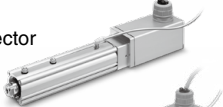
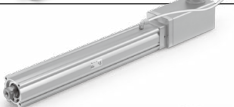

Series	Dust-tight/Water-jet-proof		Size	Battery-less absolute (Step motor 24 VDC)	Incremental (Step motor 24 VDC)	Incremental (Servo motor 24 VDC)	AC servo motor
	IP65 equivalent/IP67 equivalent	IP65 equivalent					
LEY□E-X8 Metal connector 	●		25 32 40	●			
LEY-X7 Seal connector 	●		25 32 40		●	●	
LEY-X5 		●	25 32		●	●	●
LEY63□□□-□P 		●	63				●

Enclosure

Degrees of Protection

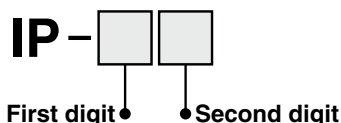

First Digit: Degree of protection against solid foreign objects

Degrees	Degree of protection
0	Not protected
1	Protected against solid foreign objects of 50 mmø and larger
2	Protected against solid foreign objects of 12 mmø and larger
3	Protected against solid foreign objects of 2.5 mmø and larger
4	Protected against solid foreign objects of 1.0 mmø and larger
5	Dust protected
6	Dust-tight

Second Digit: Degree of protection against water

Degrees	Degree of protection	
0	Not protected	—
1	Protected against vertically falling water droplets	Drip-proof type 1
2	Protected against vertically falling water droplets when enclosure is tilted up to 15°	Drip-proof type 2
3	Protected against rainfall when enclosure is tilted up to 60°	Rainproof type
4	Protected against splashing water	Splashproof type
5	Protected against water jets	Water-jet-proof type
6	Protected against powerful water jets	Powerful water-jet-proof type
7	Protected against the effects of temporary immersion in water	Immersion type
8	Protected against the effects of continuous immersion in water	Submersible type

Example) Degrees of protection

Degrees of protection			Details
IP65	Solid foreign objects	Dust-tight	Dust particles are prevented from entering the device.
	Entry of water	Water-jet-proof*1	The direct application of water jets to the device from any direction will not cause any damage.
IP67	Solid foreign objects	Dust-tight	Dust particles are prevented from entering the device.
	Entry of water	Immersion*1	The amount of water that enters the device when the actuator (in the stopped state) is submerged in up to 1 m of water for up to 30 mins will not cause any damage.

*1 Be sure to take appropriate protective measures if the product is to be used in an environment where it will be constantly exposed to water or fluids other than water splash.
 In particular, the product cannot be used in environments where oils, such as cutting oil or cutting fluid, are present.

Environment

Enclosure: IP65^{*1} equivalent/IP67 equivalent

LEY-X8 Series Size 25, 32, 40

Battery-less Absolute (Step Motor 24 VDC)

p. 887

Scraper

Lube-retainer

Retains grease oil film

Metal connector

Prevents dust and water droplets from entering between the cable and motor cover

Aluminum cover

Protects the motor

Grease supply holes

Tubing

* Order the tubing separately.

Vent hole

Reduces internal pressure fluctuations in order to prevent dust and water droplets from entering the device

* Be sure to attach tubing.

Mounting groove for auto switches

Water-resistant type

For checking the limit and the intermediate signal

* Order the water-resistant 2-color indicator solid state auto switch separately.

*1 Testing of IP65 has also been carried out.

Battery-less absolute encoder compatible

Application Examples

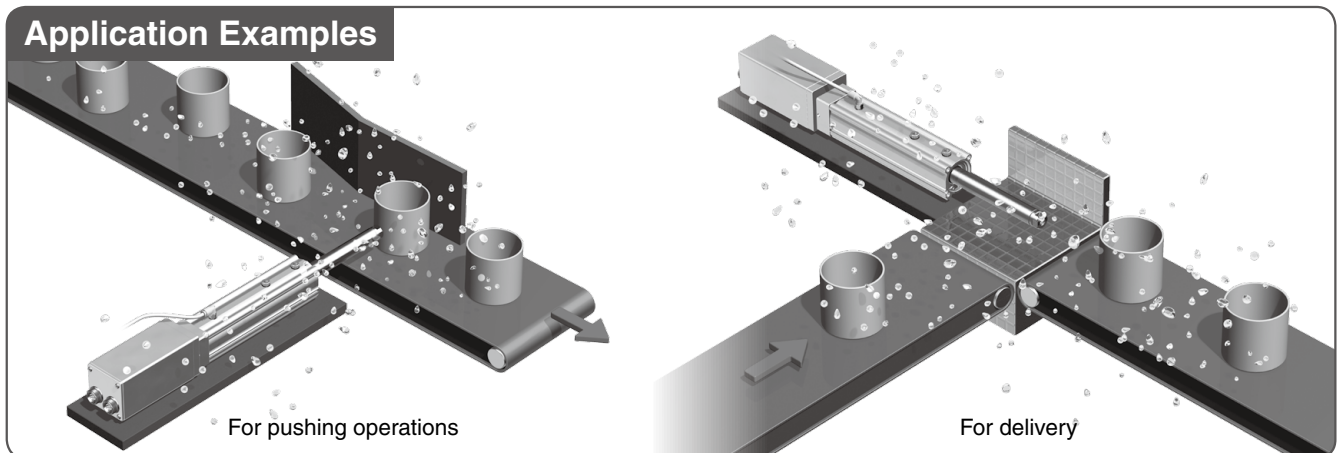

Model Selection

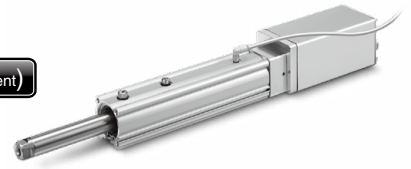

Speed-Work Load Graph (Guide)

Horizontal

LEY25□E-X8 ▨ for acceleration/deceleration: 2000 mm/s²

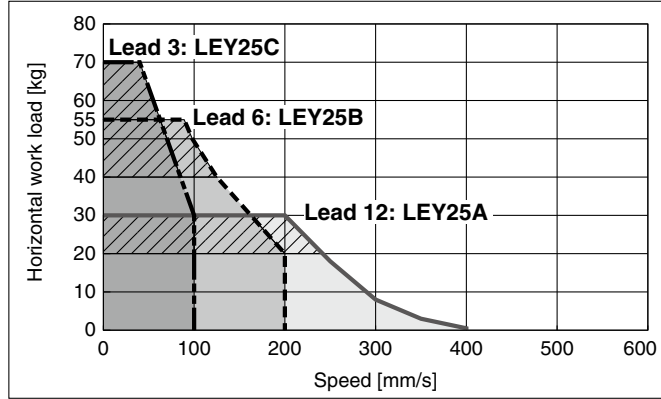

Vertical

LEY25□E-X8

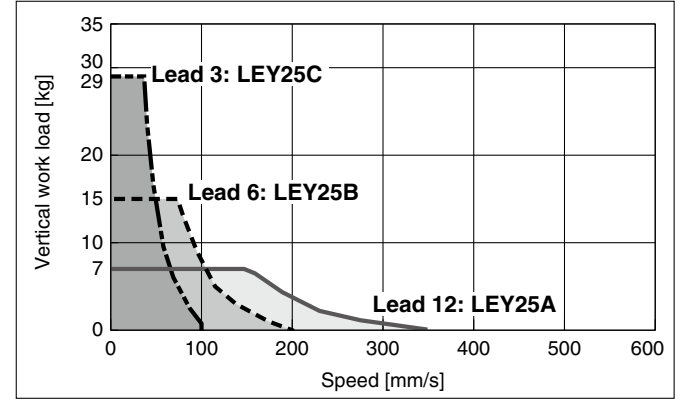

LEY32□E-X8 ▨ for acceleration/deceleration: 2000 mm/s²

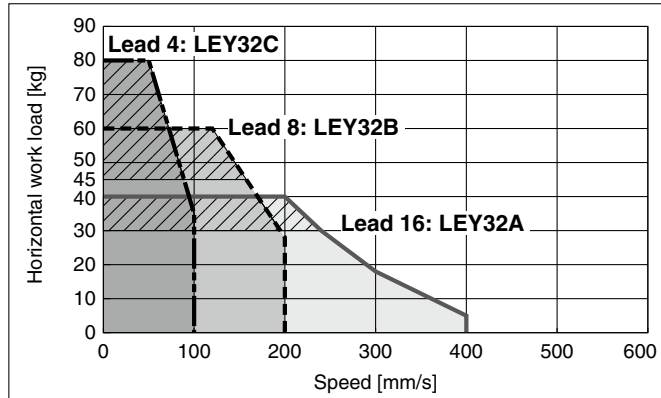

LEY32□E-X8

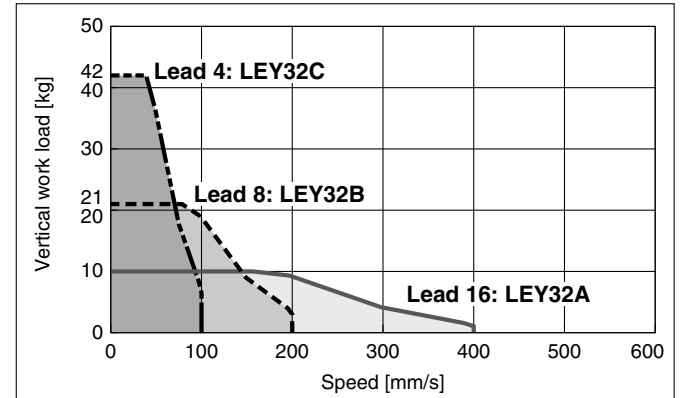

LEY40□E-X8 ▨ for acceleration/deceleration: 2000 mm/s²

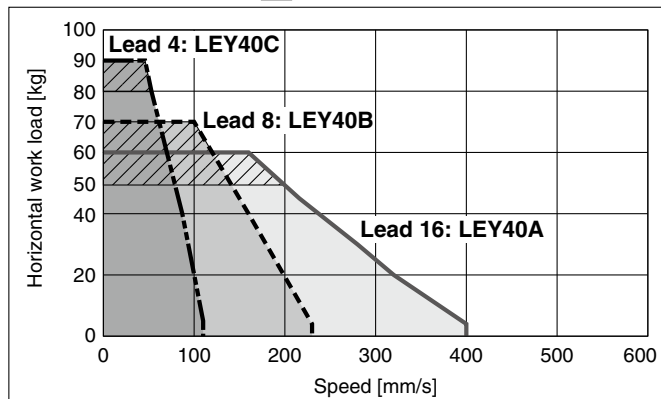

LEY40□E-X8

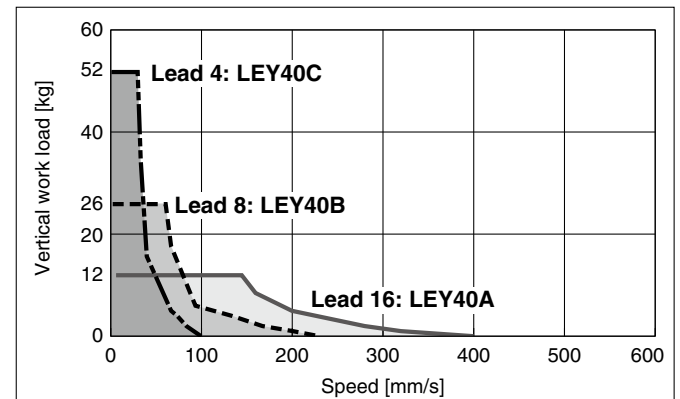

Items not listed are the same as those of the standard product. For details, refer to page 421.

Force Conversion Graph (Guide)

Battery-less Absolute (Step Motor 24 VDC)

LEY25□E-X8

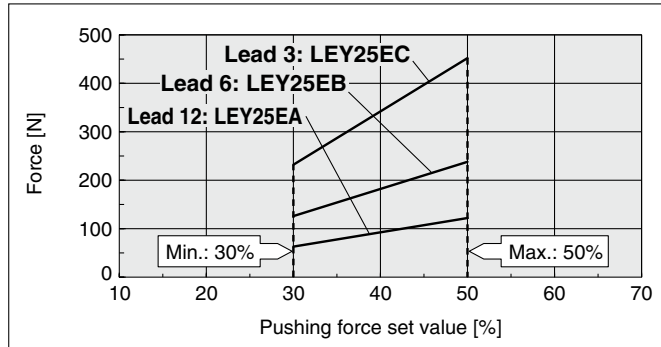

Ambient temperature	Pushing force set value [%]	Duty ratio [%]	Continuous pushing time [min]
40°C or less	50 or less	100	No restriction

LEY32□E-X8

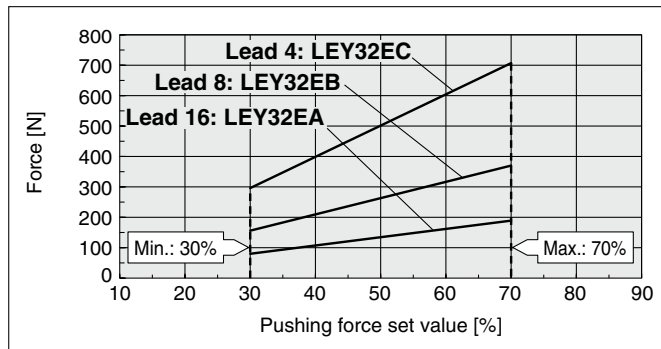

Ambient temperature	Pushing force set value [%]	Duty ratio [%]	Continuous pushing time [min]
40°C or less	70 or less	100	No restriction

LEY40□E-X8

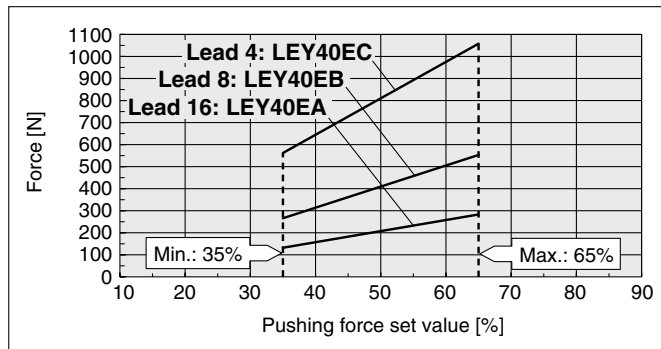

Ambient temperature	Pushing force set value [%]	Duty ratio [%]	Continuous pushing time [min]
40°C or less	65 or less	100	No restriction

<Limit Values for Pushing Force and Trigger Level in Relation to Pushing Speed> Without Load

Model	Lead	Pushing speed [mm/s]	Pushing force (Setting input value)
LEY25□E	A/B/C	21 to 35	40 to 50%
LEY32□E	A	24 to 30	50 to 70%
	B/C	21 to 30	
LEY40□E	A	24 to 30	50 to 65%
	B/C	21 to 30	

There is a limit to the pushing force in relation to the pushing speed. If the product is operated outside of the range (low pushing force), the completion signal [INP] may be output before the pushing operation has been completed (during the moving operation).
If operating with the pushing speed below the min. speed, please check for operating problems before using the product.

<Set Values for Vertical Upward Transfer Pushing Operations>

For vertical loads (upward), set the pushing force to the max. value shown below and operate at the work load or less.

Model	LEY25□E			LEY32□E			LEY40□E		
	A	B	C	A	B	C	A	B	C
Work load [kg]	2.5	5	10	4.5	9	18	7	14	28
Pushing force	50%			70%			65%		

LEY-X8 Series

Battery-less Absolute (Step Motor 24 VDC)

Dust-tight/Water-jet-proof (IP65 Equivalent/IP67 Equivalent)

Graph of Allowable Lateral Load on the Rod End (Guide)

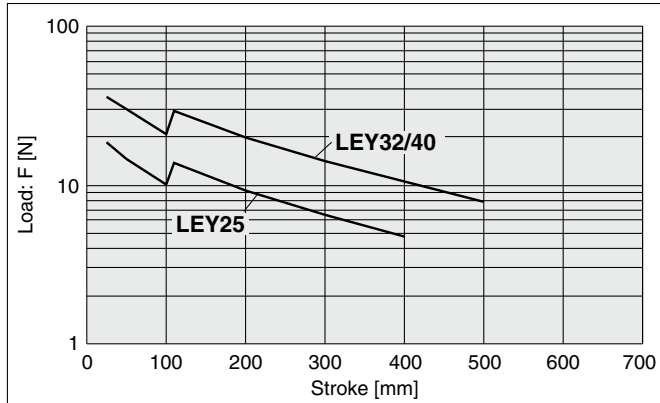

[Stroke] = [Product stroke] + [Distance from the rod end to the center of gravity of the workpiece]

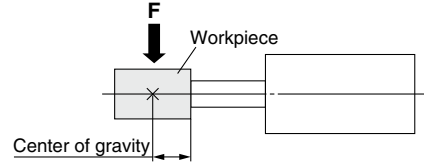

* The changes in the graph waveforms are due to the difference in components of different product strokes.

Rod Displacement: δ [mm]

Stroke \ Size	30	50	100	150	200	250	300	350	400	450	500
25	±0.3	±0.4	±0.7	±0.7	±0.9	±1.1	±1.3	±1.5	±1.7	—	—
32/40	±0.3	±0.4	±0.7	±0.6	±0.8	±1.0	±1.1	±1.3	±1.5	±1.7	±1.8

* The values without a load are shown.

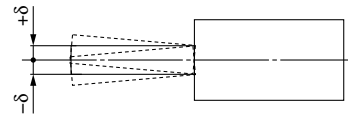

Non-rotating Accuracy of Rod

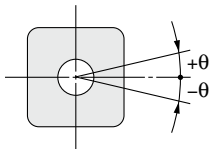

Size	Non-rotating accuracy θ
25	±0.8°
32/40	±0.7°

* Avoid using the electric actuator in such a way that rotational torque would be applied to the piston rod.

This may cause the deformation of the non-rotating guide, abnormal auto switch responses, play in the internal guide, or an increase in the sliding resistance.

Battery-less Absolute (Step Motor 24 VDC)

Rod Type

Dust-tight/Water-jet-proof (IP65 Equivalent/IP67 Equivalent)



* For details, refer to page 1343 and onward.

LEY-X8 (Made to Order) Series LEY25, 32, 40



Refer to pages 883 to 885 for model selection.

How to Order

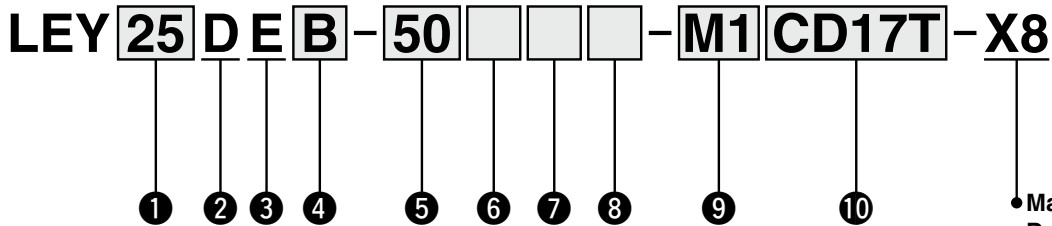
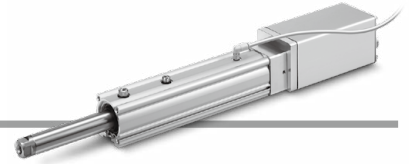

● Made to order: Dust-tight/Water-jet-proof
For details on controllers, refer to page 888.

1 Size

25
32/40

2 Motor mounting position

D	In-line
---	---------

3 Motor type

E	Battery-less absolute (Step motor 24 VDC)
---	---

4 Lead [mm]

Symbol	LEY25	LEY32/40
A	12	16
B	6	8
C	3	4

5 Stroke [mm]

30	30
to	to
500	500

* For details, refer to the applicable stroke table below.

6 Motor option

Nil	Without option
B	With lock

7 Rod end thread

Nil	Rod end female thread
M	Rod end male thread (1 rod end nut is included.)

8 Mounting*2

Symbol	Type	Motor mounting position
		In-line
Nil	Ends tapped/ Body bottom tapped*3	●
F	Rod flange*3	●

9 Actuator cable type/length

Robotic cable				[m]
MN	None	M8	8*4	
M1	1.5	MA	10*4	
M3	3	MB	15*4	
M5	5	MC	20*4	

Applicable Stroke Table*1

●: Standard

Model	Stroke [mm]	30	50	100	150	200	250	300	350	400	450	500	Manufacturable stroke range
LEY25		●	●	●	●	●	●	●	●	●	—	—	30 to 400
LEY32/40		●	●	●	●	●	●	●	●	●	●	●	30 to 500

* For auto switches, refer to page 894.

* "-X8" is not added to an actuator model with a controller part number suffix. Example) "LEY25DEB-100" for the LEY25DEB-100M-M1CD17T-X8

10 Controller

Nil	Without controller
C□1□□	With controller

C D 1 7 T

Interface (Communication protocol/Input/Output)

Symbol	Type	Number of axes, Special specification	
		Standard	With STO sub-function
5	Parallel input (NPN)	●	
6	Parallel input (PNP)	●	
E	EtherCAT	●	●
9	EtherNet/IP™	●	●
P	PROFINET	●	●
D	DeviceNet®	●	
L	IO-Link	●	●
M	CC-Link	●	

Mounting

7	Screw mounting
8*5	DIN rail

Number of axes, Special specification

Symbol	Number of axes	Specification
1	Single axis	Standard
F	Single axis	With STO sub-function

Communication plug connector, I/O cable*6

Symbol	Type	Applicable interface
Nil	Without accessory	—
S	Straight type communication plug connector	DeviceNet® CC-Link Ver. 1.10
T	T-branch type communication plug connector	
1	I/O cable (1.5 m)	Parallel input (NPN) Parallel input (PNP)
3	I/O cable (3 m)	
5	I/O cable (5 m)	

- *1 Please contact SMC for non-standard strokes as they are produced as special orders.
- *2 The mounting bracket is shipped together with the product but does not come assembled.
- *3 For the horizontal cantilever mounting of the rod flange, or ends tapped types, use the actuator within the following stroke range.
 - LEY25: 200 or less
 - LEY32/40: 100 or less

- *4 Produced upon receipt of order
- *5 The DIN rail is not included. It must be ordered separately.
- *6 Select "Nil" for anything other than DeviceNet®, CC-Link, or parallel input.
 - Select "Nil," "S," or "T" for DeviceNet® or CC-Link.
 - Select "Nil," "1," "3," or "5" for parallel input.

⚠ Caution

[CE/UKCA-compliant products]

EMC compliance was tested by combining the electric actuator LEY series and the controller JXC series. The EMC depends on the configuration of the customer's control panel and the relationship with other electrical equipment and wiring. Therefore, compliance with the EMC directive cannot be certified for SMC components incorporated into the customer's equipment under actual operating conditions. As a result, it is necessary for the customer to verify compliance with the EMC directive for the machinery and equipment as a whole.

[Precautions relating to differences in controller versions]

When the JXC series is to be used in combination with the battery-less absolute encoder, use a controller that is version V3.4 or S3.4 or higher. For details, refer to pages 1077 and 1078.

The actuator and controller are sold as a package.

Confirm that the combination of the controller and actuator is correct.

<Check the following before use.>

- *1 Check the actuator label for the model number. This number should match that of the controller.

LEY25DEB-100

*1



* Refer to the Operation Manual for using the products. Please download it via our website:
<https://www.smcworld.com>

Type	Step data input type	EtherCAT direct input type	EtherCAT direct input type with STO sub-function	EtherNet/IP™ direct input type	EtherNet/IP™ direct input type with STO sub-function	PROFINET direct input type	PROFINET direct input type with STO sub-function	DeviceNet® direct input type	IO-Link direct input type	IO-Link direct input type with STO sub-function	CC-Link direct input type
Series	JXC51 JXC61	JXCE1	JXCEF	JXC91	JXC9F	JXCP1	JXCPF	JXCD1	JXCL1	JXCLF	JXCM1
Features	Parallel I/O	EtherCAT direct input	EtherCAT direct input with STO sub-function	EtherNet/IP™ direct input	EtherNet/IP™ direct input with STO sub-function	PROFINET direct input	PROFINET direct input with STO sub-function	DeviceNet® direct input	IO-Link direct input	IO-Link direct input with STO sub-function	CC-Link direct input
Compatible motor	Battery-less absolute (Step motor 24 VDC)										
Max. number of step data	64 points										
Power supply voltage	24 VDC										
Reference page	1017					1063					

LEY-X8 Series

Battery-less Absolute (Step Motor 24 VDC)

Dust-tight/Water-jet-proof (IP65 Equivalent/IP67 Equivalent)

Specifications

Step Motor (Servo/24 VDC)

Model		LEY25□E-X8			LEY32□E-X8			LEY40□E-X8				
Work load [kg]*1	Horizontal	(3000 [mm/s ²])	20	40	60	30	45	60	50	60	80	
	Vertical	(2000 [mm/s ²])	30	55	70	40	60	80	60	70	90	
		(3000 [mm/s ²])	7	15	29	10	21	42	12	26	52	
Pushing force [N]*2 *3 *4			63 to 122	126 to 238	232 to 452	80 to 189	156 to 370	296 to 707	132 to 283	266 to 553	562 to 1058	
Speed [mm/s]*4			18 to 400	9 to 200	5 to 100	24 to 400	12 to 200	6 to 100	24 to 400	12 to 230	6 to 110	
Max. acceleration/deceleration [mm/s ²]			3000									
Pushing speed [mm/s]*5			35 or less			30 or less			30 or less			
Positioning repeatability [mm]			±0.02									
Lost motion [mm]*6			0.1 or less									
Screw lead [mm]			12	6	3	16	8	4	16	8	4	
Impact/Vibration resistance [m/s ²]*7			50/20									
Actuation type			Ball screw (LEY□D)									
Guide type			Sliding bushing (Piston rod)									
Enclosure*8			IP65 equivalent/IP67 equivalent*12									
Operating temperature range [°C]			5 to 40									
Operating humidity range [%RH]			90 or less (No condensation)									
Electric specifications	Motor size			□42			□56.4			□56.4		
	Motor type			Battery-less absolute (Step motor 24 VDC)								
	Encoder			Battery-less absolute								
	Power supply voltage [V]			24 VDC ±10%								
	Power [W]*9 *11			Max. power 48			Max. power 104			Max. power 106		
Lock unit specifications	Type*10			Non-magnetizing lock								
	Holding force [N]			78	157	294	108	216	421	127	265	519
	Power [W]*11			5			5			5		
	Rated voltage [V]			24 VDC ±10%								

*1 Horizontal: The maximum value of the work load. An external guide is necessary to support the load. (Friction coefficient of guide: 0.1 or less) The actual work load and transfer speed change according to the condition of the external guide. Also, speed changes according to the work load. Check the "Model Selection" on page 883.

Vertical : Speed changes according to the work load. Check the "Model Selection" on page 883.

The values shown in () are the acceleration/deceleration. Set these values to be 3000 [mm/s²] or less.

*2 Pushing force accuracy is ±20% (F.S.).

*3 The pushing force values for LEY25□E are 30% to 50%, for LEY32□E are 30% to 70%, and for LEY40□E are 35% to 65%.

The pushing force values change according to the duty ratio and pushing speed. Check the "Model Selection" on page 884.

*4 The speed and force may change depending on the cable length, load, and mounting conditions. Furthermore, if the cable length exceeds 5 m, then it will decrease by up to 10% for each 5 m. (At 15 m: Reduced by up to 20%)

*5 The allowable speed for pushing operations. When push conveying a workpiece, operate at the vertical work load or less.

*6 A reference value for correcting errors in reciprocal operation

*7 Impact resistance : No malfunction occurred when the actuator was tested with a drop tester in both an axial direction and a perpendicular direction to the lead screw. (The test was performed with the actuator in the initial state.)

Vibration resistance: No malfunction occurred in a test ranging between 45 to 2000 Hz. The test was performed in both an axial direction and a perpendicular direction to the lead screw. (The test was performed with the actuator in the initial state.)

*8 Cannot be used in an environment where oil such as cutting oil splashes or it is constantly exposed to water

Take appropriate protective measures. For details on enclosure, refer to the "Enclosure" on page 881.

*9 Indicates the max. power during operation (including the controller)

This value can be used for the selection of the power supply.

*10 With lock only

*11 For an actuator with lock, add the power for the lock.

*12 Excludes the controller body and the connector part on the controller side

Weight

Weight: In-line Motor Type

LEY25D									
Stroke	30	50	100	150	200	250	300	350	400
Product weight [kg]	1.48	1.55	1.72	1.97	2.15	2.32	2.50	2.67	2.85

LEY32D											
Stroke	30	50	100	150	200	250	300	350	400	450	500
Product weight [kg]	2.58	2.69	2.98	3.36	3.65	3.94	4.22	4.51	4.80	5.08	5.37

LEY40D											
Stroke	30	50	100	150	200	250	300	350	400	450	500
Product weight [kg]	2.93	3.04	3.33	3.71	4.00	4.29	4.57	4.86	5.15	5.43	5.72

Additional Weight

[kg]

Size		25	32	40
Lock		0.35	0.65	0.65
Rod end male thread	Male thread	0.03	0.03	0.03
	Nut	0.02	0.02	0.02
Rod flange (including mounting bolt)		0.17	0.20	0.20

LEY-X8 Series

Battery-less Absolute (Step Motor 24 VDC)

Dust-tight/Water-jet-proof (IP65 Equivalent/IP67 Equivalent)

Construction

In-line motor type: LEY²⁵_{32D}
40

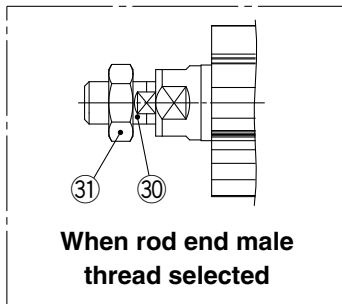
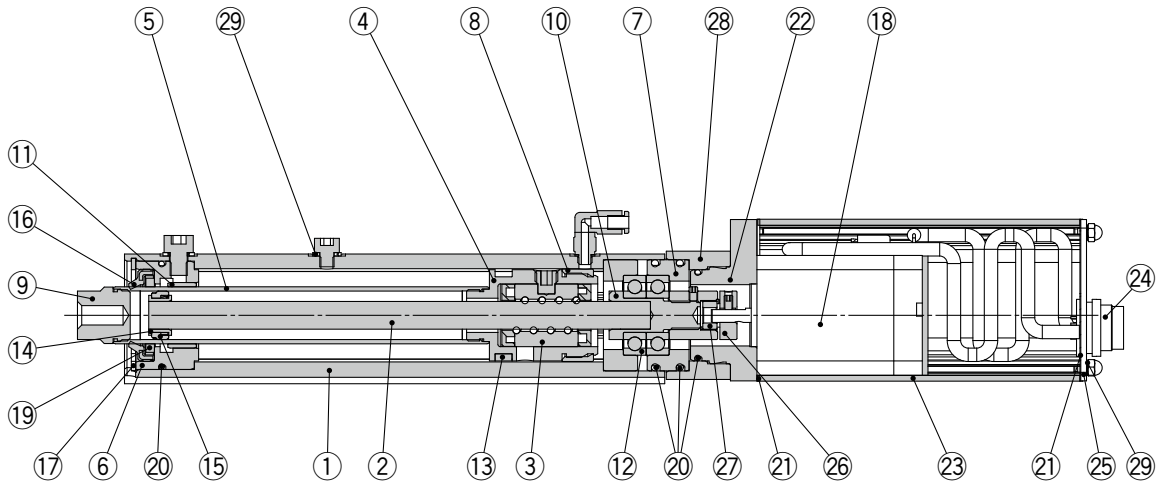

Component Parts

No.	Description	Material	Note
1	Body	Aluminum alloy	Anodized
2	Ball screw shaft	Alloy steel	
3	Ball screw nut	Synthetic resin/Alloy steel	
4	Piston	Aluminum alloy	
5	Piston rod	Stainless steel	Hard chrome plating
6	Rod cover	Aluminum alloy	Anodized
7	Bearing holder	Aluminum alloy	
8	Rotation stopper	Resin	
9	Socket	Stainless steel	
10	Connected shaft	Free cutting carbon steel	Nickel plating
11	Bushing	Bearing alloy	
12	Bearing	—	
13	Magnet	—	
14	Wear ring holder	Stainless steel	Stroke 101 mm or more
15	Wear ring	Resin	Stroke 101 mm or more
16	Greater water resistant scraper	Stainless steel/NBR	

No.	Description	Material	Note
17	Retaining ring	Stainless steel	
18	Motor	—	
19	Lube-retainer	Felt	
20	O-ring	NBR	
21	Gasket	Chloroprene	
22	Motor adapter	Aluminum alloy	LEY25 only
23	Motor cover	Aluminum alloy	Anodized
24	Metal connector	Zinc die-casted	Chrome plating
25	End cover	Aluminum alloy	Anodized
26	Hub	Aluminum alloy	
27	Spider	NBR	
28	Motor block	Aluminum alloy	Anodized
29	Seal washer	Stainless steel/NBR	
30	Socket (Male thread)	Stainless steel	
31	Nut	Stainless steel	

Replacement Parts/Grease Pack

Applied portion	Order no.
Piston rod	GR-S-010 (10 g) GR-S-020 (20 g)

* Apply grease on the piston rod periodically.
Grease should be applied at 1 million cycles or 200 km, whichever comes first.

Dimensions

In-line motor type

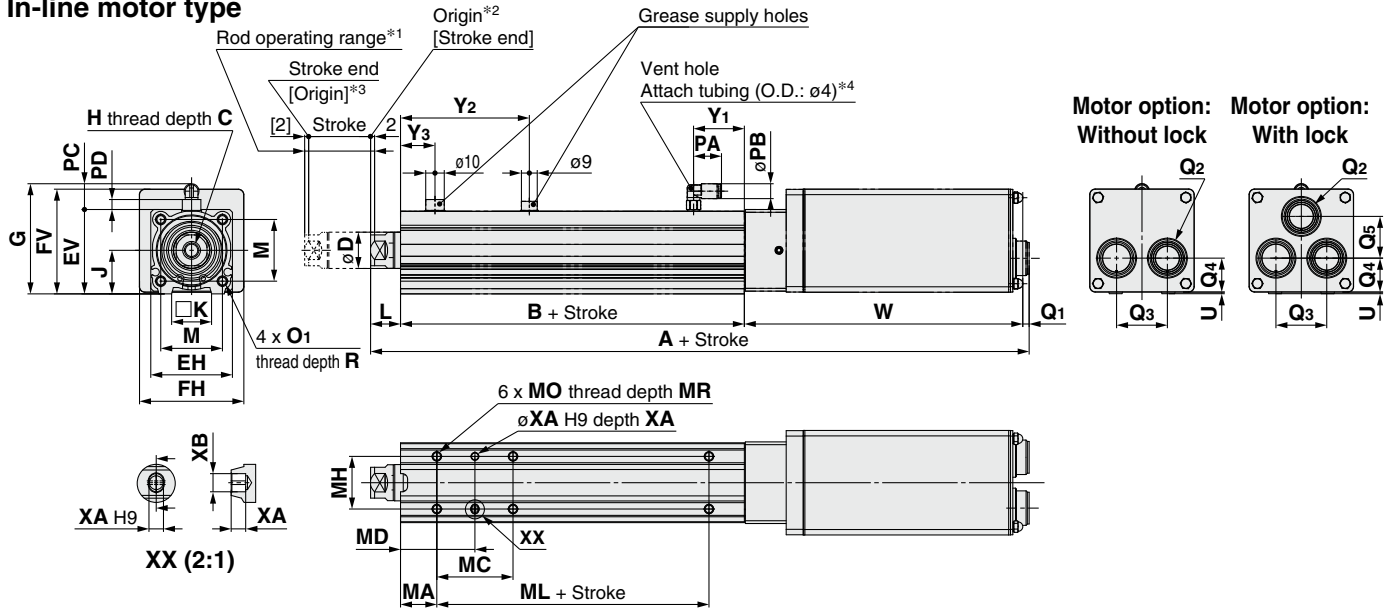

25
Rod end male thread: LEY32D□-□□M
40

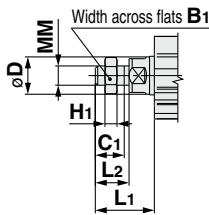

Size	B ₁	C ₁	D	H ₁	L ₁	L ₂	MM
25	22	20.5	20	8	38	23.5	M14 x 1.5
32/40	22	20.5	25	8	42	23.5	M14 x 1.5

* The L₁ measurement is when the unit is in the original position. At this position, 2 mm at the end.

Size	Stroke range [mm]	A		B	C	D	EH	EV	FH	FV	G	H	J	K	L	M	O ₁	R
		Without lock	With lock															
25	30 to 100	262.5	312.5	89.5	13	20	44	45.5	57.6	57.7	61.4	M8 x 1.25	24	17	14.5	34	M5 x 0.8	8
	105 to 400	287.5	337.5															
32	30 to 100	273	323	96	13	25	51	56.5	69.6	79.6	72.4	M8 x 1.25	31	22	18.5	40	M6 x 1.0	10
	105 to 500	303	353															
40	30 to 100	295	355	96	13	25	51	56.5	69.6	79.6	72.4	M8 x 1.25	31	22	18.5	40	M6 x 1.0	10
	105 to 500	325	375															

Size	Stroke range [mm]	PA	PB	PC	PD	Q ₁	Q ₂		Q ₃	Q ₄	Q ₅		U	W		Y ₁	Y ₂	Y ₃
							Without lock	With lock			Without lock	With lock		Without lock	With lock			
25	30 to 100	15.4	8.2	15.9	6.5	3.5	2 x ø22	3 x ø22	28	18.7	—	23	0.9	155	205	28	71	19
	105 to 400																96	
32	30 to 100	15.4	8.2	15.9	7.1	3.5	2 x ø22	3 x ø22	36	28	—	32	1	155	205	30	75.5	16
	105 to 500																105.5	
40	30 to 100	15.4	8.2	15.9	7.1	3.5	2 x ø22	3 x ø22	36	28	—	32	1	177	227	30	75.5	16
	105 to 500																105.5	

Body Bottom Tapped

Size	Stroke range [mm]	MA	MC	MD	MH	ML	MO	MR	XA	XB
25	30 to 39	20	24	32	29	50	M5 x 0.8	6.5	4	5
	40 to 100		42	41		75				
	101 to 124		59	49.5						
	125 to 200		76	58						
	201 to 400									
32/40	30 to 39	25	22	36	30	50	M6 x 1	8.5	5	6
	40 to 100		36	43		80				
	101 to 124		53	51.5						
	125 to 200		70	60						
	201 to 500									

*1 This is the range within which the rod can move when it returns to origin. Make sure that workpieces mounted on the rod do not interfere with other workpieces or the facilities around the rod.

*2 Position after returning to origin

*3 [] for when the direction of return to origin has changed

*4 The vent hole is the port for releasing to atmosphere. Do not apply pressure to this hole.

Attach tubing to the vent hole and place the end of the tubing so it is not exposed to dust or water.

* The direction of rod end width across flats (□K) differs depending on the products.

For the mounting bracket dimensions, refer to the **Web Catalog**.

LEY-X8 Series

Battery-less Absolute (Step Motor 24 VDC)

Dust-tight/Water-jet-proof (IP65 Equivalent/IP67 Equivalent)

Option: Actuator Cable

[Metal connector robotic cable for battery-less absolute (Step motor 24 VDC)]

LE-CE-1-X4

Cable length (L) [m]

1	1.5
3	3
5	5
8	8*1
A	10*1
B	15*1
C	20*1

*1 Produced upon receipt of order

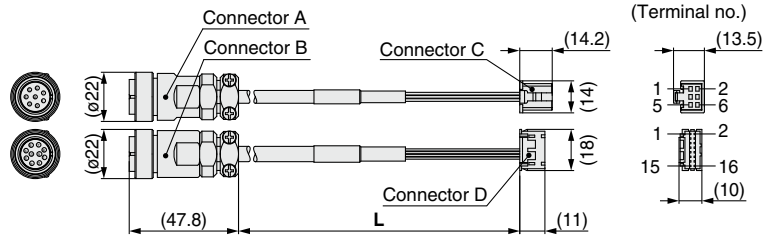

Weight

Product no.	Weight [g]	Note
LE-CE-1-X4	270	Robotic cable
LE-CE-3-X4	440	
LE-CE-5-X4	650	
LE-CE-8-X4	980	
LE-CE-A-X4	1200	
LE-CE-B-X4	1760	
LE-CE-C-X4	2290	

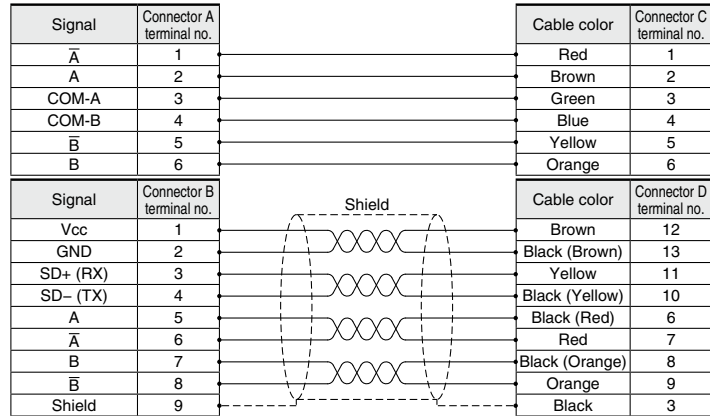

[Metal connector robotic cable with lock for battery-less absolute (Step motor 24 VDC)]

LE-CE-1-B-X4

Cable length (L) [m]

1	1.5
3	3
5	5
8	8*2
A	10*2
B	15*2
C	20*2

*2 Produced upon receipt of order

With lock and sensor

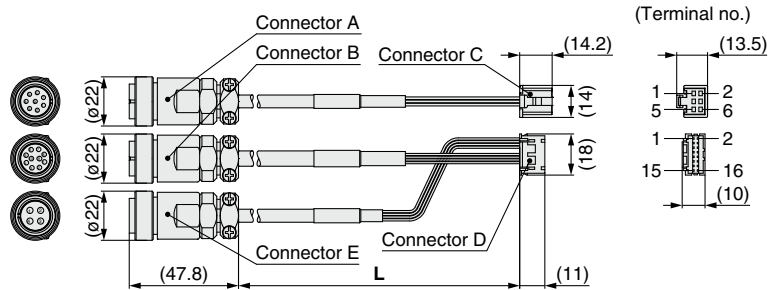

Weight

Product no.	Weight [g]	Note
LE-CE-1-B-X4	320	Robotic cable
LE-CE-3-B-X4	490	
LE-CE-5-B-X4	700	
LE-CE-8-B-X4	1030	
LE-CE-A-B-X4	1250	
LE-CE-B-B-X4	1810	
LE-CE-C-B-X4	2340	

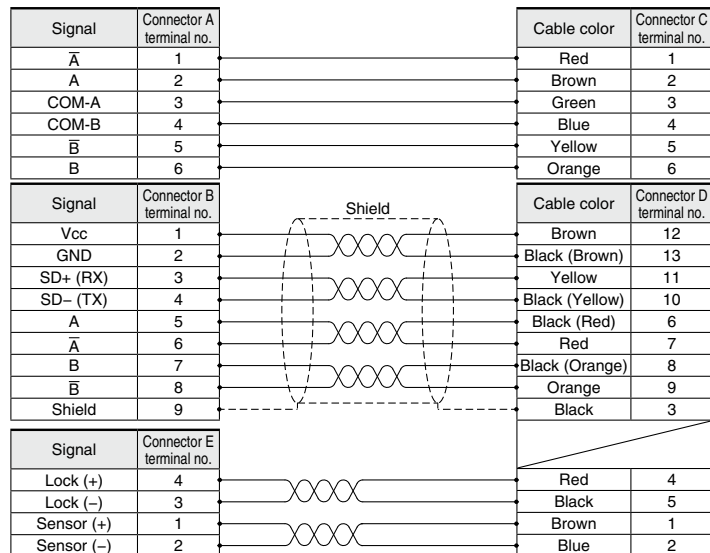

LEY-X8 Series Auto Switch Mounting

Auto Switch Proper Mounting Position

Applicable auto switch: D-M9□A(V)

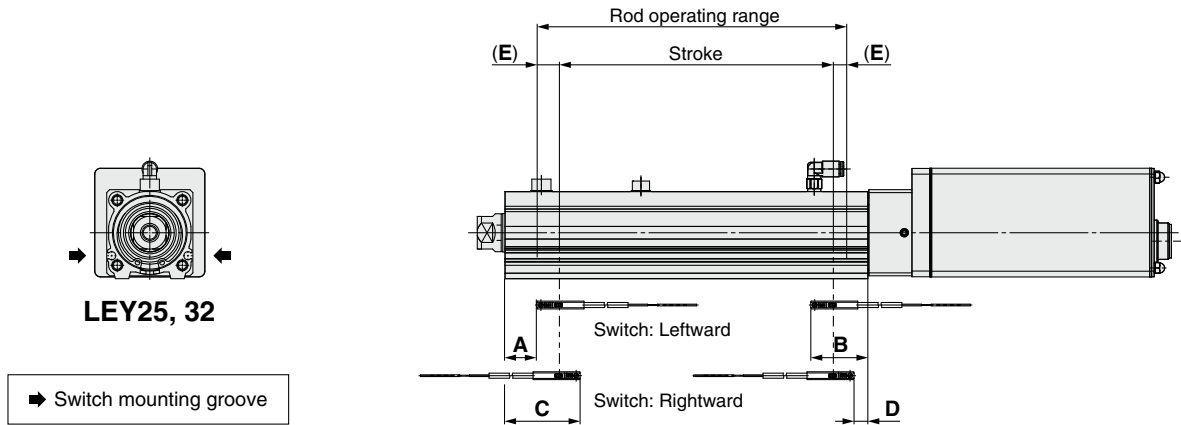

Size	Stroke range	Auto switch position				Return to origin distance	Operating range
		Leftward mounting		Rightward mounting			
		A	B	C	D		
25	15 to 100	27	62.5	39	50.5	(2)	4.2
	105 to 400	52		64			
32/40	20 to 100	30.5	85.5	42.5	53.5	(2)	4.9
	105 to 500	90.5		102.5			

* The values in the table above are to be used as a reference when mounting auto switches for stroke end detection. Adjust the auto switch after confirming the operating conditions in the actual setting.

* Since the operating range is provided as a guideline including hysteresis, it cannot be guaranteed (assuming approx. $\pm 30\%$ dispersion). It may change substantially depending on the ambient environment.

Auto Switch Mounting

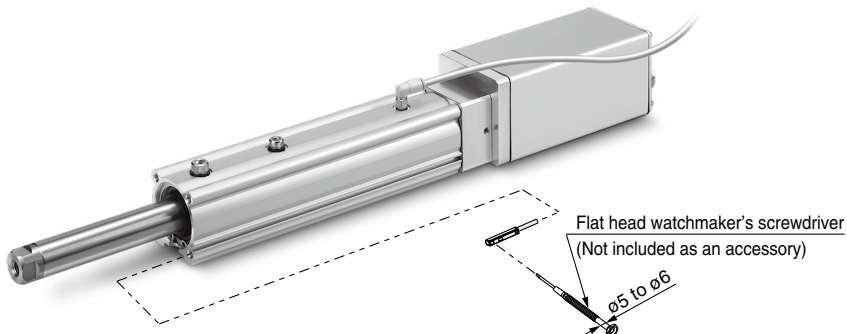

Tightening Torque for Auto Switch Mounting Screw [N·m]

Auto switch model	Tightening torque
D-M9□A(V)	0.05 to 0.10

* When tightening the auto switch mounting screw (included with the auto switch), use a watchmaker's screwdriver with a handle diameter of 5 to 6 mm.

Water Resistant 2-Color Indicator Solid State Auto Switch: Direct Mounting Type D-M9NA(V)/D-M9PA(V)/D-M9BA(V)

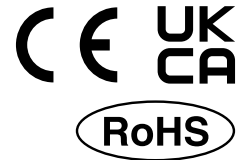

Grommet

- Water (coolant) resistant type
- 2-wire load current is reduced (2.5 to 40 mA).
- The proper operating range can be determined by the color of the light. (Red → Green ← Red)
- Using flexible cable as standard spec.

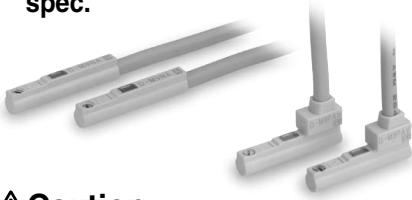

Caution

Precautions

Fix the auto switch with the existing screw installed on the auto switch body. The auto switch may be damaged if a screw other than the one supplied is used. Please contact SMC if using coolant liquid other than water based solution.

Weight

[g]

Auto switch model	D-M9NA(V)	D-M9PA(V)	D-M9BA(V)
Lead wire length			
0.5 m (Nil)	8	7	
1 m (M)	14	13	
3 m (L)	41	38	
5 m (Z)	68	63	

Dimensions

[mm]

D-M9□A

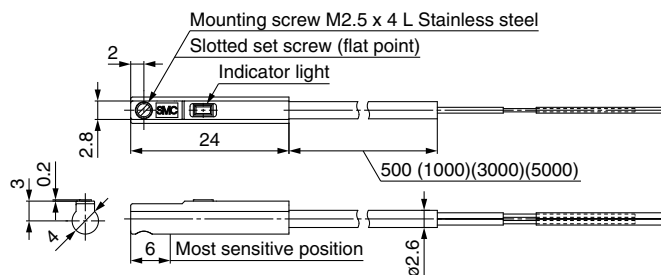

D-M9□AV

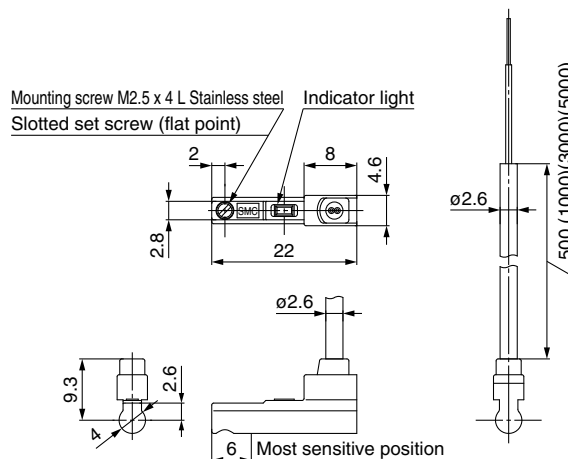

Auto Switch Specifications

PLC: Programmable Logic Controller

D-M9□A, D-M9□AV (With indicator light)						
Auto switch model	D-M9NA	D-M9NAV	D-M9PA	D-M9PAV	D-M9BA	D-M9BAV
Electrical entry direction	In-line	Perpendicular	In-line	Perpendicular	In-line	Perpendicular
Wiring type	3-wire				2-wire	
Output type	NPN		PNP		—	
Applicable load	IC circuit, Relay, PLC				24 VDC relay, PLC	
Power supply voltage	5, 12, 24 VDC (4.5 to 28 V)				—	
Current consumption	10 mA or less				—	
Load voltage	28 VDC or less		—		24 VDC (10 to 28 VDC)	
Load current	40 mA or less				2.5 to 40 mA	
Internal voltage drop	0.8 V or less at 10 mA (2 V or less at 40 mA)				4 V or less	
Leakage current	100 µA or less at 24 VDC				0.8 mA or less	
Indicator light	Operating range Red LED illuminates. Proper operating range Green LED illuminates.					
Standard	CE/UKCA marking					

Oilproof Flexible Heavy-duty Lead Wire Specifications

Auto switch model		D-M9NA□	D-M9NAV□	D-M9PA□	D-M9PAV□	D-M9BA□	D-M9BAV□
Sheath	Outside diameter [mm]	ø2.6					
Insulator	Number of cores	3 cores (Brown/Blue/Black)				2 cores (Brown/Blue)	
	Outside diameter [mm]	ø0.88					
Conductor	Effective area [mm ²]	0.15					
	Strand diameter [mm]	ø0.05					
Min. bending radius [mm]		17					

* Refer to page 1363 for solid state auto switch common specifications.

* Refer to page 1363 for lead wire lengths.

Environment

Enclosure: IP65 equivalent/IP67 equivalent

LEY-X7 Series Size 25, 32, 40

Incremental (Step Motor 24 VDC)

Incremental ((Servo Motor 24 VDC)

p. 903

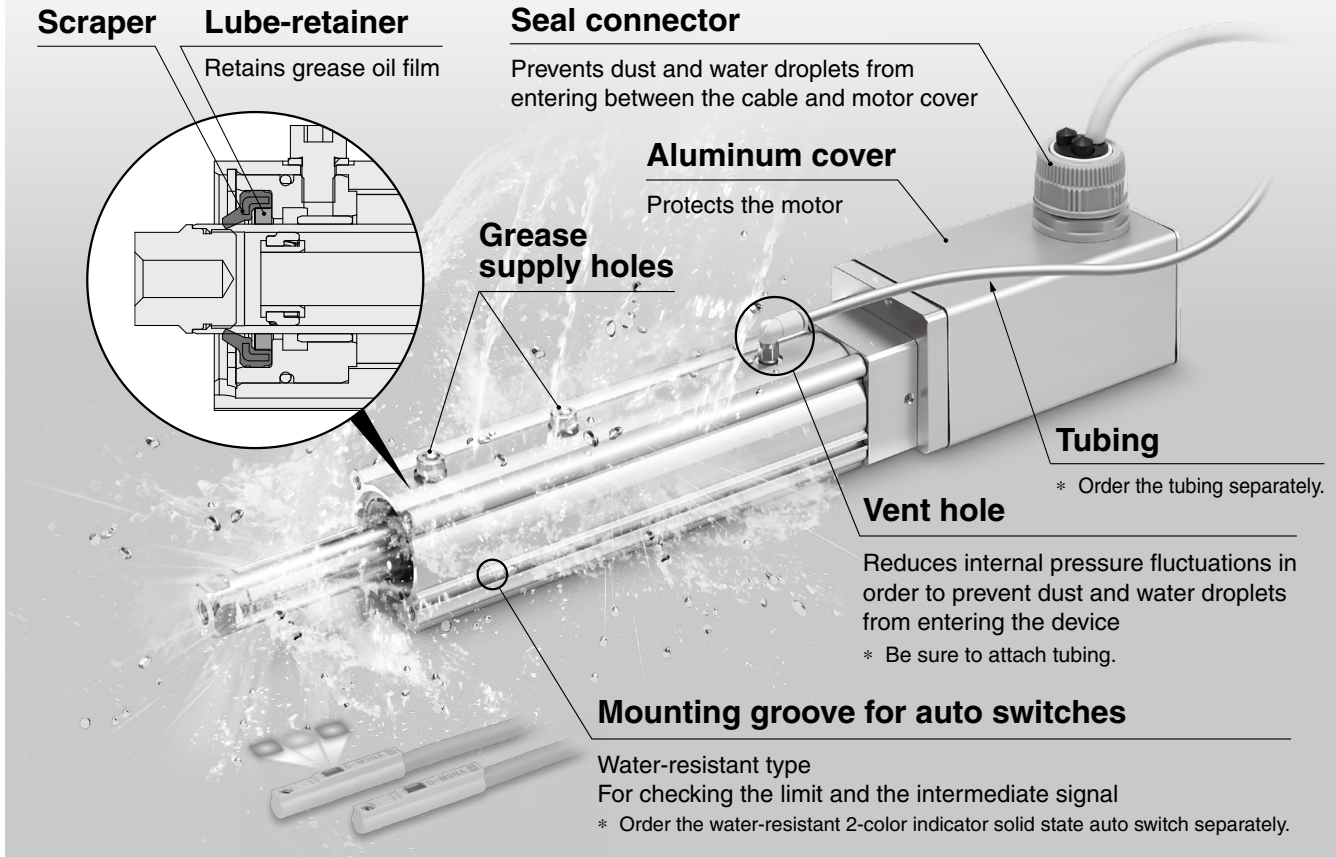

Max. stroke: 500 mm^{*1}

*1 For sizes 32 and 40

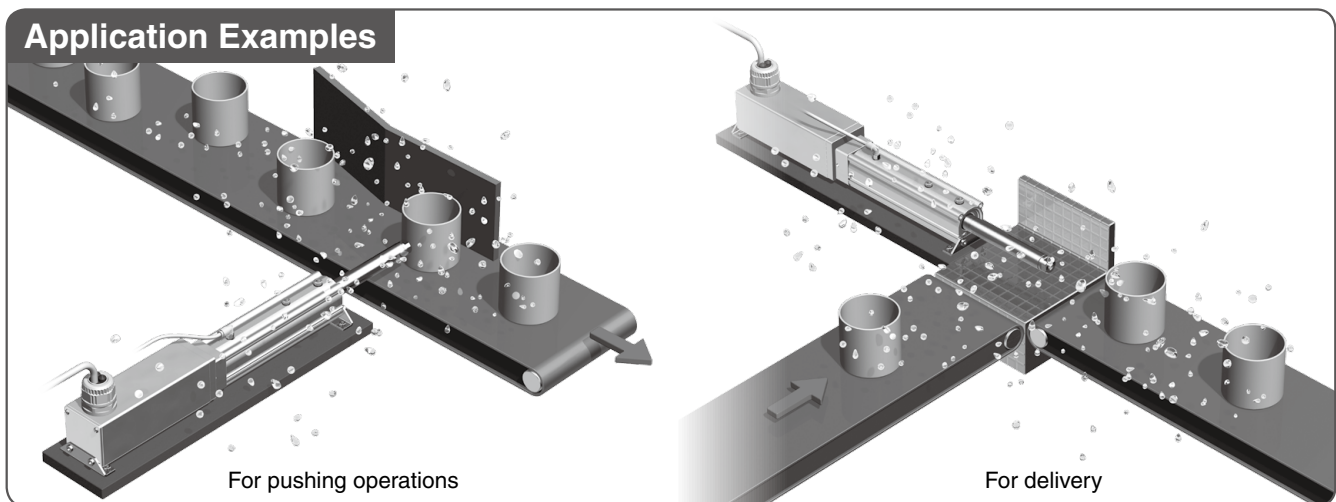

Rod Type

LEY-X7 Series Dust-tight/Water-jet-proof (IP65 Equivalent/IP67 Equivalent)

Model Selection

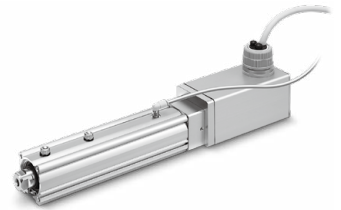

Refer to page 898 for the LECPA, JXC□₃² and page 899 for the LECA6.

LEY-X7 Series ▶ p. 903

Speed-Work Load Graph (Guide) For Step Motor (Servo/24 VDC) JXC□1, LECP1

Horizontal

LEY25□-X7 for acceleration/deceleration: 2000 mm/s²

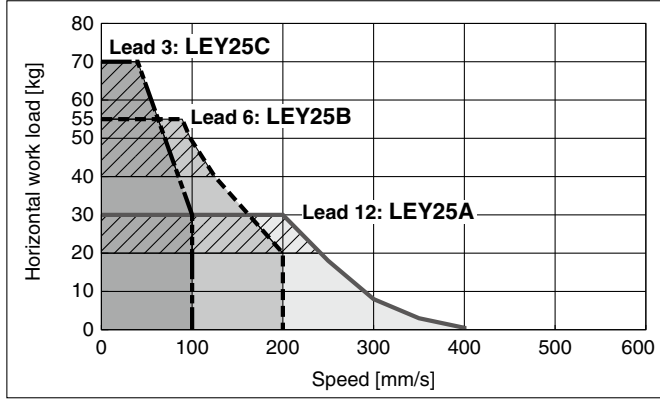

LEY32□-X7 for acceleration/deceleration: 2000 mm/s²

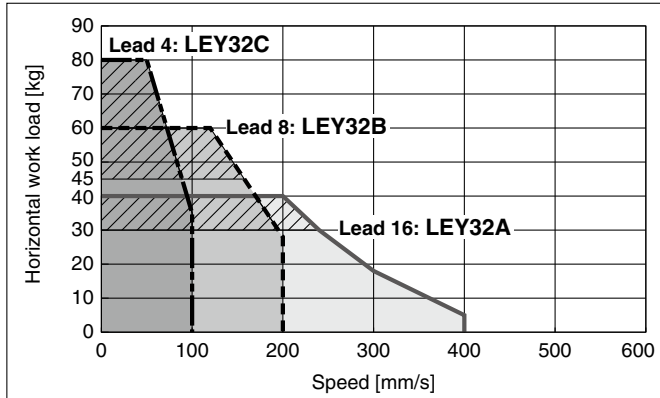

LEY40□-X7 for acceleration/deceleration: 2000 mm/s²

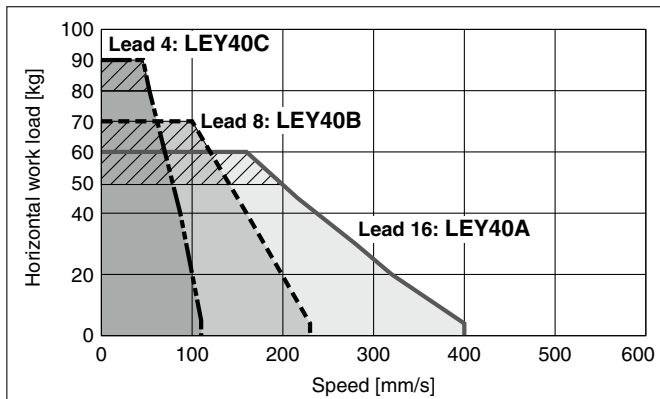

Vertical

LEY25□-X7

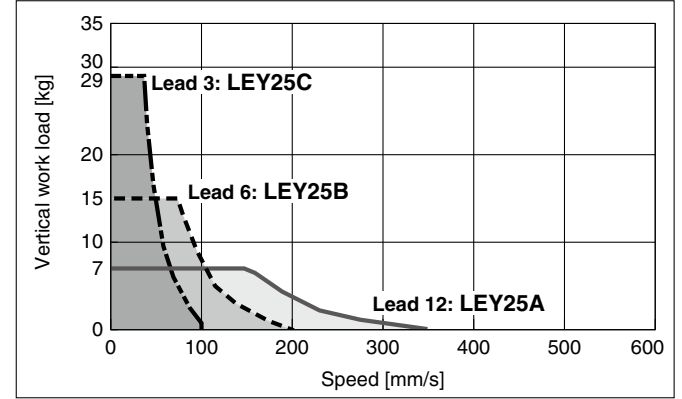

LEY32□-X7

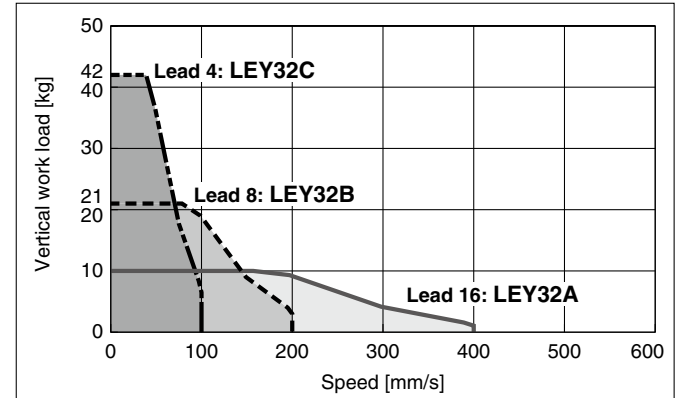

LEY40□-X7

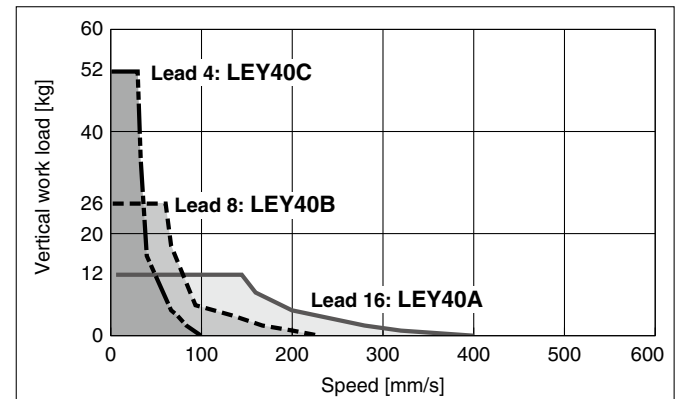

Refer to page 897 for the JXC□1, LEC□1 and page 899 for the LECA6.

Speed-Work Load Graph (Guide) For Step Motor (Servo/24 VDC) LEC□A, JXC□₃

Horizontal

LEY25□-X7

▨ for acceleration/deceleration: 2000 mm/s²

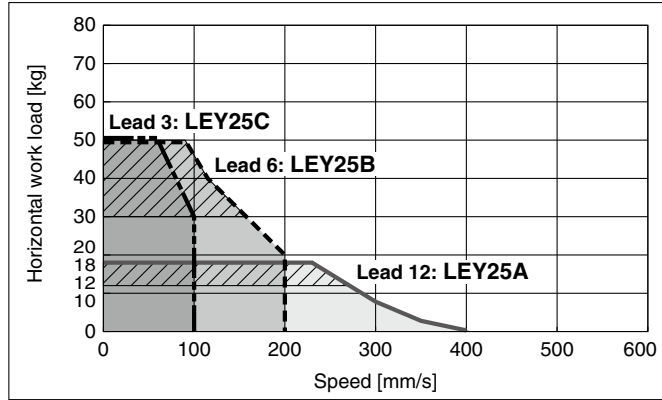

LEY32□-X7

▨ for acceleration/deceleration: 2000 mm/s²

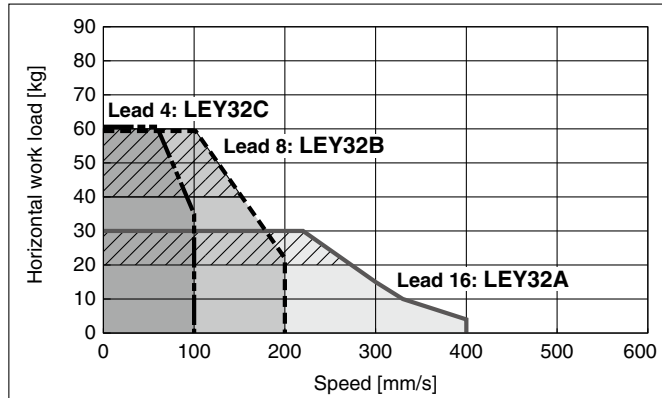

LEY40□-X7

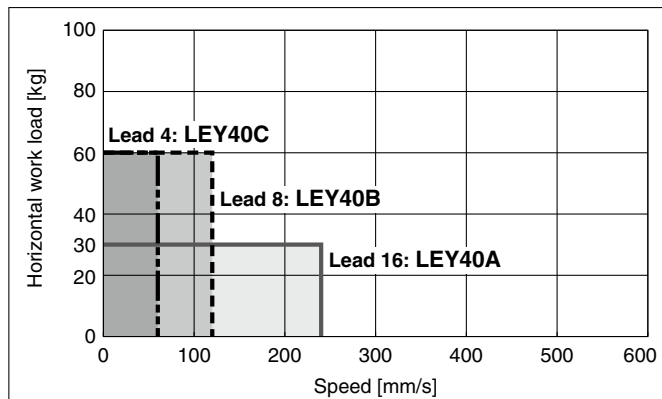

Vertical

LEY25□-X7

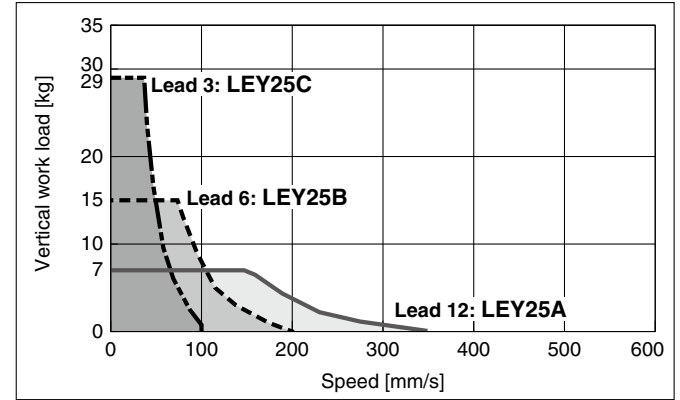

LEY32□-X7

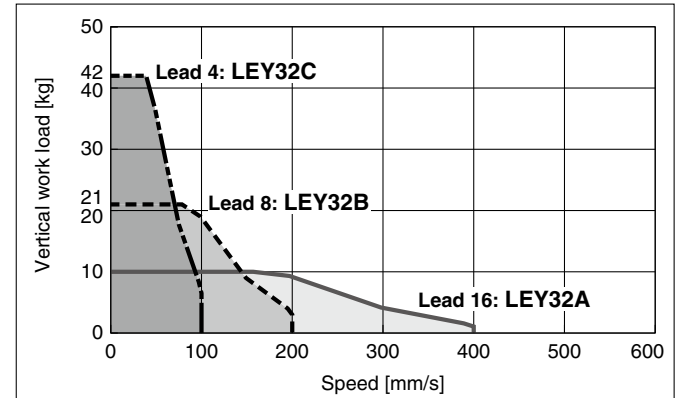

LEY40□-X7

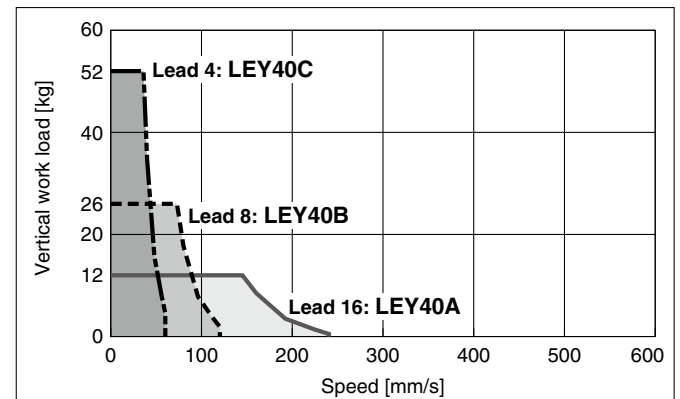

LEY-X7 Series

Incremental (Step Motor 24 VDC)

Incremental (Servo Motor 24 VDC)

Dust-tight/Water-jet-proof (IP65 Equivalent/IP67 Equivalent)

Refer to page 897 for the JXC□1, LEC□1 and page 898 for the LEC□2, JXC□3.

Speed-Work Load Graph (Guide) For Servo Motor (24 VDC) LECA6

Horizontal

LEY25□A-X7

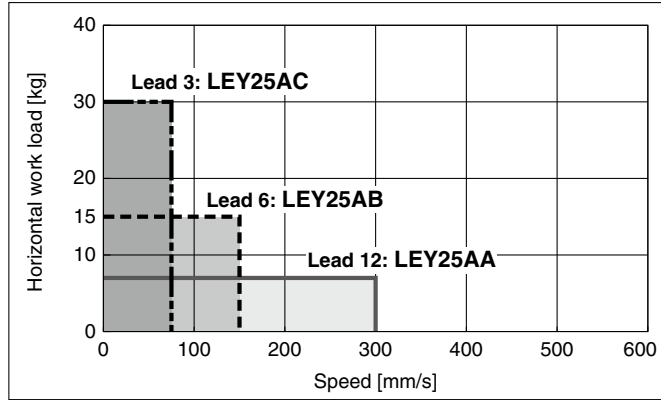

Vertical

LEY25□A-X7

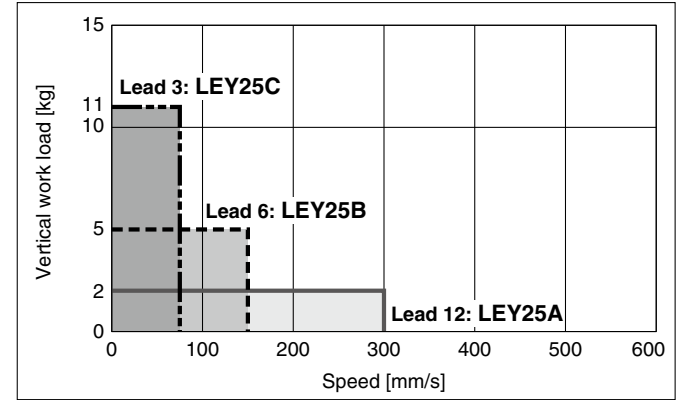

Force Conversion Graph

Step Motor (Servo/24 VDC)

LEY25□-X7

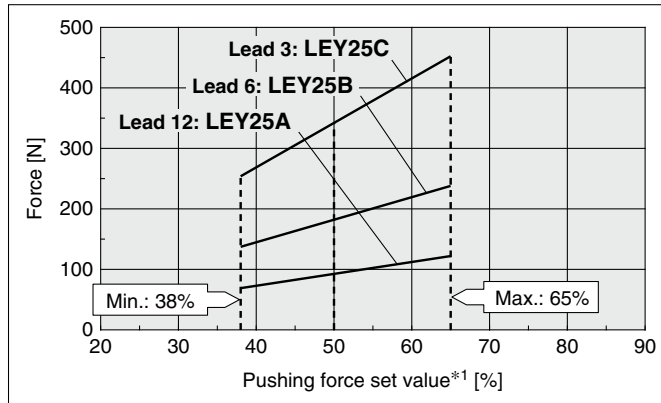

Ambient temperature	Pushing force set value*1 [%]	Duty ratio [%]	Continuous pushing time [min]
40°C or less	65 or less	100	No restriction

LEY32□-X7

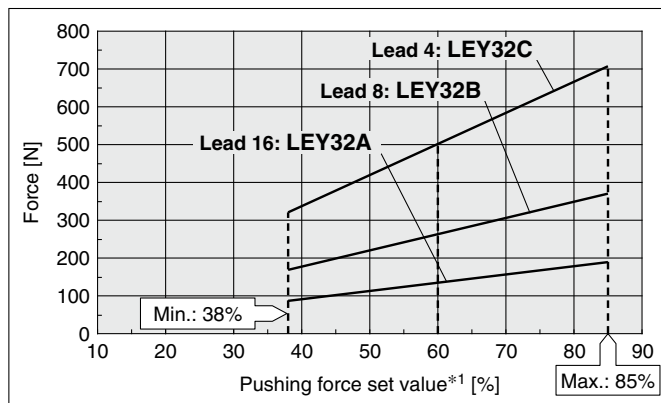

Ambient temperature	Pushing force set value*1 [%]	Duty ratio [%]	Continuous pushing time [min]
25°C or less	85 or less	100	No restriction
40°C	65 or less	100	No restriction
	85	50	15 or less

LEY40□-X7

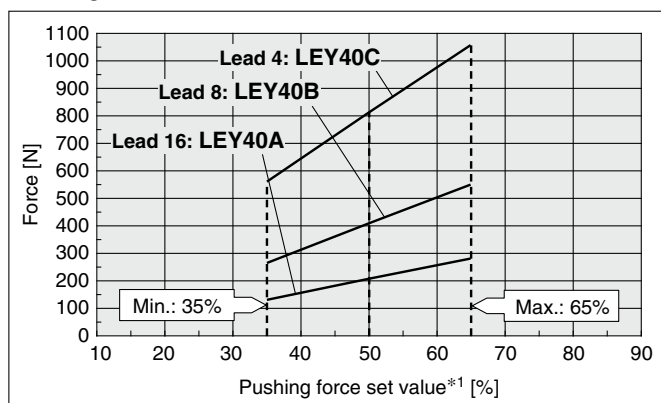

Ambient temperature	Pushing force set value*1 [%]	Duty ratio [%]	Continuous pushing time [min]
40°C or less	65 or less	100	No restriction

Servo Motor (24 VDC)

LEY25□A-X7

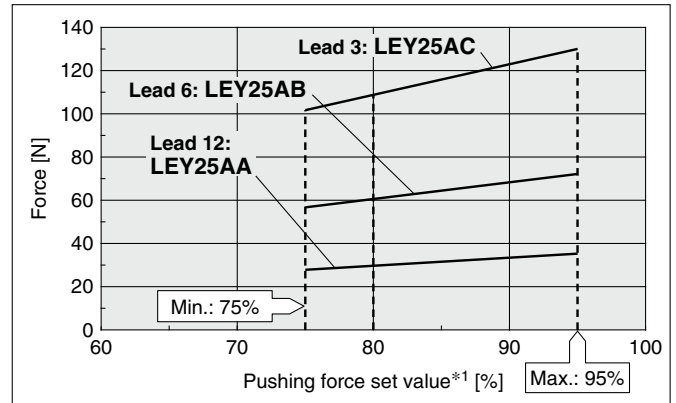

Ambient temperature	Pushing force set value*1 [%]	Duty ratio [%]	Continuous pushing time [min]
40°C or less	95 or less	100	No restriction

<Limit Values for Pushing Force and Trigger Level in Relation to Pushing Speed> Without Load

Model	Lead	Pushing speed [mm/s]	Pushing force (Setting input value)	Model	Lead	Pushing speed [mm/s]	Pushing force (Setting input value)
LEY25	A/B/C	21 to 35	50 to 65%	LEY25□A	A/B/C	21 to 35	80 to 95%
	A	24 to 30	60 to 85%				
	B/C	21 to 30	60 to 85%				
LEY32	A	24 to 30	50 to 65%				
	B/C	21 to 30	50 to 65%				

There is a limit to the pushing force in relation to the pushing speed. If the product is operated outside of the range (low pushing force), the completion signal [INP] may be output before the pushing operation has been completed (during the moving operation). If operating with the pushing speed below the min. speed, please check for operating problems before using the product.

<Set Values for Vertical Upward Transfer Pushing Operations>

For vertical loads (upward), set the pushing force to the max. value shown below and operate at the work load or less.

Model	LEY25□			LEY32□			LEY40□			LEY25□A		
	A	B	C	A	B	C	A	B	C	A	B	C
Work load [kg]	2.5	5	10	4.5	9	18	7	14	28	1.2	2.5	5
Pushing force	65%			85%			65%			95%		

*1 Set values for the controller

LEY-X7 Series

Incremental (Step Motor 24 VDC)

Incremental (Servo Motor 24 VDC)

Dust-tight/Water-jet-proof (IP65 Equivalent/IP67 Equivalent)

Graph of Allowable Lateral Load on the Rod End (Guide)

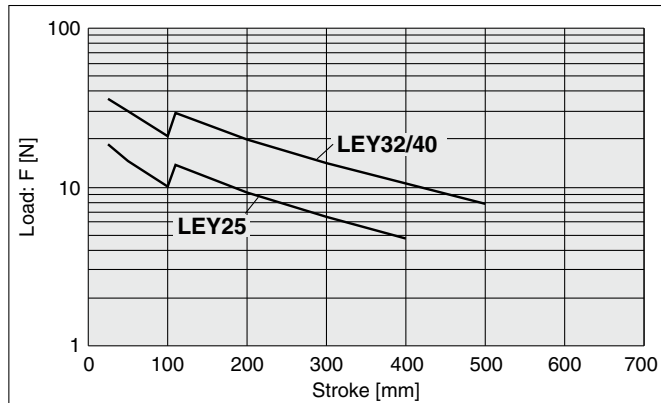

[Stroke] = [Product stroke] + [Distance from the rod end to the center of gravity of the workpiece]

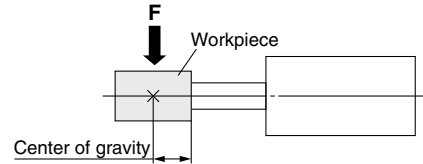

* The changes in the graph waveforms are due to the difference in components of different product strokes.

Rod Displacement: δ [mm]

Stroke Size	30	50	100	150	200	250	300	350	400	450	500
25	±0.3	±0.4	±0.7	±0.7	±0.9	±1.1	±1.3	±1.5	±1.7	—	—
32/40	±0.3	±0.4	±0.7	±0.6	±0.8	±1.0	±1.1	±1.3	±1.5	±1.7	±1.8

* The values without a load are shown.

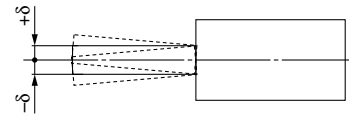

Non-rotating Accuracy of Rod

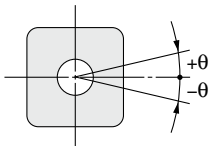

Size	Non-rotating accuracy θ
25	±0.8°
32/40	±0.7°

* Avoid using the electric actuator in such a way that rotational torque would be applied to the piston rod.

This may cause the deformation of the non-rotating guide, abnormal auto switch responses, play in the internal guide, or an increase in the sliding resistance.

Incremental (Step Motor 24 VDC) Incremental (Servo Motor 24 VDC)

Rod Type Dust-tight/Water-jet-proof (IP65 Equivalent/IP67 Equivalent)



* For details, refer to page 1343 and onward.

LEY-X7 (Made to Order) Series LEY25, 32, 40



Refer to pages 897 to 901 for model selection.

How to Order

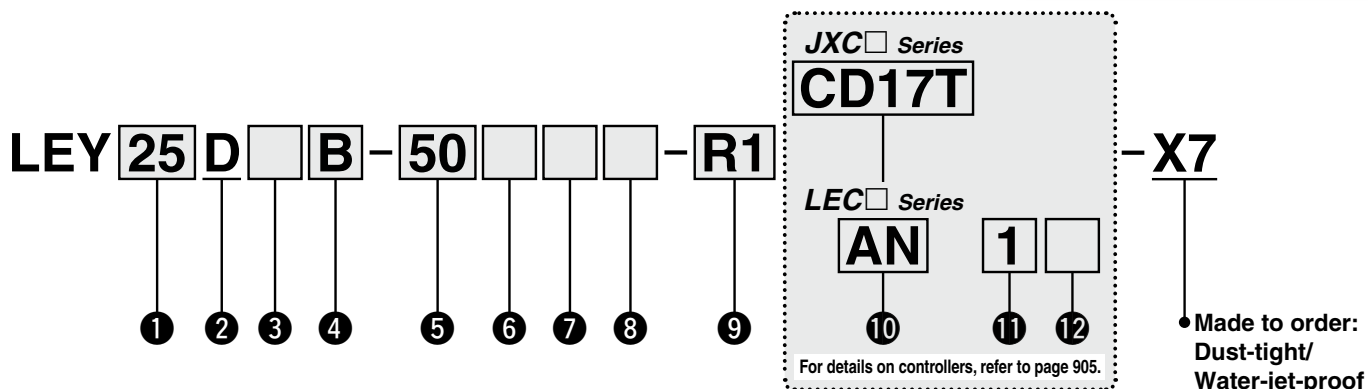
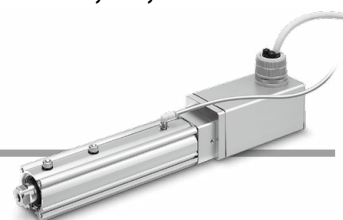

• Made to order:
Dust-tight/
Water-jet-proof

1 Size

25
32/40

2 Motor mounting position

D	In-line
---	---------

3 Motor type

Symbol	Type	Size		Compatible controllers/ drivers
		25	32/40	
Nil	Step motor (Servo/24 VDC)	●	●	JXC51 JXCEF JXC61 JXC9F JXCE1 JXCPF JXC91 JXCLF JXCP1 JXCD1 LECP1 JXCL1 LECPA JXCM1
A	Servo motor (24 VDC)	●	—	LECA6

4 Lead [mm]

Symbol	LEY25	LEY32/40
A	12	16
B	6	8
C	3	4

5 Stroke [mm]

30	30
to	to
500	500

* For details, refer to the applicable stroke table below.

6 Motor option

Nil	Without option
B	With lock

7 Rod end thread

Nil	Rod end female thread
M	Rod end male thread (1 rod end nut is included.)

8 Mounting*2

Symbol	Type	Motor mounting position
		In-line
Nil	Ends tapped/ Body bottom tapped*3	●
F	Rod flange*3	●

9 Actuator cable type/length

Robotic cable [m]			
R1	1.5	RA	10*5
R3	3	RB	15*5
R5	5	RC	20*5
R8	8*5		

Applicable Stroke Table*1

Model	Stroke [mm]	30	50	100	150	200	250	300	350	400	450	500	Manufacturable stroke range
		●	●	●	●	●	●	●	●	●	—	—	
LEY25		●	●	●	●	●	●	●	●	●	—	—	30 to 400
LEY32/40		●	●	●	●	●	●	●	●	●	●	●	30 to 500

●: Standard

* For auto switches, refer to pages 910 and 911.
* "-X7" is not added to an actuator model with a controller/driver part number suffix.
Example) "LEY25DB-100" for the LEY25DB-100BM-R1AN1-X7

JXC Series (For details, refer to page 905.)

10 Controller

Nil	Without controller
C□1□□	With controller

C D 1 7 T

Interface (Communication protocol/Input/Output)

Symbol	Type	Number of axes, Special specification	
		Standard	With STO sub-function
5	Parallel input (NPN)	●	
6	Parallel input (PNP)	●	
E	EtherCAT	●	●
9	EtherNet/IP™	●	●
P	PROFINET	●	●
D	DeviceNet®	●	
L	IO-Link	●	●
M	CC-Link	●	

Mounting

7	Screw mounting
8*10	DIN rail

Number of axes, Special specification

Symbol	Number of axes	Specification
1	Single axis	Standard
F	Single axis	With STO sub-function

Communication plug connector, I/O cable*11

Symbol	Type	Applicable interface
Nil	Without accessory	—
S	Straight type communication plug connector	DeviceNet®
T	T-branch type communication plug connector	CC-Link Ver. 1.10
1	I/O cable (1.5 m)	Parallel input (NPN) Parallel input (PNP)
3	I/O cable (3 m)	
5	I/O cable (5 m)	



LEC Series (For details, refer to page 905.)

A N 1

⑩ ⑪ ⑫

10 Controller/Driver type*6

Nil	Without controller/driver	
6N	LECA6	NPN
6P	(Step data input type)	PNP
1N	LECP1	NPN
1P	(Programless type)	PNP
AN	LECPA*7	NPN
AP	(Pulse input type)	PNP

11 I/O cable length*8, Communication plug

Nil	Without cable
1	1.5 m
3	3 m*9
5	5 m*9

12 Controller/Driver mounting

Nil	Screw mounting
D	DIN rail*10



- *1 Please contact SMC for non-standard strokes as they are produced as special orders.
- *2 The mounting bracket is shipped together with the product but does not come assembled.
- *3 For the horizontal cantilever mounting of the rod flange or ends tapped types, use the actuator within the following stroke range.
· LEY25: 200 mm or less · LEY32/40: 100 mm or less
- *4 The head flange type is not available for the LEY32/40.
- *5 Produced upon receipt of order (Robotic cable only)
- *6 For details on controllers/drivers and compatible motors, refer to the compatible controllers/drivers on the next page.
- *7 When pulse signals are open collector, order the current limiting resistor (LEC-PA-R-□) separately after referring to page 1062.

- *8 When "Without controller/driver" is selected for controller/driver types, I/O cable cannot be selected. Refer to page 1037 (For LECA6), page 1047 (For LECP1), or page 1062 (For LECPA) if an I/O cable is required.
- *9 When "Pulse input type" is selected for controller/driver types, pulse input usable only with differential. Only 1.5 m cables usable with open collector
- *10 The DIN rail is not included. It must be ordered separately.
- *11 Select "Nil" for anything other than DeviceNet®, CC-Link, or parallel input.
Select "Nil," "S," or "T" for DeviceNet® or CC-Link.
Select "Nil," "1," "3," or "5" for parallel input.

⚠ Caution

[CE/UKCA-compliant products]

- ① EMC compliance was tested by combining the electric actuator LEY series and the controller LEC/JXC series.
The EMC depends on the configuration of the customer's control panel and the relationship with other electrical equipment and wiring. Therefore, compliance with the EMC directive cannot be certified for SMC components incorporated into the customer's equipment under actual operating conditions. As a result, it is necessary for the customer to verify compliance with the EMC directive for the machinery and equipment as a whole.
- ② For the incremental (servo motor 24 VDC) specification, EMC compliance was tested by installing a noise filter set (LEC-NFA). Refer to page 1037 for the noise filter set. Refer to the LECA series Operation Manual for installation.

The actuator and controller/driver are sold as a package.

Confirm that the combination of the controller/driver and actuator is correct.

<Check the following before use.>

- ① Check the actuator label for the model number. This number should match that of the controller/driver.
- ② Check that the Parallel I/O configuration matches (NPN or PNP).

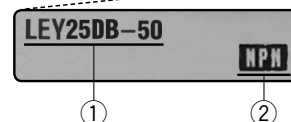

* Refer to the Operation Manual for using the products.
Please download it via our website: <https://www.smcworld.com>





LEY-X7 Series











Incremental (Step Motor 24 VDC)

Incremental (Servo Motor 24 VDC)

Dust-tight/Water-jet-proof (IP65 Equivalent/IP67 Equivalent)

Compatible Controllers/Drivers

Type	Step data input type	Step data input type	Programless type	Pulse input type
				
Series	JXC51 JXC61	LECA6	LECP1	LECPA
Features	Parallel I/O	Parallel I/O	Capable of setting up operation (step data) without using a PC or teaching box	Operation by pulse signals
Compatible motor	Step motor (Servo/24 VDC)	Servo motor (24 VDC)	Step motor (Servo/24 VDC)	
Max. number of step data	64 points		14 points	—
Power supply voltage	24 VDC			
Reference page	1017	1031	1042	1057

Type	EtherCAT direct input type	EtherCAT direct input type with STO sub-function	EtherNet/IP™ direct input type	EtherNet/IP™ direct input type with STO sub-function	PROFINET direct input type	PROFINET direct input type with STO sub-function	DeviceNet® direct input type	IO-Link direct input type	IO-Link direct input type with STO sub-function	CC-Link direct input type
										
Series	JXCE1	JXCEF	JXC91	JXC9F	JXCP1	JXC9F	JXCD1	JXCL1	JXCLF	JXCM1
Features	EtherCAT direct input	EtherCAT direct input with STO sub-function	EtherNet/IP™ direct input	EtherNet/IP™ direct input with STO sub-function	PROFINET direct input	PROFINET direct input with STO sub-function	DeviceNet® direct input	IO-Link direct input	IO-Link direct input with STO sub-function	CC-Link direct input
Compatible motor	Step motor (Servo/24 VDC)									
Max. number of step data	64 points									
Power supply voltage	24 VDC									
Reference page	1063									

LEY-X7 Series

Incremental (Step Motor 24 VDC)

Incremental (Servo Motor 24 VDC)

Dust-tight/Water-jet-proof (IP65 Equivalent/IP67 Equivalent)

Specifications

Servo Motor (24 VDC)

Model		LEY25□A-X7			
Actuator specifications	Work load*1 [kg]	Horizontal (3000 [mm/s ²])	7	15	30
		Vertical (3000 [mm/s ²])	2	5	11
	Pushing force [N]*2 *3		18 to 35	37 to 72	66 to 130
	Speed [mm/s]		2 to 300	1 to 150	1 to 75
	Max. acceleration/deceleration [mm/s ²]		3000		
	Pushing speed [mm/s]*4		35 or less		
	Positioning repeatability [mm]		±0.02		
	Lost motion [mm]*5		0.1 or less		
	Screw lead [mm]		12	6	3
	Impact/Vibration resistance [m/s ²]*6		50/20		
Actuation type		Ball screw + Belt (LEY□) Ball screw (LEY□D)			
Guide type		Sliding bushing (Piston rod)			
Enclosure*7		IP65 equivalent/IP67 equivalent			
Operating temperature range [°C]		5 to 40			
Operating humidity range [%RH]		90 or less (No condensation)			
Electric specifications	Motor size		□42		
	Motor type		Servo motor (24 VDC)		
	Encoder		Incremental		
	Power supply voltage [V]		24 VDC ±10%		
Lock unit specifications	Power [W]*8 *10		Max. power 96		
	Type*9		Non-magnetizing lock		
	Holding force [N]		78	157	294
	Power [W]*10		5		
	Rated voltage [V]		24 VDC ±10%		

- *1 Horizontal: The max. value of the work load. An external guide is necessary to support the load. (Friction coefficient of guide: 0.1 or less) The actual work load and transfer speed change according to the condition of the external guide.
Vertical: Speed changes according to the work load. Check the "Model Selection" on page 899.
The values shown in () are the acceleration/deceleration. Set these values to be 3000 [mm/s²] or less.
- *2 Pushing force accuracy is ±20% (F.S.).
- *3 The thrust setting values for LEY25A□ are 75% to 95%. The pushing force values change according to the duty ratio and pushing speed. Check the "Model Selection" on page 900.
- *4 The allowable speed for pushing operation When push conveying a workpiece, operate at the vertical work load or less.
- *5 A reference value for correcting errors in reciprocal operation
- *6 Impact resistance: No malfunction occurred when the actuator was tested with a drop tester in both an axial direction and a perpendicular direction to the lead screw. (The test was performed with the actuator in the initial state.)
Vibration resistance: No malfunction occurred in a test ranging between 45 to 2000 Hz. The test was performed in both an axial direction and a perpendicular direction to the lead screw. (The test was performed with the actuator in the initial state.)
- *7 Cannot be used in an environment where oil such as cutting oil splashes or it is constantly exposed to water Take appropriate protective measures. For details on enclosure, refer to the "Enclosure" on page 881.
- *8 Indicates the max. power during operation (including the controller). This value can be used for the selection of the power supply.
- *9 With lock only
- *10 For an actuator with lock, add the power for the lock.

Weight

Weight: In-line Motor Type

		LEY25D								
Stroke		30	50	100	150	200	250	300	350	400
Product weight [kg]	Step motor	1.49	1.56	1.73	1.98	2.16	2.33	2.51	2.68	2.86
	Servo motor	1.45	1.52	1.69	1.94	2.12	2.29	2.47	2.64	2.82

		LEY32D										
Stroke		30	50	100	150	200	250	300	350	400	450	500
Product weight [kg]	Step motor	2.59	2.70	2.99	3.37	3.66	3.95	4.23	4.52	4.81	5.09	5.38

		LEY40D										
Stroke		30	50	100	150	200	250	300	350	400	450	500
Product weight [kg]	Step motor	2.94	3.05	3.34	3.72	4.01	4.30	4.58	4.87	5.16	5.44	5.73

Additional Weight

[kg]

Size		25	32	40
Lock		0.33	0.63	0.63
Rod end male thread	Male thread	0.03	0.03	0.03
	Nut	0.02	0.02	0.02
Foot bracket (2 sets including mounting bolt)		0.08	0.14	0.14
Rod flange (including mounting bolt)		0.17	0.20	0.20
Head flange (including mounting bolt)				

Construction

In-line motor type: **LEY²⁵₃₂D₄₀**

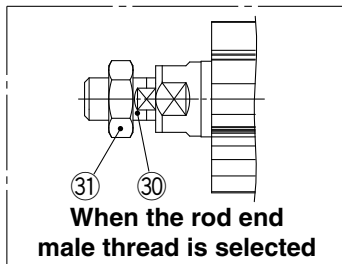
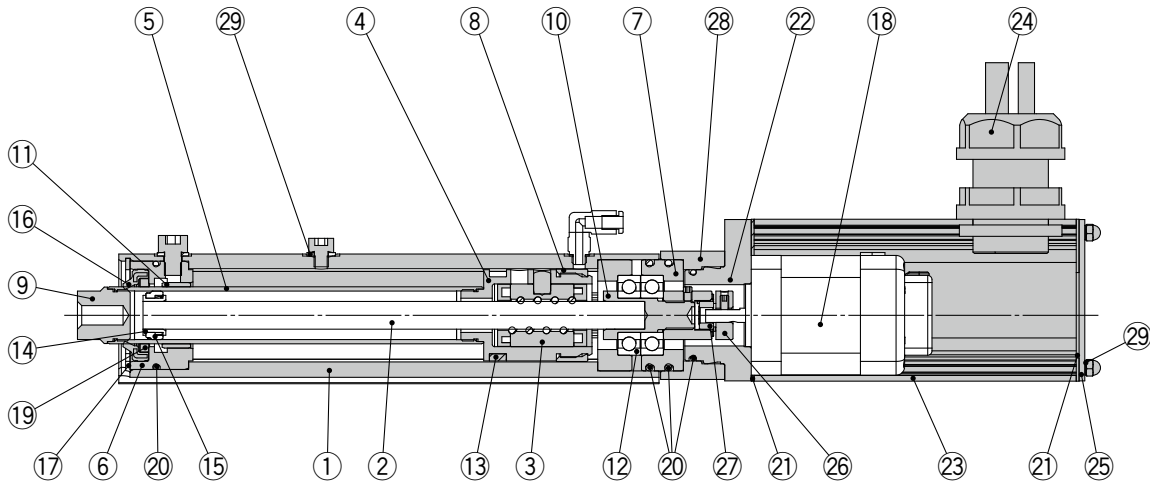

Component Parts

No.	Description	Material	Note
1	Body	Aluminum alloy	Anodized
2	Ball screw	Alloy steel	
3	Ball screw nut	Synthetic resin/Alloy steel	
4	Piston	Aluminum alloy	
5	Piston rod	Stainless steel	Hard chrome plating
6	Rod cover	Aluminum alloy	Anodized
7	Bearing holder	Aluminum alloy	
8	Rotation stopper	Resin	
9	Socket	Stainless steel	
10	Connected shaft	Free cutting carbon steel	Nickel plating
11	Bushing	Bearing alloy	
12	Bearing	—	
13	Magnet	—	
14	Wear ring holder	Stainless steel	Stroke 101 mm or more
15	Wear ring	Resin	Stroke 101 mm or more
16	Greater water resistant scraper	Stainless steel/NBR	

No.	Description	Material	Note
17	Retaining ring	Stainless steel	
18	Motor	—	
19	Lube-retainer	Felt	
20	O-ring	NBR	
21	Gasket	Chloroprene	
22	Motor adapter	Aluminum alloy	LEY25 only
23	Motor cover	Aluminum alloy	Anodized
24	Seal connector	—	
25	End cover	Aluminum alloy	Anodized
26	Hub	Aluminum alloy	
27	Spider	NBR	
28	Motor block	Aluminum alloy	Anodized
29	Seal washer	Stainless steel/NBR	
30	Socket (Male thread)	Stainless steel	
31	Nut	Stainless steel	

Replacement Parts/Grease Pack

Applied portion	Order no.
Piston rod	GR-S-010 (10 g)
	GR-S-020 (20 g)

* Apply grease to the piston rod periodically.
Grease should be applied when 1 million cycles or 200 km have been reached, whichever comes first.

LEY-X7 Series

Incremental (Step Motor 24 VDC)

Incremental (Servo Motor 24 VDC)

Dust-tight/Water-jet-proof (IP65 Equivalent/IP67 Equivalent)

Dimensions

In-line motor type

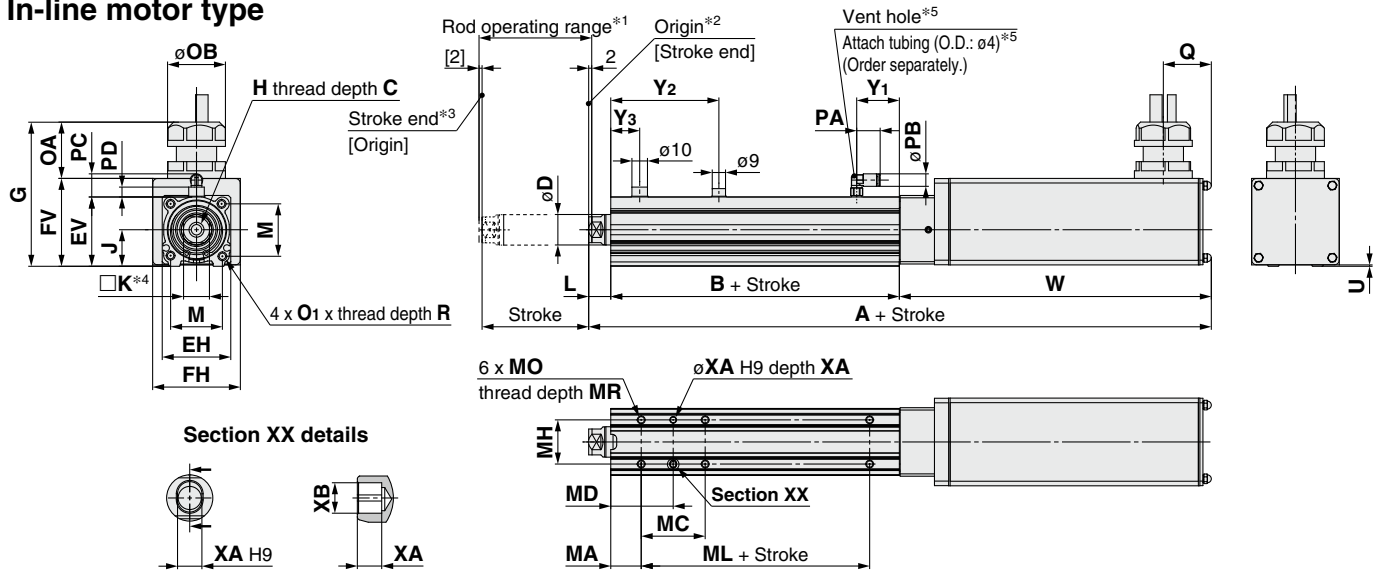

Rod end male thread: LEY32D□-□□M

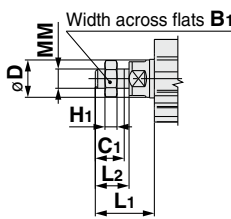

Size	B ₁	C ₁	D	H ₁	L ₁	L ₂	MM
25	22	20.5	20	8	38	23.5	M14 x 1.5
32/40	22	20.5	25	8	42	23.5	M14 x 1.5

* The L₁ measurement is when the unit is in the original position. At this position, 2 mm at the end.

Size	Stroke range [mm]	A		B	C	D	EH	EV	FH	FV	G	H	J	K	L	M
		Without lock	With lock													
25	30 to 100	259	309	89.5	13	20	44	45.5	57.6	57.7	94.7	M8 x 1.25	24	17	14.5	34
	105 to 400	284	334	114.5												
32	30 to 100	269.5	319.5	96	13	25	51	56.5	69.6	79.6	116.6	M8 x 1.25	31	22	18.5	40
	105 to 500	299.5	349.5	126												
40	30 to 100	291.5	341.5	96	13	25	51	56.5	69.6	79.6	116.6	M8 x 1.25	31	22	18.5	40
	105 to 500	321.5	371.5	126												

Size	Stroke range [mm]	O ₁	R	OA	OB	PA	PB	PC	PD	Q	U	W		Y ₁	Y ₂	Y ₃
												Without lock	With lock			
25	30 to 100	M5 x 0.8	8	37	38	15.4	8.2	15.9	6.5	31.5	0.9	155	205	28	71	19
	105 to 400														96	
32	30 to 100	M6 x 1.0	10	37	38	15.4	8.2	15.9	7.1	31.5	1	155	205	30	75.5	16
	105 to 500														105.5	
40	30 to 100	M6 x 1.0	10	37	38	15.4	8.2	15.9	7.1	31.5	1	177	227	30	75.5	16
	105 to 500														105.5	

Body Bottom Tapped

Size	Stroke range [mm]	MA	MC	MD	MH	ML	MO	MR	XA	XB
25	30 to 39	20	24	32	29	50	M5 x 0.8	6.5	4	5
	40 to 100		42	41						
	101 to 124		59	49.5		75				
	125 to 200									
	201 to 400									
32/40	30 to 39	25	22	36	30	50	M6 x 1	8.5	5	6
	40 to 100		36	43						
	101 to 124		53	51.5		80				
	125 to 200									
	201 to 500									

*1 This is the range within which the rod can move when it returns to origin.

Make sure that workpieces mounted on the rod do not interfere with other workpieces or the facilities around the rod.

*2 Position after returning to origin

*3 [] for when the direction of return to origin has changed

*4 The direction of rod end width across flats (□K) differs depending on the products.

*5 The vent hole is the port for releasing to atmosphere. Do not apply pressure to this hole.

Attach tubing to the vent hole and place the end of the tubing so it is not exposed to dust or water.

For the mounting bracket dimensions, refer to the **Web Catalog**.

LEY-X7 Series Auto Switch Mounting

Auto Switch Proper Mounting Position

Applicable auto switch: D-M9□A(V)

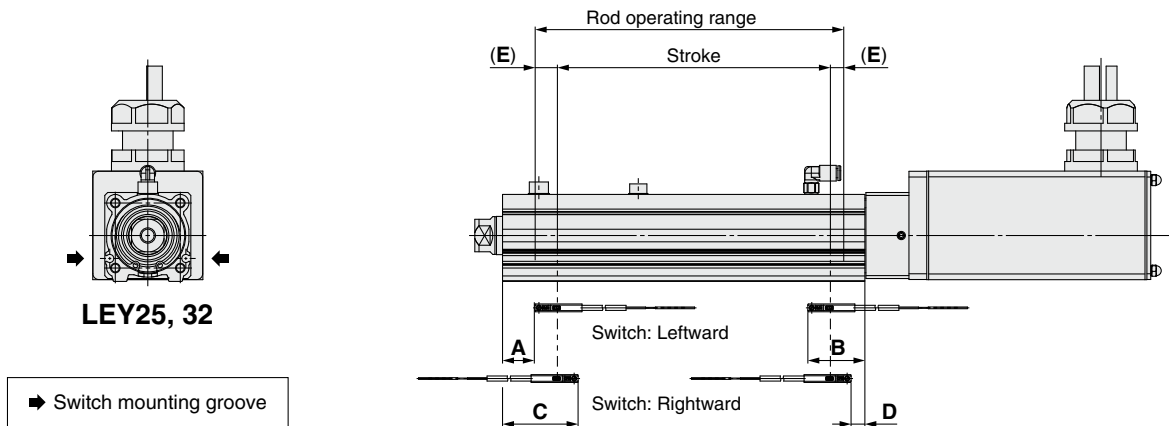

Size	Stroke range	Auto switch position				Return to origin distance	Operating range
		Leftward mounting		Rightward mounting			
		A	B	C	D		
25	15 to 100	27	62.5	39	50.5	(2)	4.2
	105 to 400	52		64			
32/40	20 to 100	30.5	85.5	42.5	53.5	(2)	4.9
	105 to 500	90.5		102.5			

- * The values in the table above are to be used as a reference when mounting auto switches for stroke end detection. Adjust the auto switch after confirming the operating conditions in the actual setting.
- * Since the operating range is provided as a guideline including hysteresis, it cannot be guaranteed (assuming approx. $\pm 30\%$ dispersion). It may change substantially depending on the ambient environment.

Auto Switch Mounting

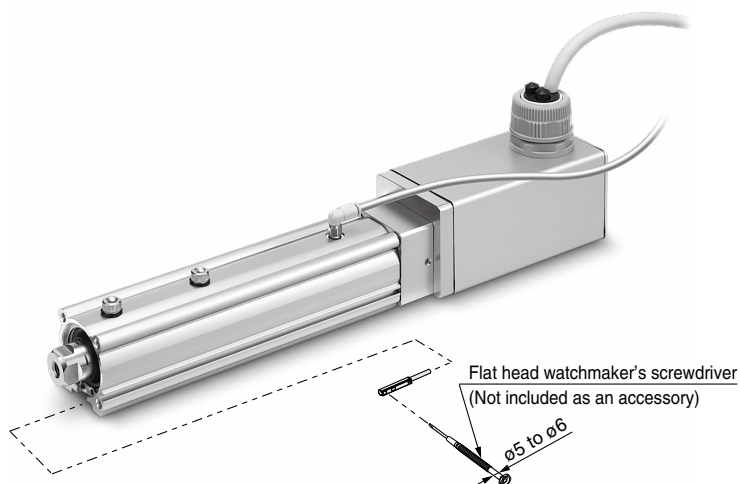

Tightening Torque for Auto Switch Mounting Screw [N·m]

Auto switch model	Tightening torque
D-M9□A(V)	0.05 to 0.10

- * When tightening the auto switch mounting screw (included with the auto switch), use a watchmaker's screwdriver with a handle diameter of 5 to 6 mm.

Water Resistant 2-Color Indicator Solid State Auto Switch: Direct Mounting Type D-M9NA(V)/D-M9PA(V)/D-M9BA(V)

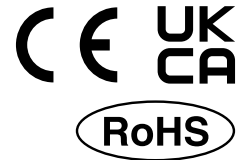

Grommet

- Water (coolant) resistant type
- 2-wire load current is reduced (2.5 to 40 mA).
- The proper operating range can be determined by the color of the light. (Red → Green ← Red)
- Using flexible cable as standard spec.

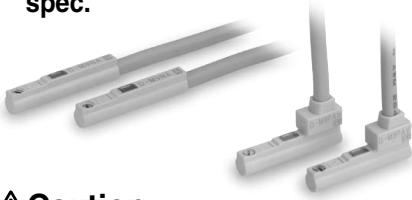

Caution

Precautions

Fix the auto switch with the existing screw installed on the auto switch body. The auto switch may be damaged if a screw other than the one supplied is used. Please contact SMC if using coolant liquid other than water based solution.

Weight

[g]

Auto switch model	D-M9NA(V)	D-M9PA(V)	D-M9BA(V)
Lead wire length			
0.5 m (Nil)	8	7	
1 m (M)	14	13	
3 m (L)	41	38	
5 m (Z)	68	63	

Dimensions

[mm]

D-M9□A

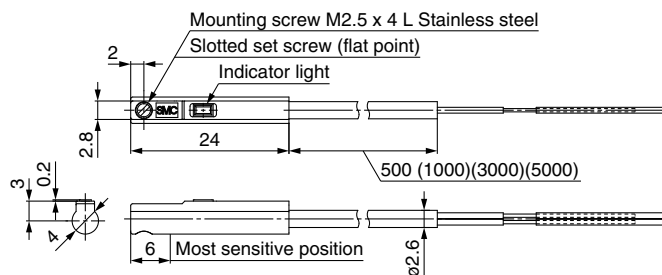

D-M9□AV

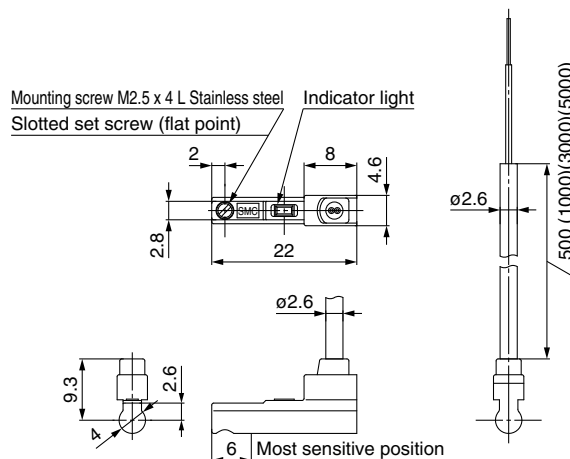

Auto Switch Specifications

PLC: Programmable Logic Controller

D-M9□A, D-M9□AV (With indicator light)						
Auto switch model	D-M9NA	D-M9NAV	D-M9PA	D-M9PAV	D-M9BA	D-M9BAV
Electrical entry direction	In-line	Perpendicular	In-line	Perpendicular	In-line	Perpendicular
Wiring type	3-wire				2-wire	
Output type	NPN		PNP		—	
Applicable load	IC circuit, Relay, PLC				24 VDC relay, PLC	
Power supply voltage	5, 12, 24 VDC (4.5 to 28 V)				—	
Current consumption	10 mA or less				—	
Load voltage	28 VDC or less		—		24 VDC (10 to 28 VDC)	
Load current	40 mA or less				2.5 to 40 mA	
Internal voltage drop	0.8 V or less at 10 mA (2 V or less at 40 mA)				4 V or less	
Leakage current	100 µA or less at 24 VDC				0.8 mA or less	
Indicator light	Operating range Red LED illuminates. Proper operating range Green LED illuminates.					
Standard	CE/UKCA marking					

Oilproof Flexible Heavy-duty Lead Wire Specifications

Auto switch model		D-M9NA□	D-M9NAV□	D-M9PA□	D-M9PAV□	D-M9BA□	D-M9BAV□
Sheath	Outside diameter [mm]	ø2.6					
Insulator	Number of cores	3 cores (Brown/Blue/Black)				2 cores (Brown/Blue)	
	Outside diameter [mm]	ø0.88					
Conductor	Effective area [mm ²]	0.15					
	Strand diameter [mm]	ø0.05					
Min. bending radius [mm]		17					

* Refer to page 1363 for solid state auto switch common specifications.

* Refer to page 1363 for lead wire lengths.

Environment

Dust-tight/Water-jet-proof (IP65 Equivalent)

LEY-X5 (Made to Order)

LEY63□□□-□P

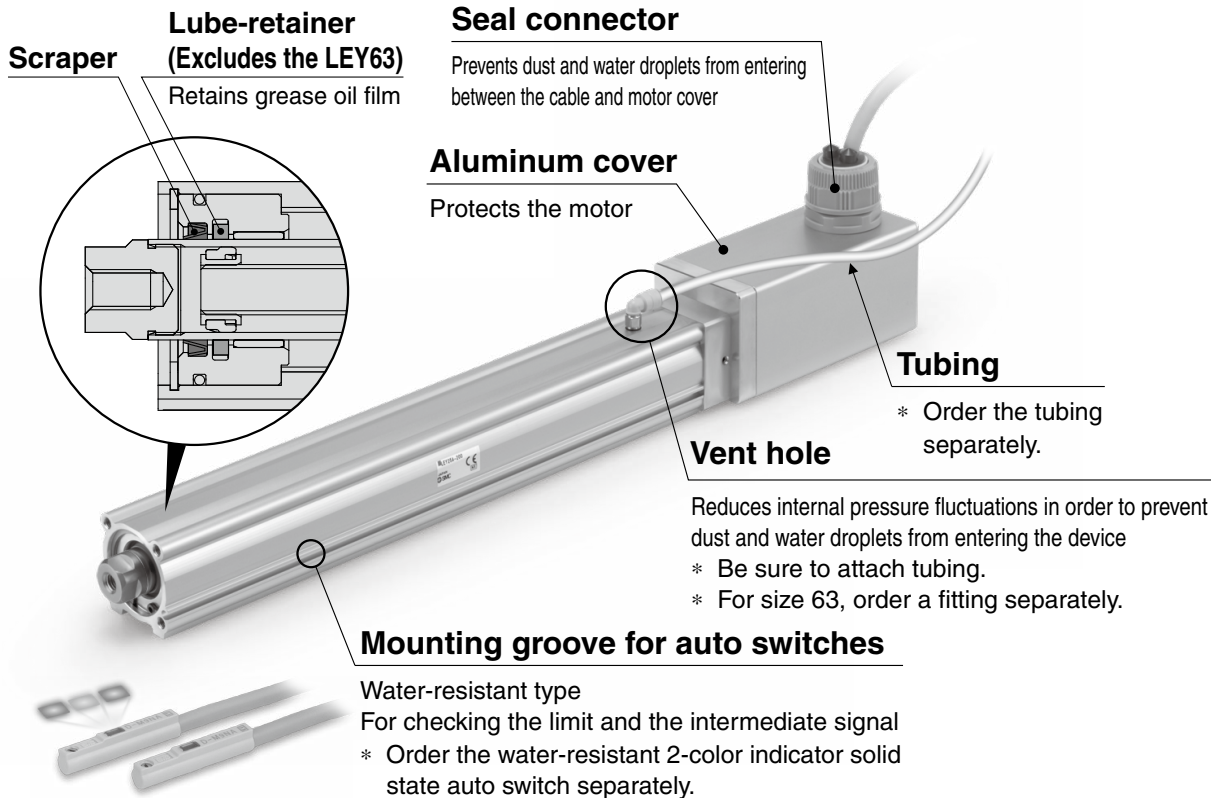

*1 IP65 enclosure: The protection structure against solid foreign objects is dust-tight type and the protection structure against water is water-jet-proof type. Dust-tight means that no dust can enter the inside of the equipment.

Water-jet-proof means that the product is not adversely affected by direct water jets from any direction. That is, even when direct water jets are applied to the product for 3 minutes by means of the pre-determined method, there is no water entry that hinders the correct operation inside the equipment. Be sure to take appropriate protective measures if the product is to be used in an environment where it will be constantly exposed to water or fluids other than water splash. In particular, the product cannot be used in environments where oils, such as cutting oil or cutting fluid, are present.

LEY-X5 (Made to Order) Size 25, 32

Step Motor (Servo/24 VDC)

Servo Motor (24 VDC)

p. 917



AC Servo Motor (100/200 W)

p. 925, 931

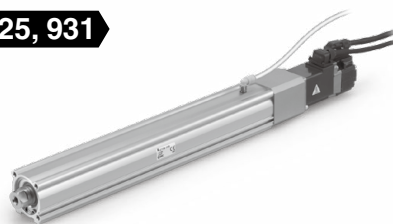

LEY63□□□-□P Size 63

AC Servo Motor (400 W)

p. 473, 489

* Option



Rod Type

LEY-X5 Series Dust-tight/Water-jet-proof (IP65 Equivalent)

Model Selection

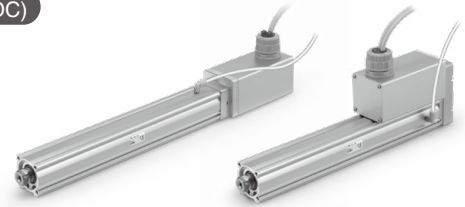

Refer to page 914 for the LECPA, JXC□ $\frac{3}{2}$, and LECA6.

LEY-X5 Series ▶ p. 917

Speed-Work Load Graph (Guide) For Step Motor (Servo/24 VDC) JXC□1, LECP1

Horizontal

LEY25□-X5 for acceleration/deceleration: 2000 mm/s²

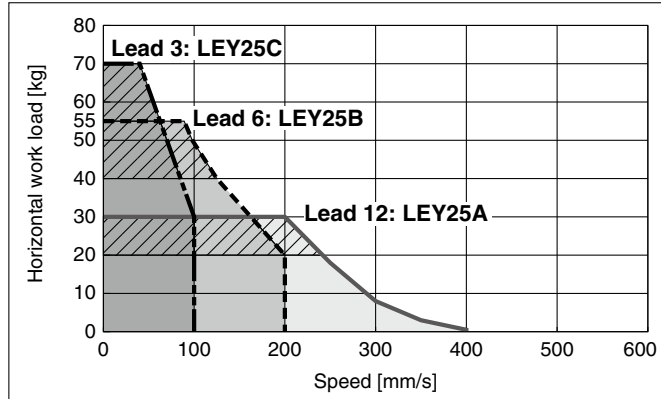

LEY32□-X5 for acceleration/deceleration: 2000 mm/s²

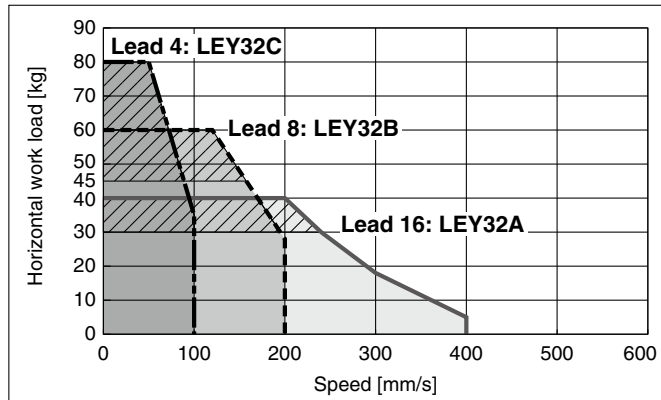

Vertical

LEY25□-X5

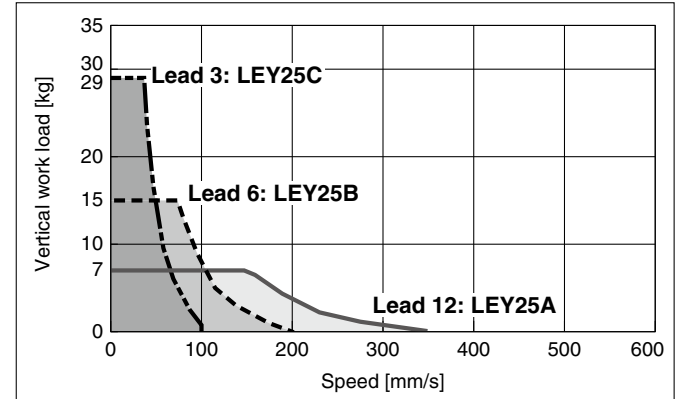

LEY32□-X5

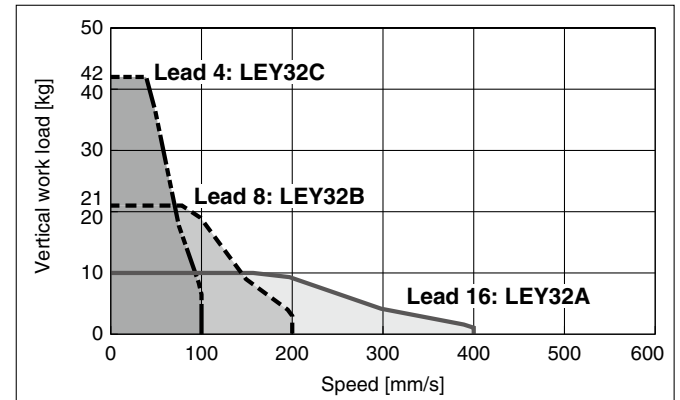

Graph of Allowable Lateral Load on the Rod End (Guide)

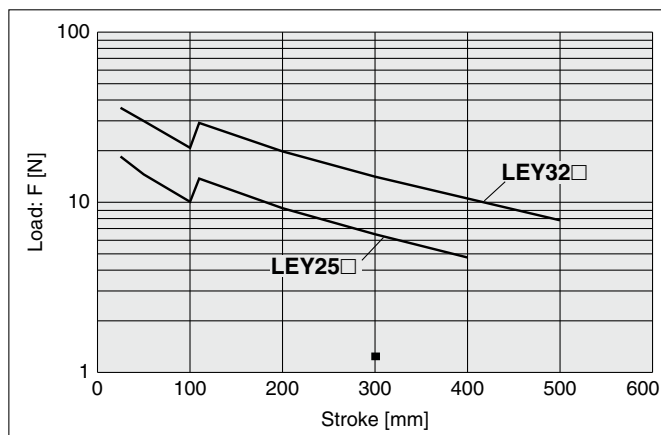

* The changes in the graph waveforms are due to the difference in components of different product strokes.

$$[\text{Stroke}] = [\text{Product stroke}] + [\text{Distance from the rod end to the center of gravity of the workpiece}]$$

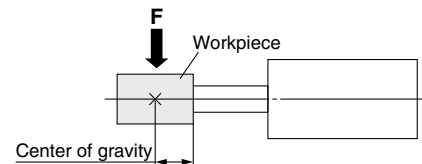

Rod Displacement: δ [mm]

Stroke \ Size	30	50	100	150	200	250	300	350	400	450	500
25	±0.3	±0.4	±0.7	±0.7	±0.9	±1.1	±1.3	±1.5	±1.7	—	—
32	±0.3	±0.4	±0.7	±0.6	±0.8	±1.0	±1.1	±1.3	±1.5	±1.7	±1.8

* The values without a load are shown.

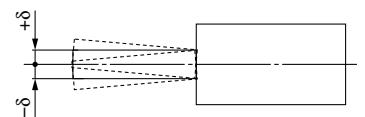



Refer to page 913 for the JXC□1, LECP1 and below for the LECA6.

Speed-Work Load Graph (Guide) For Step Motor (Servo/24 VDC) LECPA, JXC□₂/₃

Horizontal

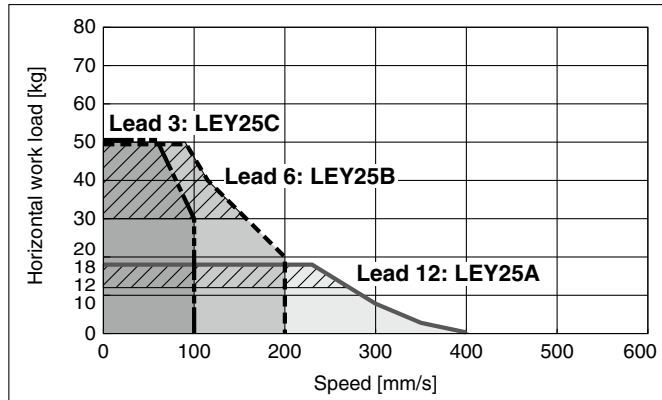
LEY25□-X5  for acceleration/deceleration: 2000 mm/s²



LEY32□-X5  for acceleration/deceleration: 2000 mm/s²

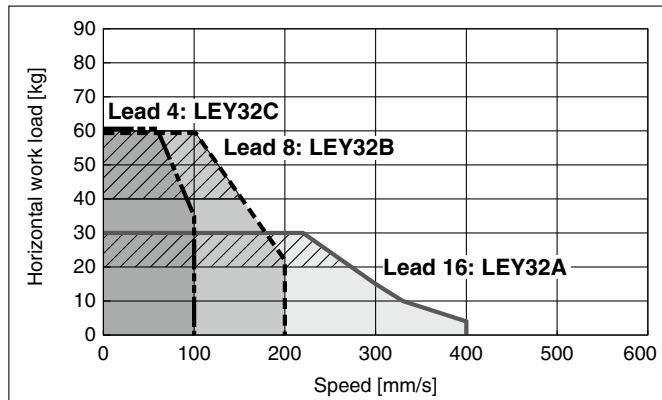

Vertical

LEY25□-X5

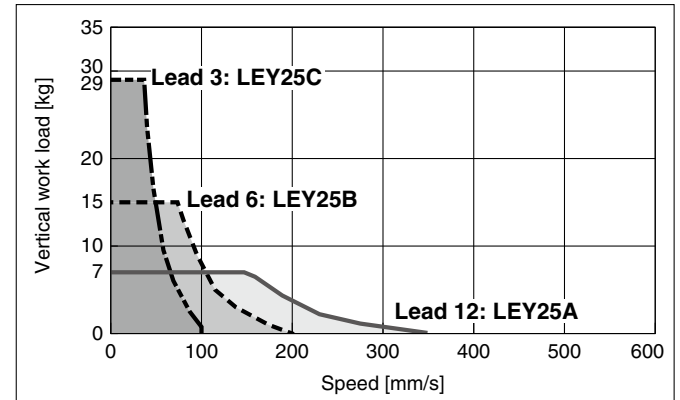

LEY32□-X5

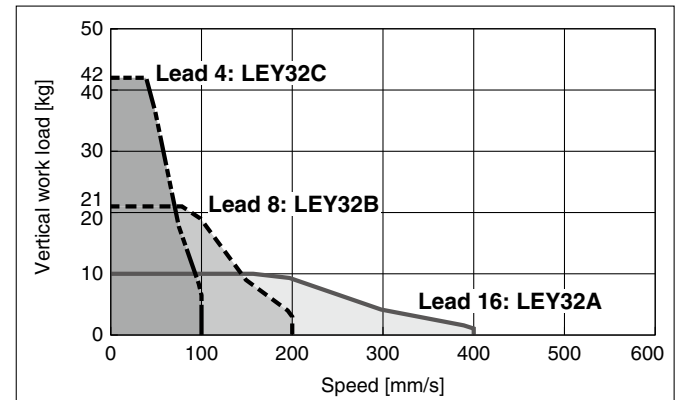

For Servo Motor (24 VDC) LECA6

Horizontal

LEY25□A-X5

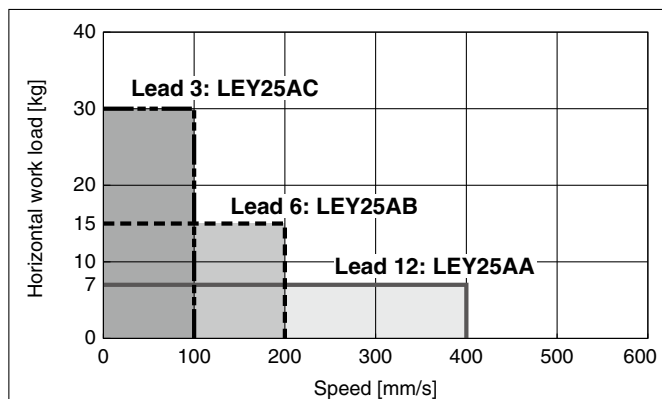

Vertical

LEY25□A-X5

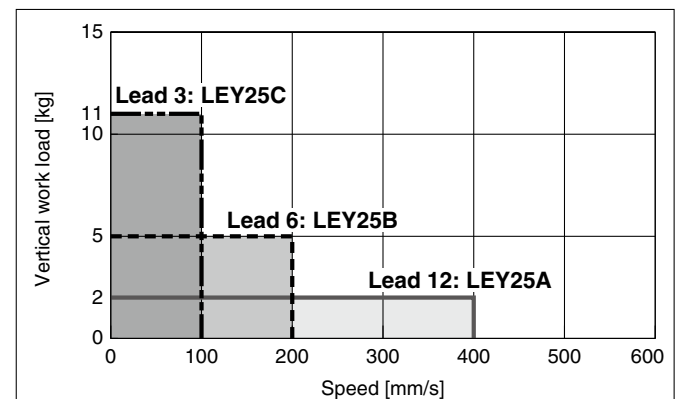

LEY-X5 Series

Incremental (Step Motor 24 VDC)

Incremental (Servo Motor 24 VDC)

Dust-tight/Water-jet-proof (IP65 Equivalent)

Force Conversion Graph

Step Motor (Servo/24 VDC)

LEY25□-X5

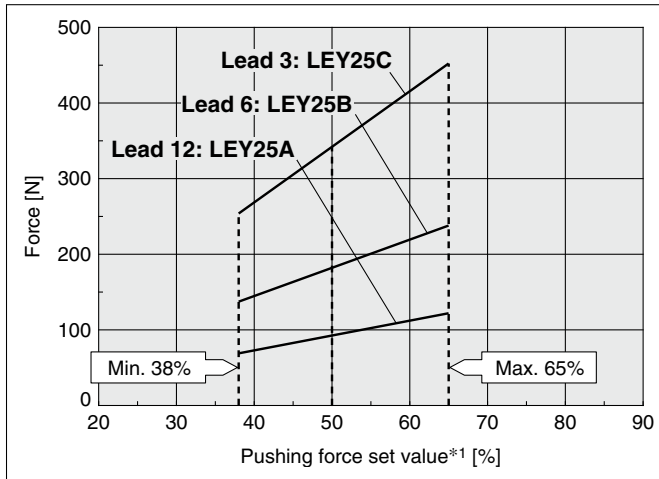

Ambient temperature	Pushing force set value*1 [%]	Duty ratio [%]	Continuous pushing time [min]
40°C or less	65 or less	100	No restriction

LEY32□-X5

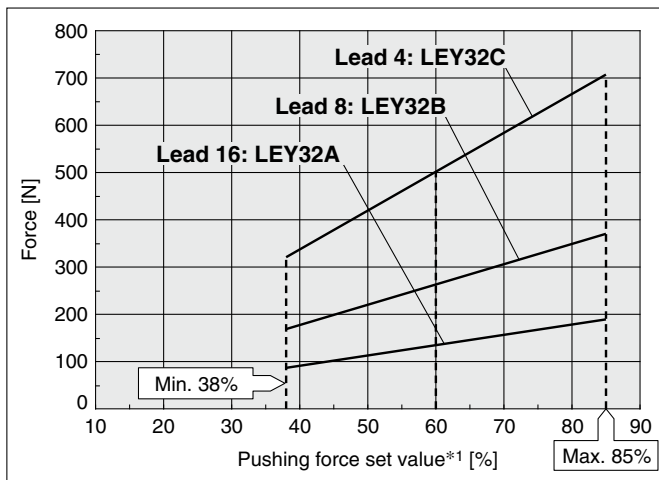

Ambient temperature	Pushing force set value*1 [%]	Duty ratio [%]	Continuous pushing time [min]
25°C or less	85 or less	100	No restriction
40°C	65 or less	100	No restriction
	85	50	15 or less

Non-rotating Accuracy of Rod

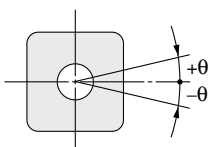

Size	Non-rotating accuracy θ
25	$\pm 0.8^\circ$
32	$\pm 0.7^\circ$

* Avoid using the electric actuator in such a way that rotational torque would be applied to the piston rod. Failure to do so may result in the deformation of the non-rotating guide, abnormal auto switch responses, play in the internal guide, or an increase in the sliding resistance.

Servo Motor (24 VDC)

LEY25□A-X5

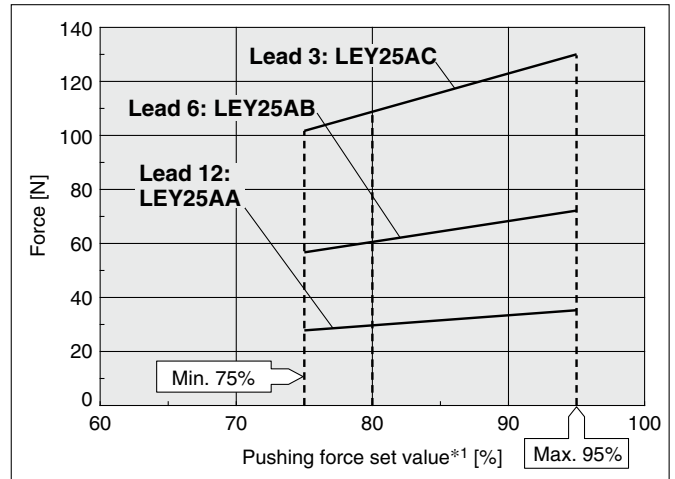

Ambient temperature	Pushing force set value*1 [%]	Duty ratio [%]	Continuous pushing time [min]
40°C or less	95 or less	100	No restriction

<Limit Values for Pushing Force and Trigger Level in Relation to Pushing Speed> Without Load

Model	Lead	Pushing speed [mm/s]	Pushing force (Setting input value)	Model	Lead	Pushing speed [mm/s]	Pushing force (Setting input value)
LEY25	A/B/C	21 to 35	50 to 65%	LEY25□A	A/B/C	21 to 35	80 to 95%
	A	24 to 30			B/C	21 to 30	
LEY32			60 to 85%				

There is a limit to the pushing force in relation to the pushing speed. If the product is operated outside of the range (low pushing force), the completion signal [INP] may be output before the pushing operation has been completed (during the moving operation). If operating with the pushing speed below the min. speed, please check for operating problems before using the product.

<Set Values for Vertical Upward Transfer Pushing Operations>

For vertical loads (upward), set the pushing force to the max. value shown below and operate at the work load or less.

Model	LEY25□			LEY32□			LEY25□A		
	A	B	C	A	B	C	A	B	C
Work load [kg]	2.5	5	10	4.5	9	18	1.2	2.5	5
Pushing force	65%			85%			95%		

*1 Set values for the controller

Incremental (Step Motor 24 VDC)

Incremental (Servo Motor 24 VDC)

Rod Type Dust-tight/Water-jet-proof (IP65 Equivalent)



* For details, refer to page 1343 and onward.

LEY-X5 (Made to Order) Series LEY25, 32



Refer to pages 913 to 915 for model selection.

How to Order

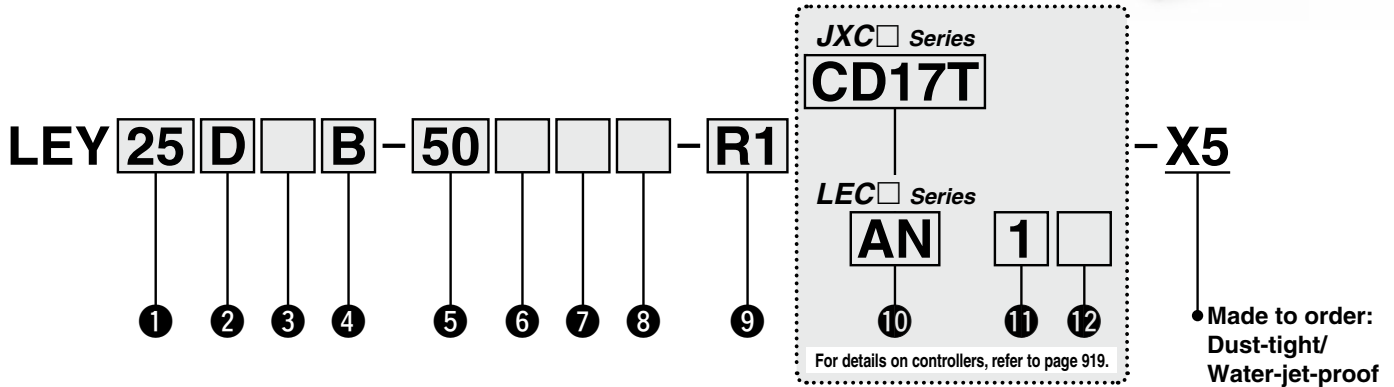
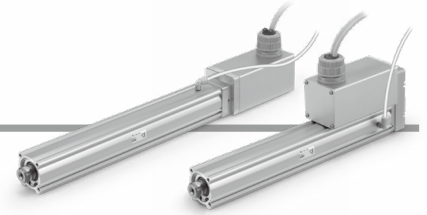

1 Size

25
32

2 Motor mounting position

Nil	Top side parallel
D	In-line

3 Motor type

Symbol	Type	Size		Compatible controllers/drivers
		25	32	
Nil	Step motor (Servo/24 VDC)	●	●	JXC51 JXCEF JXC61 JXC9F JXC E1 JXCPF JXC91 JXCLF JXCP1 JXCD1 LECP1 JXCL1 LECPA JXCM1
A	Servo motor (24 VDC)	●	—	LECA6

4 Lead [mm]

Symbol	LEY25	LEY32
A	12	16
B	6	8
C	3	4

5 Stroke [mm]

30	30
to	to
500	500

* For details, refer to the applicable stroke table below.

6 Motor option*2

Nil	Without option
B	With lock

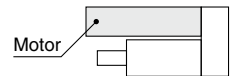

7 Rod end thread

Nil	Rod end female thread
M	Rod end male thread (1 rod end nut is included.)

8 Mounting*3

Symbol	Type	Motor mounting position	
		Parallel	In-line
Nil	Ends tapped/Body bottom tapped*4	●	●
L	Foot bracket	●	—
F	Rod flange*4	●*5	●
G	Head flange*4	●*6	—

9 Actuator cable type/length

Robotic cable [m]			
R1	1.5	RA	10*7
R3	3	RB	15*7
R5	5	RC	20*7
R8	8*7		

Applicable Stroke Table*1

Model	Stroke [mm]	30	50	100	150	200	250	300	350	400	450	500	Manufacturable stroke range
		●	●	●	●	●	●	●	●	●	—	—	
LEY25		●	●	●	●	●	●	●	●	●	—	—	15 to 400
LEY32		●	●	●	●	●	●	●	●	●	●	●	20 to 500

●: Standard

* For auto switches, refer to pages 936 and 937.
 * "-X5" is not added to an actuator model with a controller/driver part number suffix.
 Example) "LEY25DB-100" for the LEY25DB-100BM-R1AN1-X5

JXC Series (For details, refer to page 919.)

10 Controller

Nil	Without controller
C□1□□	With controller

C D 1 7 T

Interface (Communication protocol/Input/Output)

Symbol	Type	Number of axes, Special specification	
		Standard	With STO sub-function
5	Parallel input (NPN)	●	
6	Parallel input (PNP)	●	
E	EtherCAT	●	●
9	EtherNet/IP™	●	●
P	PROFINET	●	●
D	DeviceNet®	●	
L	IO-Link	●	●
M	CC-Link	●	

Mounting

7	Screw mounting
8*13	DIN rail

Number of axes, Special specification

Symbol	Number of axes	Specification
1	Single axis	Standard
F	Single axis	With STO sub-function

Communication plug connector, I/O cable*14

Symbol	Type	Applicable interface
Nil	Without accessory	—
S	Straight type communication plug connector	DeviceNet®
T	T-branch type communication plug connector	CC-Link Ver. 1.10
1	I/O cable (1.5 m)	Parallel input (NPN) Parallel input (PNP)
3	I/O cable (3 m)	
5	I/O cable (5 m)	



LEC Series (For details, refer to page 919.)

AN 1 □

10 Controller/Driver type*8

Nil	Without controller/driver	
6N	LECA6	NPN
6P	(Step data input type)	PNP
1N	LECP1 *9	NPN
1P	(Programless type)	PNP
AN	LECPA *9*10	NPN
AP	(Pulse input type)	PNP

11 I/O cable length*11

Nil	Without cable
1	1.5 m
3	3 m*12
5	5 m*12

12 Controller/Driver mounting

Nil	Screw mounting
D	DIN rail*13



- *1 Please contact SMC for non-standard strokes as they are produced as special orders.
- *2 When "With lock" is selected for the top side parallel motor type, the motor body will stick out from the end of the body for strokes of 50 mm or less. Check for interference with workpieces before selecting a model.
- *3 The mounting bracket is shipped together with the product but does not come assembled.
- *4 For the horizontal cantilever mounting of the rod flange, head flange, or ends tapped types, use the actuator within the following stroke range.
·LEY25: 200 mm or less ·LEY32: 100 mm or less
- *5 The rod flange type is not available for the LEY25/32 with strokes of 50 mm or less and motor option "With lock."
- *6 The head flange type is not available for the LEY32.
- *7 Produced upon receipt of order (Robotic cable only)
- *8 For details on controllers/drivers and compatible motors, refer to the compatible controllers/drivers on the next page.

- *9 Only available for the motor type "Step motor"
- *10 When pulse signals are open collector, order the current limiting resistor (LEC-PA-R-□) on page 1062 separately.
- *11 When "Without controller/driver" is selected for controller/driver types, I/O cable cannot be selected. Refer to page 1037 (For LECA6), page 1047 (For LECP1), or page 1062 (For LECPA) if an I/O cable is required.
- *12 When "Pulse input type" is selected for controller/driver types, pulse input usable only with differential. Only 1.5 m cables usable with open collector
- *13 The DIN rail is not included. It must be ordered separately.
- *14 Select "Nil" for anything other than DeviceNet®, CC-Link, or parallel input.
Select "Nil," "S," or "T" for DeviceNet® or CC-Link.
Select "Nil," "1," "3," or "5" for parallel input.

⚠ Caution

[CE/UKCA-compliant products]

- ① EMC compliance was tested by combining the electric actuator LEY series and the controller LEC/JXC series.
The EMC depends on the configuration of the customer's control panel and the relationship with other electrical equipment and wiring. Therefore, compliance with the EMC directive cannot be certified for SMC components incorporated into the customer's equipment under actual operating conditions. As a result, it is necessary for the customer to verify compliance with the EMC directive for the machinery and equipment as a whole.
- ② For the incremental (servo motor 24 VDC) specification, EMC compliance was tested by installing a noise filter set (LEC-NFA). Refer to page 1037 for the noise filter set. Refer to the LECA series Operation Manual for installation.

The actuator and controller/driver are sold as a package.

Confirm that the combination of the controller/driver and actuator is correct.

<Check the following before use.>

- ① Check the actuator label for the model number. This number should match that of the controller/driver.
- ② Check that the Parallel I/O configuration matches (NPN or PNP).

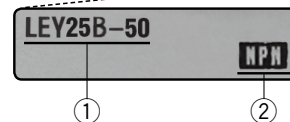

* Refer to the Operation Manual for using the products. Please download it via our website: <https://www.smcworld.com>





LEY-X5 Series











Incremental (Step Motor 24 VDC)

Incremental (Servo Motor 24 VDC)

Dust-tight/Water-jet-proof (IP65 Equivalent)

Compatible Controllers/Drivers

Type	Step data input type	Step data input type	Programless type	Pulse input type
				
Series	JXC51 JXC61	LECA6	LECP1	LECPA
Features	Parallel I/O	Parallel I/O	Capable of setting up operation (step data) without using a PC or teaching box	Operation by pulse signals
Compatible motor	Step motor (Servo/24 VDC)	Incremental (Servo motor 24 VDC)	Step motor (Servo/24 VDC)	
Max. number of step data	64 points		14 points	—
Power supply voltage	24 VDC			
Reference page	1017	1031	1042	1057

Type	EtherCAT direct input type	EtherCAT direct input type with STO sub-function	EtherNet/IP™ direct input type	EtherNet/IP™ direct input type with STO sub-function	PROFINET direct input type	PROFINET direct input type with STO sub-function	DeviceNet® direct input type	IO-Link direct input type	IO-Link direct input type with STO sub-function	CC-Link direct input type
										
Series	JXCE1	JXCEF	JXC91	JXC9F	JXCP1	JXC9F	JXCD1	JXCL1	JXCLF	JXCM1
Features	EtherCAT direct input	EtherCAT direct input with STO sub-function	EtherNet/IP™ direct input	EtherNet/IP™ direct input with STO sub-function	PROFINET direct input	PROFINET direct input with STO sub-function	DeviceNet® direct input	IO-Link direct input	IO-Link direct input with STO sub-function	CC-Link direct input
Compatible motor	Step motor (Servo/24 VDC)									
Max. number of step data	64 points									
Power supply voltage	24 VDC									
Reference page	1063									

Specifications

Step Motor (Servo/24 VDC)

Model		LEY25□-X5			LEY32□-X5					
Actuator specifications	Work load [kg] ^{*1}	Horizontal	For JXC□1, JXC□F, LEC□P1	(3000 [mm/s ²])	20	40	60	30	45	60
			(2000 [mm/s ²])	30	60	70	40	60	80	
		Vertical ^{*12}	For LEC□PA JXC□ ₂ ₃	(3000 [mm/s ²])	12	30	30	20	40	40
			(2000 [mm/s ²])	18	50	50	30	60	60	
	Pushing force [N] ^{*2 *3 *4}		63 to 122		126 to 238	232 to 452	80 to 189	156 to 370	296 to 707	
Speed [mm/s] ^{*4}		18 to 400		9 to 200	5 to 100	24 to 400	12 to 200	6 to 100		
Max. acceleration/deceleration [mm/s ²]				3000						
Pushing speed [mm/s] ^{*5}				35 or less		30 or less				
Positioning repeatability [mm]				±0.02						
Lost motion [mm] ^{*6}				0.1 or less						
Screw lead [mm]		12	6	3	16	8	4			
Impact/Vibration resistance [m/s ²] ^{*7}				50/20						
Actuation type				Ball screw + Belt (LEY□)		Ball screw (LEY□D)				
Guide type				Sliding bushing (Piston rod)						
Enclosure ^{*8}				IP65 equivalent						
Operating temperature range [°C]				5 to 40						
Operating humidity range [%RH]				90 or less (No condensation)						
Electric specifications	Motor size		□42		□56.4					
	Motor type				Step motor (Servo/24 VDC)					
	Encoder				Incremental					
	Power supply voltage [V]				24 VDC ±10%					
Lock unit specifications	Power [W] ^{*9 *11}		Max. power 48		Max. power 104					
	Type ^{*10}				Non-magnetizing lock					
	Holding force [N]		78	157	294	108	216	421		
Power [W] ^{*11}		5				5				
Rated voltage [V]				24 VDC ±10%						

*1 Horizontal: The max. value of the work load. An external guide is necessary to support the load. (Friction coefficient of guide: 0.1 or less) The actual work load and transfer speed change according to the condition of the external guide. Also, speed changes according to the work load. Check the "Model Selection" on pages 913 and 914.

Vertical: Speed changes according to the work load. Check the "Model Selection" on pages 913 and 914.

The values shown in () are the acceleration/deceleration. Set these values to be 3000 [mm/s²] or less.

*2 Pushing force accuracy is ±20% (F.S.).

*3 The thrust setting values for LEY25□ are 38% to 65% and for LEY32□ are 38% to 85%. The pushing force values change according to the duty ratio and pushing speed. Check the "Model Selection" on page 915.

*4 The speed and force may change depending on the cable length, load, and mounting conditions. Furthermore, if the cable length exceeds 5 m, then it will decrease by up to 10% for each 5 m. (At 15 m: Reduced by up to 20%)

*5 The allowable speed for pushing operations. When push conveying a workpiece, operate at the vertical work load or less.

*6 A reference value for correcting errors in reciprocal operation

*7 Impact resistance: No malfunction occurred when the actuator was tested with a drop tester in both an axial direction and a perpendicular direction to the lead screw. (The test was performed with the actuator in the initial state.)

Vibration resistance: No malfunction occurred in a test ranging between 45 to 2000 Hz. The test was performed in both an axial direction and a perpendicular direction to the lead screw. (The test was performed with the actuator in the initial state.)

*8 Cannot be used in an environment where oil such as cutting oil splashes or it is constantly exposed to water

Take appropriate protective measures. For details on enclosure, refer to the "Enclosure" on page 881.

*9 Indicates the max. power during operation (including the controller). This value can be used for the selection of the power supply.

*10 With lock only

*11 For an actuator with lock, add the power for the lock.

*12 When mounting vertically and using the product facing upwards in an environment where water is present, take necessary measures to prevent water from splashing on the rod cover, because water will accumulate on the rod seal due to the structure of the product.

LEY-X5 Series

Incremental (Step Motor 24 VDC)

Incremental (Servo Motor 24 VDC)

Dust-tight/Water-jet-proof (IP65 Equivalent)

Specifications

Servo Motor (24 VDC)

Model		LEY25□A-X5			
Work load [kg]*1	Horizontal	(3000 [mm/s ²])	7	15	30
	Vertical*11	(3000 [mm/s ²])	2	5	11
Pushing force [N]*2 *3			18 to 35	37 to 72	66 to 130
Speed [mm/s]			2 to 400	1 to 200	1 to 100
Max. acceleration/deceleration [mm/s ²]			3000		
Pushing speed [mm/s]*4			35 or less		
Positioning repeatability [mm]			±0.02		
Lost motion [mm]*5			0.1 or less		
Screw lead [mm]			12	6	3
Impact/Vibration resistance [m/s ²]*6			50/20		
Actuation type			Ball screw + Belt (LEY□) Ball screw (LEY□D)		
Guide type			Sliding bushing (Piston rod)		
Enclosure*7			IP65 equivalent		
Operating temperature range [°C]			5 to 40		
Operating humidity range [%RH]			90 or less (No condensation)		
Motor size			□42		
Motor type			Servo motor (24 VDC)		
Encoder			Incremental		
Power supply voltage [V]			24 VDC ±10%		
Power [W]*8 *10			Max. power 96		
Type*9			Non-magnetizing lock		
Holding force [N]			78	157	294
Power [W]*10			5		
Rated voltage [V]			24 VDC ±10%		

- *1 Horizontal: The max. value of the work load. An external guide is necessary to support the load. (Friction coefficient of guide: 0.1 or less) The actual work load and transfer speed change according to the condition of the external guide. Vertical: Speed changes according to the work load. Check the "Model Selection" on page 914. The values shown in () are the acceleration/deceleration.
Set these values to be 3000 [mm/s²] or less.
- *2 Pushing force accuracy is ±20% (F.S.).
- *3 The thrust setting values for LEY25A□ are 75% to 95%. The pushing force values change according to the duty ratio and pushing speed. Check the "Model Selection" on page 915.
- *4 The allowable speed for pushing operations
When push conveying a workpiece, operate at the vertical work load or less.
- *5 A reference value for correcting errors in reciprocal operation
- *6 Impact resistance: No malfunction occurred when the actuator was tested with a drop tester in both an axial direction and a perpendicular direction to the lead screw. (The test was performed with the actuator in the initial state.)
Vibration resistance: No malfunction occurred in a test ranging between 45 to 2000 Hz. The test was performed in both an axial direction and a perpendicular direction to the lead screw. (The test was performed with the actuator in the initial state.)
- *7 Cannot be used in an environment where oil such as cutting oil splashes or it is constantly exposed to water
Take appropriate protective measures. For details on enclosure, refer to the "Enclosure" on page 881.
- *8 Indicates the max. power during operation (including the controller). This value can be used for the selection of the power supply.
- *9 With lock only
- *10 For an actuator with lock, add the power for the lock.
- *11 When mounting vertically and using the product facing upwards in an environment where water is present, take necessary measures to prevent water from splashing on the rod cover, because water will accumulate on the rod seal due to the structure of the product.

Weight

Weight: Top Side Parallel Motor Type

Model		LEY25-X5								LEY32-X5											
Stroke [mm]		30	50	100	150	200	250	300	350	400	30	50	100	150	200	250	300	350	400	450	500
Product weight [kg]	Step motor	1.45	1.52	1.69	1.95	2.13	2.30	2.48	2.65	2.83	2.48	2.59	2.88	3.35	3.64	3.91	4.21	4.49	4.76	5.04	5.32
	Servo motor	1.41	1.48	1.65	1.91	2.09	2.26	2.44	2.61	2.79	—	—	—	—	—	—	—	—	—	—	—

Weight: In-line Motor Type

Model		LEY25D-X5								LEY32D-X5											
Stroke [mm]		30	50	100	150	200	250	300	350	400	30	50	100	150	200	250	300	350	400	450	500
Product weight [kg]	Step motor	1.46	1.53	1.70	1.96	2.14	2.31	2.49	2.66	2.84	2.49	2.60	2.89	3.36	3.65	3.92	4.22	4.50	4.77	5.05	5.33
	Servo motor	1.42	1.49	1.66	1.92	2.10	2.27	2.45	2.62	2.80	—	—	—	—	—	—	—	—	—	—	—

Additional Weight

Size		25	32
Lock		0.33	0.63
Rod end male thread	Male thread	0.03	0.03
	Nut	0.02	0.02
Foot bracket (2 sets including mounting bolt)		0.08	0.14
Rod flange (including mounting bolt)		0.17	0.20
Head flange (including mounting bolt)			

Construction

Top side parallel motor type: LEY²⁵₃₂

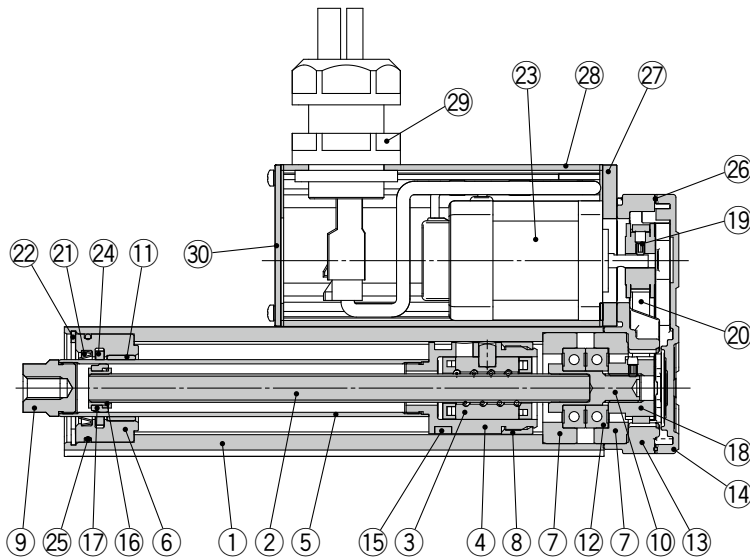

In-line motor type: LEY²⁵₃₂D

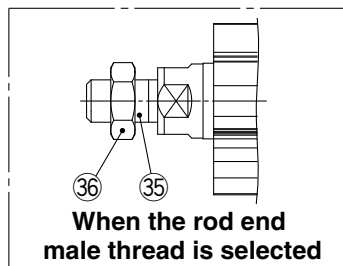
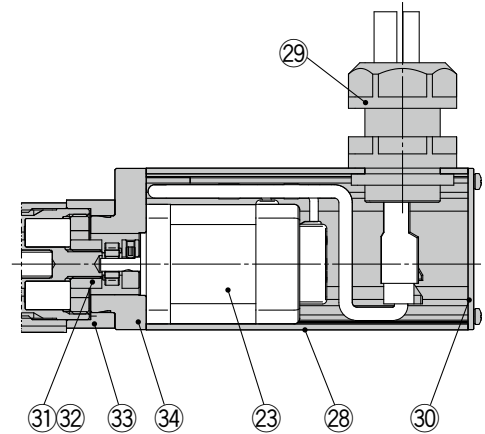

Component Parts

No.	Description	Material	Note
1	Body	Aluminum alloy	Anodized
2	Ball screw shaft	Alloy steel	
3	Ball screw nut	Synthetic resin/Alloy steel	
4	Piston	Aluminum alloy	
5	Piston rod	Stainless steel	Hard chrome plating
6	Rod cover	Aluminum alloy	
7	Bearing holder	Aluminum alloy	
8	Rotation stopper	Synthetic resin	
9	Socket	Free cutting carbon steel	Nickel plating
10	Connected shaft	Free cutting carbon steel	Nickel plating
11	Bushing	Bearing alloy	
12	Bearing	—	
13	Return box	Aluminum die-cast	Coating
14	Return plate	Aluminum die-cast	Coating
15	Magnet	—	
16	Wear ring holder	Stainless steel	Stroke 101 mm or more
17	Wear ring	Synthetic resin	Stroke 101 mm or more
18	Screw shaft pulley	Aluminum alloy	
19	Motor pulley	Aluminum alloy	

No.	Description	Material	Note
20	Belt	—	
21	Scraper	Synthetic resin	
22	Retaining ring	Steel for spring	Phosphate coating
23	Motor	—	
24	Lube-retainer	Felt	
25	O-ring	NBR	
26	Gasket	NBR	
27	Motor adapter	Aluminum alloy	Anodized
28	Motor cover	Aluminum alloy	Anodized
29	Seal connector	—	
30	End cover	Aluminum alloy	Anodized
31	Hub	Aluminum alloy	
32	Spider	NBR	
33	Motor block	Aluminum alloy	Anodized
34	Motor adapter	Aluminum alloy	LEY25 only
35	Socket (Male thread)	Free cutting carbon steel	Nickel plating
36	Nut	Alloy steel	Zinc chromating

Replacement Parts (Top side parallel only)/Belt

No.	Size	Order no.
20	25	LE-D-2-2
	32	LE-D-2-3

Replacement Parts/Grease Pack

Applied portion	Order no.
Piston rod	GR-S-010 (10 g)
	GR-S-020 (20 g)

* Apply grease to the piston rod periodically.
Grease should be applied when 1 million cycles or 200 km have been reached, whichever comes first.

LEY-X5 Series

Incremental (Step Motor 24 VDC)

Incremental (Servo Motor 24 VDC)

Dust-tight/Water-jet-proof (IP65 Equivalent)

Dimensions

Top side parallel motor type

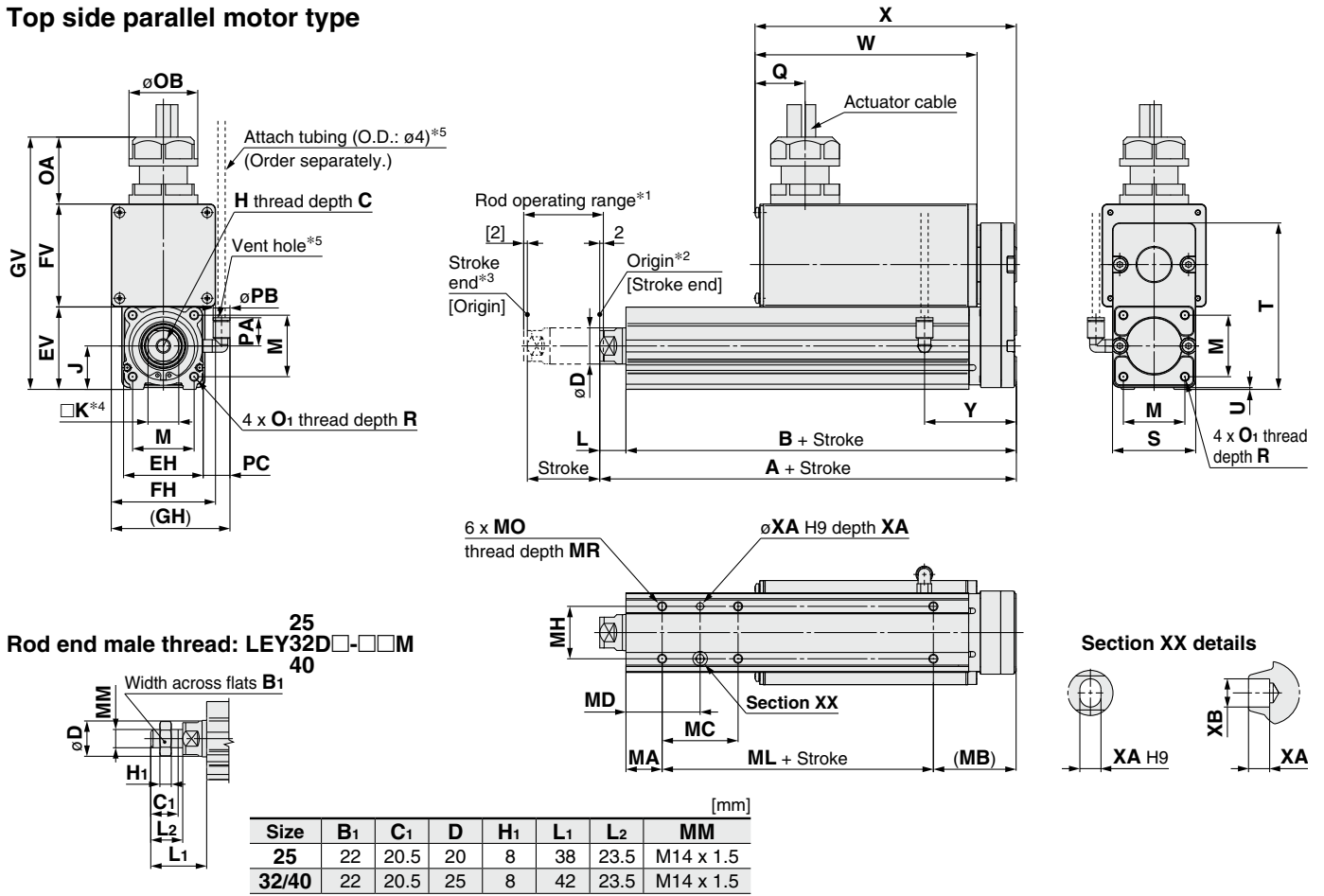

Size	B ₁	C ₁	D	H ₁	L ₁	L ₂	MM
25	22	20.5	20	8	38	23.5	M14 x 1.5
32/40	22	20.5	25	8	42	23.5	M14 x 1.5

* The L₁ measurement is when the unit is in the original position. At this position, 2 mm at the end.

Size	Stroke range [mm]	A	B	C	D	EH	EV	FH	FV	GH	GV	H	J	K	L	M	O ₁
25	15 to 100	130.5	116	13	20	44	45.5	57.6	56.8	66.2	139.5	M8 x 1.25	24	17	14.5	34	M5 x 0.8
	101 to 400	155.5	141														
32	20 to 100	148.5	130	13	25	51	56.5	69.6	78.6	76.2	173.5	M8 x 1.25	31	22	18.5	40	M6 x 1.0
	101 to 500	178.5	160														

Size	Stroke range [mm]	R	OA	OB	PA	PB	Q	S	T	U	PC	W		X		Y
												Without lock	With lock	Without lock	With lock	
25	15 to 100	8	37	38	15.4	8.2	28	46	92	1	15.4	123	173	145	195	51
	101 to 400											123	173	150	200	
32	20 to 100	10	37	38	15.4	8.2	28	60	118	1	15.9	123	173	150	200	61
	101 to 500											123	173	150	200	

Body Bottom Tapped

Size	Stroke range [mm]	MA	MB	MC	MD	MH	ML	MO	MR	XA	XB
25	15 to 39	20	46	24	32	29	50	M5 x 0.8	6.5	4	5
	40 to 100			42	41						
	101 to 124			59	49.5						
	125 to 200			76	58						
	201 to 400			76	58						
32	20 to 39	25	55	22	36	30	50	M6 x 1	8.5	5	6
	40 to 100			36	43						
	101 to 124			53	51.5						
	125 to 200			53	51.5						
	201 to 500			70	60						

*1 This is the range within which the rod can move when it returns to origin. Make sure that workpieces mounted on the rod do not interfere with other workpieces or the facilities around the rod.

*2 Position after returning to origin

*3 [] for when the direction of return to origin has changed

*4 The direction of rod end width across flats (□K) differs depending on the products.

*5 The vent hole is the port for releasing to atmosphere. Do not apply pressure to this hole.

Attach tubing to the vent hole and place the end of the tubing so it is not exposed to dust or water.

For the mounting bracket dimensions, refer to the **Web Catalog**.

Dimensions

In-line motor type

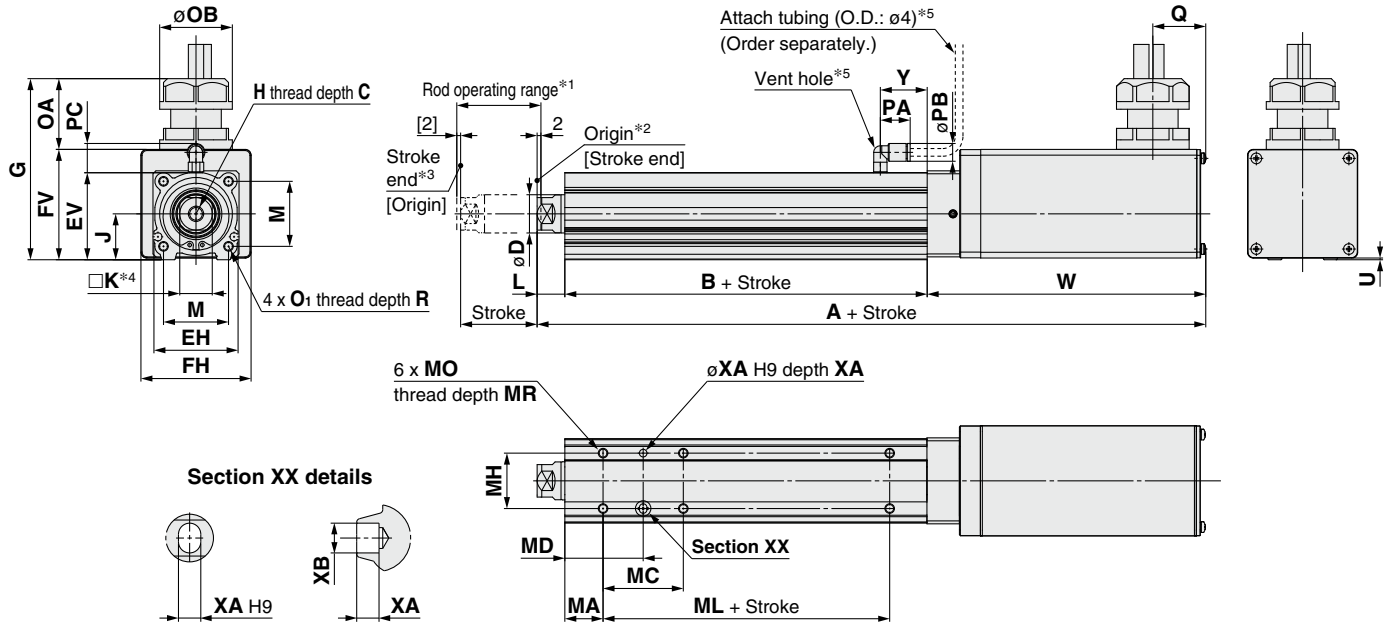

Size	Stroke range [mm]	A		B	C	D	EH	EV	FH	FV	G	H	J	K	L
		Without lock	With lock												
25	15 to 100	250	300	89.5	13	20	44	45.5	57.6	57.7	94.7	M8 x 1.25	24	17	14.5
	101 to 400	275	325	114.5											
32	20 to 100	265.5	315.5	96	13	25	51	56.5	69.6	79.6	116.6	M8 x 1.25	31	22	18.5
	101 to 500	295.5	345.5	126											

Size	Stroke range [mm]	M	O ₁	R	OA	OB	PA	PB	Q	U	PC	W		Y
												Without lock	With lock	
25	15 to 100	34	M5 x 0.8	8	37	38	15.4	8.2	28	0.9	15.9	146	196	24.5
	101 to 400											151	201	
32	20 to 100	40	M6 x 1.0	10	37	38	15.4	8.2	28	1	15.9	151	201	27
	101 to 500											151	201	

Body Bottom Tapped

Size	Stroke range [mm]	MA	MC	MD	MH	ML	MO	MR	XA	XB
25	15 to 39	20	24	32	29	50	M5 x 0.8	6.5	4	5
	40 to 100		42	41						
	101 to 124		59	49.5		75				
	125 to 200		76	58						
	201 to 400		76	58						
32	20 to 39	25	22	36	30	50	M6 x 1	8.5	5	6
	40 to 100		36	43						
	101 to 124		53	51.5		80				
	125 to 200		53	51.5						
	201 to 500		70	60						

*1 This is the range within which the rod can move when it returns to origin. Make sure that workpieces mounted on the rod do not interfere with other workpieces or the facilities around the rod.

*2 Position after returning to origin

*3 [] for when the direction of return to origin has changed

*4 The direction of rod end width across flats (□K) differs depending on the products.

*5 The vent hole is the port for releasing to atmosphere. Do not apply pressure to this hole.

Attach tubing to the vent hole and place the end of the tubing so it is not exposed to dust or water.

For the rod end male thread, refer to page 923.
For the mounting bracket dimensions, refer to the **Web Catalog**.

Rod Type Dust-tight/Water-jet-proof (IP65 Equivalent)

LEY-X5 (Made to Order) Series LEY25, 32

Refer to page 433 for model selection.

Size 63 is available by selecting option P. Refer to page 473.

LEY Series ▶ p. 931



How to Order

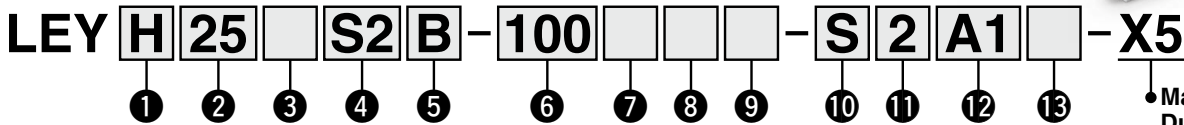

• Made to order:
Dust-tight/
Water-jet-proof

① Accuracy

Nil	Basic type
H	High-precision type

② Size

25
32

③ Motor mounting position

Nil	Top side parallel
D	In-line

④ Motor type

Symbol	Type	Output [W]	② Size	⑫ Driver type	Compatible drivers
S2*1	AC servo motor (Incremental encoder)	100	25	A1/A2	LECSA□-S1
S3		200	32	A1/A2	LECSA□-S3
T6*2	AC servo motor (Absolute encoder)	100	25	B2	LECSB2-T5
				C2	LECSS2-T5
T7		200	32	B2	LECSB2-T7
				C2	LECSS2-T7

*1 For motor type S2, the compatible driver part number suffix is S1.

*2 For motor type T6, the compatible driver part number is LECS□2-T5.

⑤ Lead [mm]

Symbol	LEY25□	LEY32□*1
A	12	16 (20)
B	6	8 (10)
C	3	4 (5)

*1 The values shown in () are the equivalent leads which include the pulley ratio for the size 32 top side parallel motor type.

⑥ Stroke [mm]

30	30
to	to
500	500

* For details, refer to the applicable stroke table below.

⑦ Motor option

Nil	Without option
B	With lock*1

*1 When "With lock" is selected for the top side parallel motor type, the motor body will stick out from the end of the body for size 25 with strokes of 30 mm or less. Check for interference with workpieces before selecting a model.

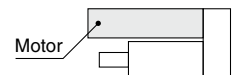

⑧ Rod end thread

Nil	Rod end female thread
M	Rod end male thread (1 rod end nut is included.)

⑨ Mounting*1

Symbol	Type	Motor mounting position	
		Parallel	In-line
Nil	Ends tapped/ Body bottom tapped*2	●	●
L	Foot bracket	●	—
F	Rod flange*2	●*3	●
G	Head flange*2	●*4	—

*1 The mounting bracket is shipped together with the product but does not come assembled.

*2 For the horizontal cantilever mounting of the rod flange, head flange, or ends tapped types, use the actuator within the following stroke range.

- LEY25: 200 mm or less
- LEY32: 100 mm or less

*3 The rod flange type is not available for the LEY25 with a 30 mm stroke and motor option "With lock."

*4 The head flange type is not available for the LEY32.

Applicable Stroke Table

Model	Stroke	30	50	100	150	200	250	300	350	400	450	500	Manufacturable stroke range [mm]
		●	●	●	●	●	●	●	●	●	●	●	
LEY25		●	●	●	●	●	●	●	●	●	—	—	15 to 400
LEY32		●	●	●	●	●	●	●	●	●	●	●	20 to 500

* Please contact SMC for non-standard strokes as they are produced as special orders.

* For auto switches, refer to pages 936 and 937.

10 Cable type*1 *2

Nil	Without cable
S	Standard cable
R	Robotic cable

*1 A motor cable and encoder cable are included with the product. (A lock cable is also included if motor option "B: With lock" is selected.)

*2 Standard cable entry direction is
 • Top side parallel: (A) Axis side
 • In-line: (B) Counter axis side
 (Refer to page 1123 for details.)

11 Cable length [m]*1

Nil	Without cable
2	2
5	5
A	10

*1 The length of the encoder, motor, and lock cables are the same.

12 Driver type*1

	Compatible drivers	Power supply voltage [V]
Nil	Without driver	—
A1	LECSA1-S□	100 to 120
A2	LECSA2-S□	200 to 230
B2	LECSB2-T□	200 to 240
C2	LECSC2-T□	200 to 230
S2	LECSS2-T□	200 to 240

*1 When a driver type is selected, a cable is included. Select the cable type and cable length.

Example)

S2S2: Standard cable (2 m) + Driver (LECSS2)

S2: Standard cable (2 m)





Nil: Without cable and driver

13 I/O cable length [m]*1

Nil	Without cable
H	Without cable (Connector only)
1	1.5

*1 When "Nil: Without driver" is selected for the driver type, only "Nil: Without cable" can be selected. Refer to page 1124 if an I/O cable is required. (Options are shown on page 1124.)

Compatible Drivers

Driver type	Pulse input type/ Positioning type	Pulse input type	CC-Link direct input type	SSCNET III/H type
				
Series	LECSA	LECSB-T	LECSC-T	LECSS-T
Number of point tables	Up to 7	Up to 255	Up to 255 (2 stations occupied)	—
Pulse input	○	○	—	—
Applicable network	—	—	CC-Link	SSCNET III/H
Control encoder	Incremental 17-bit encoder	Absolute 22-bit encoder	Absolute 18-bit encoder	Absolute 22-bit encoder
Communication function	USB communication	USB communication, RS422 communication	USB communication, RS422 communication	USB communication
Power supply voltage [V]	100 to 120 VAC (50/60 Hz) 200 to 230 VAC (50/60 Hz)	200 to 240 VAC (50/60 Hz)	200 to 240 VAC (50/60 Hz)	200 to 240 VAC (50/60 Hz)
Reference page	1109			

LEY-X5 Series

AC Servo Motor

Dust-tight/Water-jet-proof (IP65 Equivalent)

Specifications: LECSA

Model		LEY25S2/T6-X5 /LEY25DS2/T6-X5			LEY32S3/T7-X5 (Parallel)			LEY32DS3/T7-X5 (In-line)				
Actuator specifications	Work load [kg]	Horizontal*1		18	50	50	30	60	60	30	60	60
		Vertical*8		8	16	30	9	19	37	12	24	46
	Force [N]*2 (Set value: 15 to 30%)*12		65 to 131	127 to 255	242 to 485	79 to 157	154 to 308	294 to 588	98 to 197	192 to 385	368 to 736	
	Max. speed [mm/s]*3	Stroke range	Up to 300	900	450	225	1200	600	300	1000	500	250
			305 to 400	600	300	150	800	400	200	640	320	160
			405 to 500	—	—	—	—	—	—	—	—	—
	Pushing speed [mm/s]*4		35 or less			30 or less			30 or less			
	Max. acceleration/deceleration [mm/s ²]		5000			5000			5000			
	Positioning repeatability [mm]	Basic type					±0.02					
		High-precision type					±0.01					
	Lost motion [mm]*5	Basic type					0.1 or less					
		High-precision type					0.05 or less					
	Lead [mm] (including pulley ratio)		12	6	3	20	10	5	16	8	4	
	Impact/Vibration resistance [m/s ²]*6		50/20			50/20			50/20			
	Actuation type		Ball screw + Belt/Ball screw			Ball screw + Belt [1.25:1]			Ball screw			
Guide type		Sliding bushing (Piston rod)			Sliding bushing (Piston rod)			Sliding bushing (Piston rod)				
Enclosure*7					IP65 equivalent							
Operating temperature range [°C]		5 to 40			5 to 40			5 to 40				
Operating humidity range [%RH]		90 or less (No condensation)			90 or less (No condensation)			90 or less (No condensation)				
Regeneration option		May be required depending on speed and work load (Refer to pages 435 and 436.)			May be required depending on speed and work load (Refer to pages 435 and 436.)			May be required depending on speed and work load (Refer to pages 435 and 436.)				
Motor output/Size		100 W/□40			200 W/□60			200 W/□60				
Motor type		AC servo motor (100/200 VAC)			AC servo motor (100/200 VAC)			AC servo motor (100/200 VAC)				
Encoder*11		Motor type S2, S3: Incremental 17-bit encoder (Resolution: 131072 p/rev) Motor type T6, T7: Absolute 22-bit encoder (Resolution: 4194304 p/rev) (For LECSB-T□, LECSS-T□) Motor type T6, T7: Absolute 18-bit encoder (Resolution: 262144 p/rev) (For LECSC-T□)			Motor type S2, S3: Incremental 17-bit encoder (Resolution: 131072 p/rev) Motor type T6, T7: Absolute 22-bit encoder (Resolution: 4194304 p/rev) (For LECSB-T□, LECSS-T□) Motor type T6, T7: Absolute 18-bit encoder (Resolution: 262144 p/rev) (For LECSC-T□)			Motor type S2, S3: Incremental 17-bit encoder (Resolution: 131072 p/rev) Motor type T6, T7: Absolute 22-bit encoder (Resolution: 4194304 p/rev) (For LECSB-T□, LECSS-T□) Motor type T6, T7: Absolute 18-bit encoder (Resolution: 262144 p/rev) (For LECSC-T□)				
Power [W]*9		Max. power 445			Max. power 724			Max. power 724				
Type*10		Non-magnetizing lock			Non-magnetizing lock			Non-magnetizing lock				
Holding force [N]		131	255	485	157	308	588	197	385	736		
Power at 20°C [W]		6.3			7.9			7.9				
Rated voltage [V]		24 VDC			24 VDC			24 VDC				

- *1 This is the max. value of the horizontal work load. An external guide is necessary to support the load (Friction coefficient of guide: 0.1 or less). The actual work load changes according to the condition of the external guide. Confirm the load using the actual device.
- *2 The force setting range (set values for the driver) for the force control with the torque control mode. Set it while referencing the "Force Conversion Graph" on pages 437 and 438. The drivers applicable to the pushing operation are "LECSB-T" and "LECSS-T." The LECSB2-T is only applicable when the control method is positioning. The point table is used to set the pushing operation settings. To set the pushing operation settings, an additional dedicated file (pushing operation extension file) must be downloaded separately to be used with the setup software (MR Configurator2™: LEC-MRC2□). Please download this dedicated file from the SMC website: <https://www.smcworld.com> When selecting the LECSS or LECSS2-T, combine it with upper level equipment (such as the Simple Motion module manufactured by Mitsubishi Electric Corporation) which has a pushing operation function.
- ** For customer-provided PLC and motion controller setting and usage instructions, confirm with the retailer or manufacturer.
- *3 The allowable speed changes according to the stroke.
- *4 The allowable collision speed for collision with the workpiece with the torque control mode
- *5 A reference value for correcting errors in reciprocal operation

- *6 Impact resistance: No malfunction occurred when the actuator was tested with a drop tester in both an axial direction and a perpendicular direction to the lead screw. (The test was performed with the actuator in the initial state.)
Vibration resistance: No malfunction occurred in a test ranging between 45 to 2000 Hz. The test was performed in both an axial direction and a perpendicular direction to the lead screw. (The test was performed with the actuator in the initial state.)
- *7 Cannot be used in an environment where oil such as cutting oil splashes or it is constantly exposed to water
Take appropriate protective measures. For details on enclosure, refer to the "Enclosure" on page 881.
- *8 When mounting vertically and using the product facing upwards in an environment where water is present, take necessary measures to prevent water from splashing on the rod cover, because water will accumulate on the rod seal due to the structure of the product.
- *9 Indicates the max. power during operation (including the driver)
When selecting the power supply capacity, refer to the power supply capacity in the operation manual of each driver.
- *10 Only when motor option "With lock" is selected
- *11 The resolution will change depending on the driver type.
- *12 For motor type T6 and T7, the set value is from 12 to 24%.

Weight

Product Weight

Series		LEY25S2/T6-X5 (Motor mounting position: Parallel)									LEY32S3/T7-X5 (Motor mounting position: Parallel)										
Stroke [mm]		30	50	100	150	200	250	300	350	400	30	50	100	150	200	250	300	350	400	450	500
Motor type	Incremental encoder	1.31	1.38	1.55	1.81	1.99	2.16	2.34	2.51	2.69	2.42	2.53	2.82	3.29	3.57	3.85	4.14	4.42	4.70	4.98	5.26
	Absolute encoder	T6/T7	1.4	1.5	1.6	1.9	2.0	2.2	2.4	2.6	2.7	2.3	2.4	2.7	3.2	3.5	3.8	4.1	4.3	4.6	4.9

Series		LEY25DS2/T6-X5 (Motor mounting position: In-line)									LEY32DS3/T7-X5 (Motor mounting position: In-line)										
Stroke [mm]		30	50	100	150	200	250	300	350	400	30	50	100	150	200	250	300	350	400	450	500
Motor type	Incremental encoder	1.34	1.41	1.58	1.84	2.02	2.19	2.37	2.54	2.72	2.44	2.55	2.84	3.31	3.59	3.87	4.16	4.44	4.72	5.00	5.28
	Absolute encoder	T6/T7	1.4	1.5	1.6	1.9	2.1	2.2	2.4	2.6	2.8	2.4	2.5	2.8	3.2	3.5	3.8	4.1	4.4	4.6	4.9

Additional Weight

Size		25	32
Lock	Incremental encoder	0.20	0.40
	Absolute encoder	0.30	0.66
Rod end male thread	Male thread	0.03	0.03
	Nut	0.02	0.02
Foot bracket (2 sets including mounting bolt)		0.08	0.14
Rod flange (including mounting bolt)		0.17	0.20
Head flange (including mounting bolt)			
Double clevis (including pin, retaining ring, and mounting bolt)		0.16	0.22

Construction

Top side parallel motor type: **LEY²⁵₃₂**

In-line motor type: **LEY²⁵₃₂D**

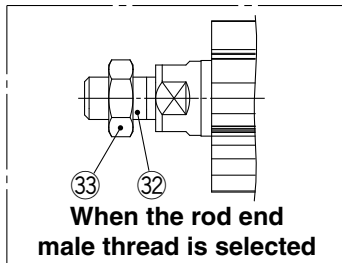
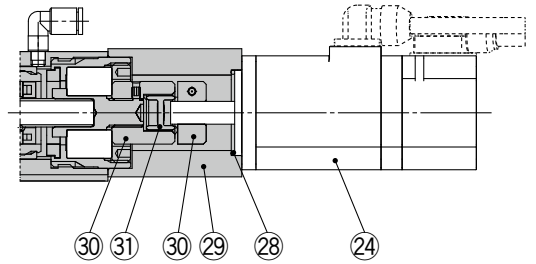
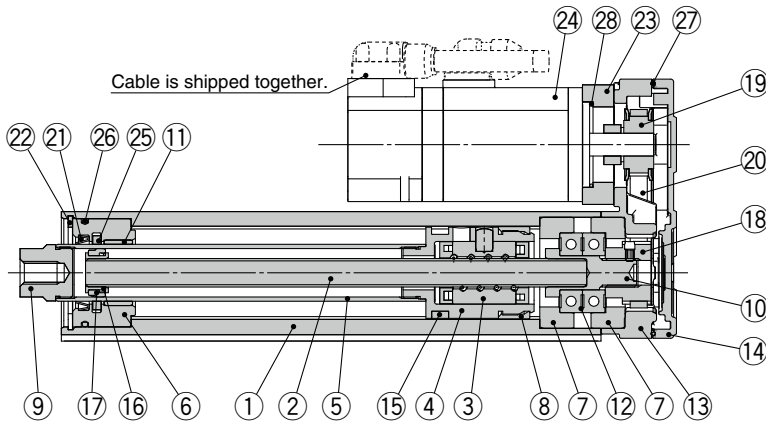

Component Parts

No.	Description	Material	Note
1	Body	Aluminum alloy	Anodized
2	Ball screw shaft	Alloy steel	
3	Ball screw nut	Synthetic resin/Alloy steel	
4	Piston	Aluminum alloy	
5	Piston rod	Stainless steel	Hard chrome plating
6	Rod cover	Aluminum alloy	
7	Bearing holder	Aluminum alloy	
8	Rotation stopper	Synthetic resin	
9	Socket	Free cutting carbon steel	Nickel plating
10	Connected shaft	Free cutting carbon steel	Nickel plating
11	Bushing	Bearing alloy	
12	Bearing	—	
13	Return box	Aluminum die-cast	Coating
14	Return plate	Aluminum die-cast	Coating
15	Magnet	—	
16	Wear ring holder	Stainless steel	Stroke 101 mm or more
17	Wear ring	Synthetic resin	Stroke 101 mm or more

No.	Description	Material	Note
18	Screw shaft pulley	Aluminum alloy	
19	Motor pulley	Aluminum alloy	
20	Belt	—	
21	Scraper	Synthetic resin	
22	Retaining ring	Steel for spring	Phosphate coating
23	Motor adapter	Aluminum alloy	Coating
24	Motor	—	
25	Lube-retainer	Felt	
26	O-ring	NBR	
27	Gasket	NBR	
28	O-ring	NBR	
29	Motor block	Aluminum alloy	Coating
30	Hub	Aluminum alloy	
31	Spider	Urethane	
32	Socket (Male thread)	Free cutting carbon steel	Nickel plating
33	Nut	Alloy steel	Trivalent chromating

Replacement Parts (Top side parallel only)/Belt

No.	Size	Order no.
20	25	LE-D-2-2
	32	LE-D-2-4

Replacement Parts/Grease Pack

Applied portion	Order no.
Piston rod	GR-S-010 (10 g)
	GR-S-020 (20 g)

* Apply grease to the piston rod periodically.
Grease should be applied when 1 million cycles or 200 km have been reached, whichever comes first.

LEY-X5 Series

AC Servo Motor

Dust-tight/Water-jet-proof (IP65 Equivalent)

Dimensions

Top side parallel motor type: LEY₂₅²⁵

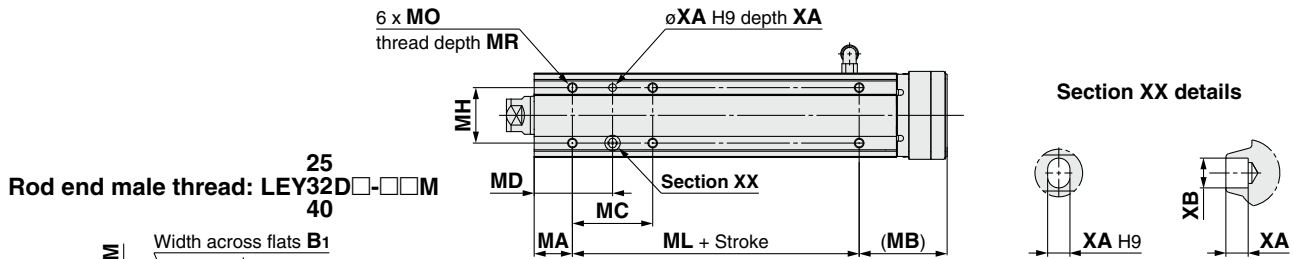
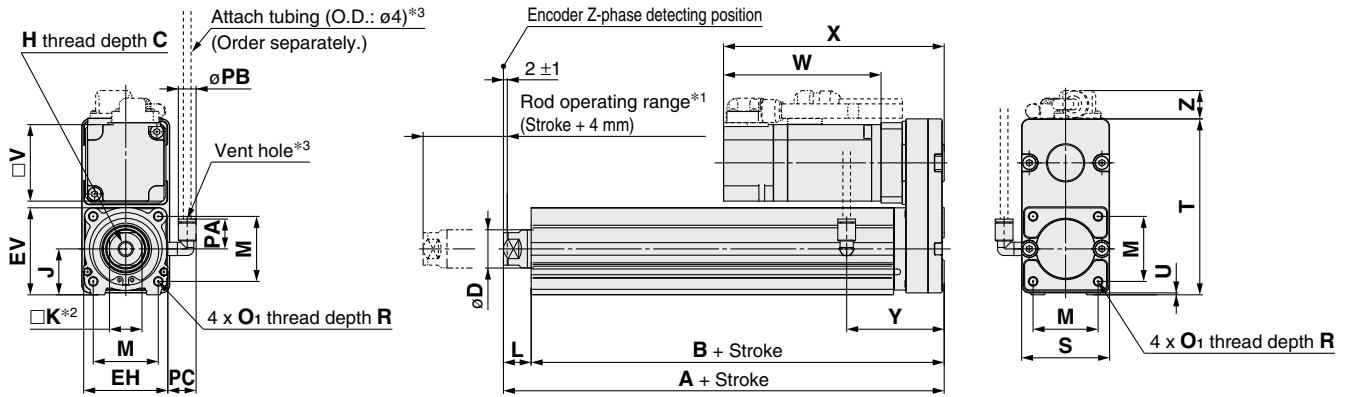

	[mm]						
Size	B ₁	C ₁	D	H ₁	L ₁	L ₂	MM
25	22	20.5	20	8	38	23.5	M14 x 1.5
32/40	22	20.5	25	8	42	23.5	M14 x 1.5

* The L₁ measurement is when the unit is in the original position. At this position, 2 mm at the end.

Size	Stroke range [mm]	[mm]																		
		A	B	C	D	EH	EV	H	J	K	L	M	O ₁	R	PA	PB	V	S	T	U
25	15 to 100	130.5	116	13	20	44	45.5	M8 x 1.25	24	17	14.5	34	M5 x 0.8	8	15.4	8.2	40	46	92	1
	101 to 400	155.5	141																	
32	20 to 100	148.5	130	13	25	51	56.5	M8 x 1.25	31	22	18.5	40	M6 x 1.0	10	15.4	8.2	60	60	118	1
	101 to 500	178.5	160																	

Size	Stroke range [mm]	PC	Incremental encoder [S2/S3]						Absolute encoder [T6/T7]						Y
			Without lock			With lock			Without lock			With lock			
			W	X	Z	W	X	Z	W	X	Z	W	X	Z	
25	15 to 100	15.4	87	120	14.1	123.9	156.9	15.8	82.4	115.4	14.1	123	156	15.8	51
	101 to 400														
32	20 to 100	15.9	88.2	128.2	17.1	116.8	156.8	17.1	76.6	116.6	17.1	113.4	153.4	17.1	61
	101 to 500														

Body Bottom Tapped

Size	Stroke range [mm]	MA	MB	MC	MD	MH	ML	MO	MR	XA	XB
25	15 to 39	20	46	24	32	29	50	M5 x 0.8	6.5	4	5
	40 to 100			42	41		75				
	101 to 124			59	49.5						
	125 to 200			76	58						
	201 to 400			76	58						
32	20 to 39	25	55	22	36	30	50	M6 x 1	8.5	5	6
	40 to 100			36	43		80				
	101 to 124			53	51.5						
	125 to 200			70	60						

*1 This is the range within which the rod can move. Make sure that workpieces mounted on the rod do not interfere with other workpieces or the facilities around the rod.

*2 The direction of rod end width across flats (□K) differs depending on the products.

*3 The vent hole is the port for releasing to atmosphere. Do not apply pressure to this hole.

Attach tubing to the vent hole and place the end of the tubing so it is not exposed to dust or water.

For the mounting bracket dimensions, refer to the **Web Catalog**.

Dimensions

In-line motor type: LEY²⁵/₃₂D

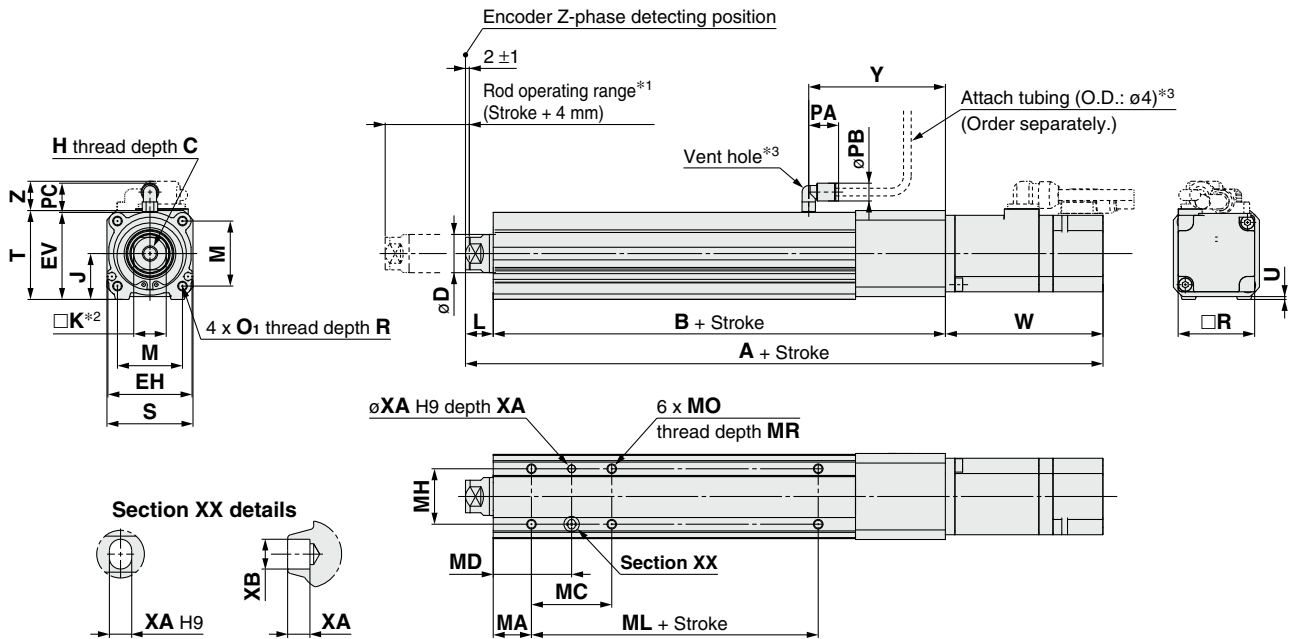

Size	Stroke range [mm]	Incremental encoder [S2/S6]						Absolute encoder [T6/T7]						B	C	D	EH	EV
		Without lock			With lock			Without lock			With lock							
		A	W	Z	A	W	Z	A	VB	VC	A	VB	VC					
25	15 to 100	238	87	14.6	274.9	123.9	16.3	233.4	82.4	14.6	274	123	16.3	136.5	13	20	44	45.5
	101 to 400	263			299.9			258.4			299			161.5				
32	20 to 100	262.7	88.2	17.1	291.3	116.8	17.1	251.1	76.6	17.1	287.9	113.4	17.1	156	13	25	51	56.5
	101 to 500	292.7			321.3			281.1			317.9			186				

Size	Stroke range [mm]	H	J	K	L	M	O ₁	R	PA	PB	V	S	T	U	PC	Y
25	15 to 100	M8 x 1.25	24	17	14.5	34	M5 x 0.8	8	15.4	8.2	40	45	46.5	1.5	15.9	71.5
	101 to 400	M8 x 1.25	24	17	14.5	34	M5 x 0.8	8	15.4	8.2	40	45	46.5	1.5	15.9	71.5
32	20 to 100	M8 x 1.25	31	22	18.5	40	M6 x 1.0	10	15.4	8.2	60	60	61	1	15.9	87
	101 to 500	M8 x 1.25	31	22	18.5	40	M6 x 1.0	10	15.4	8.2	60	60	61	1	15.9	87

Body Bottom Tapped

Size	Stroke range [mm]	MA	MC	MD	MH	ML	MO	MR	XA	XB
25	15 to 39	20	24	32	29	50	M5 x 0.8	6.5	4	5
	40 to 100		42	41		75				
	101 to 124		59	49.5						
	125 to 200		76	58						
	201 to 400		76	58						
32	20 to 39	25	22	36	30	50	M6 x 1	8.5	5	6
	40 to 100		36	43		80				
	101 to 124		53	51.5						
	125 to 200		70	60						
	201 to 500		70	60						

*¹ This is the range within which the rod can move. Make sure that workpieces mounted on the rod do not interfere with other workpieces or the facilities around the rod.

*² The direction of rod end width across flats (□K) differs depending on the products.

*³ The vent hole is the port for releasing to atmosphere. Do not apply pressure to this hole.

Attach tubing to the vent hole and place the end of the tubing so it is not exposed to dust or water.

For the rod end male thread, refer to page 929. For the mounting bracket dimensions, refer to the **Web Catalog**.

Rod Type Dust-tight/Water-jet-proof (IP65 Equivalent)

LEY-X5 (Made to Order) Series LEY25, 32

Refer to page 411 for model selection.

Size 63 is available by selecting option P. Refer to page 489.

LECS Series ▶ p. 925

How to Order



LEY **H** **25** **V6** **B** - **200** **S** **3** **M2** - **X5**

①
②
③
④
⑤
⑥
⑦
⑧
⑨
⑩
⑪
⑫
⑬

• Made to order:
Dust-tight/
Water-jet-proof

① Accuracy

Nil	Basic type
H	High-precision type

② Size

25
32

③ Motor mounting position

Nil	Top side parallel
D	In-line

④ Motor type

Symbol	Type	Output [W]	② Size	⑫ Driver type	Compatible drivers
V6 *1	AC servo motor (Absolute encoder)	100	25	M2	LECYM2-V5
				U2	LECYU2-V5
V7		200	32	M2	LECYM2-V7
				U2	LECYU2-V7

*1 For motor type V6, the compatible driver part number suffix is V5.

⑤ Lead [mm]

Symbol	LEY25	LEY32
A	12	16 (20)
B	6	8 (10)
C	3	4 (5)

* The values shown in () are the leads for the top side parallel motor type. (Equivalent leads which include the pulley ratio [1.25:1])

⑥ Stroke [mm]

30	30
to	to
500	500

* For details, refer to the applicable stroke table below.

⑦ Motor option

Nil	Without option
B	With lock

* When "With lock" is selected for the top side parallel motor type, the motor body will stick out from the end of the body for size 25 with strokes of 30 mm or less. Check for interference with workpieces before selecting a model.

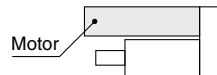

⑧ Rod end thread

Nil	Rod end female thread
M	Rod end male thread (1 rod end nut is included.)

Applicable Stroke Table

●: Standard

Model	Stroke [mm]	30	50	100	150	200	250	300	350	400	450	500	Manufacturable stroke range
LEY25		●	●	●	●	●	●	●	●	●	—	—	15 to 400
LEY32		●	●	●	●	●	●	●	●	●	●	●	20 to 500

* Please contact SMC for non-standard strokes as they are produced as special orders.

For auto switches, refer to pages 936 and 937.

9 Mounting*1

Symbol	Type	Motor mounting position	
		Parallel	In-line
Nil	Ends tapped/ Body bottom tapped*2	●	●
L	Foot bracket	●	—
F	Rod flange*2	●*3	●
G	Head flange*2	●*4	—

- *1 The mounting bracket is shipped together with the product but does not come assembled.
- *2 For the horizontal cantilever mounting of the ends tapped, rod flange, or head flange types, use the actuator within the following stroke range.
 · LEY25: 200 mm or less · LEY32: 100 mm or less
- *3 The rod flange type is not available for the LEY25 with a 30 mm stroke and motor option "With lock."
- *4 The head flange type is not available for the LEY32.

10 Cable type*1

Nil	Without cable
S	Standard cable
R	Robotic cable

- *1 A motor cable and encoder cable are included with the product.
 The motor cable for lock option is included when the motor with lock option is selected.

11 Cable length [m]*1

Nil	Without cable
3	3
5	5
A	10
C	20

- *1 The length of the motor and encoder cables are the same. (For with lock)

12 Driver type

	Compatible drivers	Power supply voltage [V]
Nil	Without driver	—
M2	LECYM2-V□	200 to 230
U2	LECYU2-V□	200 to 230

- * When a driver type is selected, a cable is included. Select the cable type and cable length.

13 I/O cable length [m]*1

Nil	Without cable
H	Without cable (Connector only)
1	1.5

- *1 When "Nil: Without driver" is selected for the driver type, only "Nil: Without cable" can be selected.
 Refer to page 1135 if an I/O cable is required.
 (Options are shown on page 1135.)

Compatible Drivers

Driver type	■ MECHATROLINK-II type	■ MECHATROLINK-III type
		
Series	LECYM	LECYU
Applicable network	MECHATROLINK-II	MECHATROLINK-III
Control encoder	Absolute 20-bit encoder	
Communication device	USB communication, RS-422 communication	
Power supply voltage [V]	200 to 230 VAC (50/60 Hz)	
Reference page	1128	

LEY-X5 Series

AC Servo Motor

Dust-tight/Water-jet-proof (IP65 Equivalent)

Specifications: LECY

Model			LEY25V6-X5/LEY25DV6-X5				LEY32V7-X5 (Parallel)			LEY32DV7-X5 (In-line)		
Work load [kg]	Horizontal ^{*1}		18	50	50	30	60	60	30	60	60	
	Vertical ^{*9}		8	16	30	9	19	37	12	24	46	
Force [N] ^{*2} (Set value: 45 to 90%)			65 to 131	127 to 255	242 to 485	79 to 157	154 to 308	294 to 588	98 to 197	192 to 385	368 to 736	
Max. speed [mm/s] ^{*3}	Stroke range	Up to 300	900	450	225	1200	600	300	1000	500	250	
		305 to 400	600	300	150							
		405 to 500	—	—	—	800	400	200	640	320	160	
Pushing speed [mm/s] ^{*4}			35 or less			30 or less			30 or less			
Max. acceleration/deceleration [mm/s ²]			5000			5000			5000			
Positioning repeatability [mm]	Basic type		±0.02			±0.02			±0.02			
	High-precision type		±0.01			±0.01			±0.01			
Lost motion [mm] ^{*5}	Basic type		0.1 or less			0.1 or less			0.1 or less			
	High-precision type		0.05 or less			0.05 or less			0.05 or less			
Lead [mm] (including pulley ratio)			12	6	3	20 ^{*6}	10 ^{*6}	5 ^{*6}	16	8	4	
Impact/Vibration resistance [m/s ²] ^{*7}			50/20			50/20			50/20			
Actuation type			Ball screw + Belt (LEY□)/Ball screw (LEY□)			Ball screw + Belt [1.25:1]			Ball screw			
Guide type			Sliding bushing (Piston rod)			Sliding bushing (Piston rod)			Sliding bushing (Piston rod)			
Enclosure ^{*8}						IP65 equivalent						
Operating temperature range [°C]			5 to 40			5 to 40			5 to 40			
Operating humidity range [%RH]			90 or less (No condensation)			90 or less (No condensation)			90 or less (No condensation)			
Required conditions for the regenerative resistor ^{*10} [kg]	Horizontal		Not required			Not required			Not required			
	Vertical		6 or more			4 or more			4 or more			
Motor output/Size			100 W/□40			200 W/□60			200 W/□60			
Motor type			AC servo motor (200 VAC)			AC servo motor (200 VAC)			AC servo motor (200 VAC)			
Encoder			Absolute 20-bit encoder (Resolution: 1048576 p/rev)			Absolute 20-bit encoder (Resolution: 1048576 p/rev)			Absolute 20-bit encoder (Resolution: 1048576 p/rev)			
Power [W] ^{*11}	Type ^{*12}		Max. power 445			Max. power 724			Max. power 724			
			Non-magnetizing lock			Non-magnetizing lock			Non-magnetizing lock			
Holding force [N]			131	255	485	157	308	588	197	385	736	
Power at 20°C [W]			5.5			6			6			
Rated voltage [V]						24 VDC ^{+10%} ₀						

- *1 This is the max. value of the horizontal work load. An external guide is necessary to support the load (Friction coefficient of guide: 0.1 or less). The actual work load changes according to the condition of the external guide. Confirm the load using the actual device.
- *2 The force setting range (set values for the driver) for the force control with the torque control mode
Set it while referencing the "Force Conversion Graph (Guide)" on page 445.
- *3 The allowable speed changes according to the stroke.
- *4 The allowable collision speed for collision with the workpiece with the torque control mode
- *5 A reference value for correcting errors in reciprocal operation
- *6 Equivalent leads which include the pulley ratio [1.25:1]
- *7 Impact resistance: No malfunction occurred when the actuator was tested with a drop tester in both an axial direction and a perpendicular direction to the lead screw. (The test was performed with the actuator in the initial state.)
Vibration resistance: No malfunction occurred in a test ranging between 45 to 2000 Hz. The test was performed in both an axial direction and a perpendicular direction to the lead screw. (The test was performed with the actuator in the initial state.)

- *8 Cannot be used in an environment where oil such as cutting oil splashes or it is constantly exposed to water
Take appropriate protective measures. For details on enclosure, refer to the "Enclosure" on page 881.
- *9 When mounting vertically and using the product facing upwards in an environment where water is present, take necessary measures to prevent water from splashing on the rod cover, because water will accumulate on the rod seal due to the structure of the product.
- *10 The work load conditions which require the regenerative resistor when operating at the max. speed (Duty ratio: 100%). Order the regenerative resistor separately. For details, refer to the "Required Conditions for the Regenerative Resistor (Guide)" on pages 443 and 444.
- *11 Indicates the max. power during operation (including the driver)
When selecting the power supply capacity, refer to the power supply capacity in the operation manual of each driver.
- *12 Only when motor option "With lock" is selected

Weight

Product Weight

Series	LEY25V6 (Motor mounting position: Parallel)										LEY32V7 (Motor mounting position: Parallel)									
Stroke [mm]	30	50	100	150	200	250	300	350	400	30	50	100	150	200	250	300	350	400	450	500
Weight [kg]	1.2	1.3	1.6	1.7	1.9	2.1	2.2	2.4	2.6	2.3	2.4	2.7	3.2	3.5	3.8	4.0	4.3	4.6	4.9	5.2

Series	LEY25DV6 (Motor mounting position: In-line)										LEY32DV7 (Motor mounting position: In-line)									
Stroke [mm]	30	50	100	150	200	250	300	350	400	30	50	100	150	200	250	300	350	400	450	500
Weight [kg]	1.2	1.3	1.5	1.7	1.9	2.1	2.3	2.4	2.6	2.3	2.4	2.7	3.2	3.5	3.8	4.1	4.3	4.6	4.9	5.2

Additional Weight

Size		25	32
Lock		0.30	0.60
Rod end male thread	Male thread	0.03	0.03
	Nut	0.02	0.02
Foot bracket (2 sets including mounting bolt)		0.08	0.14
Rod flange (including mounting bolt)		0.17	0.20
Head flange (including mounting bolt)			

Dimensions

Top side parallel motor type: LEY₃₂²⁵

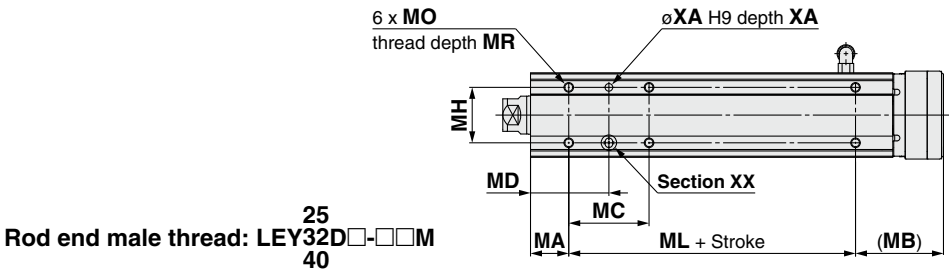
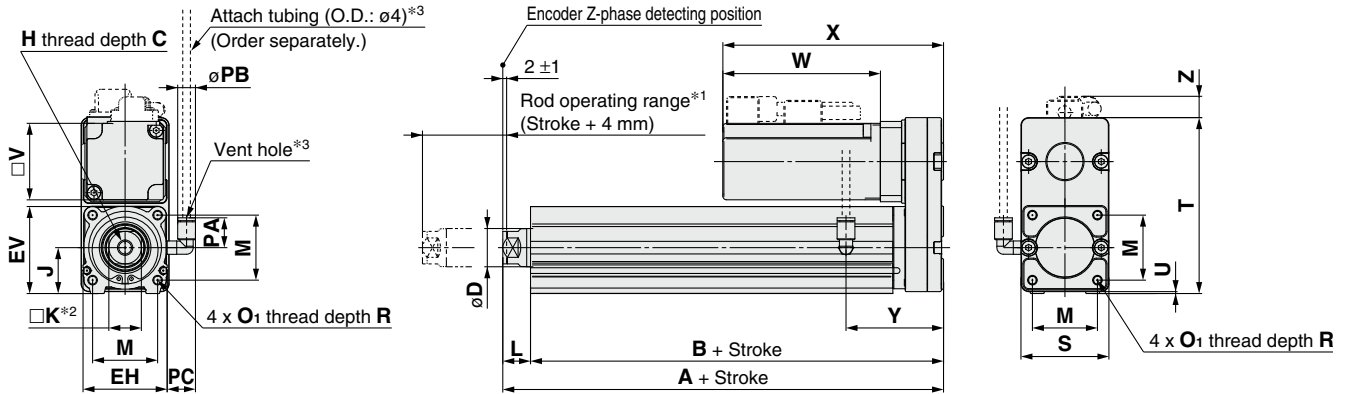

Section XX details

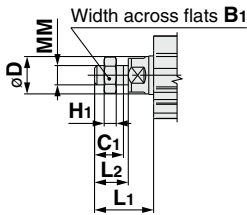
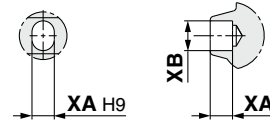

Size	B ₁	C ₁	D	H ₁	L ₁	L ₂	MM
25	22	20.5	20	8	38	23.5	M14 x 1.5
32/40	22	20.5	25	8	42	23.5	M14 x 1.5

* The L₁ measurement is when the unit is in the original position. At this position, 2 mm at the end.

Size	Stroke range [mm]	A	B	C	D	EH	EV	H	J	K	L	M	O ₁	R	PA	PB	V
25	15 to 100	130.5	116	13	20	44	45.5	M8 x 1.25	24	17	14.5	34	M5 x 0.8	8	15.4	8.2	40
	101 to 400	155.5	141														
32	20 to 100	148.5	130	13	25	51	56.5	M8 x 1.25	31	22	18.5	40	M6 x 1.0	10	15.4	8.2	60
	101 to 500	178.5	160														

Size	Stroke range [mm]	S	T	U	PC	Without lock			With lock			Y
						W	X	Z	W	X	Z	
25	15 to 100	46	92	1	15.4	82.5	115.5	11	127.5	160.5	11	51
	101 to 400											
32	20 to 100	60	118	1	15.9	80	120	14	120	160	14	61
	101 to 500											

Body Bottom Tapped

Size	Stroke range [mm]	MA	MB	MC	MD	MH	ML	MO	MR	XA	XB
25	15 to 39	20	46	24	32	29	50	M5 x 0.8	6.5	4	5
	40 to 100			42	41						
	101 to 124			59	49.5		75				
	125 to 200			76	58						
	201 to 400			76	58						
32	20 to 39	25	55	22	36	30	50	M6 x 1	8.5	5	6
	40 to 100			36	43						
	101 to 124			53	51.5		80				
	125 to 200			53	51.5						
	201 to 500			70	60						

*1 This is the range within which the rod can move. Make sure that workpieces mounted on the rod do not interfere with other workpieces or the facilities around the rod.

*2 The direction of rod end width across flats (□K) differs depending on the products.

*3 The vent hole is the port for releasing to atmosphere. Do not apply pressure to this hole.

Attach tubing to the vent hole and place the end of the tubing so it is not exposed to dust or water.

For the mounting bracket dimensions, refer to the **Web Catalog**.

LEY-X5 Series

AC Servo Motor

Dust-tight/Water-jet-proof (IP65 Equivalent)

Dimensions

In-line motor type: LEY²⁵₃₂D

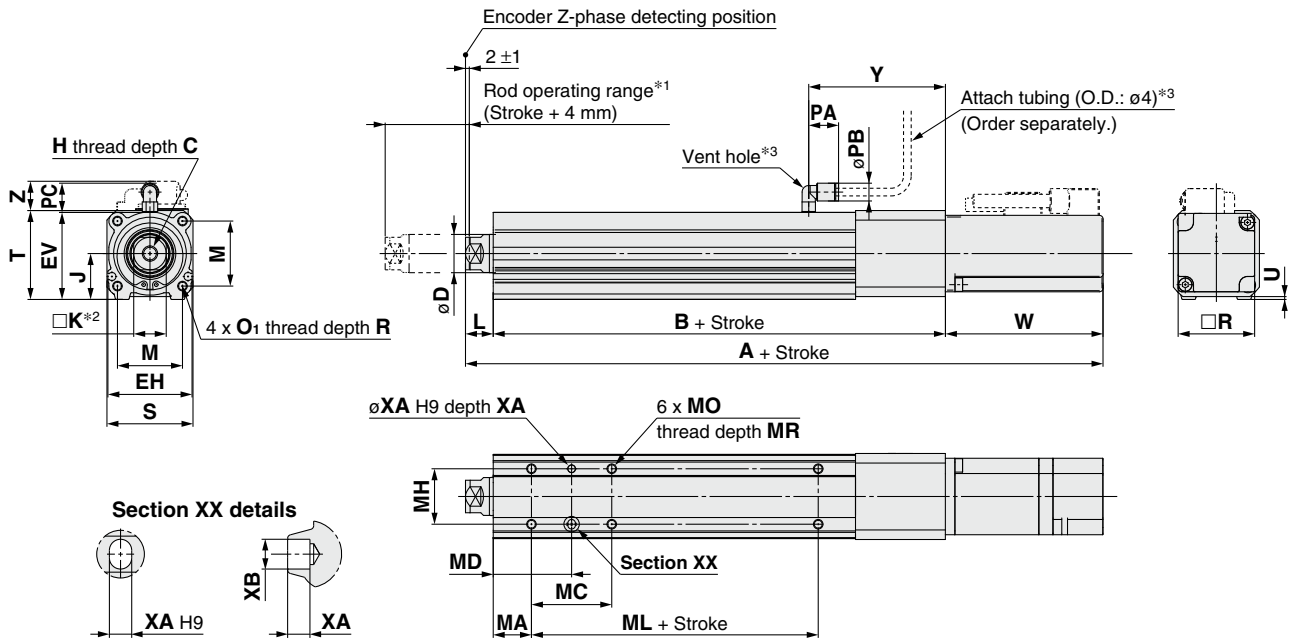

[mm]

Size	Stroke range [mm]	Without lock			With lock			B	C	D	EH	EV
		A	W	Z	A	W	Z					
25	15 to 100	233.5	82.5	11.5	278.5	127.5	11.5	136.5	13	20	44	45.5
	101 to 400	258.5			303.5			161.5				
32	20 to 100	254.5	80	14	294.5	120	14	156	13	25	51	56.5
	101 to 500	284.5			324.5			186				

Size	Stroke range [mm]	H	J	K	L	M	O ₁	R	PA	PB	V	S	T	U	PC	Y
25	15 to 100	M8 x 1.25	24	17	14.5	34	M5 x 0.8	8	15.4	8.2	40	45	46.5	1.5	15.9	71.5
	101 to 400															
32	20 to 100	M8 x 1.25	31	22	18.5	40	M6 x 1.0	10	15.4	8.2	60	60	61	1	15.9	87
	101 to 500															

Body Bottom Tapped

[mm]

Size	Stroke range [mm]	MA	MC	MD	MH	ML	MO	MR	XA	XB
25	15 to 39	20	24	32	29	50	M5 x 0.8	6.5	4	5
	40 to 100		42	41		75				
	101 to 124		59	49.5						
	125 to 200		76	58						
	201 to 400		76	58						
32	20 to 39	25	22	36	30	50	M6 x 1	8.5	5	6
	40 to 100		36	43		80				
	101 to 124		53	51.5						
	125 to 200		70	60						
	201 to 500		70	60						

*1 This is the range within which the rod can move. Make sure that workpieces mounted on the rod do not interfere with other workpieces or the facilities around the rod.

*2 The direction of rod end width across flats (□K) differs depending on the products.

*3 The vent hole is the port for releasing to atmosphere. Do not apply pressure to this hole.

Attach tubing to the vent hole and place the end of the tubing so it is not exposed to dust or water.

For the rod end male thread, refer to page 934.
For the mounting bracket dimensions, refer to the **Web Catalog**.

LEY-X5 Series Auto Switch Mounting

Auto Switch Proper Mounting Position

Applicable auto switch: D-M9□A(V)

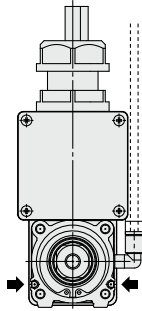

LEY25, 32

➔ Switch mounting groove

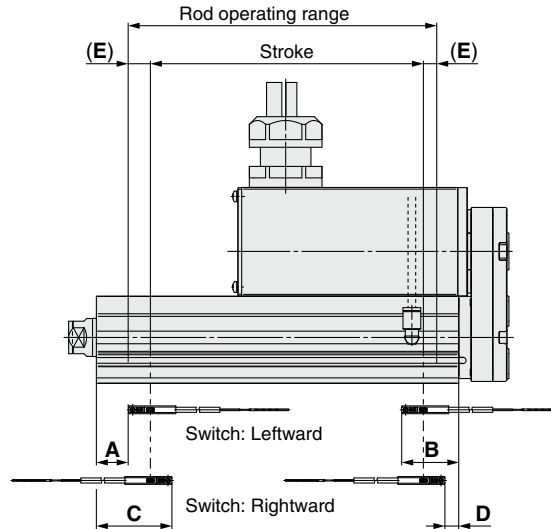

Size	Stroke range	Auto switch position				Return to origin distance	Operating range
		Leftward mounting		Rightward mounting			
		A	B	C	D		
25	15 to 100	27	62.5	39	50.5	(2)	4.2
	105 to 400	52		64			
32	20 to 100	30.5	85.5	42.5	53.5	(2)	4.9
	105 to 500	90.5		102.5			

- * The values in the table above are to be used as a reference when mounting auto switches for stroke end detection. Adjust the auto switch after confirming the operating conditions in the actual setting.
- * An auto switch cannot be mounted on the same side as a motor.
- * For LEYG series models (with a guide), an auto switch cannot be mounted on the guide attachment side (rod side).
- * Since the operating range is provided as a guideline including hysteresis, it cannot be guaranteed (assuming approx. $\pm 30\%$ dispersion). It may change substantially depending on the ambient environment.

Auto Switch Mounting

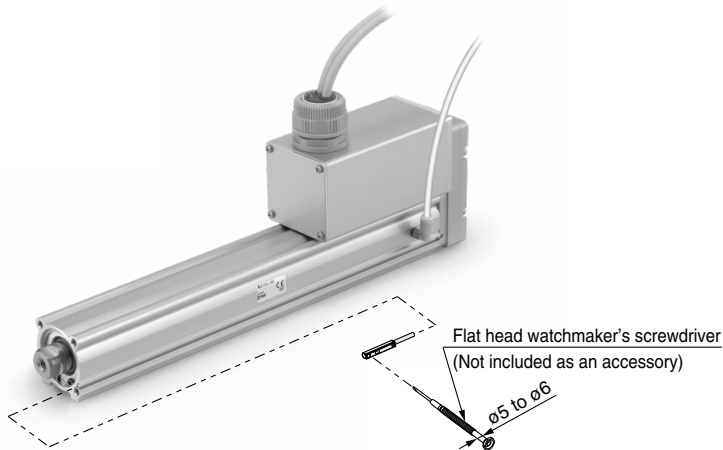

Tightening Torque for Auto Switch Mounting Screw [N·m]

Auto switch model	Tightening torque
D-M9□A(V)	0.05 to 0.10

- * When tightening the auto switch mounting screw (included with the auto switch), use a watchmaker's screwdriver with a handle diameter of 5 to 6 mm.

Water Resistant 2-Color Indicator Solid State Auto Switch: Direct Mounting Type D-M9NA(V)/D-M9PA(V)/D-M9BA(V)

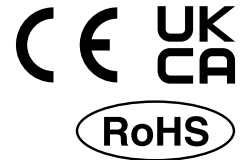

Grommet

- Water (coolant) resistant type
- 2-wire load current is reduced (2.5 to 40 mA).
- The proper operating range can be determined by the color of the light. (Red → Green ← Red)
- Using flexible cable as standard spec.

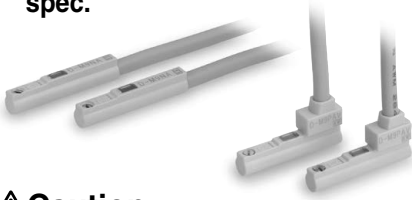

Caution

Precautions

Fix the auto switch with the existing screw installed on the auto switch body. The auto switch may be damaged if a screw other than the one supplied is used. Please contact SMC if using coolant liquid other than water based solution.

Weight

[g]

Auto switch model	D-M9NA(V)	D-M9PA(V)	D-M9BA(V)
Lead wire length			
0.5 m (Nil)	8	13	7
1 m (M)	14	21	13
3 m (L)	41	49	38
5 m (Z)	68	76	63

Dimensions

[mm]

D-M9□A

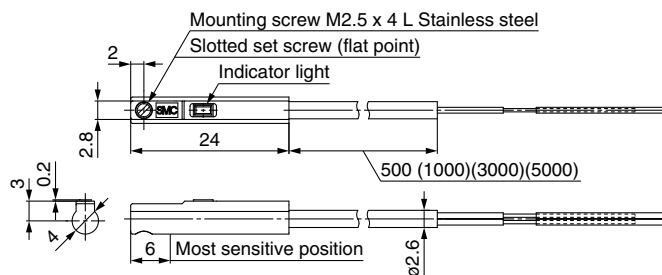

D-M9□AV

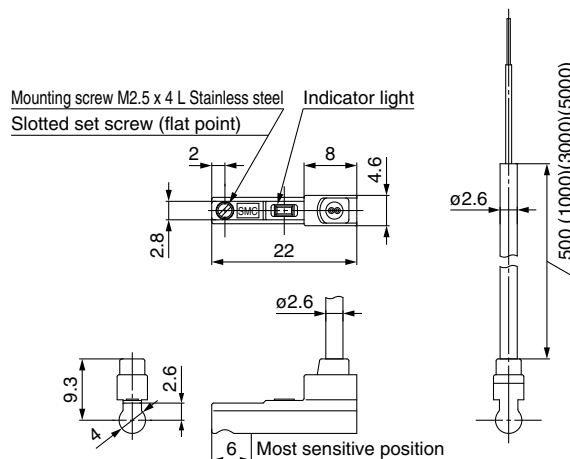

Auto Switch Specifications

PLC: Programmable Logic Controller

D-M9□A, D-M9□AV (With indicator light)						
Auto switch model	D-M9NA	D-M9NAV	D-M9PA	D-M9PAV	D-M9BA	D-M9BAV
Electrical entry direction	In-line	Perpendicular	In-line	Perpendicular	In-line	Perpendicular
Wiring type	3-wire				2-wire	
Output type	NPN		PNP		—	
Applicable load	IC circuit, Relay, PLC				24 VDC relay, PLC	
Power supply voltage	5, 12, 24 VDC (4.5 to 28 V)				—	
Current consumption	10 mA or less				—	
Load voltage	28 VDC or less		—		24 VDC (10 to 28 VDC)	
Load current	40 mA or less				2.5 to 40 mA	
Internal voltage drop	0.8 V or less at 10 mA (2 V or less at 40 mA)				4 V or less	
Leakage current	100 μA or less at 24 VDC				0.8 mA or less	
Indicator light	Operating range Red LED illuminates. Proper operating range Green LED illuminates.					
Standard	CE/UKCA marking					

Oilproof Flexible Heavy-duty Lead Wire Specifications

Auto switch model		D-M9NA□	D-M9NAV□	D-M9PA□	D-M9PAV□	D-M9BA□	D-M9BAV□
Sheath	Outside diameter [mm]	ø2.6					
Insulator	Number of cores	3 cores (Brown/Blue/Black)				2 cores (Brown/Blue)	
	Outside diameter [mm]	ø0.88					
Conductor	Effective area [mm ²]	0.15					
	Strand diameter [mm]	ø0.05					
Min. bending radius [mm]		17					

* Refer to page 1363 for solid state auto switch common specifications.

* Refer to page 1363 for lead wire lengths.