

High Rigidity Slider Type

LEJ Series

CE UK CA C RA US
* For details, refer to page 1343 and onward.

RoHS

Size: 40, 63

Low-profile/Low center of gravity

Height dimension: **58 mm**



LEJS40

AC Servo Motor

Ball Screw Drive *LEJS Series*

Size: 40, 63 ▶ p. 289, 303

Work load: **85 kg**

Positioning repeatability: ± 0.01 mm (High-precision type)

Max. speed: **1800 mm/s**

Max. acceleration/deceleration: **20000 mm/s²**

*1 ISO14644-1

*2 The particle generation characteristics change depending on the suction flow rate.

Clean Room Specification ▶ p. 289, 303

11-LEJS
ISO Class 4*1 *2

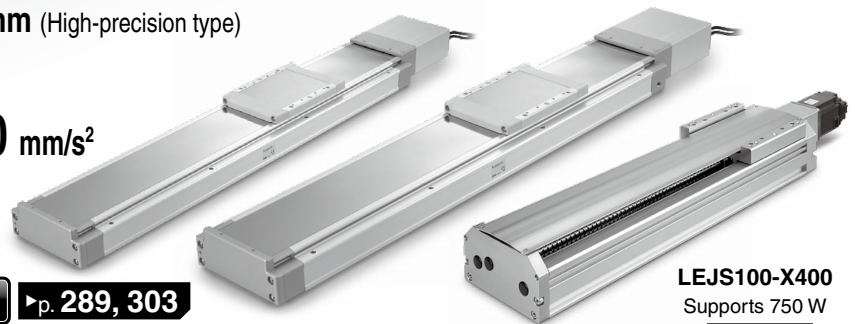

LEJS100-X400
Supports 750 W
▶ p. 300

Belt Drive *LEJB Series*

Size: 40, 63 ▶ p. 289, 303

Max. stroke: **3000 mm**

Max. speed: **3000 mm/s**

Max. acceleration/deceleration: **20000 mm/s²**

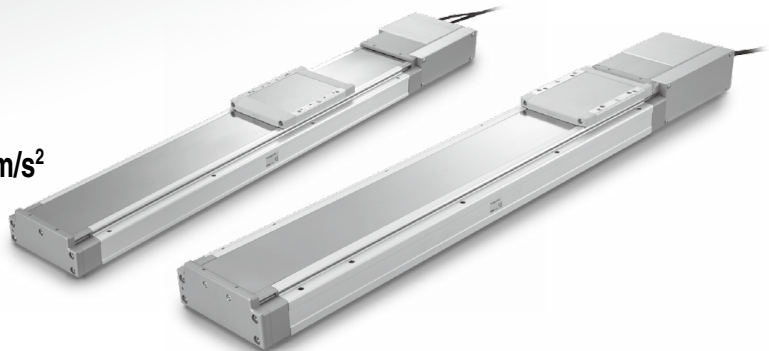

AC Servo Motor Drivers ▶ p. 1100

▶ For incremental encoders

- Pulse input type/
Positioning type
LECSA Series



▶ For absolute encoders

- Pulse input type/Positioning
LECSB-T Series
- CC-Link direct input type
LECSA-T Series
- SSCNET III/H type
LECSS-T Series
- MECHATROLINK type
LECY□ Series



High Rigidity Slider Type *LEJ Series*

●High precision/High rigidity

Double axis linear guide reduces deflection

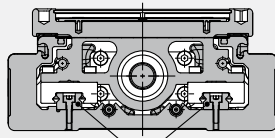

Linear guide (Double axis)

Table displacement

* LEJ□63: L = 64.5 mm

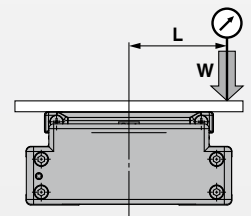
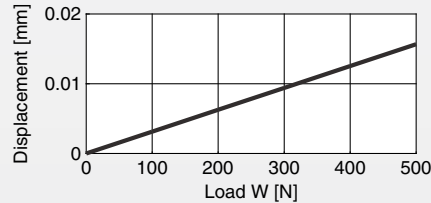

●Reduction in installation labor

It is possible to mount the main body without removing the external cover, etc.

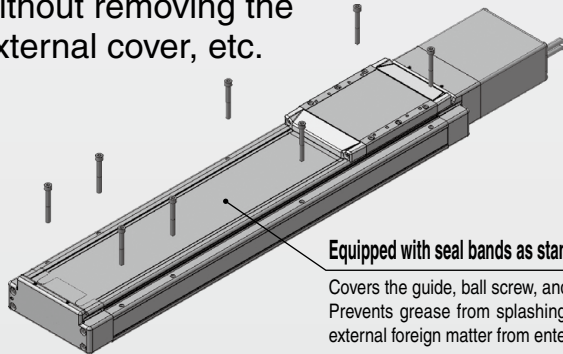

Equipped with seal bands as standard

Covers the guide, ball screw, and belt
Prevents grease from splashing and external foreign matter from entering

●Workpiece does not interfere with the motor.

Table height > Motor height

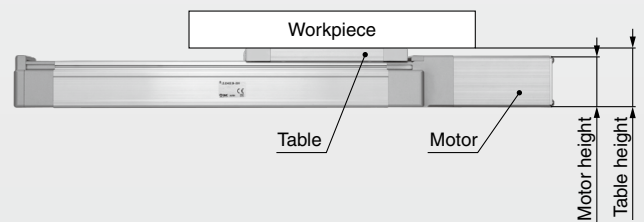

●Solid state auto switch can be mounted.

(For checking the limit and the intermediate signal)

- Switch wiring can be placed in the body
- A contact and B contact types available
- D-M9□W (2-color indicator), D-M9□, D-M9□E (B contact type)

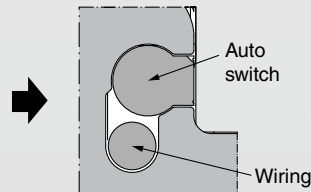

2-color indicator solid state auto switch

Appropriate setting of the mounting position can be performed without mistakes.

A green light lights up at the optimum operating range.

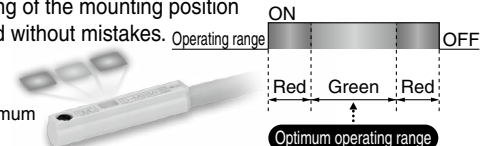

Application Examples

For pick and place operations

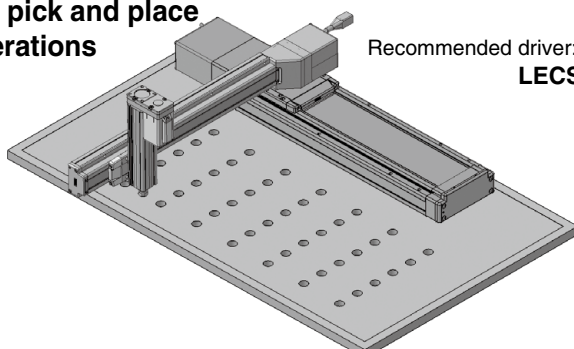

Recommended driver:
LECS□

For glue dispensing/High speed trajectory is available

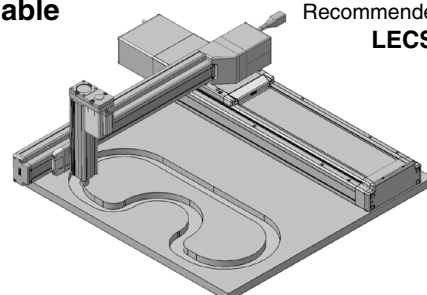

Recommended driver:
LECSS (SSCNET III)

Ball Screw Drive/*LEJS* Series

Model	Lead [mm]			Max. speed [mm/s]
LEJS40	24	16	8	1800 (Lead 24)
LEJS63	30	20	10	1800 (Lead 30)

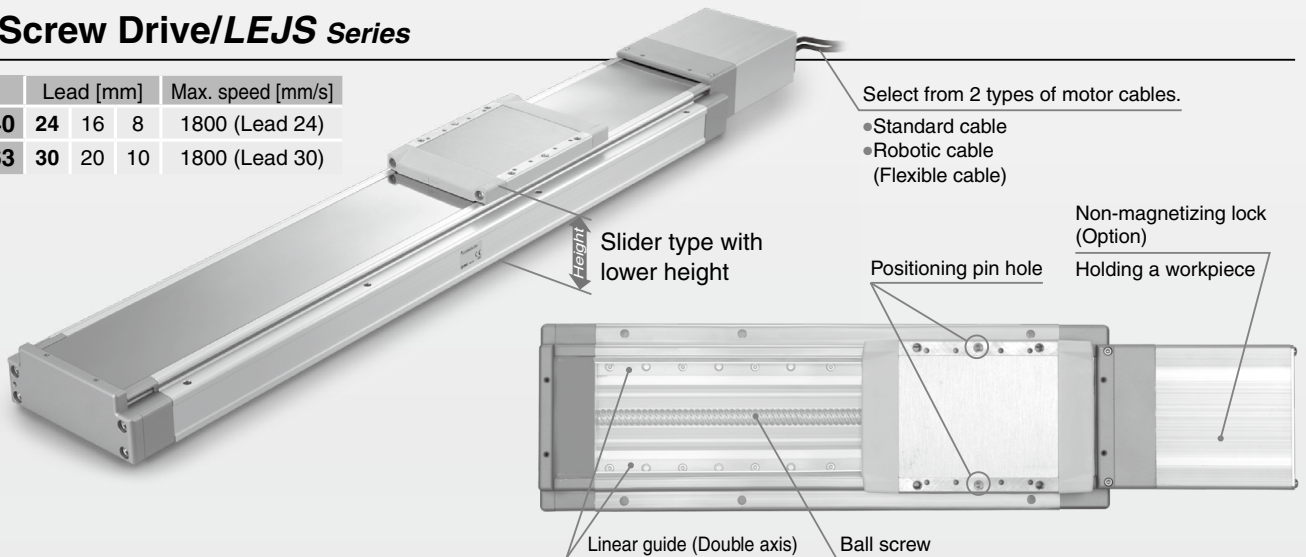

Built-in Intermediate Supports Type

Ball Screw Drive *LEJS63*□-□*M* Series

A maximum speed of 1800 mm/s* has been achieved throughout the entire stroke

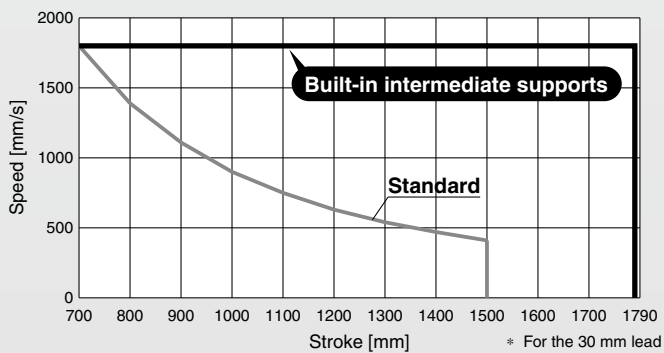

The use of intermediate supports results in reduced deflection of the ball screw when a long stroke is used.

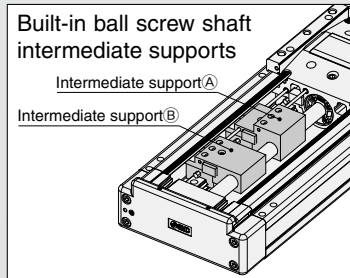

Clean Room Specification

Ball Screw Drive *11-LEJS* Series Size: 40, 63

ISO Class 4*1 *2

- Built-in vacuum piping
- It is possible to mount the main body without removing the external cover, etc.

*1 ISO14644-1
*2 The particle generation characteristics change depending on the suction flow rate. Refer to page 966 for details.

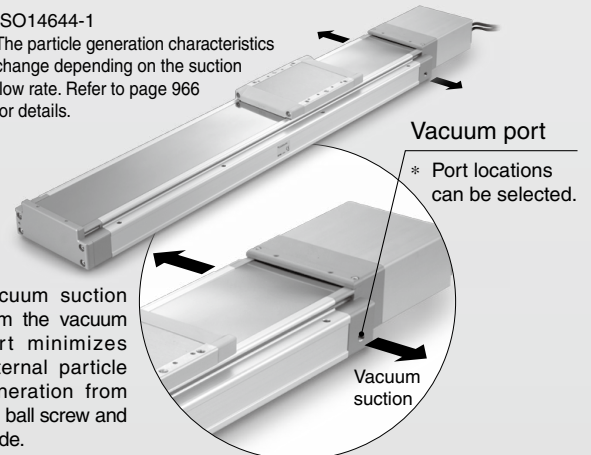

Vacuum suction from the vacuum port minimizes external particle generation from the ball screw and guide.

Ball Screw Drive *LEJS100-X400* Series

Supports 750 W (Motor output)

- Work load*1 Horizontal: 400 kg, Vertical: 80 kg
- Speed*2 Horizontal/Vertical: 2300 mm/s

*1 Speed: 500 mm/s, Lead: 10 mm
*2 Stroke: 800 mm, Lead: 50 mm

Max. acceleration/deceleration:
10000 mm/s²



Belt Drive/*LEJB* Series



High Rigidity Slider Type *LEJ Series*

Series Variations

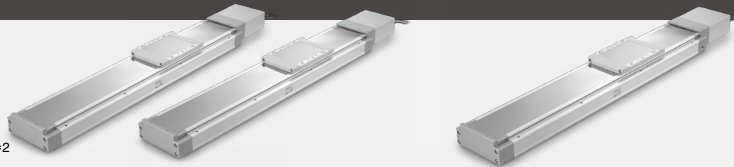

Ball Screw Drive/*LEJS Series* Clean room compatible *2

Size	Lead [mm]	Stroke [mm]*1	Work load: Horizontal [kg]							Work load: Vertical [kg]			Speed [mm/s]							Page
			10	20	30	40	50	60	70	80	90	10	20	30	200	400	600	800	1000	
40	8	200, 300, 400	[Bar chart showing horizontal load capacity]							[Bar chart showing vertical load capacity]			[Bar chart showing speed capacity]							289, 303
	16	500, 600, 700 800, 900	[Bar chart showing horizontal load capacity]							[Bar chart showing vertical load capacity]			[Bar chart showing speed capacity]							
	24	1000, 1200	[Bar chart showing horizontal load capacity]							[Bar chart showing vertical load capacity]			[Bar chart showing speed capacity]							
63	10	300, 400, 500	[Bar chart showing horizontal load capacity]							[Bar chart showing vertical load capacity]			[Bar chart showing speed capacity]							
	20	600, 700, 800 900, 1000	[Bar chart showing horizontal load capacity]							[Bar chart showing vertical load capacity]			[Bar chart showing speed capacity]							
	30	1200, 1500	[Bar chart showing horizontal load capacity]							[Bar chart showing vertical load capacity]			[Bar chart showing speed capacity]							

*1 Please contact SMC for non-standard strokes as they are produced as special orders.

*2 Excludes 24 and 30 mm leads

Built-in Intermediate Supports Type

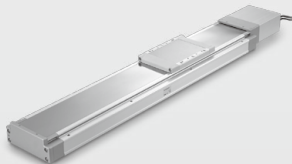

Ball Screw Drive/*LEJS-M Series*

Size	Lead [mm]	Stroke [mm]*1	Work load: Horizontal [kg]							Work load: Vertical [kg]			Speed [mm/s]							Page
			10	20	30	40	50	60	70	80	90	10	20	30	200	400	600	800	1000	
63	10	790, 890, 990 1190, 1490, 1790	[Bar chart showing horizontal load capacity]							[Bar chart showing vertical load capacity]			[Bar chart showing speed capacity]							289, 303
	20		[Bar chart showing horizontal load capacity]							[Bar chart showing vertical load capacity]			[Bar chart showing speed capacity]							
	30		[Bar chart showing horizontal load capacity]							[Bar chart showing vertical load capacity]			[Bar chart showing speed capacity]							

*1 Please contact SMC for non-standard strokes as they are produced as special orders.

Ball Screw Drive/*LEJS-X400 Series*

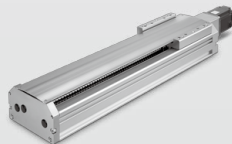

Size	Lead [mm]	Stroke [mm]*1	Work load: Horizontal [kg]			Work load: Vertical [kg]			Speed [mm/s]							Page
			100	200	400	20	40	80	500	750	1000	1250	1500	1750	2000	
100	10	200, 300, 400	[Bar chart showing horizontal load capacity]			[Bar chart showing vertical load capacity]			[Bar chart showing speed capacity]							300
	25	500, 600, 800 1000, 1200	[Bar chart showing horizontal load capacity]			[Bar chart showing vertical load capacity]			[Bar chart showing speed capacity]							
	50	1500	[Bar chart showing horizontal load capacity]			[Bar chart showing vertical load capacity]			[Bar chart showing speed capacity]							

*1 Please contact SMC for non-standard strokes as they are produced as special orders.

Belt Drive/*LEJB Series*

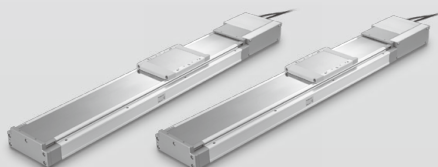

Size	Equivalent lead [mm]	Stroke [mm]*1	Work load: Horizontal [kg]*2						Speed [mm/s]					Page
			5	10	15	20	25	30	500	1000	1500	2000	2500	
40	27	200, 300, 400, 500, 600, 700, 800 900, 1000, 1200, 1500, 2000	[Bar chart showing horizontal load capacity]						[Bar chart showing speed capacity]					289, 303
63	42	300, 400, 500, 600, 700, 800 900, 1000, 1200, 1500, 2000, 3000	[Bar chart showing horizontal load capacity]						[Bar chart showing speed capacity]					

*1 Please contact SMC for non-standard strokes as they are produced as special orders.

*2 The belt drive actuator cannot be used for vertical applications.

CONTENTS

High Rigidity Slider Type Ball Screw Drive LEJS Series

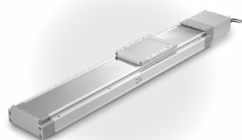
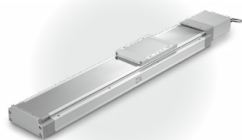

AC Servo Motor

LEJS/LECS□ Series

Model Selection	p. 289
How to Order	p. 305
Specifications	p. 306
Construction	p. 307
Dimensions	p. 308

LEJS-M (Built-in Intermediate Supports Type)/LECS□ Series

Model Selection	p. 289
How to Order	p. 310
Specifications	p. 311
Construction	p. 311
Dimensions	p. 312

LEJS/LECY□ Series

Model Selection	p. 303
How to Order	p. 318
Specifications	p. 319
Construction	p. 307
Dimensions	p. 320

LEJS-M (Built-in Intermediate Supports Type)/LECY□ Series

Model Selection	p. 303
How to Order	p. 322
Specifications	p. 319
Construction	p. 307
Dimensions	p. 320

LEJS100-X400

Model Selection	p. 300
How to Order	p. 313
Specifications	p. 314
Construction	p. 315
Dimensions	p. 316

Environment

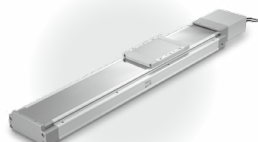

AC Servo Motor

Ball Screw Drive 11-LEJS Series

Clean Room Specification

Model Selection	p. 289, 303
Particle Generation Characteristics	p. 965
How to Order	p. 967, 969
Specifications	p. 968, 970
Dimensions	p. 971

Ball Screw Drive 25A-LEJS Series

Secondary Battery Compatible

Model Selection	p. 289, 303
How to Order	p. 981, 982

High Rigidity Slider Type Belt Drive LEJB Series

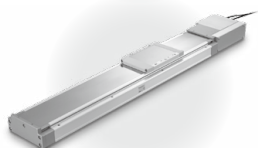
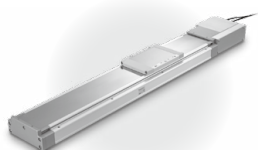

AC Servo Motor

LECS□ Series

Model Selection	p. 289
How to Order	p. 323
Specifications	p. 324
Construction	p. 325
Dimensions	p. 326

LECY□ Series

Model Selection	p. 303
How to Order	p. 328
Specifications	p. 329
Construction	p. 325
Dimensions	p. 330

Auto Switch Mounting	p. 332
Specific Product Precautions	p. 336

AC Servo Motor Drivers



LECSA Series	p. 1109
LECSB-T/LECS-C-T/LECSS-T Series	p. 1109
LECYM/LECYU Series	p. 1128

High Rigidity Slider Type

Ball Screw Drive *LEJS Series*

AC Servo Motor

LEJS Series p. 305, 318

LEJS-M Series p. 310, 322

LEJS-X400 p. 313

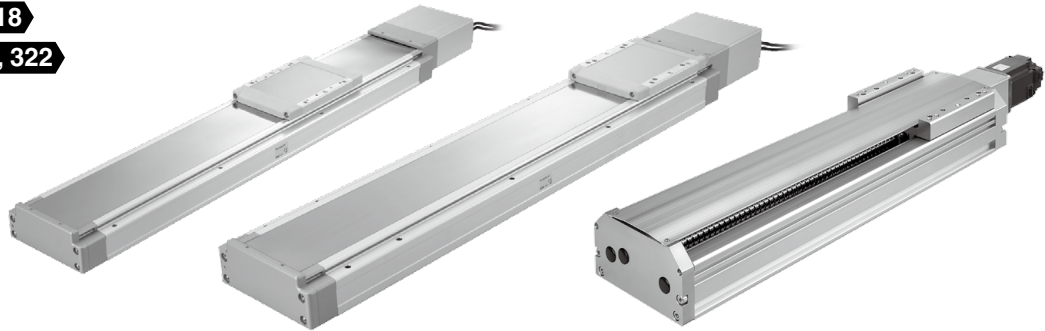

Clean Room Specification

11-LEJS Series

p. 967, 969

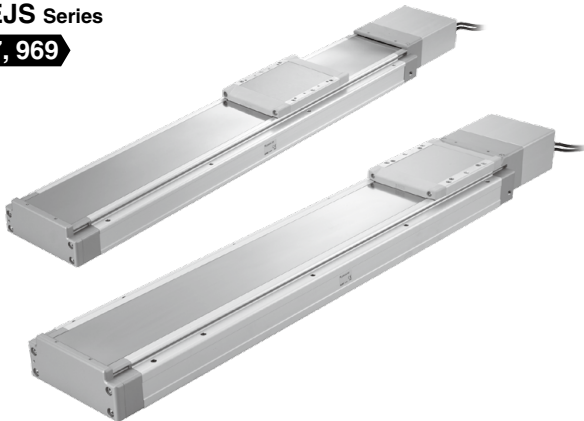

Secondary Battery Compatible

25A-LEJS Series

p. 981, 982



Belt Drive *LEJB Series*

AC Servo Motor

p. 323, 328



AC Servo Motor Drivers p. 1100

Model Selection



LEJS Series ▶ p. 305 **LEJS-M Series ▶ p. 310** **LEJB Series ▶ p. 323**
11-LEJS Series ▶ p. 967 **25A-LEJS Series ▶ p. 981**

Selection Procedure



Selection Example

Operating conditions

- Workpiece mass: 60 [kg]
 - Speed: 300 [mm/s]
 - Acceleration/Deceleration: 3000 [mm/s²]
 - Stroke: 300 [mm]
 - Mounting orientation: Horizontal
 - Motor type: Incremental encoder
 - External force: 10 [N]
- Workpiece mounting condition:
-

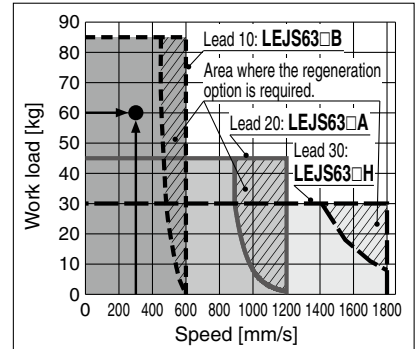

<Speed-Work load graph> (LEJS63)

Step 1 Check the work load-speed. <Speed-Work load graph> (Page 290)

Select a model based on the workpiece mass and speed while referencing the speed-work load graph. Selection example) The **LEJS63S3B-300** can be temporarily selected as a possible candidate based on the graph shown on the right side.

The regeneration option may be necessary. Refer to page 290 for the "Required Conditions for the Regeneration Option."

Step 2 Check the cycle time.

Refer to method 1 for a rough estimate, and method 2 for a more precise value.

Method 1: Check the cycle time graph (Pages 291, 292)

The graph is based on the maximum speed of each size.

Method 2: Calculation

Cycle time:

T can be found from the following equation.

$$T = T1 + T2 + T3 + T4 \text{ [s]}$$

- T1 and T3 can be found by the following equation.

$$T1 = V/a1 \text{ [s]} \quad T3 = V/a2 \text{ [s]}$$

The acceleration and deceleration values have upper limits depending on the workpiece mass and the duty ratio.

Check that they do not exceed the upper limit, by referring to "Work Load-Acceleration/Deceleration Graph (Guide)" (Pages 293 to 295).

For the ball screw type, there is an upper limit of the speed depending on the stroke. Check that it does not exceed the upper limit, by referring to the specifications (Page 306).

- T2 can be found from the following equation.

$$T2 = \frac{L - 0.5 \cdot V \cdot (T1 + T3)}{V} \text{ [s]}$$

- T4 varies depending on the motor type and load. The value below is recommended.

$$T4 = 0.05 \text{ [s]}$$

Calculation example)

T1 to T4 can be calculated as follows.

$$T1 = V/a1 = 300/3000 = 0.1 \text{ [s]}$$

$$T3 = V/a2 = 300/3000 = 0.1 \text{ [s]}$$

$$T2 = \frac{L - 0.5 \cdot V \cdot (T1 + T3)}{V} = \frac{300 - 0.5 \cdot 300 \cdot (0.1 + 0.1)}{300} = 0.90 \text{ [s]}$$

$$T4 = 0.05 \text{ [s]}$$

The cycle time can be found as follows.

$$T = T1 + T2 + T3 + T4 = 0.1 + 0.90 + 0.1 + 0.05 = 1.15 \text{ [s]}$$

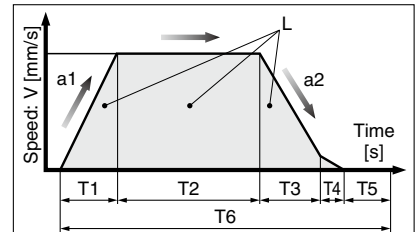

L : Stroke [mm]

V : Speed [mm/s]

a1 : Acceleration [mm/s²]

a2 : Deceleration [mm/s²]

T1 : Acceleration time [s]

Time until reaching the set speed

T2 : Constant speed time [s]

Time while the actuator is operating at a constant speed

T3 : Deceleration time [s]

Time from the beginning of the constant speed operation to stop

T4 : Settling time [s]

Time until positioning is completed

T5 : Resting time [s]

Time the product is not running

T6 : Total time [s]

Total time from T1 to T5

Duty ratio: Ratio of T to T6

$$T \div T6 \times 100$$

Step 3 Check the allowable moment. <Static allowable moment> (page 295)

<Dynamic allowable moment> (page 296)

Confirm the moment that applies to the actuator is within the allowable range for both static and dynamic conditions.



Selection example)
 Select the **LEJS63S3B-300** from the graph on the right side.
 Confirm that the external force is 20 [N] or less.
 (The external force is the resistance due to cable duct, flexible trunking or air tubing.)

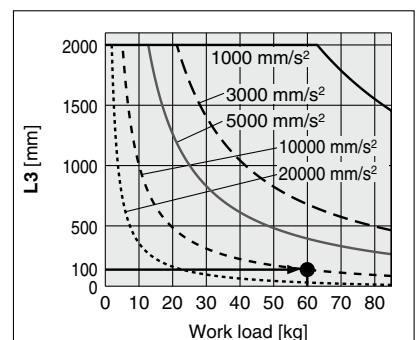

<Dynamic allowable moment> (LEJS63)

Speed-Work Load Graph/Required Conditions for the Regeneration Option (Guide)

LEJS40/Ball Screw Drive

Horizontal

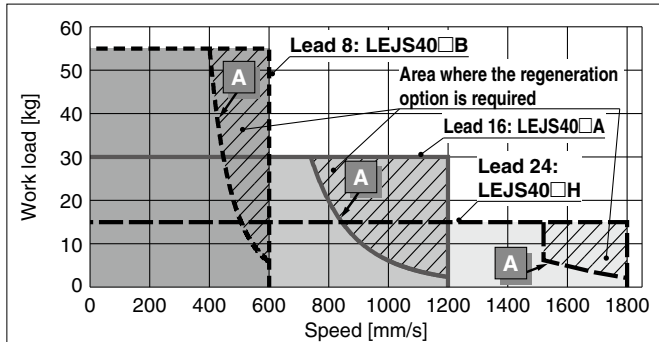

Vertical

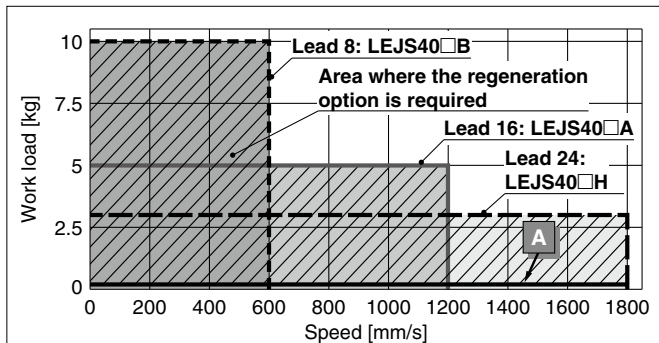

LEJB40/Belt Drive

Horizontal

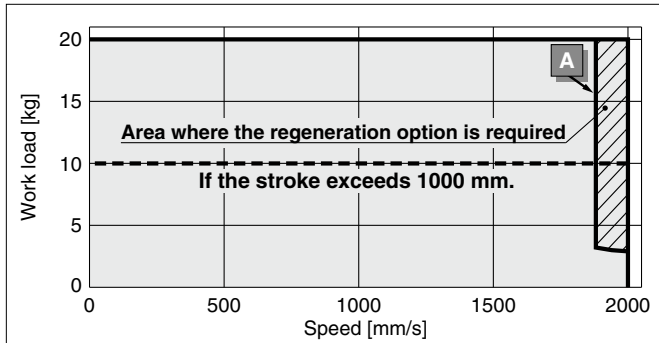

* When the stroke of the LEJB40 series exceeds 1000 mm, the work load is 10 kg.

Required conditions for the regeneration option

* The regeneration option is required when using the product above the regeneration line in the graph. (It must be ordered separately.)

LEJS63/Ball Screw Drive

Horizontal

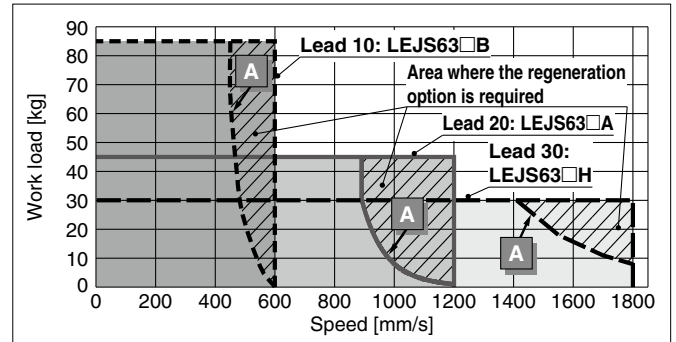

Vertical

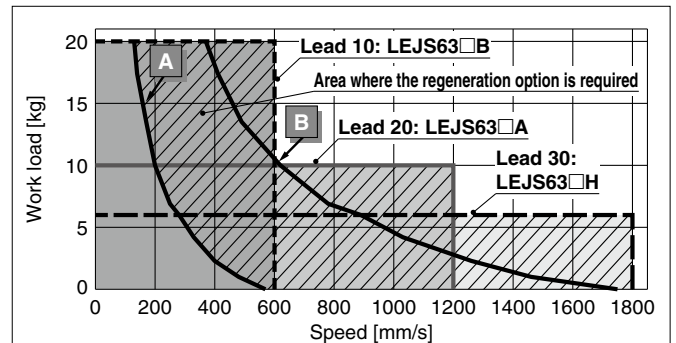

LEJB63/Belt Drive

Horizontal

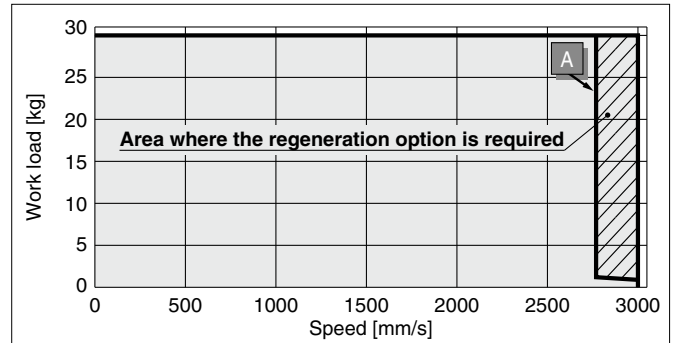

Regeneration Option Models

Operating condition	Regenerative condition	Regeneration option
A	Duty ratio	LEC-MR-RB-032
B	100%	LEC-MR-RB-12

Allowable Stroke Speed

Model	AC servo motor	Lead		Stroke [mm]														
		Symbol	[mm]	Up to 200	Up to 300	Up to 400	Up to 500	Up to 600	Up to 700	Up to 800	Up to 900	Up to 1000	Up to 1100	Up to 1200	Up to 1300	Up to 1400	Up to 1500	
LEJS40	100 W/ □40	H	24					1800										
		A	16					1200										
		B	8					600										
		(Motor rotation speed)						(4500 rpm)										
LEJS63	200 W/ □60	H	30															
		A	20															
		B	10															
		(Motor rotation speed)																

Cycle Time Graph (Guide)

LEJS40/Ball Screw Drive

LEJS40□H

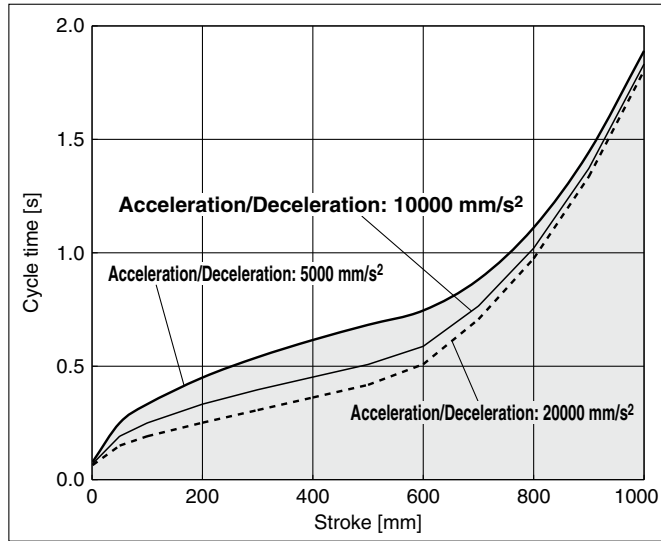

LEJS40□A

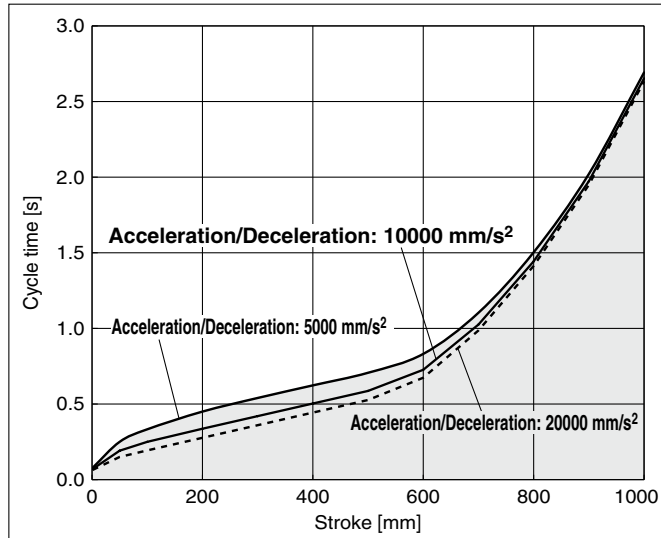

LEJS40□B

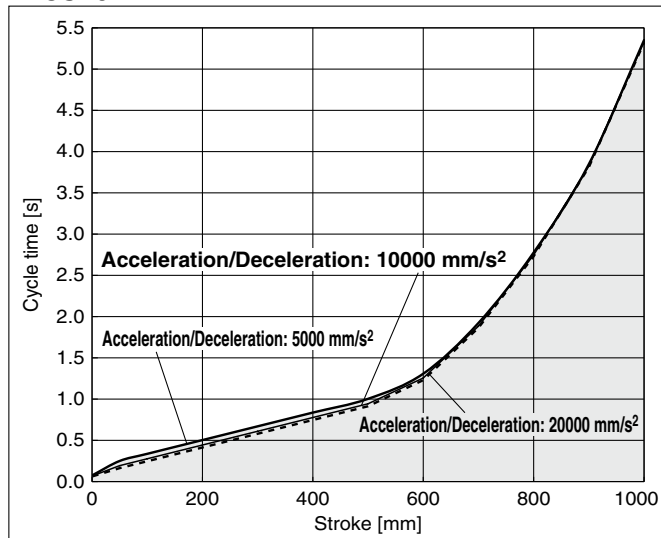

LEJS63/Ball Screw Drive

LEJS63□H

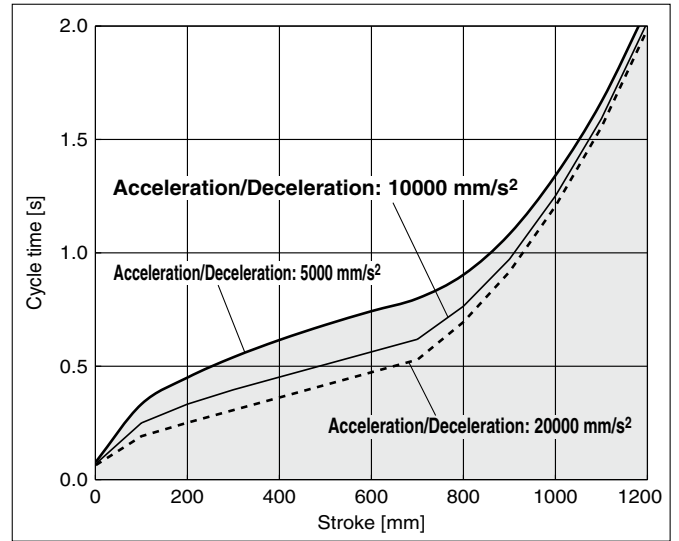

LEJS63□A

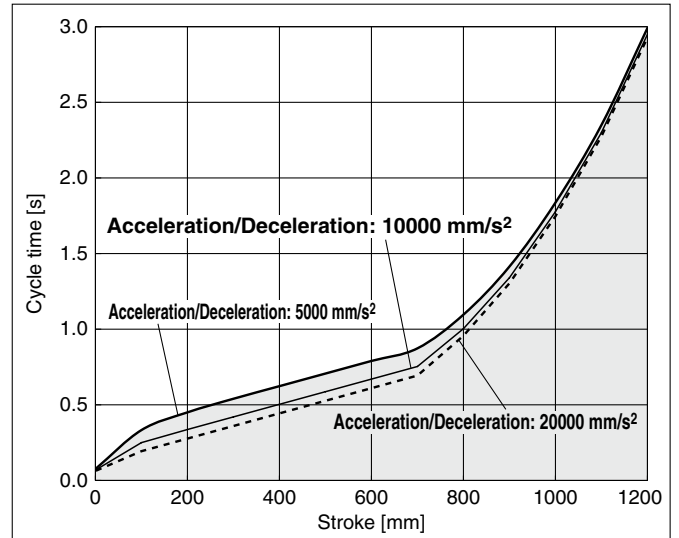

LEJS63□B

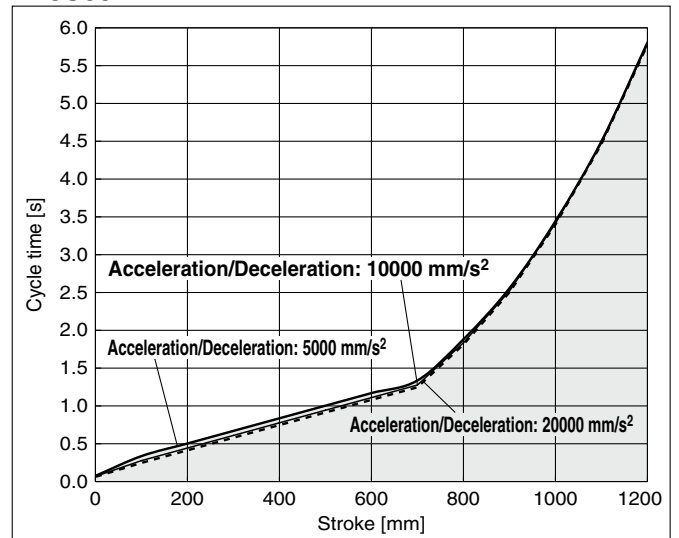

* Maximum speed/acceleration/deceleration values graph for each stroke

Cycle Time Graph (Guide)

LEJB40/Belt Drive

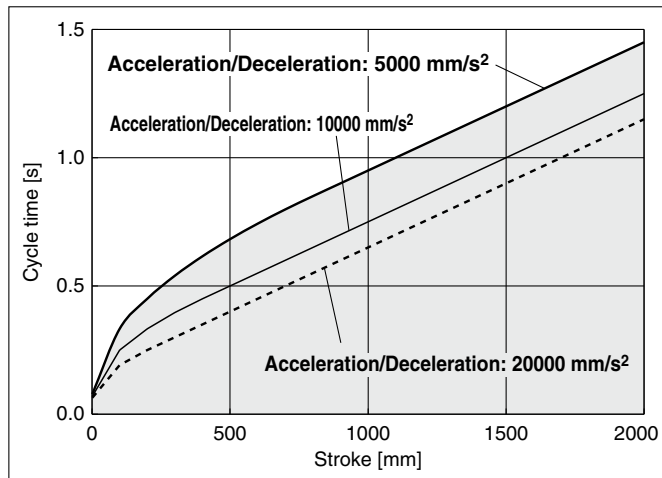

* Maximum speed/acceleration/deceleration values graph for each stroke

LEJB63/Belt Drive

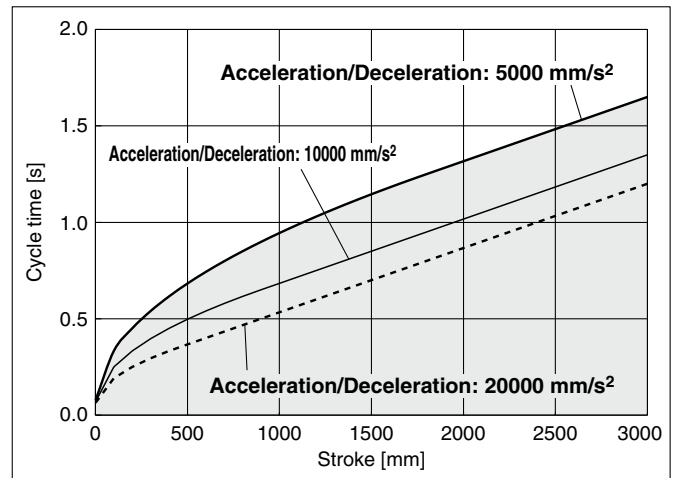

Work Load–Acceleration/Deceleration Graph (Guide)

LEJS40/Ball Screw Drive: Horizontal

LEJS40□H

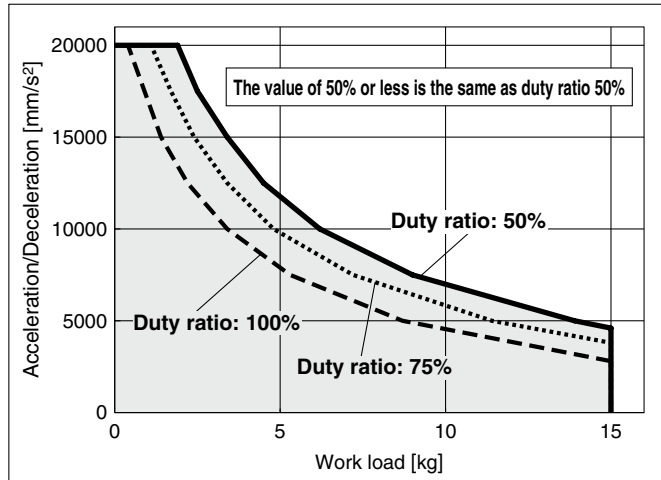

LEJS63/Ball Screw Drive: Horizontal

LEJS63□H

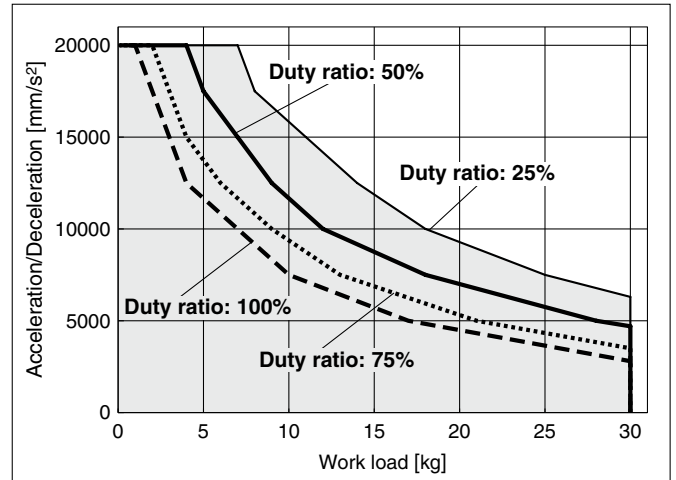

LEJS40□A

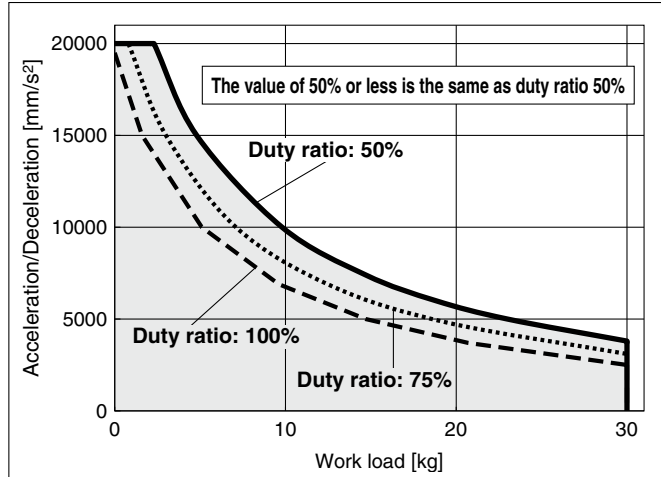

LEJS63□A

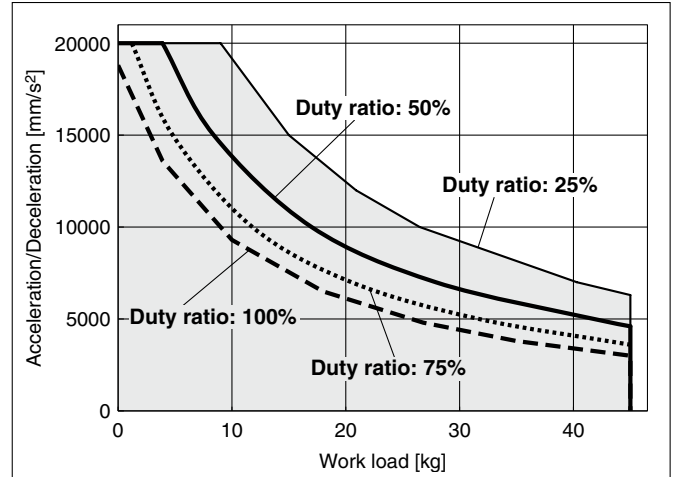

LEJS40□B

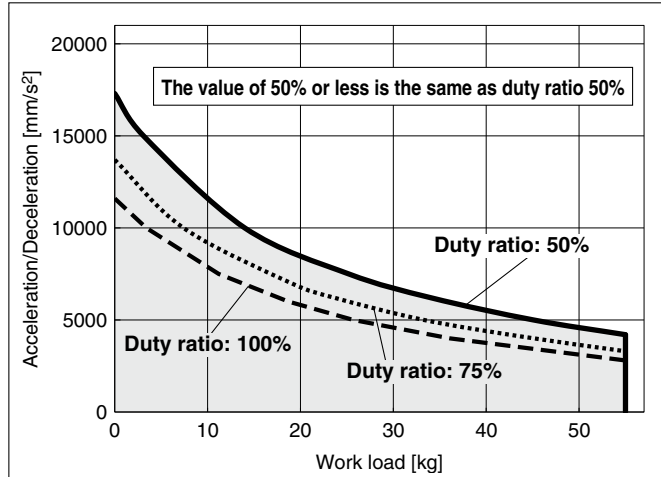

LEJS63□B

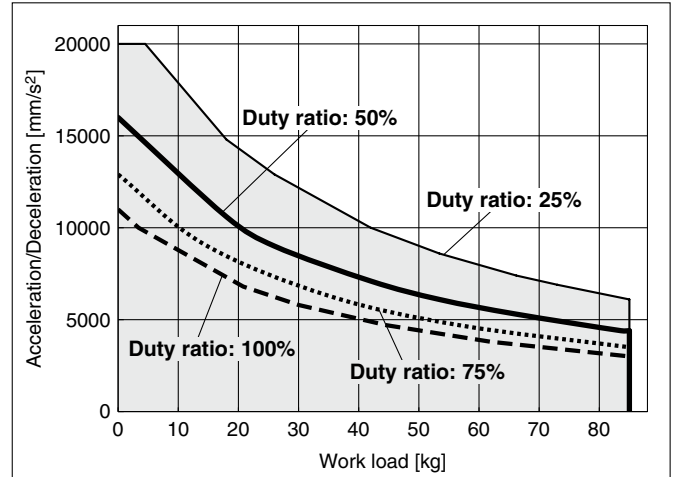

Work Load–Acceleration/Deceleration Graph (Guide)

LEJS40/Ball Screw Drive: Vertical

LEJS40□H

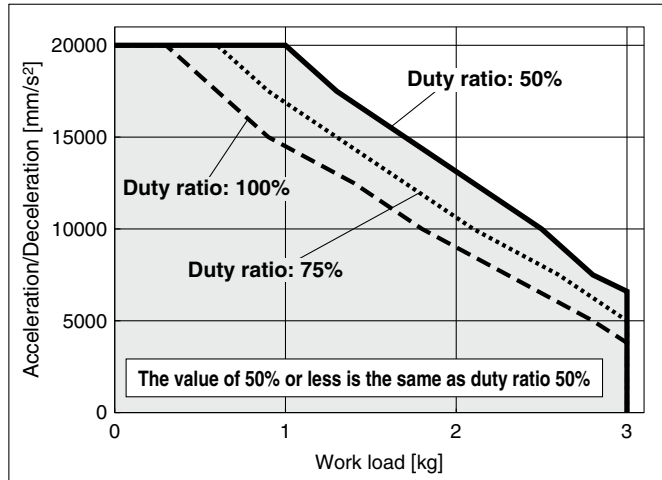

LEJS63/Ball Screw Drive: Vertical

LEJS63□H

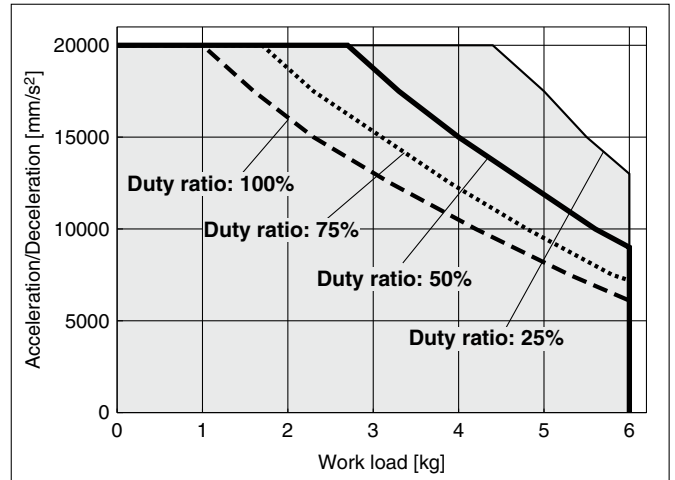

LEJS40□A

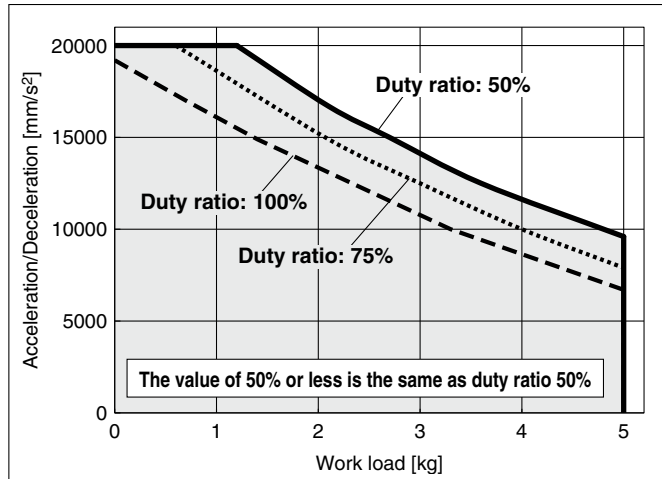

LEJS63□A

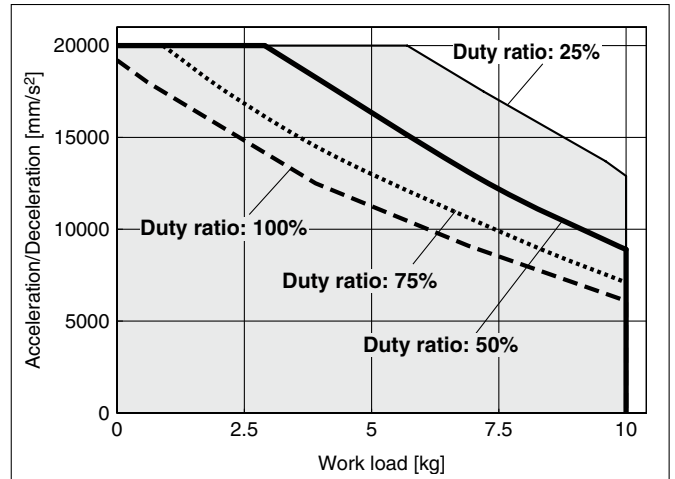

LEJS40□B

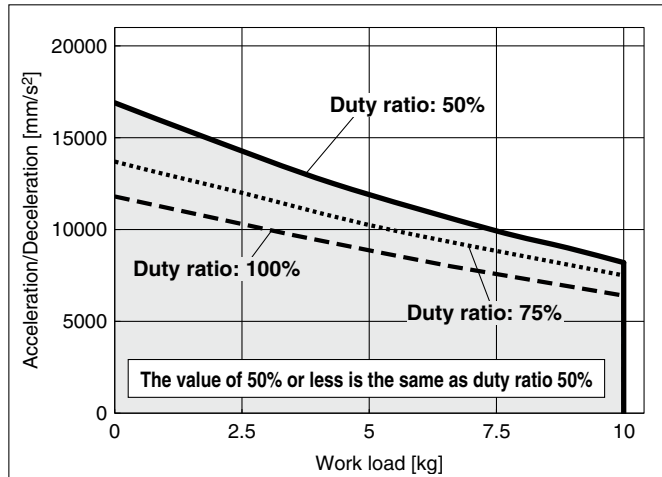

LEJS63□B

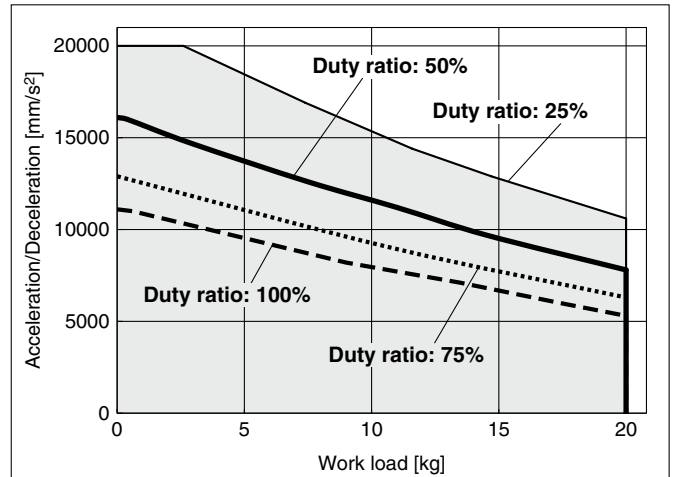

Work Load–Acceleration/Deceleration Graph (Guide)

LEJB40/Belt Drive: Horizontal

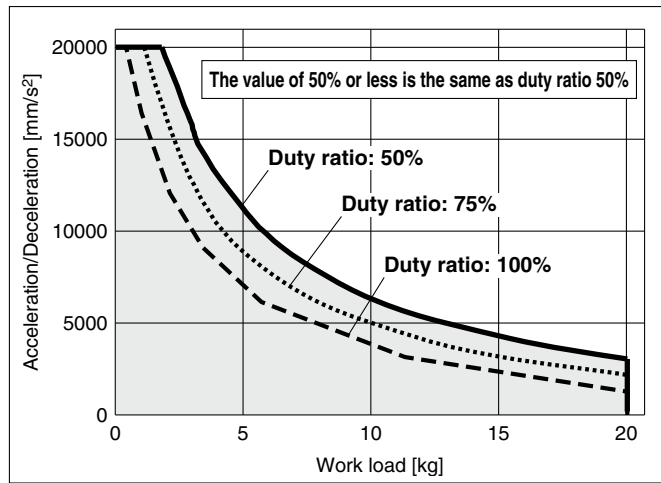

LEJB63/Belt Drive: Horizontal

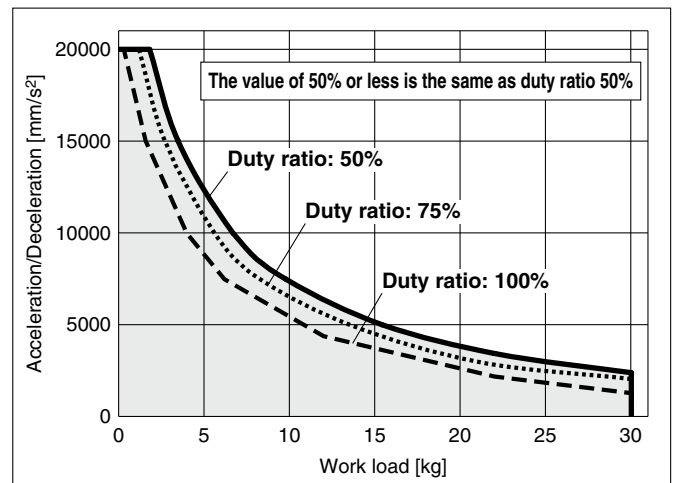

Static Allowable Moment*1

[N·m]

Model	Size	Pitching	Yawing	Rolling
LEJS	40	83.9	88.2	88.2
	63	121.5	135.1	135.1
LEJB	40	83.9	88.2	88.2
	63	121.5	135.1	135.1



*1 The static allowable moment is the amount of static moment which can be applied to the actuator when it is stopped.

If the product is exposed to impact or repeated load, be sure to take adequate safety measures when using the product.

Dynamic Allowable Moment

* These graphs show the amount of allowable overhang (guide unit) when the center of gravity of the workpiece overhangs in one direction. When selecting the overhang, refer to the "Calculation of Guide Load Factor" or the Electric Actuator Model Selection Software for confirmation: <https://www.smcworld.com>

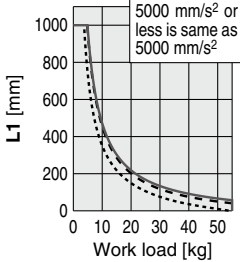
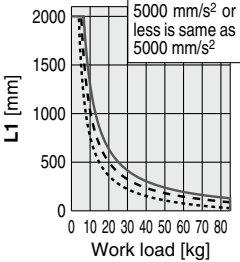
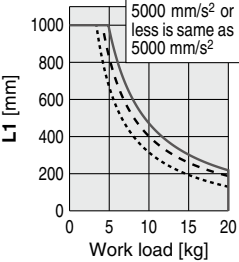
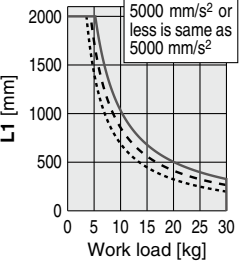
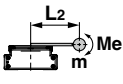
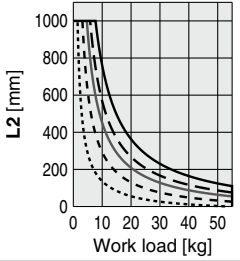
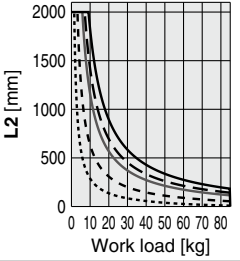
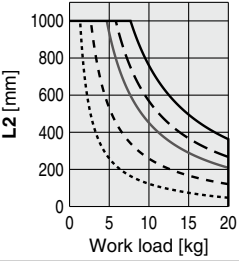
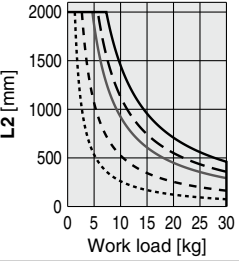
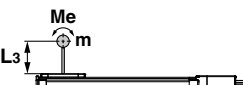
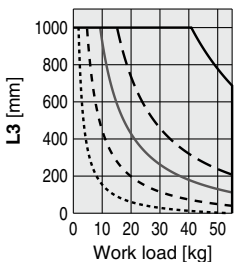
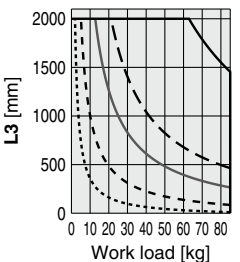
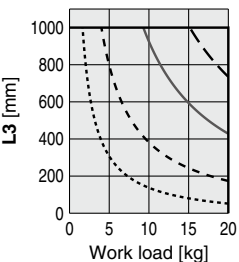
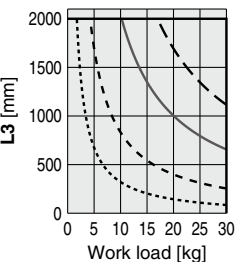
Acceleration/Deceleration ——— 1000 mm/s² - - - 3000 mm/s² ——— 5000 mm/s² - - - 10000 mm/s² ······ 20000 mm/s²

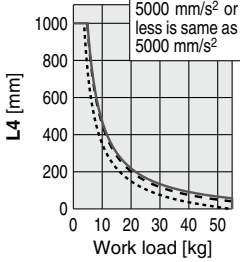
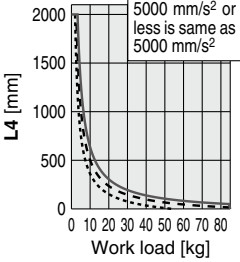
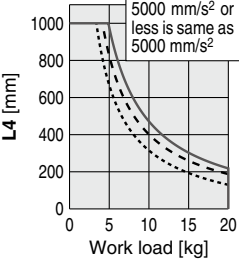
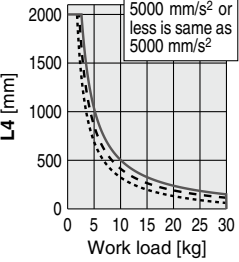
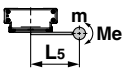
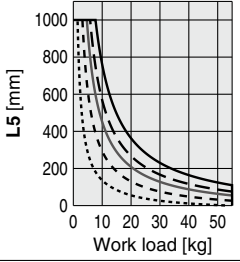
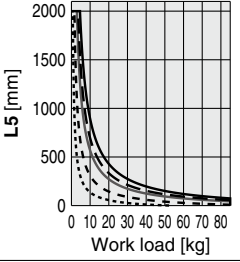
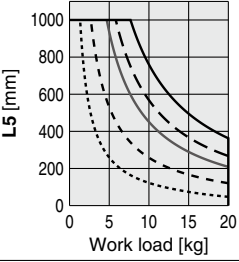
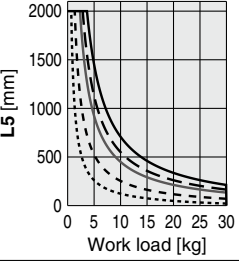
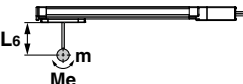
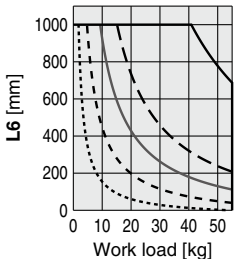
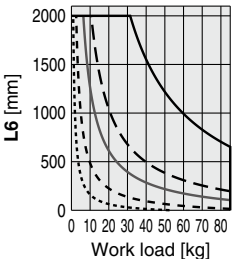
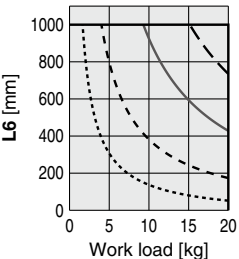
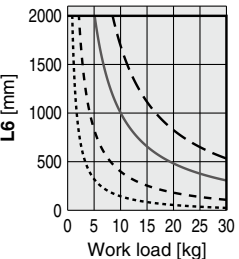
Orientation		Model			
Load overhanging direction m : Work load [kg] Me: Allowable moment [N·m] L : Overhang to the work load center of gravity [mm]		LEJS40	LEJS63	LEJB40	LEJB63
Horizontal	X 				
	Y 				
	Z 				
Bottom	X 				
	Y 				
	Z 				

* These graphs show the amount of allowable overhang (guide unit) when the center of gravity of the workpiece overhangs in one direction. When selecting the overhang, refer to the "Calculation of Guide Load Factor" or the Electric Actuator Model Selection Software for confirmation: <https://www.smcworld.com>

Dynamic Allowable Moment

Acceleration/Deceleration ——— 1000 mm/s² - - - 3000 mm/s² ——— 5000 mm/s² - - - - 10000 mm/s² ······ 20000 mm/s²

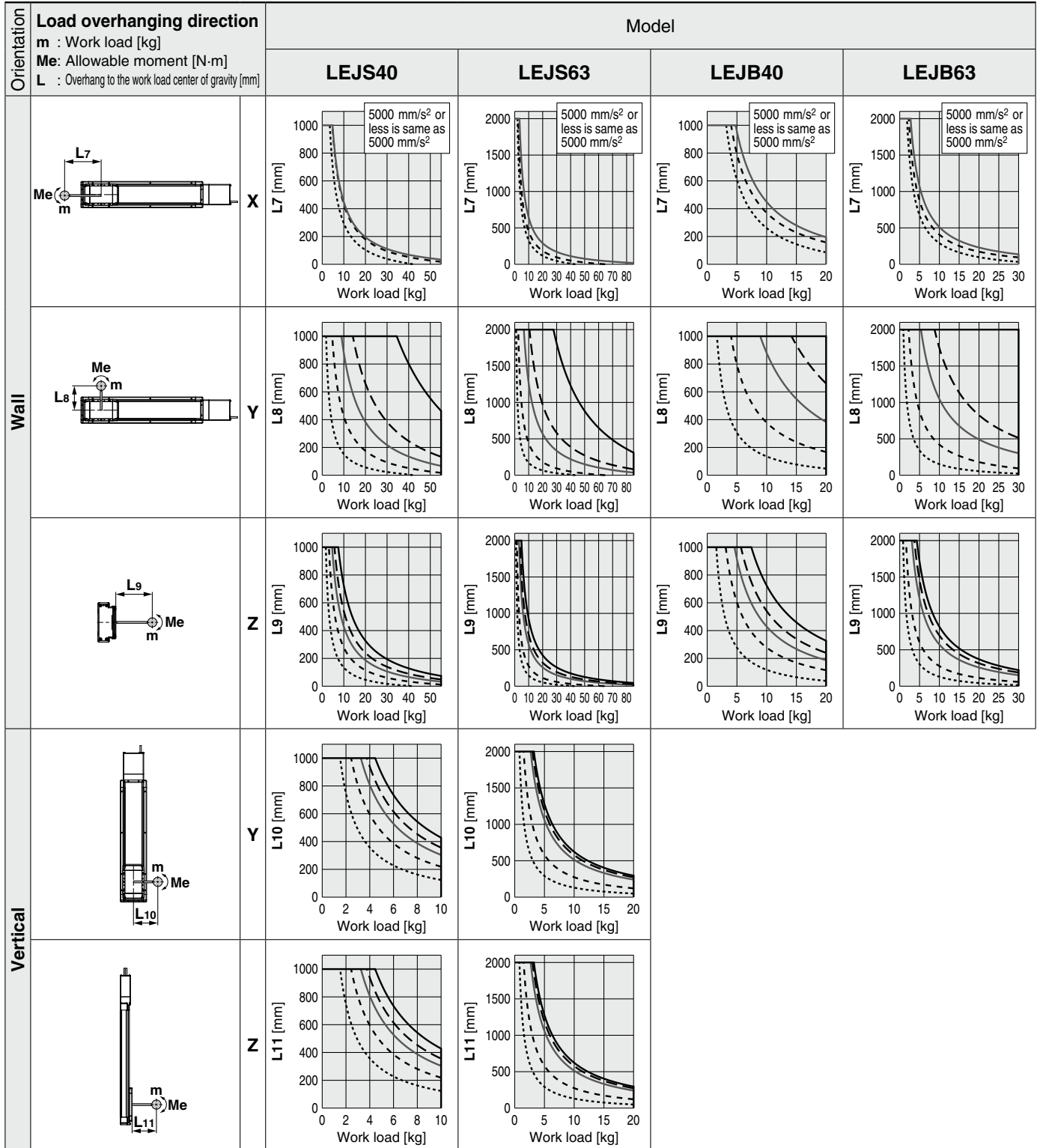

Calculation of Guide Load Factor

1. Decide operating conditions.

Model: LEJS/LEJB

Size: 40/63

Mounting orientation: Horizontal/Bottom/Wall/Vertical

Acceleration [mm/s^2]: **a**

Work load [kg]: **m**

Work load center position [mm]: **Xc/Yc/Zc**

2. Select the target graph while referencing the model, size, and mounting orientation.

3. Based on the acceleration and work load, find the overhang [mm]: **Lx/Ly/Lz** from the graph.

4. Calculate the load factor for each direction.

$$\alpha_x = X_c/L_x, \alpha_y = Y_c/L_y, \alpha_z = Z_c/L_z$$

5. Confirm the total of α_x , α_y , and α_z is 1 or less.

$$\alpha_x + \alpha_y + \alpha_z \leq 1$$

When 1 is exceeded, please consider a reduction of acceleration and work load, or a change of the work load center position and series.

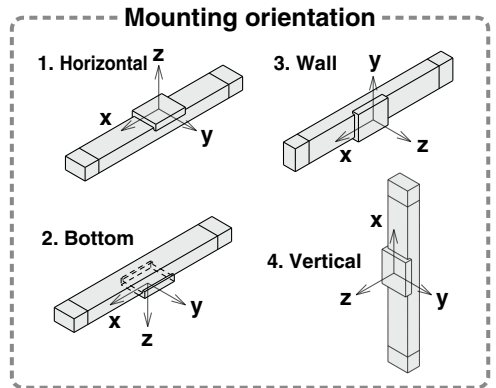

Example

1. Operating conditions

Model: LEJS

Size: 40

Mounting orientation: Horizontal

Acceleration [mm/s^2]: 5000

Work load [kg]: 20

Work load center position [mm]: **Xc = 0, Yc = 50, Zc = 200**

2. Select the graph on page 296, top and left side first row.

3. **Lx = 220 mm, Ly = 210 mm, Lz = 430 mm**

4. The load factor for each direction can be found as follows.

$$\alpha_x = 0/220 = 0$$

$$\alpha_y = 50/210 = 0.24$$

$$\alpha_z = 200/430 = 0.47$$

5. $\alpha_x + \alpha_y + \alpha_z = 0.71 \leq 1$

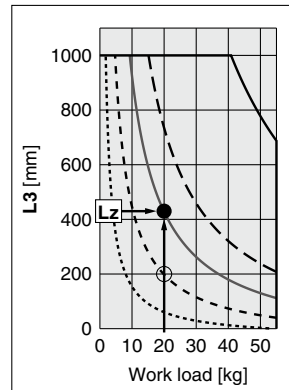
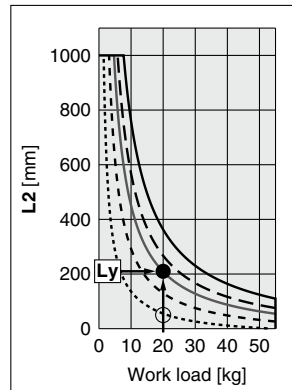
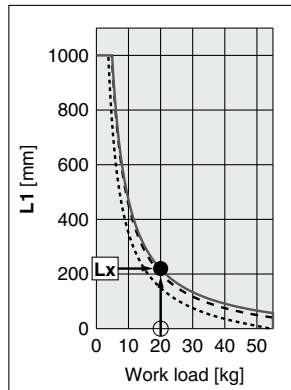

LEJ Series

AC Servo Motor

Clean Room Specification

Table Accuracy (Reference Value)

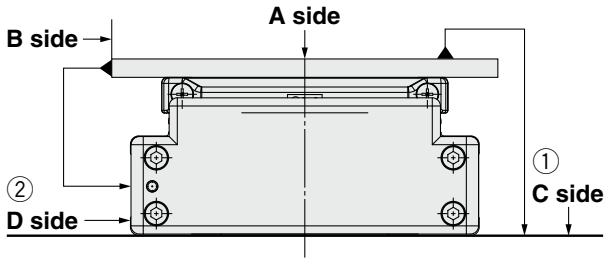

Model	Traveling parallelism [mm] (Every 300 mm)	
	① C side traveling parallelism to A side	② D side traveling parallelism to B side
LEJ□40	0.05	0.03
LEJ□63	0.05	0.03
LEJ□100	0.05	0.04

* Traveling parallelism does not include the mounting surface accuracy.

Table Displacement (Reference Value)

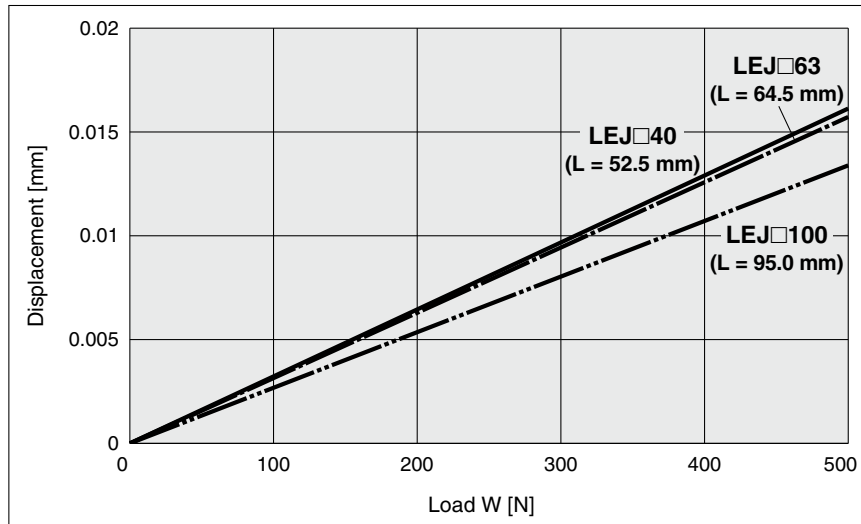
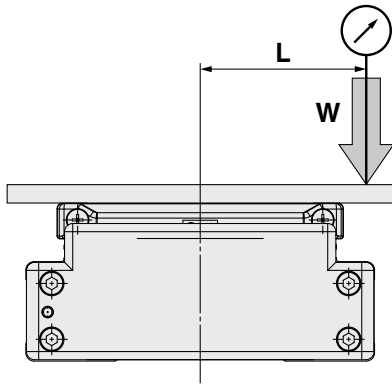

* This displacement is measured when a 15 mm aluminum plate is mounted and fixed on the table. (Table clearance is included.)



Model Selection

LEJS Series ▶ p. 318 **LEJS-M Series** ▶ p. 322 **LEJB Series** ▶ p. 328 **11-LEJS Series** ▶ p. 969 **25A-LEJS Series** ▶ p. 982

Speed–Work Load Graph/Required Conditions for the Regeneration Option (Guide)

Horizontal

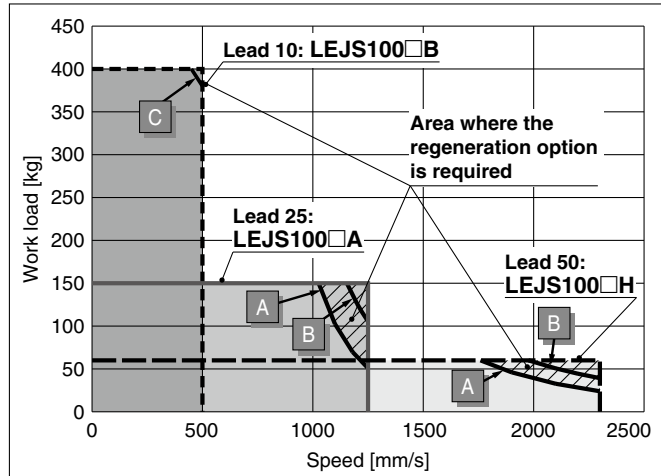

Vertical

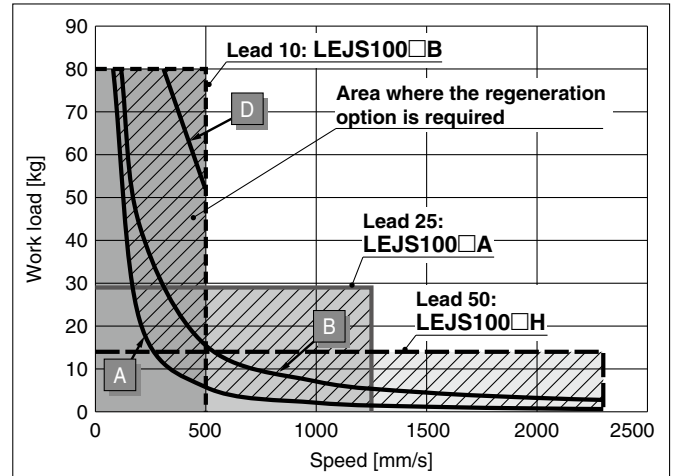

Required conditions for the regeneration option

* The regeneration option is required if the product is to be used in the "area beyond the regeneration line (A, B, C, or D)" in the graph. (Order separately.)

Regeneration Option Models

Operating condition	Regenerative condition Duty ratio	Regeneration option
A	100%	LEC-MR-RB-032
B		
C	80%	LEC-MR-RB-12
D	65%	

* Confirm the operating area, and order the regeneration option if needed.

Static Allowable Moment*1

[N·m]

Model	Size	Pitching	Yawing	Rolling
LEJS	100	805	771	939

*1 The static allowable moment is the amount of static moment which can be applied to the actuator when it is stopped.

If the product is exposed to impact or repeated load, be sure to take adequate safety measures when using the product.

LEJS100-X400

AC Servo Motor

* These graphs show the amount of allowable overhang (guide unit) when the center of gravity of the workpiece overhangs in one direction. When selecting the overhang, refer to "Calculation of Guide Load Factor" for confirmation.

Dynamic Allowable Moment

Acceleration/Deceleration ——— 1000 mm/s² - - - - 3000 mm/s² ——— 5000 mm/s² ······ 9800 mm/s²

Orientation		Load overhanging direction	
Orientation		Load overhanging direction	
m: Work load [kg]		m: Work load [kg]	
Me: Dynamic allowable moment [N·m]		Me: Dynamic allowable moment [N·m]	
L: Overhang to the work load center of gravity [mm]		L: Overhang to the work load center of gravity [mm]	
Horizontal	X		
	Y		
	Z		
Bottom	X		
	Y		
	Z		
Wall	X		
	Y		
	Z		
Vertical	Y		
	Z		

Calculation of Guide Load Factor

1. Decide operating conditions.

Model: LEJS-X400

Size: 100

Mounting orientation: Horizontal/Bottom/Wall/Vertical

Acceleration [mm/s²]: **a**

Work load [kg]: **m**

Work load center position [mm]: **Xc/Yc/Zc**

2. Select the target graph with reference to the model, size, and mounting orientation.

3. Based on the acceleration and work load, obtain the overhang [mm]: **Lx/Ly/Lz** from the graph.

4. Calculate the load factor for each direction.

$$\alpha_x = Xc/Lx \quad \alpha_y = Yc/Ly \quad \alpha_z = Zc/Lz$$

5. Confirm the total of α_x , α_y , and α_z is 1 or less.

$$\alpha_x + \alpha_y + \alpha_z \leq 1$$

When 1 is exceeded, please consider a reduction of acceleration and work load, or a change of the work load center position and series.

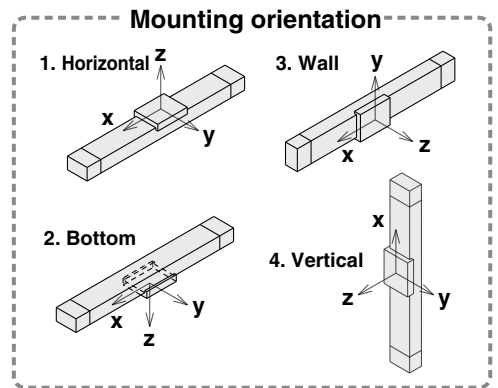

Example

1. Operating conditions

Model: LEJS-X400

Size: 100

Mounting orientation: Horizontal

Acceleration [mm/s²]: 5000

Work load [kg]: 100

Work load center position [mm]: **Xc = 50, Yc = 100, Zc = 200**

2. Select the graph on page 301, top and left side first row.

3. **Lx = 300 mm, Ly = 380 mm, Lz = 650 mm**

4. The load factor for each direction can be obtained as follows.

$$\alpha_x = 50/300 = 0.17$$

$$\alpha_y = 100/380 = 0.26$$

$$\alpha_z = 200/650 = 0.31$$

5. $\alpha_x + \alpha_y + \alpha_z = 0.74 \leq 1$

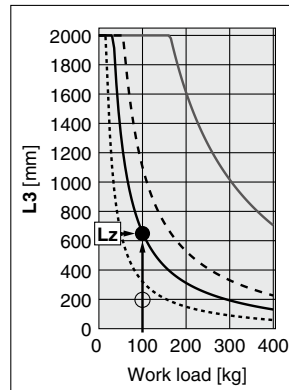
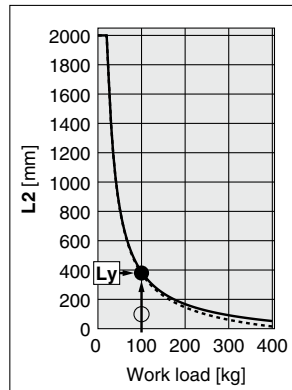
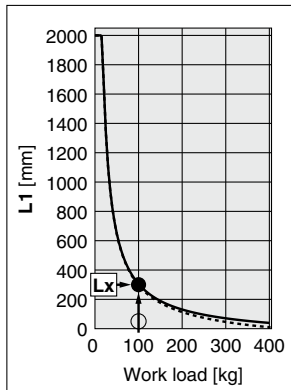

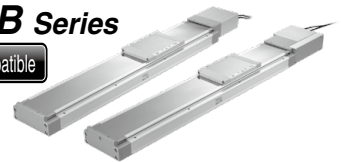

Model Selection

LEJS Series ▶ p. 318 **LEJS-M Series ▶ p. 322** **LEJB Series ▶ p. 328** **11-LEJS Series ▶ p. 969** **25A-LEJS Series ▶ p. 982**

Selection Procedure

The Cycle Time Graph, Work Load–Acceleration/Deceleration Graph, Dynamic Allowable Moment, Calculation of Guide Load Factor, and Table Accuracy/Displacement are the same as those of the LECS AC servo motor. For details, refer to page 291 and onward.



Selection Example

Operating conditions

- Workpiece mass: 60 [kg]
 - Speed: 300 [mm/s]
 - Acceleration/Deceleration: 3000 [mm/s²]
 - Stroke: 300 [mm]
 - Mounting orientation: Horizontal
 - External force: 10 [N]
- Workpiece mounting condition:

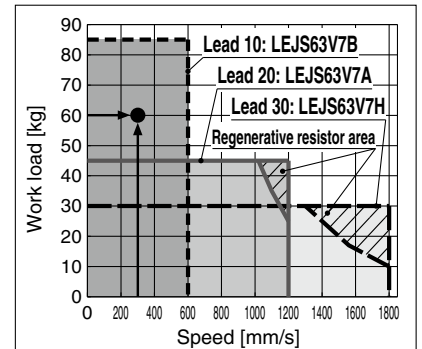
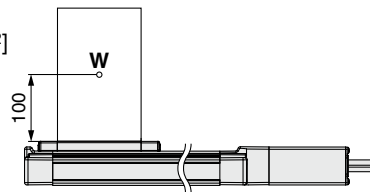

<Speed-Work load graph> (LEJS63)

Step 1 Check the work load-speed. <Speed-Work load graph> (Page 304)

Select a model based on the workpiece mass and speed while referencing the speed-work load graph. Selection example) The **LEJS63V7B-300** can be temporarily selected as a possible candidate based on the graph shown on the right side.

The regenerative resistor may be necessary.
 Refer to page 304 for the “Required Conditions for the Regenerative Resistor (Guide).”

Step 2 Check the cycle time.

Refer to method 1 for a rough estimate, and method 2 for a more precise value.

Method 1: Check the cycle time graph (Pages 291, 292)

The graph is based on the maximum speed of each size.

Method 2: Calculation

Cycle time:

T can be found from the following equation.

$$T = T1 + T2 + T3 + T4 \text{ [s]}$$

- T1 and T3 can be found by the following equation.

$$T1 = V/a1 \text{ [s]} \quad T3 = V/a2 \text{ [s]}$$

The acceleration and deceleration values have upper limits depending on the workpiece mass and the duty ratio. Check that they do not exceed the upper limit, by referring to “Work Load–Acceleration/Deceleration Graph (Guide)” (Pages 293 to 295).

For the ball screw type, there is an upper limit of the speed depending on the stroke. Check that it does not exceed the upper limit, by referring to the specifications (Page 319).

- T2 can be found from the following equation.

$$T2 = \frac{L - 0.5 \cdot V \cdot (T1 + T3)}{V} \text{ [s]}$$

- T4 varies depending on the motor type and load. The value below is recommended.

$$T4 = 0.05 \text{ [s]}$$

Calculation example)

T1 to T4 can be calculated as follows.

$$T1 = V/a1 = 300/3000 = 0.1 \text{ [s]}$$

$$T3 = V/a2 = 300/3000 = 0.1 \text{ [s]}$$

$$T2 = \frac{L - 0.5 \cdot V \cdot (T1 + T3)}{V} = \frac{300 - 0.5 \cdot 300 \cdot (0.1 + 0.1)}{300} = 0.90 \text{ [s]}$$

$$T4 = 0.05 \text{ [s]}$$

The cycle time can be found as follows.

$$T = T1 + T2 + T3 + T4 = 0.1 + 0.90 + 0.1 + 0.05 = 1.15 \text{ [s]}$$

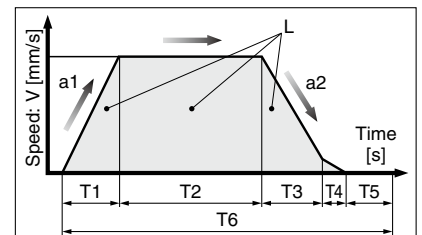

L : Stroke [mm]

V : Speed [mm/s]

a1 : Acceleration [mm/s²]

a2 : Deceleration [mm/s²]

T1 : Acceleration time [s]

Time until reaching the set speed

T2 : Constant speed time [s]

Time while the actuator is operating at a constant speed

T3 : Deceleration time [s]

Time from the beginning of the constant speed operation to stop

T4 : Settling time [s]

Time until positioning is completed

T5 : Resting time [s]

Time the product is not running

T6 : Total time [s]

Total time from T1 to T5

Duty ratio: Ratio of T to T6

$$T \div T6 \times 100$$

Step 3 Check the allowable moment. <Static allowable moment> (page 295)

<Dynamic allowable moment> (page 296)

Confirm the moment that applies to the actuator is within the allowable range for both static and dynamic conditions.



Selection example)
 Select the **LEJS63V7B-300** from the graph on the right side. Confirm that the external force is 20 [N] or less. (The external force is the resistance due to cable duct, flexible trunking or air tubing.)

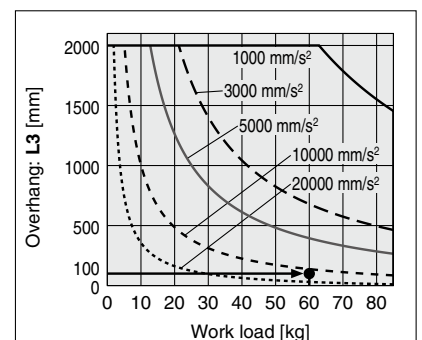

<Dynamic allowable moment> (LEJS63)

Speed-Work Load Graph/Required Conditions for the Regenerative Resistor (Guide)

LEJS40V6□/Ball Screw Drive

Horizontal

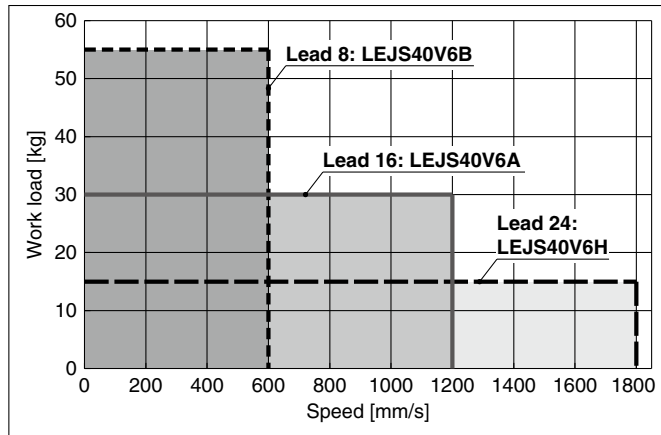

Vertical

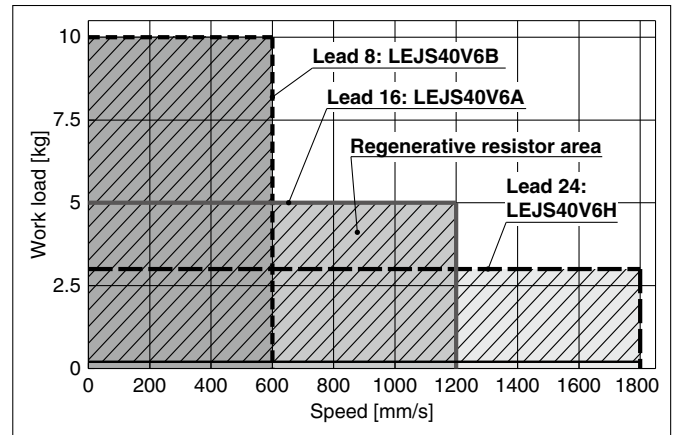

LEJS63V7□/Ball Screw Drive

Horizontal

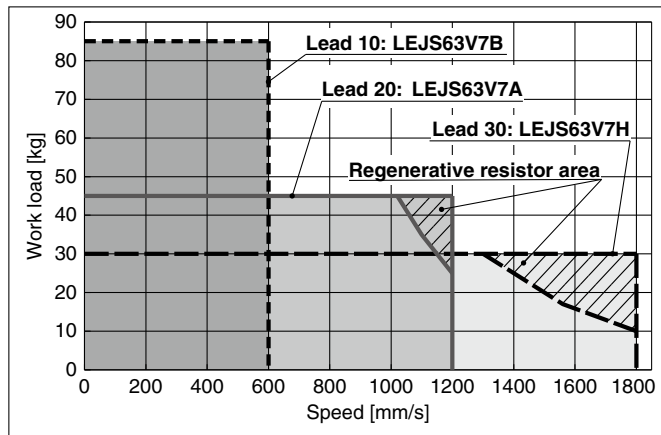

Vertical

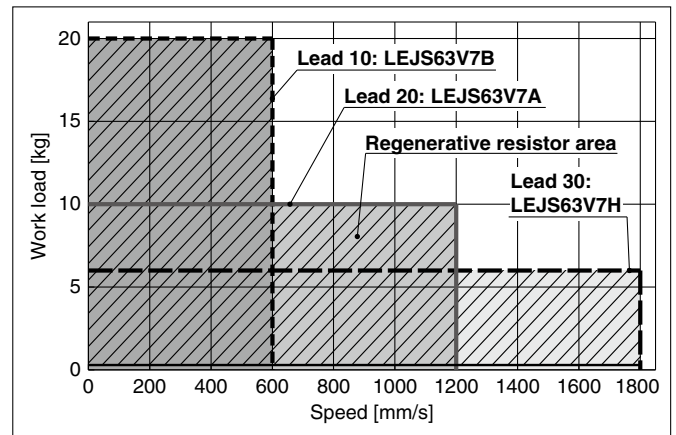

LEJB40V6T/Belt Drive

Horizontal

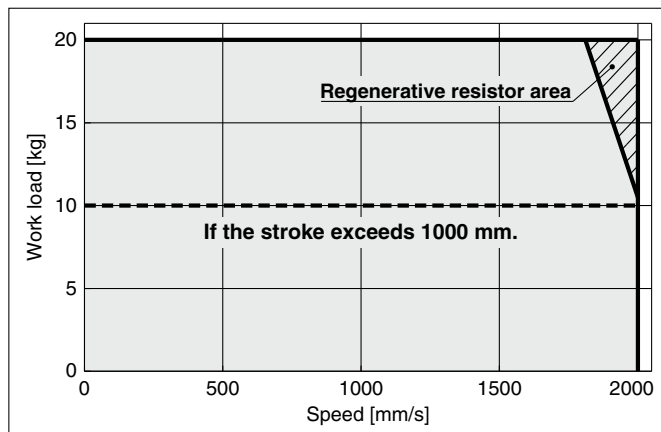

* When the stroke of the LEJB40 series exceeds 1000 mm, the work load is 10 kg.

Regenerative resistor area

* When using the actuator in the regenerative resistor area, download the "AC servo capacity selection program/SigmaJunmaSize+" from the SMC website. Then, calculate the necessary regenerative resistor capacity to prepare an appropriate external regenerative resistor.

* The regenerative resistor should be provided by the customer.

LEJB63V7T/Belt Drive

Horizontal

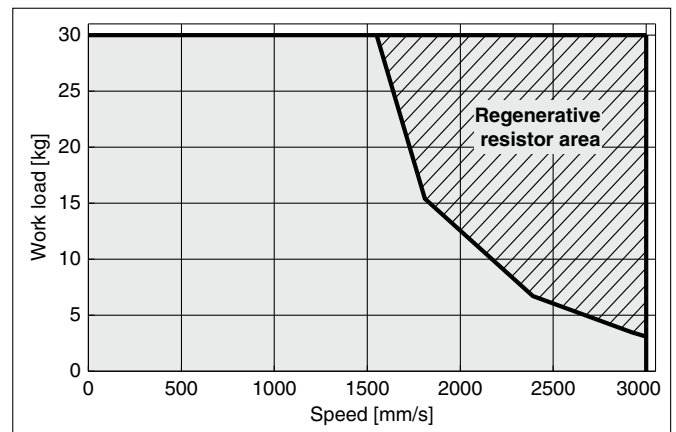

Applicable Motors/Drivers

Model	Applicable model	
	Motor	Servopack (SMC driver)
LEJ□40□	SGMJV-01A3A	SGDV-R90A11□ (LECYM2-V5)
		SGDV-R90A21□ (LECYU2-V5)
LEJ□63□	SGMJV-02A3A	SGDV-1R6A11□ (LECYM2-V7)
		SGDV-1R6A21□ (LECYU2-V7)

High Rigidity Slider Type Ball Screw Drive

LEJS Series



* For details, refer to page 1343 and onward.

Built-in Intermediate Supports Type▶p. 310 **LECY**□ Series▶p. 318

Clean Room Specification▶p. 967 **Secondary Battery Compatible**▶p. 981 **Motorless Type**▶p. 1213

How to Order

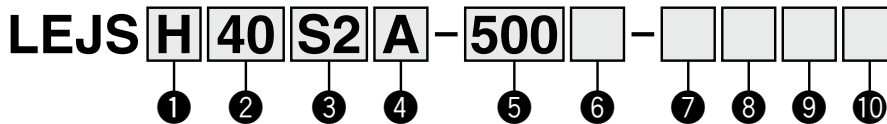

① Accuracy

Nil	Basic type
H	High-precision type

② Size

40
63

③ Motor type

Symbol	Type	Output [W]	② Size	⑨ Driver type	Compatible drivers
*1 S2	AC servo motor (Incremental encoder)	100	40	A1/A2	LECSA□-S1
S3		200	63	A1/A2	LECSA□-S3
*2 T6	AC servo motor (Absolute encoder)	100	40	B2	LECSB2-T5
T7				C2	LECSC2-T5
		200	63	B2	LECSB2-T7
C2				LECSC2-T7	
				S2	LECSS2-T7

*1 For motor type S2, the compatible driver part number suffix is S1.
*2 For motor type T6, the compatible driver part number is LECS□2-T5.

④ Lead [mm]

Symbol	LEJS40	LEJS63
H	24	30
A	16	20
B	8	10

⑤ Stroke [mm]*3

200 to 1500	*3 Refer to the applicable stroke table for details.
-------------	--

⑥ Motor option

Nil	Without option
B	With lock

⑦ Cable type*5 *6 *7

Nil	Without cable
S	Standard cable
R	Robotic cable

*6 A motor cable and encoder cable are included with the product. (A lock cable is also included if motor option "B: With lock" is selected.)
*7 Standard cable entry direction is "(A) Axis side." (Refer to page 1123 for details.)

⑧ Cable length [m]*5 *8

Nil	Without cable
2	2
5	5
A	10

*8 The length of the motor, encoder, and lock cables are the same.

⑨ Driver type*5

	Compatible drivers	Power supply voltage [V]
Nil	Without driver	—
A1	LECSA1-S□	100 to 120
A2	LECSA2-S□	200 to 230
B2	LECSB2-T□	200 to 240
C2	LECSC2-T□	200 to 230
S2	LECSS2-T□	200 to 240

*5 When a driver type is selected, a cable is included. Select the cable type and cable length.
Example
S2S2: Standard cable (2 m) + Driver (LECSS2)
S2: Standard cable (2 m)
Nil: Without cable and driver

⑩ I/O cable length*9

Nil	Without cable
H	Without cable (Connector only)
1	1.5 [m]

*9 When "Nil: Without driver" is selected for the driver type, only "Nil: Without cable" can be selected. Refer to page 1124 if an I/O cable is required. (Options are shown on page 1124.)

Applicable Stroke Table*4

Model	Stroke [mm]	200	300	400	500	600	700	800	900	1000	1200	1500
LEJS40		●	●	●	●	●	●	●	●	●	●	—
LEJS63		—	●	●	●	●	●	●	●	●	●	●

*4 Please contact SMC for non-standard strokes as they are produced as special orders.

Compatible Drivers

For auto switches, refer to pages 332 to 335.

Driver type	Pulse input type/ Positioning type	Pulse input type	CC-Link direct input type	SSCNET III/H type
Series	LECSA	LECSB-T	LECSC-T	LECSS-T
Number of point tables	Up to 7	Up to 255	Up to 255 (2 stations occupied)	—
Pulse input	○	○	—	—
Applicable network	—	—	CC-Link	SSCNET III/H
Control encoder	Incremental 17-bit encoder	Absolute 22-bit encoder	Absolute 18-bit encoder	Absolute 22-bit encoder
Communication function	USB communication	USB communication, RS422 communication	USB communication, RS422 communication	USB communication
Power supply voltage [V]	100 to 120 VAC (50/60 Hz) 200 to 230 VAC (50/60 Hz)	200 to 240 VAC (50/60 Hz)	200 to 230 VAC (50/60 Hz)	200 to 240 VAC (50/60 Hz)
Reference page	1109			

Specifications

AC Servo Motor (100/200 W)

Model		LEJS40S2/T6			LEJS63S3/T7				
Actuator specifications	Stroke [mm]*1	200, 300, 400, 500, 600, 700, 800 900, 1000, 1200			300, 400, 500, 600, 700, 800, 900 1000, 1200, 1500				
	Work load [kg]*2	Horizontal	15	30	55	30	45	85	
		Vertical	3	5	10	6	10	20	
	Speed*3 [mm/s]	Stroke range	Up to 500	1800	1200	600	1800	1200	600
			501 to 600	1580	1050	520	1800	1200	600
			601 to 700	1170	780	390	1800	1200	600
			701 to 800	910	600	300	1390	930	460
			801 to 900	720	480	240	1110	740	370
			901 to 1000	580	390	190	900	600	300
			1001 to 1100	480	320	160	750	500	250
			1101 to 1200	410	270	130	630	420	210
			1201 to 1300	—	—	—	540	360	180
	1301 to 1400	—	—	—	470	310	150		
	1401 to 1500	—	—	—	410	270	130		
	Max. acceleration/deceleration [mm/s ²]		20000 (Refer to pages 293 and 294 for limit according to work load and duty ratio.)						
Positioning repeatability [mm]	Basic type	±0.02							
	High-precision type	±0.01							
Lost motion [mm]*4	Basic type	0.1 or less							
	High-precision type	0.05 or less							
Lead [mm]		24	16	8	30	20	10		
Impact/Vibration resistance [m/s ²]*5		50/20							
Actuation type		Ball screw							
Guide type		Linear guide							
Static allowable moment*6 [N·m]	Mep (Pitching)	83.9			121.5				
	Mey (Yawing)	88.2			135.1				
	Mer (Rolling)	88.2			135.1				
Operating temperature range [°C]		5 to 40							
Operating humidity range [%RH]		90 or less (No condensation)							
Enclosure		IP30							
Regeneration option		May be required depending on speed and work load. (Refer to page 290.)							
Motor output [W]/Size [mm]		100□40			200□60				
Motor type		AC servo motor (100/200 VAC)							
Encoder*7		Motor type S2, S3: Incremental 17-bit encoder (Resolution: 131072 p/rev) Motor type T6, T7: Absolute 22-bit encoder (Resolution: 4194304 p/rev) (For LECSB-T□, LECSS-T□) Motor type T6, T7: Absolute 18-bit encoder (Resolution: 262144 p/rev) (For LECSB-T□)							
Power [W]*8		Max. power 445			Max. power 725				
Type*9		Non-magnetizing lock							
Holding force [N]		67	101	203	220	330	660		
Power consumption at 20°C [W]		6.3			7.9				
Rated voltage [V]		24 VDC ⁰ _{-10%}							

*1 Please contact SMC for non-standard strokes as they are produced as special orders.

*2 For details, refer to the "Speed-Work Load Graph (Guide)" on page 290.

*3 The allowable speed changes according to the stroke.

*4 A reference value for correcting errors in reciprocal operation

*5 Impact resistance: No malfunction occurred when the actuator was tested with a drop tester in both an axial direction and a perpendicular direction to the lead screw. (The test was performed with the actuator in the initial state.)

Vibration resistance: No malfunction occurred in a test ranging between 45 to 2000 Hz. The test was performed in both an axial direction and a perpendicular direction to the lead screw. (The test was performed with the actuator in the initial state.)

*6 The static allowable moment is the amount of static moment which can be applied to the actuator when it is stopped.

If the product is exposed to impact or repeated load, be sure to take adequate safety measures when using the product.

*7 The resolution will change depending on the driver type.

*8 Indicates the max. power during operation (including the driver)

When selecting the power supply capacity, refer to the power supply capacity in the operation manual of each driver.

*9 Only when motor option "With lock" is selected

* Sensor magnet position is located in the table center. For detailed dimensions, refer to the "Auto Switch Mounting Position" on page 332.

* Do not allow collisions at either end of the table traveling distance. Additionally, when running the positioning operation, do not set within 2 mm of both ends.

* For the manufacture of intermediate strokes, please contact SMC. (LEJS40/Manufacturable stroke range: 200 to 1200 mm, LEJS63/Manufacturable stroke range: 300 to 1500 mm)

Weight

Model	LEJS40									
Stroke [mm]	200	300	400	500	600	700	800	900	1000	1200
Product weight [kg]	5.6	6.4	7.1	7.9	8.7	9.4	10.2	11.0	11.7	13.3
Additional weight with lock [kg]	S2: 0.2/T6: 0.2									

Model	LEJS63									
Stroke [mm]	300	400	500	600	700	800	900	1000	1200	1500
Product weight [kg]	11.4	12.7	13.9	15.2	16.4	17.7	18.9	20.1	22.6	26.4
Additional weight with lock [kg]	S3: 0.4/T7: 0.4									

LEJS Series

AC Servo Motor

Construction

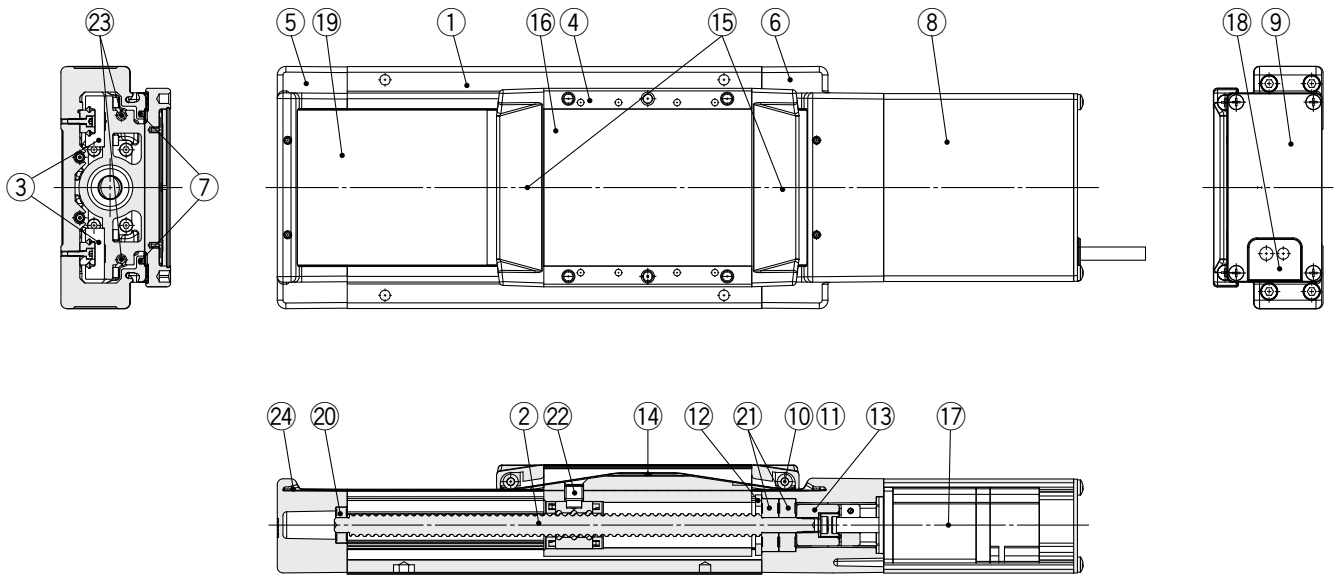

Component Parts

No	Description	Material	Note
1	Body	Aluminum alloy	Anodized
2	Ball screw assembly	—	
3	Linear guide assembly	—	
4	Table	Aluminum alloy	Anodized
5	Housing A	Aluminum alloy	Coating
6	Housing B	Aluminum alloy	Coating
7	Seal magnet	—	
8	Motor cover	Aluminum alloy	Anodized
9	End cover A	Aluminum alloy	Anodized
10	Roller shaft	Stainless steel	
11	Roller	Synthetic resin	
12	Bearing stopper	Carbon steel	

No	Description	Material	Note
13	Coupling	—	
14	Table cap	Synthetic resin	
15	Seal band holder	Synthetic resin	
16	Blanking plate	Aluminum alloy	Anodized
17	Motor	—	
18	Grommet	NBR	
19	Dust seal band	Stainless steel	
20	Bearing	—	
21	Bearing	—	
22	Nut fixing pin	Carbon steel	
23	Magnet	—	
24	Seal band stopper	Stainless steel	

Replacement Parts/Grease Pack

Applied portion	Order no.
Ball screw	GR-S-010 (10 g)
Linear guide	GR-S-020 (20 g)
Dust seal band	

Dimensions: Ball Screw Drive

LEJS40

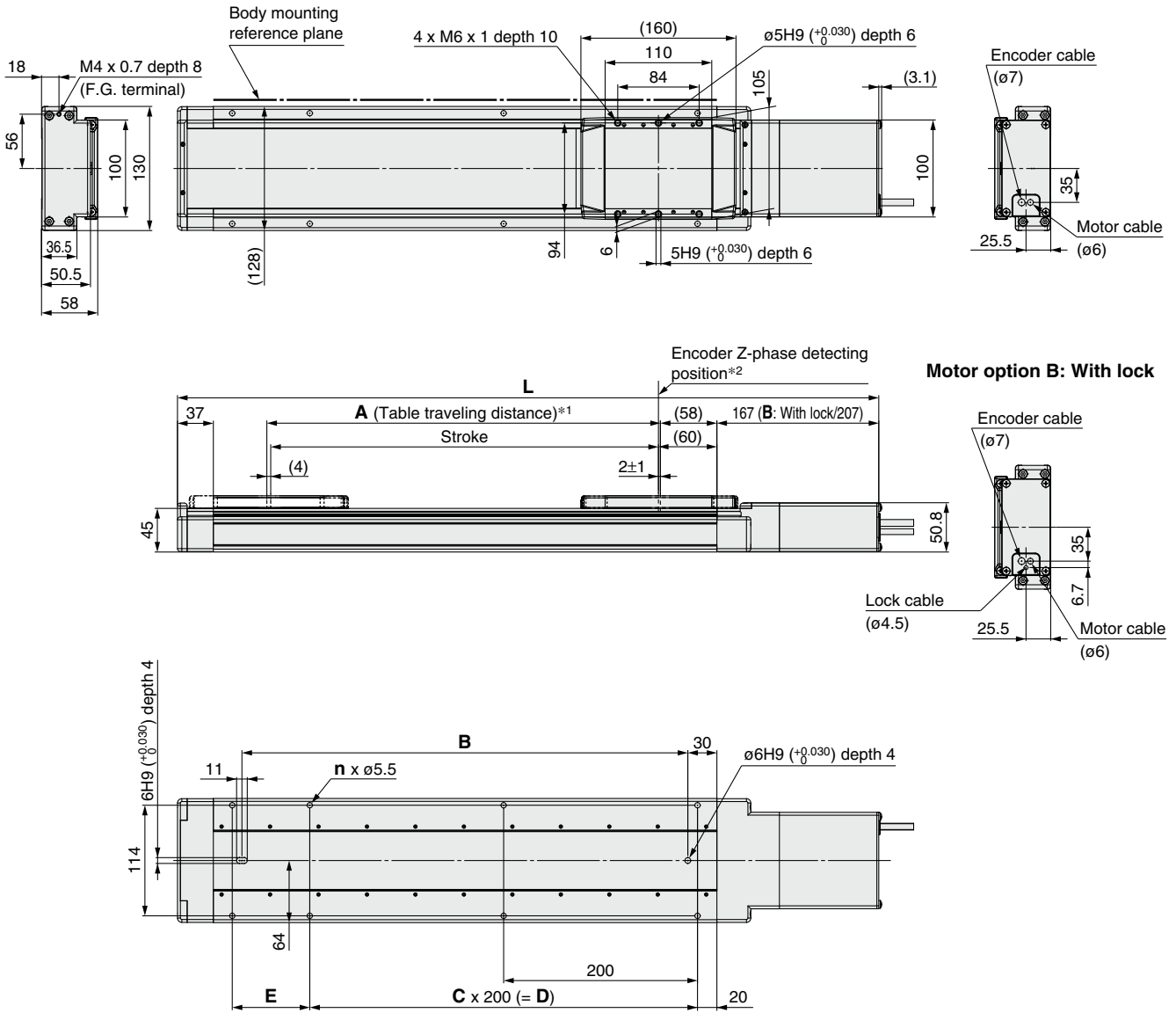

*1 This is the distance within which the table can move when it returns to origin. Make sure that workpieces mounted on the table do not interfere with other workpieces or the facilities around the table.

*2 The Z-phase first detecting position from the stroke end of the motor side

* The auto switch magnet is located in the table center.

Model	L		A	B	n	C	D	E
	Without lock	With lock						
LEJS□40□□□-200□-□□□□	523.5	563.5	206	260	6	1	200	80
LEJS□40□□□-300□-□□□□	623.5	663.5	306	360	6	1	200	180
LEJS□40□□□-400□-□□□□	723.5	763.5	406	460	8	2	400	80
LEJS□40□□□-500□-□□□□	823.5	863.5	506	560	8	2	400	180
LEJS□40□□□-600□-□□□□	923.5	963.5	606	660	10	3	600	80
LEJS□40□□□-700□-□□□□	1023.5	1063.5	706	760	10	3	600	180
LEJS□40□□□-800□-□□□□	1123.5	1163.5	806	860	12	4	800	80
LEJS□40□□□-900□-□□□□	1223.5	1263.5	906	960	12	4	800	180
LEJS□40□□□-1000□-□□□□	1323.5	1363.5	1006	1060	14	5	1000	80
LEJS□40□□□-1200□-□□□□	1523.5	1563.5	1206	1260	16	6	1200	80

LEJS Series

AC Servo Motor

Dimensions: Ball Screw Drive

LEJS63

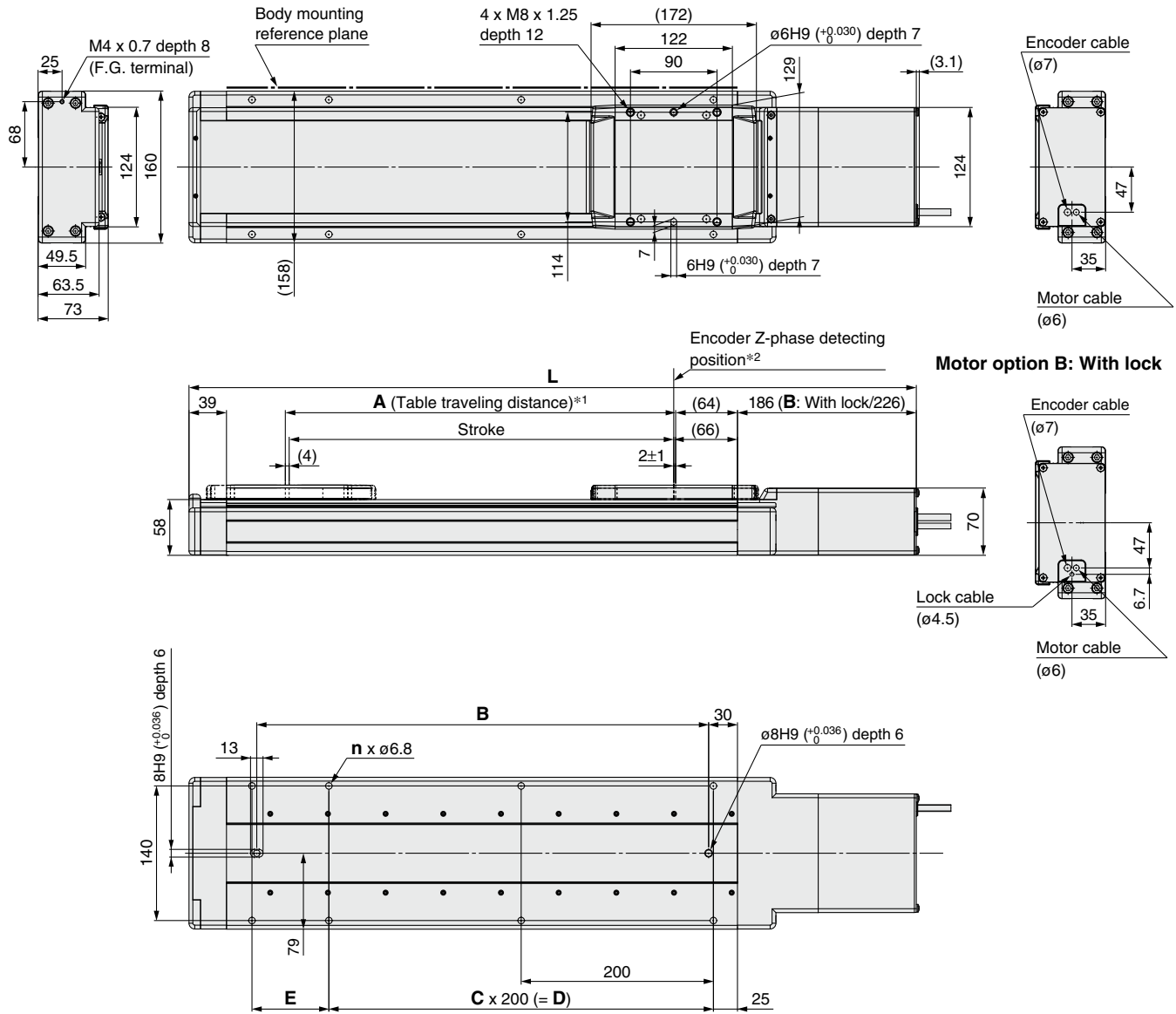

*1 This is the distance within which the table can move when it returns to origin. Make sure that workpieces mounted on the table do not interfere with other workpieces or the facilities around the table.

*2 The Z-phase first detecting position from the stroke end of the motor side

* The auto switch magnet is located in the table center.

Model	L		A	B	n	C	D	E
	Without lock	With lock						
LEJS□63□□□-300□-□□□□	656.5	696.5	306	370	6	1	200	180
LEJS□63□□□-400□-□□□□	756.5	796.5	406	470	8	2	400	80
LEJS□63□□□-500□-□□□□	856.5	896.5	506	570	8	2	400	180
LEJS□63□□□-600□-□□□□	956.5	996.5	606	670	10	3	600	80
LEJS□63□□□-700□-□□□□	1056.5	1096.5	706	770	10	3	600	180
LEJS□63□□□-800□-□□□□	1156.5	1196.5	806	870	12	4	800	80
LEJS□63□□□-900□-□□□□	1256.5	1296.5	906	970	12	4	800	180
LEJS□63□□□-1000□-□□□□	1356.5	1396.5	1006	1070	14	5	1000	80
LEJS□63□□□-1200□-□□□□	1556.5	1596.5	1206	1270	16	6	1200	80
LEJS□63□□□-1500□-□□□□	1856.5	1896.5	1506	1570	18	7	1400	180

Built-in Intermediate Supports Type

These specifications enable the maximum speed to be realized throughout the entire stroke.

High Rigidity Slider Type Ball Screw Drive

LEJS63□-□M Series

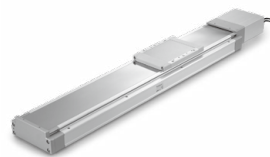

CE UK CA
* For details, refer to page 1343 and onward.

RoHS

Please contact SMC for clean room specification and the models compatible with secondary batteries.

Standard LEJS Series ▶ p. 305 LECY Series ▶ p. 322 Motorless Type ▶ p. 1221

How to Order

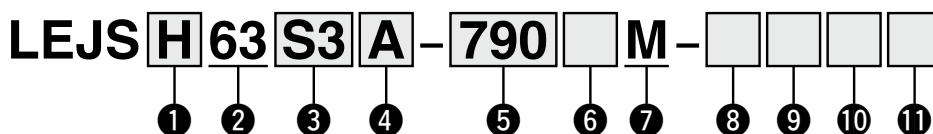

① Accuracy

Nil	Basic type
H	High-precision type

② Size

63

③ Motor type

Symbol	Type	Output [W]	② Size	⑩ Driver type	Compatible drivers
S3	AC servo motor (Incremental encoder)	200	63	A1/A2	LECSA□-S3
T7	AC servo motor (Absolute encoder)	200	63	B2	LECSB2-T7
				C2	LECSC2-T7
				S2	LECSS2-T7

④ Lead [mm]

H	30
A	20
B	10

⑤ Stroke [mm]*1

●: Standard ○: Produced upon receipt of order

790	890	990	1190	1490	1790
●	●	○	○	○	○

*1 Please contact SMC for non-standard strokes as they are produced upon receipt of order.

⑥ Motor option

Nil	Without option
B	With lock

⑦ Built-in intermediate supports

M	Built-in intermediate supports
---	--------------------------------

⑧ Cable type*2 *3

Nil	Without cable
S	Standard cable
R	Robotic cable

*2 When a driver type is selected, a cable is included. Select the cable type and cable length.

Example)

S2S2: Standard cable (2 m) + Driver (LECSS2)

S2: Standard cable (2 m)

Nil: Without cable and driver

*3 A motor cable and encoder cable are included with the product. (A lock cable is also included if motor option "B: With lock" is selected.)

⑨ Cable length*2 *4

Nil	Without cable
2	2
5	5
A	10

*4 The length of the motor, encoder, and lock cables are the same.

⑪ I/O connector*5

Nil	Without cable
H	Without cable (Connector only)
1	1.5 [m]

*5 When "Nil: Without driver" is selected, only "Nil: Without cable" can be selected.

⑩ Driver type*2

Symbol	Compatible drivers	Power supply voltage [V]
Nil	Without driver	—
A1	LECSA1-S□	100 to 120
A2	LECSA2-S□	200 to 230
B2	LECSB2-T□	200 to 240
C2	LECSC2-T□	200 to 230
S2	LECSS2-T□	200 to 240

Compatible Drivers

For auto switches, refer to pages 332 to 335.

Driver type	Pulse input type/ Positioning type	Pulse input type	CC-Link direct input type	SSCNET III/H type
Series	LECSA	LECSB-T	LECSC-T	LECSS-T
Number of point tables	Up to 7	Up to 255	Up to 255 (2 stations occupied)	—
Pulse input	○	○	—	—
Applicable network	—	—	CC-Link	SSCNET III/H
Control encoder	Incremental 17-bit encoder	Absolute 22-bit encoder	Absolute 18-bit encoder	Absolute 22-bit encoder
Communication function	USB communication	USB communication, RS422 communication	USB communication, RS422 communication	USB communication
Power supply voltage [V]	100 to 120 VAC (50/60 Hz) 200 to 230 VAC (50/60 Hz)	200 to 240 VAC (50/60 Hz)	200 to 230 VAC (50/60 Hz)	200 to 240 VAC (50/60 Hz)
Reference page	1109			

LEJS63□-□M Series

Specifications

		Lead [mm]			
Work load [kg]	Horizontal	30	20	10	
	Vertical	6	10	20	
Speed [mm/s]	Stroke range	790	1800	1200	600
		890			
		990			
		1190			
		1490			
1790					

For the model selection method, refer to page 289. Other specifications that are not listed are the same as those of the standard product. Refer to page 306 for details.

Construction

Top view of actuator (Shown with the dust seal band removed)

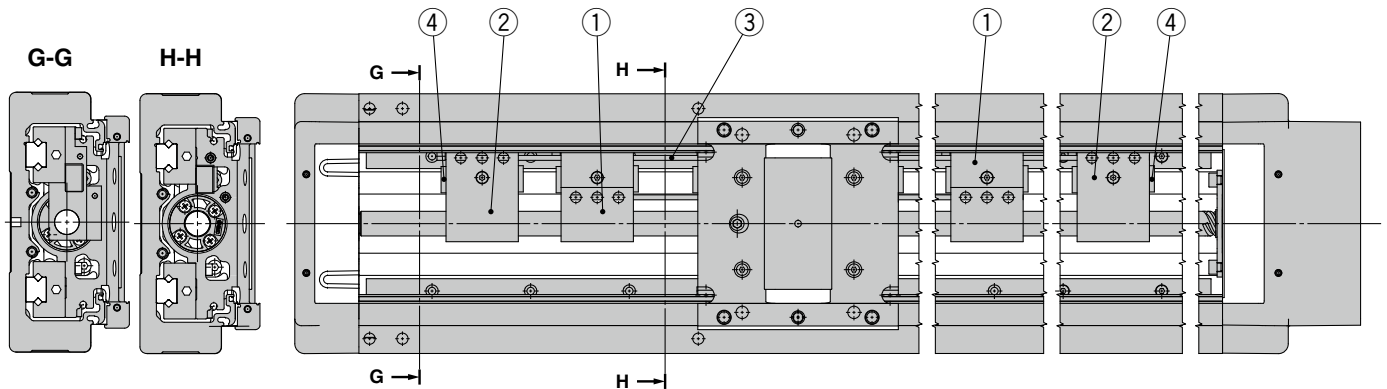

Component Parts

No.	Description	Material
1	Support A	Synthetic resin
2	Support B	Synthetic resin
3	Connection pipe	Stainless steel
4	Bumper	Low-elasticity rubber

Dimensions: Ball Screw Drive

AC servo motor

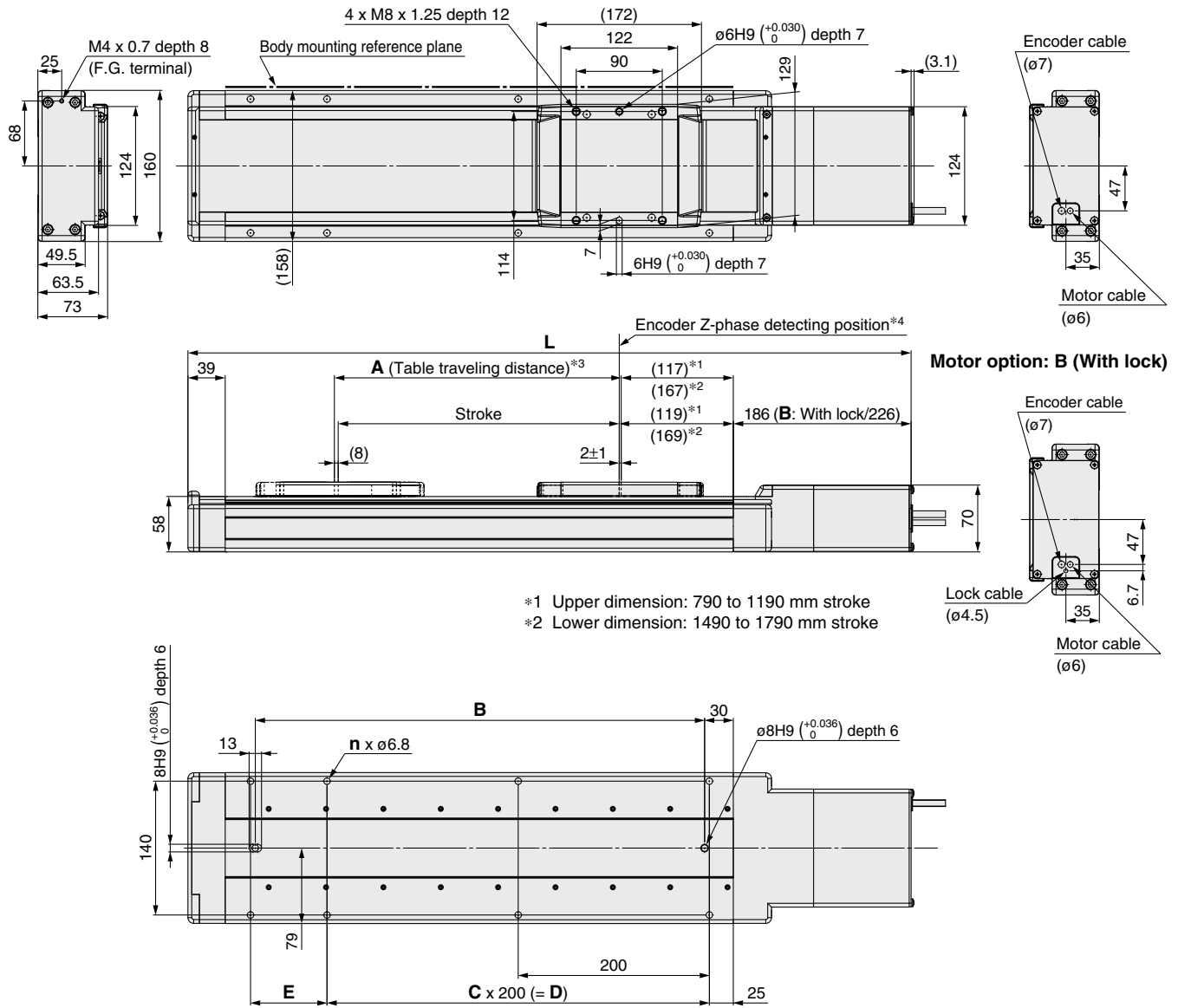

*1 Upper dimension: 790 to 1190 mm stroke
 *2 Lower dimension: 1490 to 1790 mm stroke

- *3 This is the distance within which the table can move when it returns to origin. Make sure that workpieces mounted on the table do not interfere with other workpieces or the facilities around the table.
- *4 The Z-phase first detecting position from the stroke end of the motor side
- * The auto switch magnet is located in the table center.

⚠ Caution

1. During operation, the intermediate support mechanism emits a collision noise due to the structure.
2. Compared to the standard product, the entire length of the product will be longer for each stroke. For details, refer to the dimensions.
3. The stopper type origin position return method cannot be used as the return to origin method (due to the bumper as shown in Construction ④).

Dimensions and Weight

Model	L		A	B	n	C	D	E	Product weight*1 [kg]
	Without lock	With lock							
LEJS□63□□-790□M-□□□□	1256.5	1296.5	800	970	12	4	800	180	19.4
LEJS□63□□-890□M-□□□□	1356.5	1396.5	900	1070	14	5	1000	80	20.7
LEJS□63□□-990□M-□□□□	1456.5	1496.5	1000	1170	14	5	1000	180	21.9
LEJS□63□□-1190□M-□□□□	1656.5	1696.5	1200	1370	16	6	1200	180	24.4
LEJS□63□□-1490□M-□□□□	2056.5	2096.5	1500	1770	20	8	1600	180	29.9
LEJS□63□□-1790□M-□□□□	2356.5	2396.5	1800	2070	24	10	2000	80	33.7

*1 When using a lock, add 0.4 (incremental encoder) or 0.7 (absolute encoder).

High Rigidity Slider Type Ball Screw Drive

LEJS100-X400



* For details, refer to page 1343 and onward.

How to Order

LEJS 100 T9 B - 500 T - - - - X400

① ② ③ ④ ⑤ ⑥ ⑦ ⑧ ⑨

• With top cover type

① Size

100

② Motor type

Symbol	Type	Output [W]	① Size	⑧ Driver type	Compatible drivers
T9	AC servo motor (Absolute encoder)	750	100	B2	LECSB2-T9
				C2	LECSC2-T9
				S2	LECSS2-T9

③ Lead [mm]

H	50
A	25
B	10

④ Stroke [mm]*1

200
to
1500

*1 Refer to the applicable stroke table for details.

⑤ Motor option

Nil	Without option
B	With lock

⑥ Cable type*3 *4

Nil	Without cable
S	Standard cable
R	Robotic cable

*3 When a driver type is selected, a cable is included. Select the cable type and cable length.

Example)

S2B2: Standard cable (2 m) + Driver (LECSB2)

S2 : Standard cable (2 m)

Nil : Without cable and driver

*4 A motor cable and encoder cable are included with the product. (A lock cable is also included if motor option "B: With lock" is selected.)

⑧ Driver type*3

	Compatible driver Model	Power supply voltage [V]	Control method
Nil	Without driver	—	—
B2	LECSB2-T9	200 to 240	Pulse input/Point table
C2	LECSC2-T9	200 to 230	CC-Link
S2	LECSS2-T9	200 to 240	SSCNET III/H

Applicable Stroke Table*2

●: Standard

Model	Stroke [mm]								
	200	300	400	500	600	800	1000	1200	1500
LEJS100	●	●	●	●	●	●	●	●	●

*2 Please contact SMC for non-standard strokes as they are produced as special orders.

⑦ Cable length [m]*5

Nil	Without cable
2	2
5	5
A	10

*5 The length of the motor, encoder, and lock cables are the same.



⑨ I/O cable length [m]*6

Nil	Without cable
H	Connector only
1	1.5

*6 When "Nil: Without driver" is selected for the driver type, only "Nil: Without cable" can be selected.

For auto switches, refer to pages 332 to 335.

Compatible Drivers

Driver type	Pulse input type	CC-Link direct input type	SSCNET III/H type
			
Series	LECSB-T	LECSC-T	LECSS-T
Number of point tables	Up to 255	Up to 255 (2 stations occupied)	—
Pulse input	○	—	—
Applicable network	—	CC-Link	SSCNET III/H
Control encoder	Absolute 22-bit encoder	Absolute 18-bit encoder	Absolute 22-bit encoder
Communication function	USB communication, RS422 communication	USB communication, RS422 communication	USB communication
Power supply voltage [V]	200 to 240 VAC (50/60 Hz)	200 to 230 VAC (50/60 Hz)	200 to 240 VAC (50/60 Hz)

Specifications

Actuator specifications	Stroke [mm]*1		200, 300, 400, 500, 600, 800, 1000, 1200, 1500			
	Lead [mm]		50	25	10	
	Work load*2 [kg]	Horizontal	3000 (mm/s ²)	60	150	400
			5000 (mm/s ²)	43	93	150
			10000 (mm/s ²)	22	36	—
		Vertical	3000 (mm/s ²)	14	29	80
			5000 (mm/s ²)	12	29	30
			10000 (mm/s ²)	8	9	—
	Max. speed*3 [mm/s]	Stroke range	200 to 800	2300	1250	500
			1000	1600	800	320
			1200	1200	600	240
			1500	900	450	180
	Max. acceleration/deceleration [mm/s ²]		10000			
	Positioning repeatability [mm]		±0.01			
	Lost motion [mm]*4		0.05 or less			
Impact/Vibration resistance [m/s ²]*5		50/20				
Actuation type		Ball screw				
Guide type		Linear guide				
Static allowable moment*6 [N·m]	Mep (Pitching)		805			
	Mey (Yawing)		771			
	Mer (Rolling)		939			
Operating temperature range [°C]		5 to 40				
Operating humidity range [%RH]		90 or less (No condensation)				
Enclosure		IP30				
Regeneration option		May be required depending on speed and work load. (Refer to page 300.)				
Electric specifications	Motor output [W]/Size [mm]		750/□80			
	Motor type		AC servo motor (200 VAC)			
	Encoder		Absolute 22-bit encoder (Resolution: 4194304 p/rev)			
Lock unit specifications	Power [W]*7		Max. power 1100			
	Type*8		Non-magnetizing lock			
	Holding force [N]		240	480	1200	
Power consumption [W] at 20°C		10				
Rated voltage [V]		24 VDC ⁰ _{-10%}				

*1 Strokes other than those listed in the table above are available as special orders. Please contact SMC for further details.

*2 For details, refer to the "Speed-Work Load Graph (Guide)" on page 300.

*3 The allowable speed changes according to the stroke.

*4 A reference value for correcting errors in reciprocal operation

*5 Impact resistance: No malfunction occurred when the actuator was tested with a drop tester in both an axial direction and a perpendicular direction to the lead screw. (The test was performed with the actuator in the initial state.)

Vibration resistance: No malfunction occurred in a test ranging between 45 to 2000 Hz. The test was performed in both an axial direction and a perpendicular direction to the lead screw. (The test was performed with the actuator in the initial state.)

*6 The static allowable moment is the amount of static moment which can be applied to the actuator when it is stopped.

If the product is exposed to impact or repeated load, be sure to take adequate safety measures when using the product.

*7 Indicates the max. power during operation (including the driver)

When selecting the power supply capacity, refer to the power supply capacity in the operation manual of each driver.

*8 Only when motor option "With lock" is selected

* Do not allow collisions at either end of the table traveling distance. Additionally, when running the positioning operation, do not set within 7 mm of both ends.

LEJS100-X400

AC Servo Motor

Construction

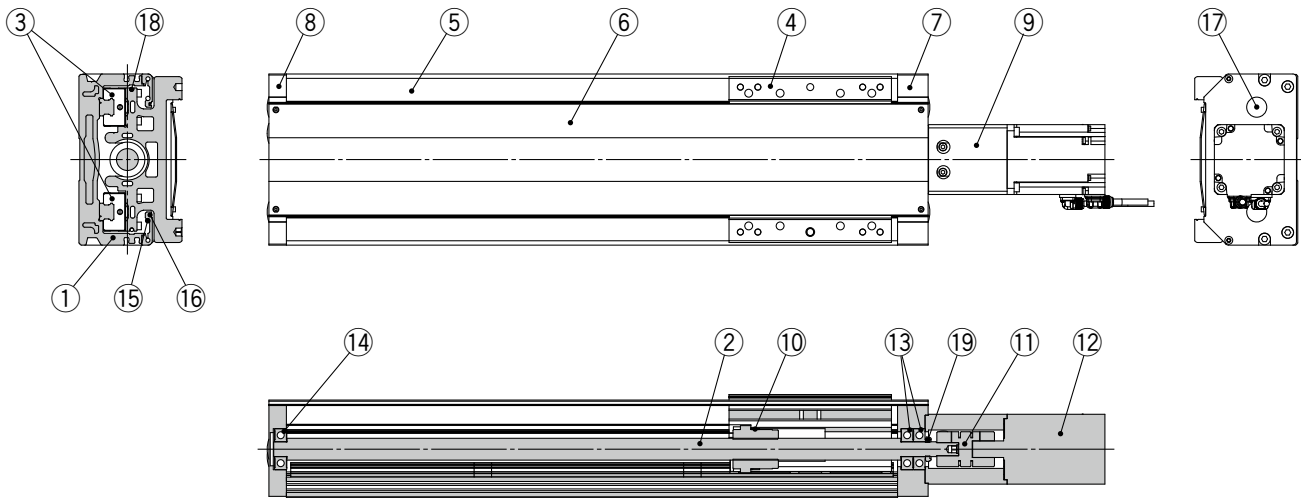

Component Parts

No.	Description	Material	Note
1	Body	Aluminum alloy	Anodized
2	Ball screw assembly	—	
3	Linear guide assembly	—	
4	Table	Aluminum alloy	Anodized
5	Side cover	Aluminum alloy	Anodized
6	Dust cover	Aluminum alloy	Anodized
7	Plate M	Aluminum alloy	Anodized
8	Plate E	Aluminum alloy	Anodized
9	Motor block	Aluminum alloy	Anodized
10	Spacer	Aluminum alloy	"Lead: H" only
11	Coupling	—	
12	Motor	—	
13	Bearing	—	
14	Bearing	—	
15	Pin	Carbon steel	
16	Pin	Carbon steel	
17	Cap	Polyethylene	
18	Magnet	—	
19	Lock nut	—	

Replacement Parts/Grease Pack

Applied portion	Order no.
Ball screw	GR-S-010 (10 g)
Linear guide portion	GR-S-020 (20 g)

Dimensions: Ball Screw Drive

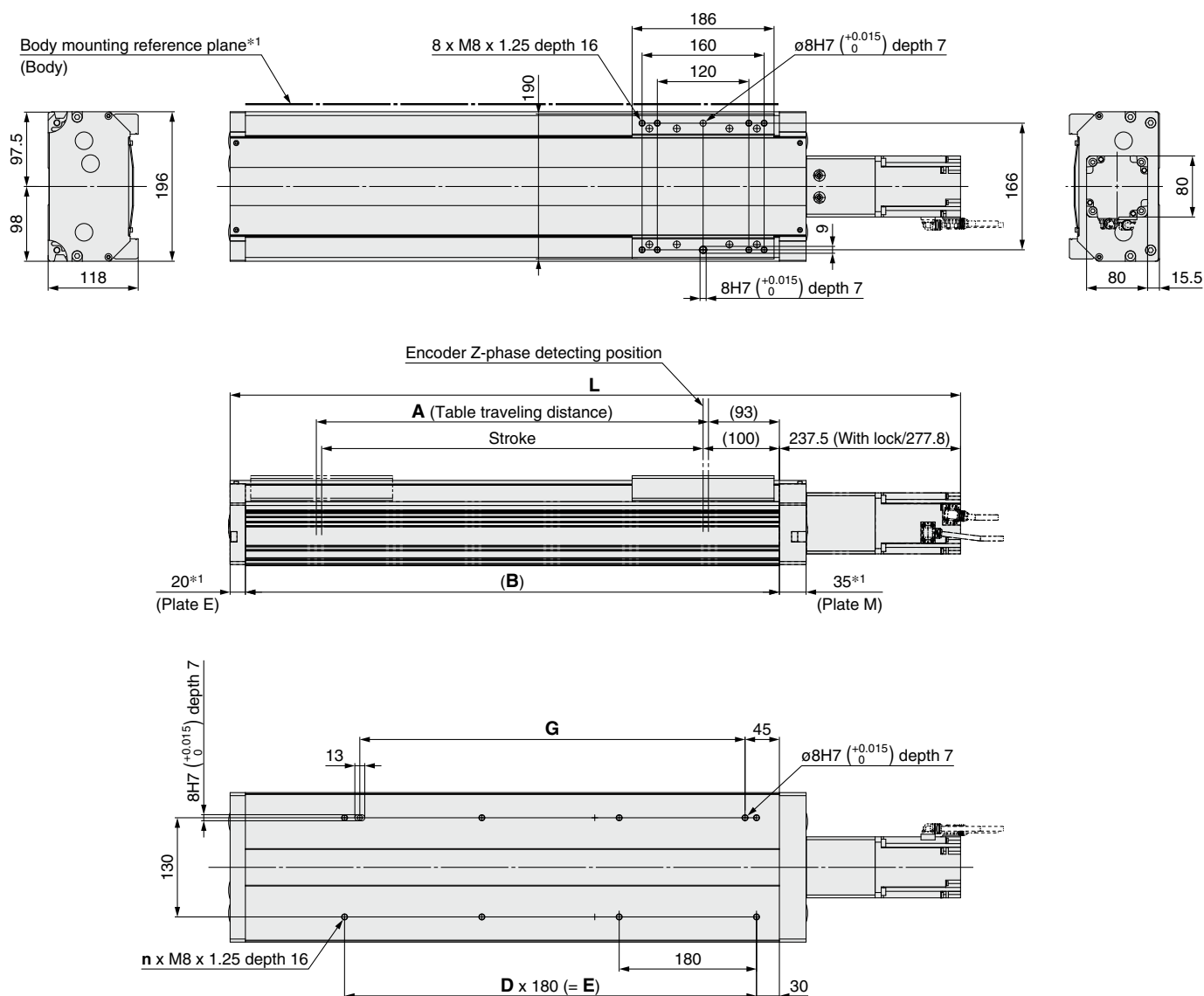

*1 When mounting the actuator using the body mounting reference plane, set the height of the opposite surface or pin to be 5 mm or more. (Recommended height: 6 mm)

The surfaces of plates M and E on the ends of the product may slightly protrude from the body mounting reference plane (Body/B dimension range). Be sure to provide a clearance of 1 mm or more to avoid interference.

* Please contact SMC for adjusting the Z-phase detecting position at the stroke end of the end side.

Dimensions and Weight

Model	L		A	B	n	D	E	G	Weight [kg]	
	Without lock	With lock							Without lock	With lock
LEJS100T9□-200□T-□□□□-X400	657.5	697.8	214	400	6	2	360	325	20.4	21.4
LEJS100T9□-300□T-□□□□-X400	757.5	797.8	314	500	6	2	360	325	22.5	23.5
LEJS100T9□-400□T-□□□□-X400	857.5	897.8	414	600	8	3	540	505	24.6	25.6
LEJS100T9□-500□T-□□□□-X400	957.5	997.8	514	700	8	3	540	505	26.7	27.7
LEJS100T9□-600□T-□□□□-X400	1057.5	1097.8	614	800	10	4	720	685	28.8	29.8
LEJS100T9□-800□T-□□□□-X400	1257.5	1297.8	814	1000	12	5	900	865	33.0	34.0
LEJS100T9□-1000□T-□□□□-X400	1457.5	1497.8	1014	1200	14	6	1080	1045	37.1	38.1
LEJS100T9□-1200□T-□□□□-X400	1657.5	1697.8	1214	1400	16	7	1260	1225	41.3	42.3
LEJS100T9□-1500□T-□□□□-X400	1957.5	1997.8	1514	1700	20	9	1620	1585	47.6	48.6

LEJS100-X400

AC Servo Motor

Side Supports

Side supports: MY-S50A

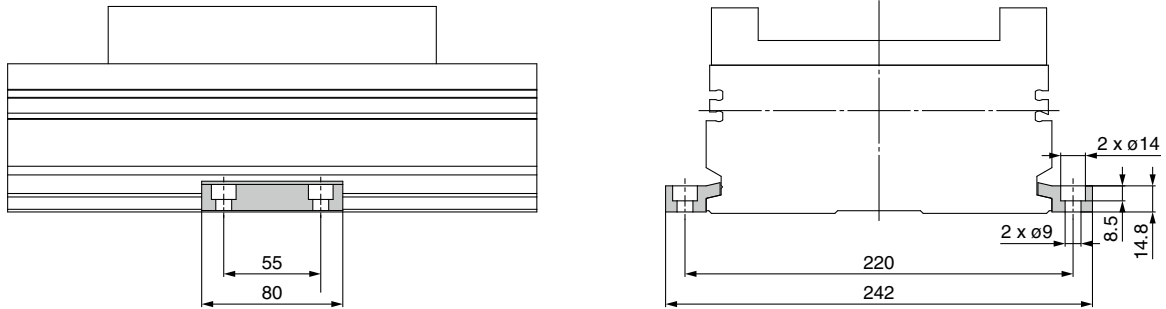

* The side supports consist of a set of right and left brackets.

Usage Guide for Side Supports

When mounting with the side supports, be sure to use the number of side supports (N) and the support spacing (L1) shown in the figure and table below as a guide.

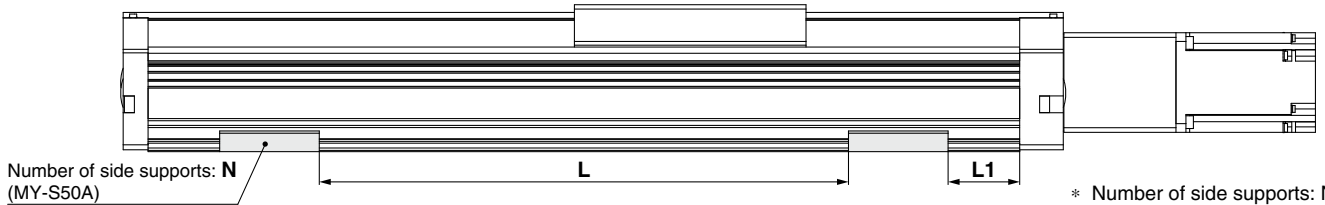

* Number of side supports: N is the combined number of left and right supports.

Stroke	N (Qty.)	L1 [mm]	Screw size	Max. tightening torque [N·m]
200	6	15	M8 x 1.25	12.5
300	6			
400	6			
500	6			
600	8			
800	8			
1000	10			
1200	10			
1500	14			

- Secure the side supports using the support spacing (L) in the table above.
- When mounting with the side supports, use in combination with the pin on the bottom of the body.
- For vertical or bottom mounting, please refrain from using only the side supports.

High Rigidity Slider Type Ball Screw Drive

LEJS Series LEJS40, 63



* For details, refer to page 1343 and onward.

Please contact SMC for clean room specification and the models compatible with secondary batteries.

Built-in Intermediate Supports Type ▶ p. 322 **LECS** Series ▶ p. 305 **Clean Room Specification** ▶ p. 969 **Secondary Battery Compatible** ▶ p. 982 **Motorless Type** ▶ p. 1213

How to Order

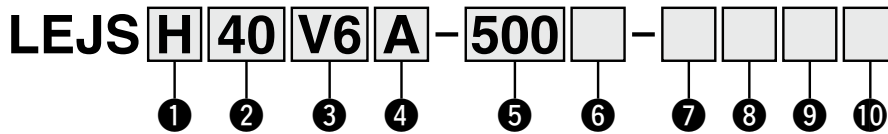

1 Accuracy

Nil	Basic type
H	High-precision type

2 Size

40
63

3 Motor type*1

Symbol	Type	Output [W]	2 Size	9 Driver type	Compatible drivers
V6	AC servo motor (Absolute encoder)	100	40	M2	LECYM2-V5
		200		63	U2
V7	AC servo motor (Absolute encoder)	100	40	M2	LECYM2-V7
		200		63	U2

*1 For motor type V6, the compatible driver part number suffix is V5.

4 Lead [mm]

Symbol	LEJS40	LEJS63
H	24	30
A	16	20
B	8	10

5 Stroke [mm]*2

200
to
1500

*2 Refer to the applicable stroke table for details.

6 Motor option

Nil	Without option
B	With lock

7 Cable type*4 *5

Nil	Without cable
S	Standard cable
R	Robotic cable

*5 A motor cable and encoder cable are included with the product. (A lock cable is also included if motor option "B: With lock" is selected.)

8 Cable length [m]*4 *6

Nil	Without cable
3	3
5	5
A	10
C	20

*6 The length of the motor, encoder, and lock cables are the same.

9 Driver type*4

	Compatible drivers	Power supply voltage [V]
Nil	Without driver	—
M2	LECYM2-V□	200 to 230
U2	LECYU2-V□	200 to 230

10 I/O cable length*7

Nil	Without cable
H	Without cable (Connector only)
1	1.5 [m]

*7 When "Nil: Without driver" is selected for the driver type, only "Nil: Without cable" can be selected. Refer to page 1135 if an I/O cable is required. (Options are shown on page 1135.)

Applicable Stroke Table*3

●: Standard

Model \ Stroke [mm]	200	300	400	500	600	700	800	900	1000	1200	1500
LEJS40	●	●	●	●	●	●	●	●	●	●	—
LEJS63	—	●	●	●	●	●	●	●	●	●	●

*3 Please contact SMC for non-standard strokes as they are produced as special orders.

For auto switches, refer to pages 332 to 335.

Compatible Drivers

Driver type	MECHATROLINK-II type	MECHATROLINK-III type
Series	LECYM	LECYU
Applicable network	MECHATROLINK-II	MECHATROLINK-III
Control encoder	Absolute 20-bit encoder	
Communication device	USB communication, RS-422 communication	
Power supply voltage [V]	200 to 230 VAC (50/60 Hz)	
Reference page	1128	

Specifications

AC Servo Motor (100/200 W)

Model		LEJS40V6			LEJS63V7				
Actuator specifications	Stroke [mm]*1	200, 300, 400, 500, 600, 700, 800 900, 1000, 1200			300, 400, 500, 600, 700, 800, 900 1000, 1200, 1500				
	Work load [kg]*2	Horizontal	15	30	55	30	45	85	
		Vertical	3	5	10	6	10	20	
	Speed*3 [mm/s]	Stroke range	Up to 500	1800	1200	600	1800	1200	600
			501 to 600	1580	1050	520	1800	1200	600
			601 to 700	1170	780	390	1800	1200	600
			701 to 800	910	600	300	1390	930	460
			801 to 900	720	480	240	1110	740	370
			901 to 1000	580	390	190	900	600	300
			1001 to 1100	480	320	160	750	500	250
			1101 to 1200	410	270	130	630	420	210
			1201 to 1300	—	—	—	540	360	180
	1301 to 1400	—	—	—	470	310	150		
	1401 to 1500	—	—	—	410	270	130		
	Max. acceleration/deceleration [mm/s ²]		20000 (Refer to pages 293 and 294 for limit according to work load and duty ratio.)						
Positioning repeatability [mm]	Basic type	±0.02							
	High-precision type	±0.01							
Lost motion [mm]*4	Basic type	0.1 or less							
	High-precision type	0.05 or less							
Lead [mm]		24	16	8	30	20	10		
Impact/Vibration resistance [m/s ²]*5		50/20							
Actuation type		Ball screw							
Guide type		Linear guide							
Static allowable moment*6 [N·m]	Mep (Pitching)	83.9			121.5				
	Mey (Yawing)	88.2			135.1				
	Mer (Rolling)	88.2			135.1				
Operating temperature range [°C]		5 to 40							
Operating humidity range [%RH]		90 or less (No condensation)							
Enclosure		IP30							
Regenerative resistor		May be required depending on speed and work load. (Refer to page 304.)							
Electric specifications	Motor output [W]/Size [mm]	100□40			200□60				
	Motor type	AC servo motor (200 VAC)							
	Encoder	Absolute 20-bit encoder (Resolution: 1048576 p/rev)							
	Power [W]*7	Max. power 445			Max. power 725				
Lock unit specifications	Type*8	Non-magnetizing lock							
	Holding force [N]	67	101	202	108	162	324		
	Power consumption at 20°C [W]	5.5			6				
	Rated voltage [V]	24 VDC ^{+10%} ₀							

*1 Please contact SMC for non-standard strokes as they are produced as special orders.

*2 Check the "Speed-Work Load Graph (Guide)" on page 304.

*3 The allowable speed changes according to the stroke.

*4 A reference value for correcting errors in reciprocal operation

*5 Impact resistance: No malfunction occurred when the actuator was tested with a drop tester in both an axial direction and a perpendicular direction to the lead screw. (The test was performed with the actuator in the initial state.)

Vibration resistance: No malfunction occurred in a test ranging between 45 to 2000 Hz. The test was performed in both an axial direction and a perpendicular direction to the lead screw. (The test was performed with the actuator in the initial state.)

*6 The static allowable moment is the amount of static moment which can be applied to the actuator when it is stopped.

If the product is exposed to impact or repeated load, be sure to take adequate safety measures when using the product.

*7 Indicates the max. power during operation (including the driver) When selecting the power supply capacity, refer to the power supply capacity in the operation manual of each driver.

*8 Only when motor option "With lock" is selected

* Sensor magnet position is located in the table center. For detailed dimensions, refer to the "Auto Switch Mounting Position."

* Do not allow collisions at either end of the table traveling distance. Additionally, when running the positioning operation, do not set within 2 mm of both ends.

* For the manufacture of intermediate strokes, please contact SMC. (LEJS40/Manufacturable stroke range: 200 to 1200 mm, LEJS63/Manufacturable stroke range: 300 to 1500 mm)

Weight

Model	LEJS40									
Stroke [mm]	200	300	400	500	600	700	800	900	1000	1200
Product weight [kg]	5.6	6.4	7.1	7.9	8.7	9.4	10.2	11.0	11.7	13.3
Additional weight with lock [kg]	0.3 (Absolute encoder)									

Model	LEJS63									
Stroke [mm]	300	400	500	600	700	800	900	1000	1200	1500
Product weight [kg]	11.4	12.7	13.9	15.2	16.4	17.7	18.9	20.1	22.6	26.4
Additional weight with lock [kg]	0.7 (Absolute encoder)									

Dimensions: Ball Screw Drive

LEJS40

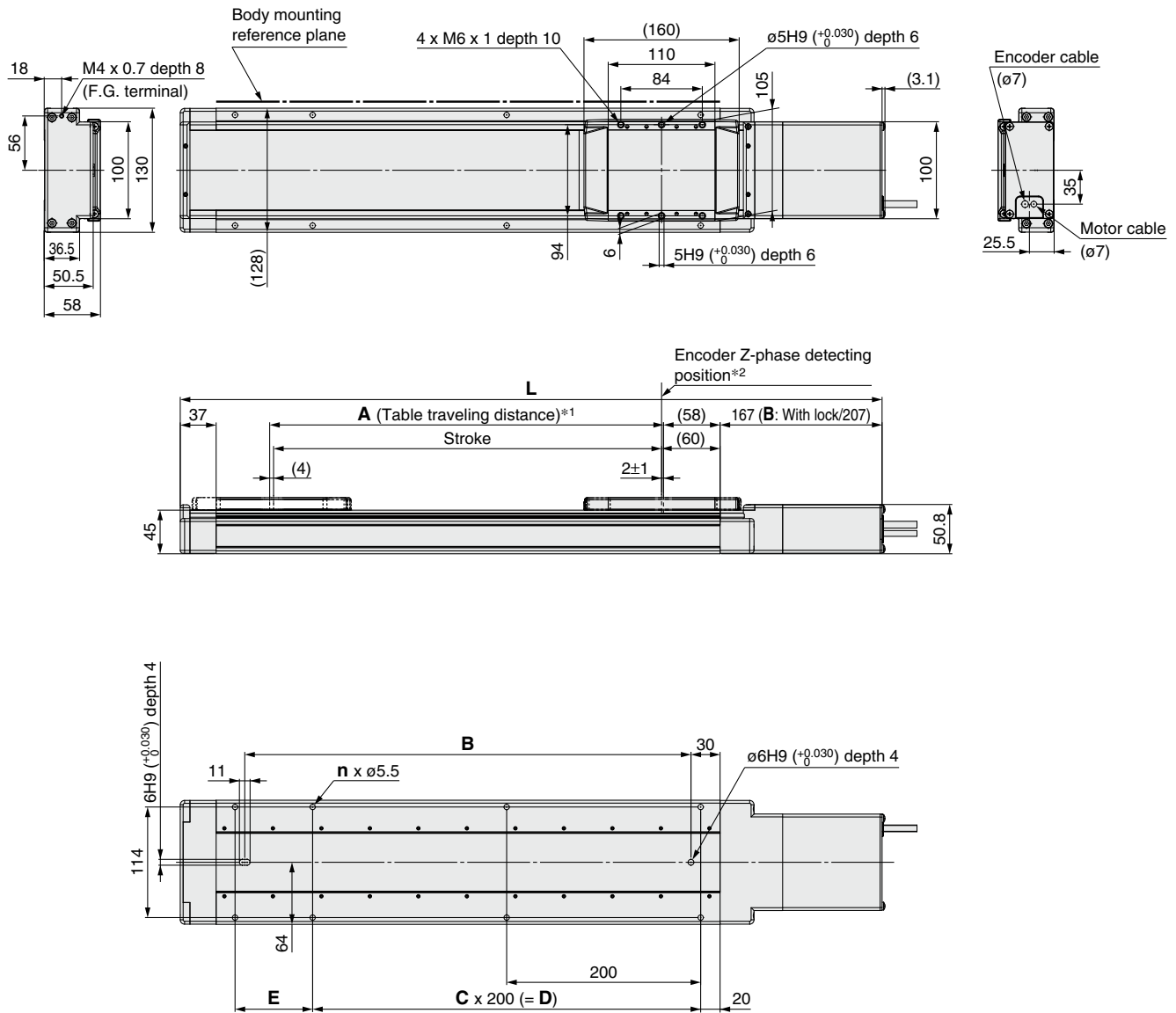

*1 This is the distance within which the table can move when it returns to origin. Make sure that workpieces mounted on the table do not interfere with other workpieces or the facilities around the table.

*2 The Z-phase first detecting position from the stroke end of the motor side

* The auto switch magnet is located in the table center.

Model	L		A	B	n	C	D	E
	Without lock	With lock						
LEJS40V□□-200□-□□□□	523.5	563.5	206	260	6	1	200	80
LEJS40V□□-300□-□□□□	623.5	663.5	306	360	6	1	200	180
LEJS40V□□-400□-□□□□	723.5	763.5	406	460	8	2	400	80
LEJS40V□□-500□-□□□□	823.5	863.5	506	560	8	2	400	180
LEJS40V□□-600□-□□□□	923.5	963.5	606	660	10	3	600	80
LEJS40V□□-700□-□□□□	1023.5	1063.5	706	760	10	3	600	180
LEJS40V□□-800□-□□□□	1123.5	1163.5	806	860	12	4	800	80
LEJS40V□□-900□-□□□□	1223.5	1263.5	906	960	12	4	800	180
LEJS40V□□-1000□-□□□□	1323.5	1363.5	1006	1060	14	5	1000	80
LEJS40V□□-1200□-□□□□	1523.5	1563.5	1206	1260	16	6	1200	80

LEJS Series

AC Servo Motor

Dimensions: Ball Screw Drive

LEJS63

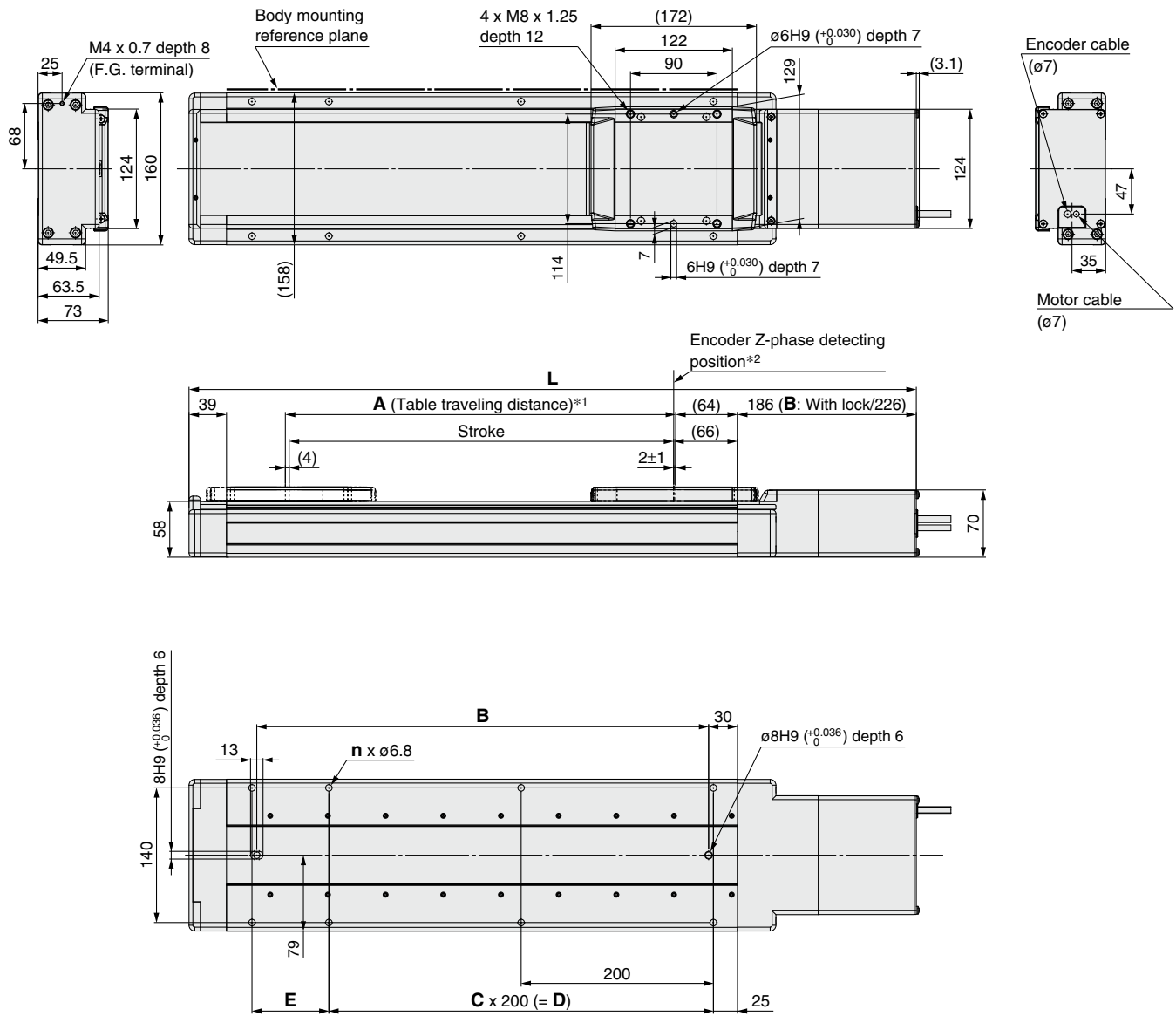

*1 This is the distance within which the table can move when it returns to origin. Make sure that workpieces mounted on the table do not interfere with other workpieces or the facilities around the table.

*2 The Z-phase first detecting position from the stroke end of the motor side

* The auto switch magnet is located in the table center.

Model	L		A	B	n	C	D	E
	Without lock	With lock						
LEJS63V□□-300□-□□□□	656.5	696.5	306	370	6	1	200	180
LEJS63V□□-400□-□□□□	756.5	796.5	406	470	8	2	400	80
LEJS63V□□-500□-□□□□	856.5	896.5	506	570	8	2	400	180
LEJS63V□□-600□-□□□□	956.5	996.5	606	670	10	3	600	80
LEJS63V□□-700□-□□□□	1056.5	1096.5	706	770	10	3	600	180
LEJS63V□□-800□-□□□□	1156.5	1196.5	806	870	12	4	800	80
LEJS63V□□-900□-□□□□	1256.5	1296.5	906	970	12	4	800	180
LEJS63V□□-1000□-□□□□	1356.5	1396.5	1006	1070	14	5	1000	80
LEJS63V□□-1200□-□□□□	1556.5	1596.5	1206	1270	16	6	1200	80
LEJS63V□□-1500□-□□□□	1856.5	1896.5	1506	1570	18	7	1400	180

Built-in Intermediate Supports Type

These specifications enable the maximum speed to be realized throughout the entire stroke.

High Rigidity Slider Type Ball Screw Drive

LEJS63□-□M Series

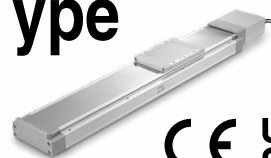

* For details, refer to page 1343 and onward.

Please contact SMC for clean room specification and the models compatible with secondary batteries.

Standard LEJS Series ▶ p. 318 LECS□ Series ▶ p. 310

For the model selection method, refer to page 303, and for details on the specifications, construction, and dimensions, refer to page 311 and onward.

How to Order

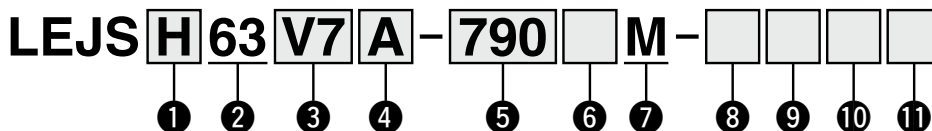

① Accuracy

Nil	Basic type
H	High-precision type

② Size

63

③ Motor type

Symbol	Type	Output [W]	② Size	⑩ Driver type	Compatible drivers
V7	AC servo motor (Absolute encoder)	200	63	M2	LECYM2-V7
				U2	LECYU2-V7

④ Lead [mm]

H	30
A	20
B	10

⑤ Stroke [mm]*1

●: Standard ○: Produced upon receipt of order

790	890	990	1190	1490	1790
●	●	○	○	○	○

*1 Please contact SMC for non-standard strokes as they are produced upon receipt of order.

⑥ Motor option

Nil	Without option
B	With lock

⑦ Built-in intermediate supports

M	Built-in intermediate supports
---	--------------------------------

⑧ Cable type*2 *3

Nil	Without cable
S	Standard cable
R	Robotic cable

*2 When a driver type is selected, a cable is included. Select the cable type and cable length.

*3 A motor cable and encoder cable are included with the product. (A lock cable is also included if motor option "B: With lock" is selected.)

⑨ Cable length*2 *4

Nil	Without cable
3	3
5	5
A	10
C	20

*4 The length of the motor, encoder, and lock cables are the same.



⑪ I/O connector*5

Nil	Without cable
H	Without cable (Connector only)
1	1.5 [m]

*5 When "Nil: Without driver" is selected, only "Nil: Without cable" can be selected.

For auto switches, refer to pages 332 to 335.

Compatible Drivers

Driver type	MECHATROLINK-II type	MECHATROLINK-III type
		
Series	LECYM	LECYU
Applicable network	MECHATROLINK-II	MECHATROLINK-III
Control encoder	Absolute 20-bit encoder	
Communication device	USB communication, RS-422 communication	
Power supply voltage [V]	200 to 230 VAC (50/60 Hz)	
Reference page	1128	

High Rigidity Slider Type Belt Drive

LEJB Series



LECY □ Series ▶ p. 328



* For details, refer to page 1343 and onward.

How to Order

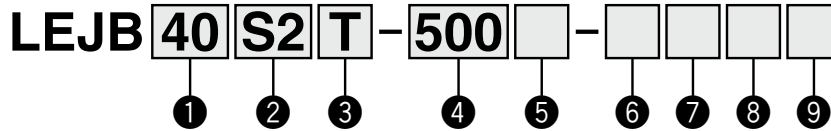

① Size

40
63

③ Lead [mm]

Symbol	LEJB40	LEJB63
T	27	42

④ Stroke [mm]*3

200
to
3000

*3 Refer to the applicable stroke table for details.

⑤ Motor option

Nil	Without option
B	With lock

⑥ Cable type*5 *6 *7

Nil	Without cable
S	Standard cable
R	Robotic cable

*6 A motor cable and encoder cable are included with the product. (A lock cable is also included if motor option "B: With lock" is selected.)

*7 Standard cable entry direction is "(A) Axis side." (Refer to page 1126 for details.)

② Motor type

Symbol	Type	Output [W]	① Size	⑧ Driver type	Compatible drivers
*1 S2	AC servo motor (Incremental encoder)	100	40	A1/A2	LECSA □-S1
S3		200	63	A1/A2	LECSA □-S3
*2 T6	AC servo motor (Absolute encoder)	100	40	B2	LECSB2-T5
T7				C2	LECSC2-T5
		200	63	B2	LECSB2-T7
C2				LECSC2-T7	
S2	LECSS2-T7				

*1 For motor type S2, the compatible driver part number suffix is S1.

*2 For motor type T6, the compatible driver part number is LECS □-T5.

⑦ Cable length [m]*5 *8

Nil	Without cable
2	2
5	5
A	10

*8 The length of the motor, encoder, and lock cables are the same.

⑨ I/O cable length*9

Nil	Without cable
H	Without cable (Connector only)
1	1.5 [m]

*9 When "Nil: Without driver" is selected for the driver type, only "Nil: Without cable" can be selected. Refer to page 1124 if an I/O cable is required. (Options are shown on page 1124.)

⑧ Driver type*5

	Compatible drivers	Power supply voltage [V]
Nil	Without driver	—
A1	LECSA1	100 to 120
A2	LECSA2	200 to 230
B2	LECSB2-T □	200 to 240
C2	LECSC2-T □	200 to 230
S2	LECSS2-T □	200 to 240

*5 When a driver type is selected, a cable is included. Select the cable type and cable length.
Example)
S2S2: Standard cable (2 m) + Driver (LECSS2)
S2: Standard cable (2 m)
Nil: Without cable and driver

Applicable Stroke Table*4

●: Standard

Model	Stroke [mm]	200	300	400	500	600	700	800	900	1000	1200	1500	2000	3000
LEJB40		●	●	●	●	●	●	●	●	●	●	●	●	—
LEJB63		—	●	●	●	●	●	●	●	●	●	●	●	●

*4 Please contact SMC for non-standard strokes as they are produced as special orders.

For auto switches, refer to pages 332 to 335.

Compatible Drivers

Driver type	Pulse input type/ Positioning type	Pulse input type	CC-Link direct input type	SSCNET III/H type
Series	LECSA	LECSB-T	LECSC-T	LECST-T
Number of point tables	Up to 7	Up to 255	Up to 255 (2 stations occupied)	—
Pulse input	○	○	—	—
Applicable network	—	—	CC-Link	SSCNET III/H
Control encoder	Incremental 17-bit encoder	Absolute 22-bit encoder	Absolute 18-bit encoder	Absolute 22-bit encoder
Communication function	USB communication	USB communication, RS422 communication	USB communication, RS422 communication	USB communication
Power supply voltage [V]	100 to 120 VAC (50/60 Hz) 200 to 230 VAC (50/60 Hz)	200 to 240 VAC (50/60 Hz)	200 to 230 VAC (50/60 Hz)	200 to 240 VAC (50/60 Hz)
Reference page	1109			

Specifications

AC Servo Motor

Model		LEJB40S2/T6				LEJB63S3/T7				
Actuator specifications	Stroke [mm]*1	200, 300, 400, 500, 600, 700, 800 900, 1000, 1200, 1500, 2000				300, 400, 500, 600, 700, 800 900, 1000, 1200, 1500, 2000, 3000				
	Work load [kg]	Horizontal 20 (If the stroke exceeds 1000 mm: 10)				30				
	Speed [mm/s]*2	2000				3000				
	Max. acceleration/deceleration [mm/s ²]	20000 (Refer to page 295 for limit according to work load and duty ratio.)								
	Positioning repeatability [mm]	±0.04								
	Lost motion [mm]*3	0.1 or less								
	Lead [mm]	27				42				
	Impact/Vibration resistance [m/s ²]*4	50/20								
	Actuation type	Belt								
	Guide type	Linear guide								
	Static allowable moment*5 [N·m]	Mep (Pitching)	83.9				121.5			
		Mey (Yawing)	88.2				135.1			
		Mer (Rolling)	88.2				135.1			
	Allowable external force [N]	20								
	Operating temperature range [°C]	5 to 40								
Operating humidity range [%RH]	90 or less (No condensation)									
Enclosure	IP30									
Regeneration option	May be required depending on speed and work load. (Refer to page 290.)									
Motor output [W]/Size [mm]	100□40				200□60					
Motor type	AC servo motor (100/200 VAC)									
Encoder*6	Motor type S2, S3: Incremental 17-bit encoder (Resolution: 131072 p/rev) Motor type T6, T7: Absolute 22-bit encoder (Resolution: 4194304 p/rev) (For LECSB-T□, LECSST-T□) Motor type T6, T7: Absolute 18-bit encoder (Resolution: 262144 p/rev) (For LECSCT-T□)									
Power [W]*7	Max. power 445				Max. power 725					
Type*8	Non-magnetizing lock									
Holding force [N]	60				157					
Power consumption at 20°C [W]	6.3				7.9					
Rated voltage [V]	24 VDC ⁰ _{-10%}									

*1 Please contact SMC for non-standard strokes as they are produced as special orders.

*2 For details, refer to the "Speed-Work Load Graph (Guide)" on page 290.

*3 A reference value for correcting errors in reciprocal operation

*4 Impact resistance: No malfunction occurred when the actuator was tested with a drop tester in both an axial direction and a perpendicular direction to the lead screw. (The test was performed with the actuator in the initial state.)

Vibration resistance: No malfunction occurred in a test ranging between 45 to 2000 Hz. The test was performed in both an axial direction and a perpendicular direction to the lead screw. (The test was performed with the actuator in the initial state.)

*5 The static allowable moment is the amount of static moment which can be applied to the actuator when it is stopped.

If the product is exposed to impact or repeated load, be sure to take adequate safety measures when using the product.

*6 The resolution will change depending on the driver type.

*7 Indicates the max. power during operation (including the driver)

When selecting the power supply capacity, refer to the power supply capacity in the operation manual of each driver.

*8 Only when motor option "With lock" is selected

* Sensor magnet position is located in the table center.

For detailed dimensions, refer to the "Auto Switch Mounting Position" on page 332.

* Do not allow collisions at either end of the table traveling distance. Additionally, when running the positioning operation, do not set within 2 mm of both ends.

* For the manufacture of intermediate strokes, please contact SMC.

(LEJB40/Manufacturable stroke range: 200 to 2000 mm, LEJB63/Manufacturable stroke range: 300 to 3000 mm)

Weight

Model	LEJB40											
Stroke [mm]	200	300	400	500	600	700	800	900	1000	1200	1500	2000
Product weight [kg]	5.7	6.4	7.1	7.7	8.4	9.1	9.8	10.5	11.2	12.6	14.7	18.1
Additional weight with lock [kg]	S2: 0.2/T6: 0.2											

Model	LEJB63											
Stroke [mm]	300	400	500	600	700	800	900	1000	1200	1500	2000	3000
Product weight [kg]	11.5	12.7	13.8	15.0	16.2	17.4	18.6	19.7	22.1	25.7	31.6	43.4
Additional weight with lock [kg]	S3: 0.4/T7: 0.4											

LEJB Series

AC Servo Motor

Construction

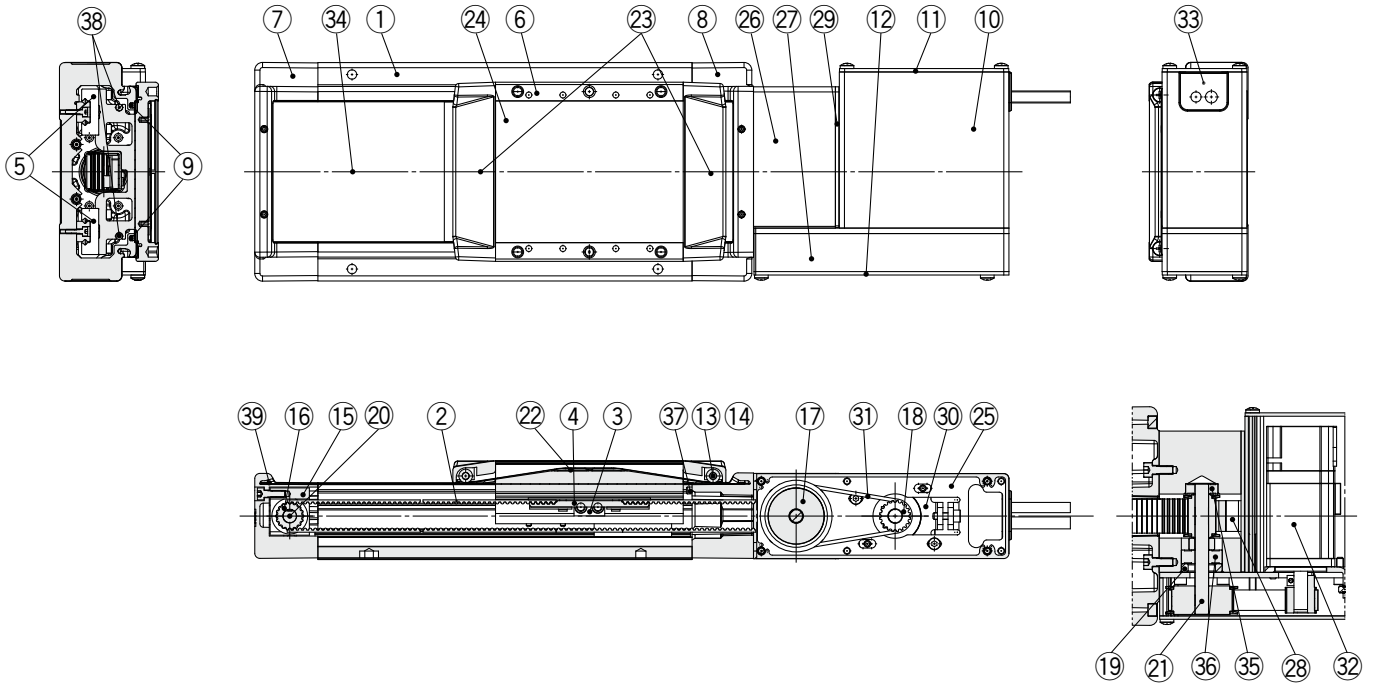

Motor details

Component Parts

No.	Description	Material	Note
1	Body	Aluminum alloy	Anodized
2	Belt	—	
3	Belt holder	Carbon steel	
4	Belt stopper	Aluminum alloy	
5	Linear guide assembly	—	
6	Table	Aluminum alloy	Anodized
7	Housing A	Aluminum alloy	Coating
8	Housing B	Aluminum alloy	Coating
9	Seal magnet	—	
10	Motor cover	Aluminum alloy	Anodized
11	End cover A	Aluminum alloy	Anodized
12	End cover B	Aluminum alloy	Anodized
13	Roller shaft	Stainless steel	
14	Roller	Synthetic resin	
15	Pulley holder	Aluminum alloy	
16	Drive pulley	Aluminum alloy	
17	Speed reduction pulley	Aluminum alloy	
18	Motor pulley	Aluminum alloy	
19	Spacer	Aluminum alloy	
20	Pulley shaft A	Stainless steel	
21	Pulley shaft B	Stainless steel	
22	Table cap	Synthetic resin	

No.	Description	Material	Note
23	Seal band holder	Synthetic resin	
24	Blanking plate	Aluminum alloy	Anodized
25	Motor mount plate	Carbon steel	
26	Pulley block	Aluminum alloy	Anodized
27	Pulley cover	Aluminum alloy	Anodized
28	Belt stopper	Aluminum alloy	
29	Side plate	Aluminum alloy	Anodized
30	Motor plate	Carbon steel	
31	Belt	—	
32	Motor	—	
33	Grommet	NBR	
34	Dust seal band	Stainless steel	
35	Bearing	—	
36	Bearing	—	
37	Stopper pin	Stainless steel	
38	Magnet	—	
39	Seal band stopper	Stainless steel	

Replacement Parts/Grease Pack

Applied portion	Order no.
Linear guide	GR-S-010 (10 g)
Dust seal band	GR-S-020 (20 g)

Dimensions: Belt Drive

LEJB40

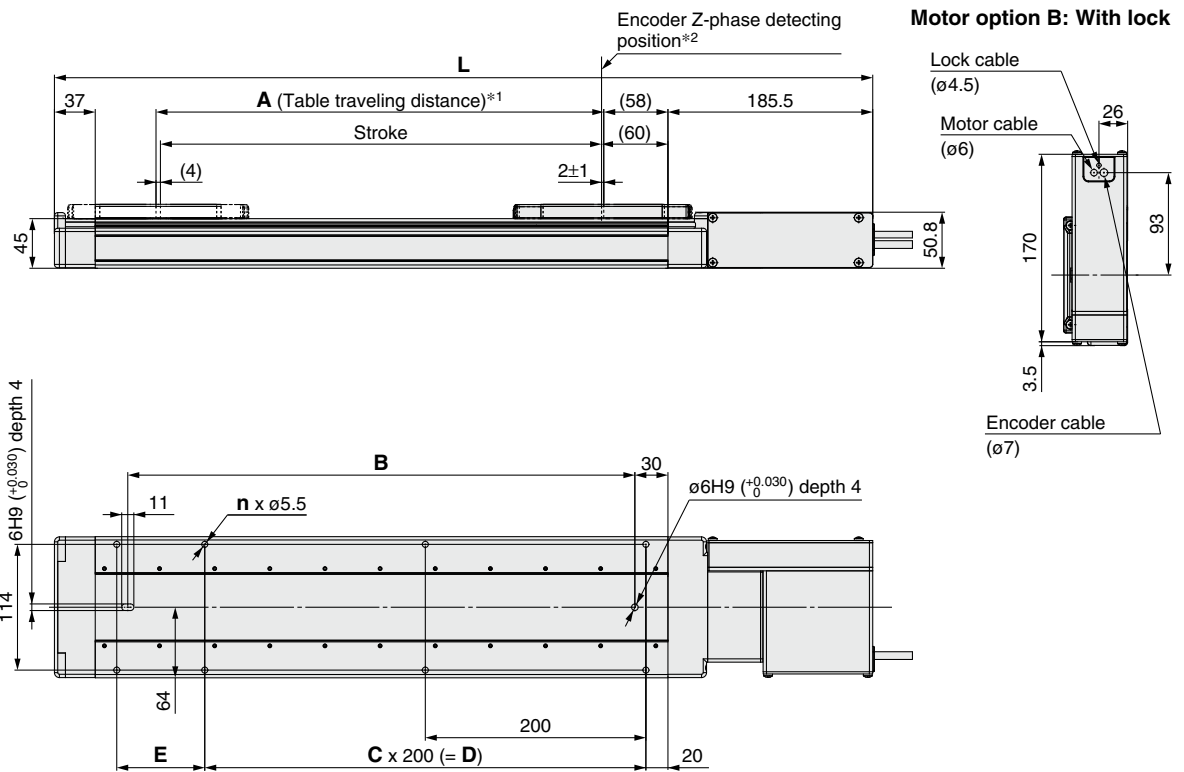
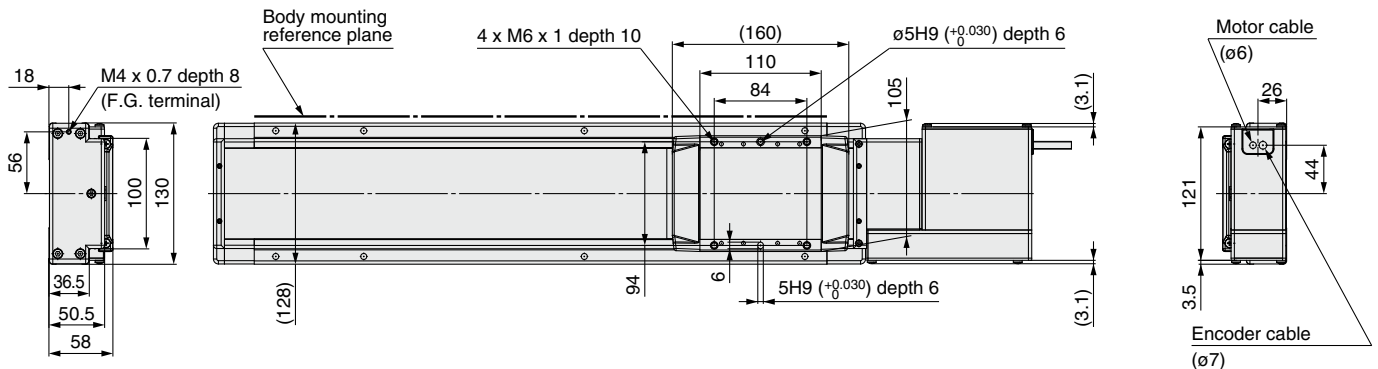

*1 This is the distance within which the table can move when it returns to origin. Make sure that workpieces mounted on the table do not interfere with other workpieces or the facilities around the table.

*2 The Z-phase first detecting position from the stroke end of the motor side

* The auto switch magnet is located in the table center.

Model	L	A	B	n	C	D	E
LEJB40□□□-200□-□□□□	542	206	260	6	1	200	80
LEJB40□□□-300□-□□□□	642	306	360	6	1	200	180
LEJB40□□□-400□-□□□□	742	406	460	8	2	400	80
LEJB40□□□-500□-□□□□	842	506	560	8	2	400	180
LEJB40□□□-600□-□□□□	942	606	660	10	3	600	80
LEJB40□□□-700□-□□□□	1042	706	760	10	3	600	180
LEJB40□□□-800□-□□□□	1142	806	860	12	4	800	80
LEJB40□□□-900□-□□□□	1242	906	960	12	4	800	180
LEJB40□□□-1000□-□□□□	1342	1006	1060	14	5	1000	80
LEJB40□□□-1200□-□□□□	1542	1206	1260	16	6	1200	80
LEJB40□□□-1500□-□□□□	1842	1506	1560	18	7	1400	180
LEJB40□□□-2000□-□□□□	2342	2006	2060	24	10	2000	80

LEJB Series

AC Servo Motor

Dimensions: Belt Drive

LEJB63

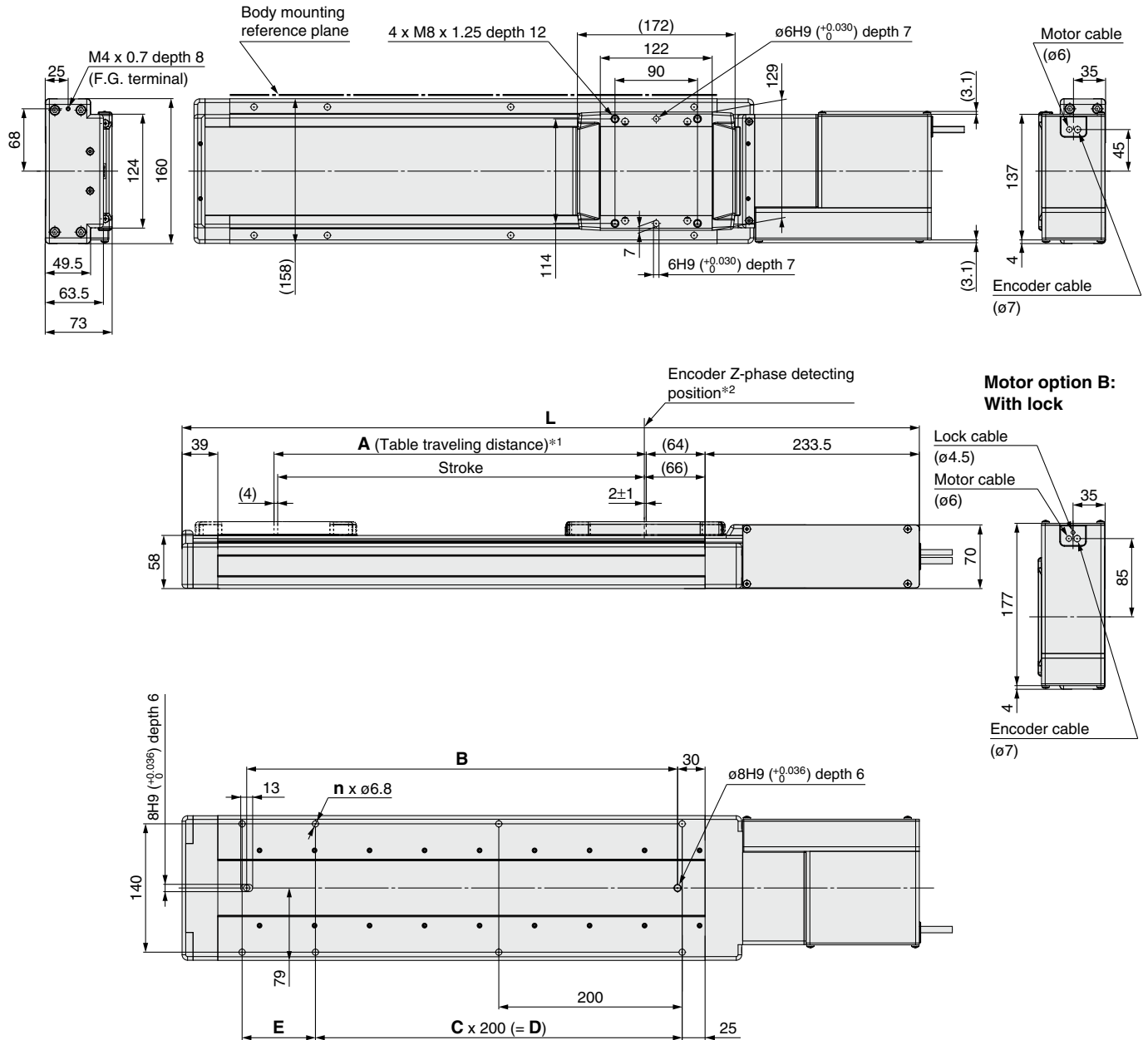

*1 This is the distance within which the table can move when it returns to origin. Make sure that workpieces mounted on the table do not interfere with other workpieces or the facilities around the table.

*2 The Z-phase first detecting position from the stroke end of the motor side

* The auto switch magnet is located in the table center.

Model	L	A	B	n	C	D	E
LEJB63□□□-300□-□□□□	704	306	370	6	1	200	180
LEJB63□□□-400□-□□□□	804	406	470	8	2	400	80
LEJB63□□□-500□-□□□□	904	506	570	8	2	400	180
LEJB63□□□-600□-□□□□	1004	606	670	10	3	600	80
LEJB63□□□-700□-□□□□	1104	706	770	10	3	600	180
LEJB63□□□-800□-□□□□	1204	806	870	12	4	800	80
LEJB63□□□-900□-□□□□	1304	906	970	12	4	800	180
LEJB63□□□-1000□-□□□□	1404	1006	1070	14	5	1000	80
LEJB63□□□-1200□-□□□□	1604	1206	1270	16	6	1200	80
LEJB63□□□-1500□-□□□□	1904	1506	1570	18	7	1400	180
LEJB63□□□-2000□-□□□□	2404	2006	2070	24	10	2000	80
LEJB63□□□-3000□-□□□□	3404	3006	3070	34	15	3000	80

High Rigidity Slider Type Belt Drive

LEJB Series LEJB40, 63



LECS Series ▶ p. 323



* For details, refer to page 1343 and onward.

How to Order

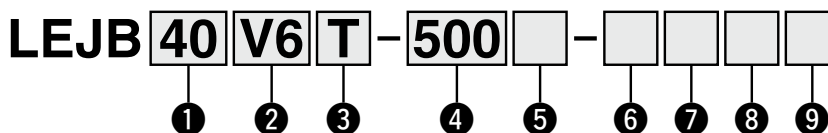

① Size

40
63

② Motor type*1

Symbol	Type	Output [W]	① Size	⑧ Driver type	Compatible drivers
V6	AC servo motor (Absolute encoder)	100	40	M2	LECYM2-V5
		200	63	U2	LECYU2-V5
V7				M2	LECYM2-V7
				U2	LECYU2-V7

*1 For motor type V6, the compatible driver part number suffix is V5.

③ Lead [mm]

Symbol	LEJB40	LEJB63
T	27	42

④ Stroke [mm]*2

200
to
3000

*2 Refer to the applicable stroke table for details.

⑤ Motor option

Nil	Without option
B	With lock

⑥ Cable type*4 *5

Nil	Without cable
S	Standard cable
R	Robotic cable

*5 A motor cable and encoder cable are included with the product. (A lock cable is also included if motor option "B: With lock" is selected.)

⑦ Cable length [m]*4 *6

Nil	Without cable
3	3
5	5
A	10
C	20

*6 The length of the motor, encoder, and lock cables are the same.

⑧ Driver type*4

	Compatible drivers	Power supply voltage [V]
Nil	Without driver	—
M2	LECYM2-V□	200 to 230
U2	LECYU2-V□	200 to 230

⑨ I/O cable length*7

Nil	Without cable
H	Without cable (Connector only)
1	1.5 [m]

*7 When "Nil: Without driver" is selected for the driver type, only "Nil: Without cable" can be selected. Refer to page 1135 if an I/O cable is required. (Options are shown on page 1135.)

Applicable Stroke Table*3

●: Standard

Model	Stroke [mm]	200	300	400	500	600	700	800	900	1000	1200	1500	2000	3000
LEJB40		●	●	●	●	●	●	●	●	●	●	●	●	—
LEJB63		—	●	●	●	●	●	●	●	●	●	●	●	●

*3 Please contact SMC for non-standard strokes as they are produced as special orders.

For auto switches, refer to pages 332 to 335.

Compatible Drivers

Driver type	MECHATROLINK-II type	MECHATROLINK-III type
Series	LECYM	LECYU
Applicable network	MECHATROLINK-II	MECHATROLINK-III
Control encoder	Absolute 20-bit encoder	
Communication device	USB communication, RS-422 communication	
Power supply voltage [V]	200 to 230 VAC (50/60 Hz)	
Reference page	1128	

LEJB Series

AC Servo Motor

Specifications

AC Servo Motor

Model		LEJB40V6	LEJB63V7	
Actuator specifications	Stroke [mm]*1	200, 300, 400, 500, 600, 700, 800 900, 1000, 1200, 1500, 2000	300, 400, 500, 600, 700, 800 900, 1000, 1200, 1500, 2000, 3000	
	Work load [kg]	20 (If the stroke exceeds 1000 mm: 10)	30	
	Speed [mm/s]*2	2000	3000	
	Max. acceleration/deceleration [mm/s ²]	20000 (Refer to page 295 for limit according to work load and duty ratio.)		
	Positioning repeatability [mm]	±0.04		
	Lost motion [mm]*3	0.1 or less		
	Lead [mm]	27	42	
	Impact/Vibration resistance [m/s ²]*4	50/20		
	Actuation type	Belt		
	Guide type	Linear guide		
	Static allowable moment*5 [N·m]	Mep (Pitching)	83.9	121.5
		Mey (Yawing)	88.2	135.1
		Mer (Rolling)	88.2	135.1
	Allowable external force [N]	20		
	Operating temperature range [°C]	5 to 40		
Operating humidity range [%RH]	90 or less (No condensation)			
Enclosure	IP30			
Regenerative resistor	May be required depending on speed and work load. (Refer to page 304.)			
Electric specifications	Motor output [W]/Size [mm]	100/□40	200/□60	
	Motor type	AC servo motor (200 VAC)		
	Encoder	Absolute 20-bit encoder (Resolution: 1048576 p/rev)		
	Power [W]*6	Max. power 445	Max. power 725	
Lock unit specifications	Type*7	Non-magnetizing lock		
	Holding force [N]	59	77	
	Power consumption at 20°C [W]	5.5	6	
	Rated voltage [V]	24 VDC ^{+10%} ₀		

*1 Please contact SMC for non-standard strokes as they are produced as special orders.

*2 Check the "Speed-Work Load Graph (Guide)" on page 304.

*3 A reference value for correcting errors in reciprocal operation

*4 Impact resistance: No malfunction occurred when the actuator was tested with a drop tester in both an axial direction and a perpendicular direction to the lead screw. (The test was performed with the actuator in the initial state.)

Vibration resistance: No malfunction occurred in a test ranging between 45 to 2000 Hz. The test was performed in both an axial direction and a perpendicular direction to the lead screw. (The test was performed with the actuator in the initial state.)

*5 The static allowable moment is the amount of static moment which can be applied to the actuator when it is stopped.

If the product is exposed to impact or repeated load, be sure to take adequate safety measures when using the product.

*6 Indicates the max. power during operation (including the driver)

When selecting the power supply capacity, refer to the power supply capacity in the operation manual of each driver.

*7 Only when motor option "With lock" is selected

* Sensor magnet position is located in the table center.

For detailed dimensions, refer to the "Auto Switch Mounting Position."

* Do not allow collisions at either end of the table traveling distance. Additionally, when running the positioning operation, do not set within 2 mm of both ends.

* For the manufacture of intermediate strokes, please contact SMC.

(LEJB40/Manufacturable stroke range: 200 to 2000 mm, LEJB63/Manufacturable stroke range: 300 to 3000 mm)

Weight

Model	LEJB40											
Stroke [mm]	200	300	400	500	600	700	800	900	1000	1200	1500	2000
Product weight [kg]	5.7	6.4	7.1	7.7	8.4	9.1	9.8	10.5	11.2	12.6	14.7	18.1
Additional weight with lock [kg]	0.3 (Absolute encoder)											

Model	LEJB63											
Stroke [mm]	300	400	500	600	700	800	900	1000	1200	1500	2000	3000
Product weight [kg]	11.5	12.7	13.8	15.0	16.2	17.4	18.6	19.7	22.1	25.7	31.6	43.4
Additional weight with lock [kg]	0.7 (Absolute encoder)											

Dimensions: Belt Drive

LEJB40

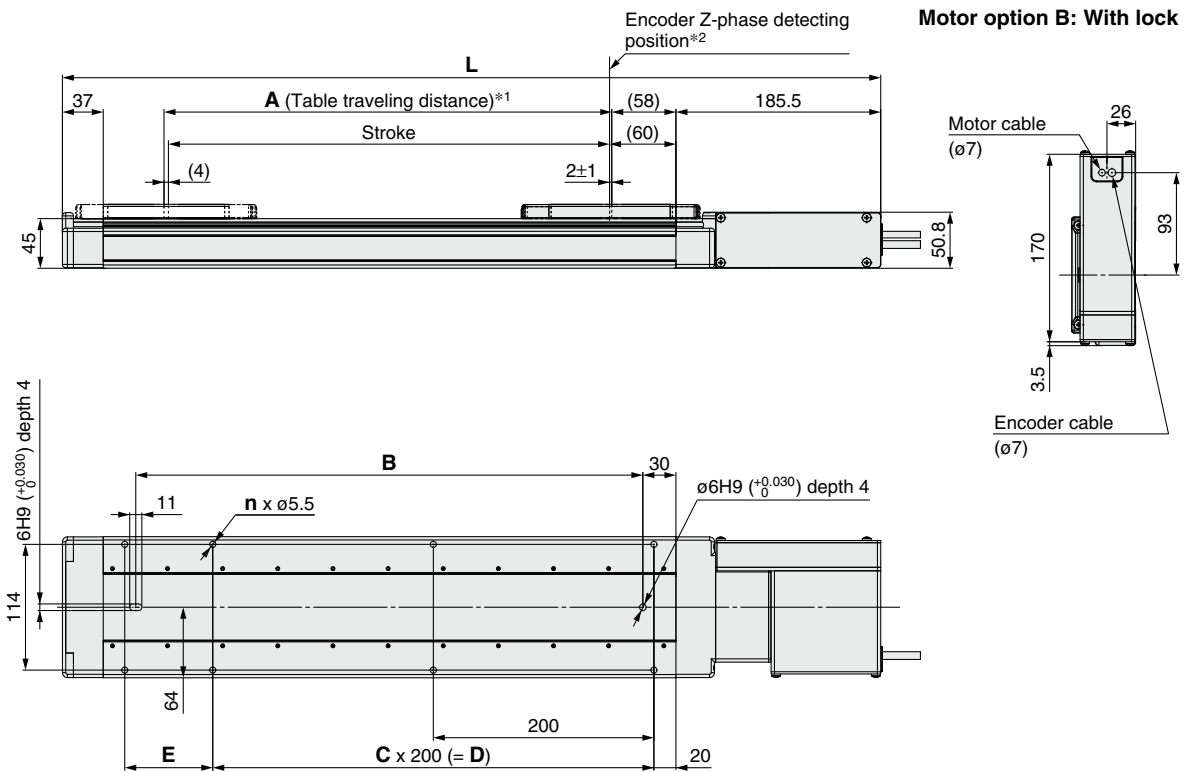
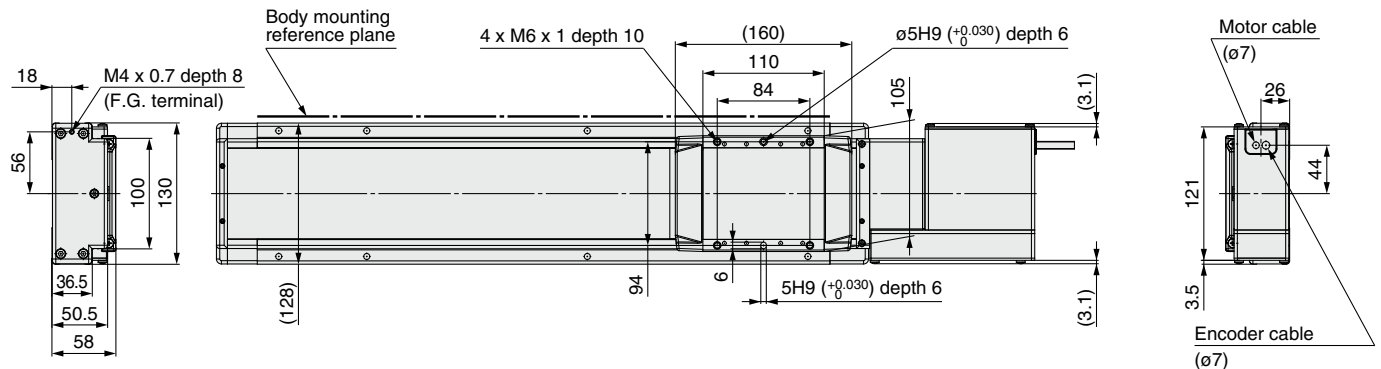

*1 This is the distance within which the table can move when it returns to origin. Make sure that workpieces mounted on the table do not interfere with other workpieces or the facilities around the table.

*2 The Z-phase first detecting position from the stroke end of the motor side

* The auto switch magnet is located in the table center.

Model	L	A	B	n	C	D	E
LEJB40V□□-200□-□□□□	542	206	260	6	1	200	80
LEJB40V□□-300□-□□□□	642	306	360	6	1	200	180
LEJB40V□□-400□-□□□□	742	406	460	8	2	400	80
LEJB40V□□-500□-□□□□	842	506	560	8	2	400	180
LEJB40V□□-600□-□□□□	942	606	660	10	3	600	80
LEJB40V□□-700□-□□□□	1042	706	760	10	3	600	180
LEJB40V□□-800□-□□□□	1142	806	860	12	4	800	80
LEJB40V□□-900□-□□□□	1242	906	960	12	4	800	180
LEJB40V□□-1000□-□□□□	1342	1006	1060	14	5	1000	80
LEJB40V□□-1200□-□□□□	1542	1206	1260	16	6	1200	80
LEJB40V□□-1500□-□□□□	1842	1506	1560	18	7	1400	180
LEJB40V□□-2000□-□□□□	2342	2006	2060	24	10	2000	80

LEJB Series

AC Servo Motor

Dimensions: Belt Drive

LEJB63

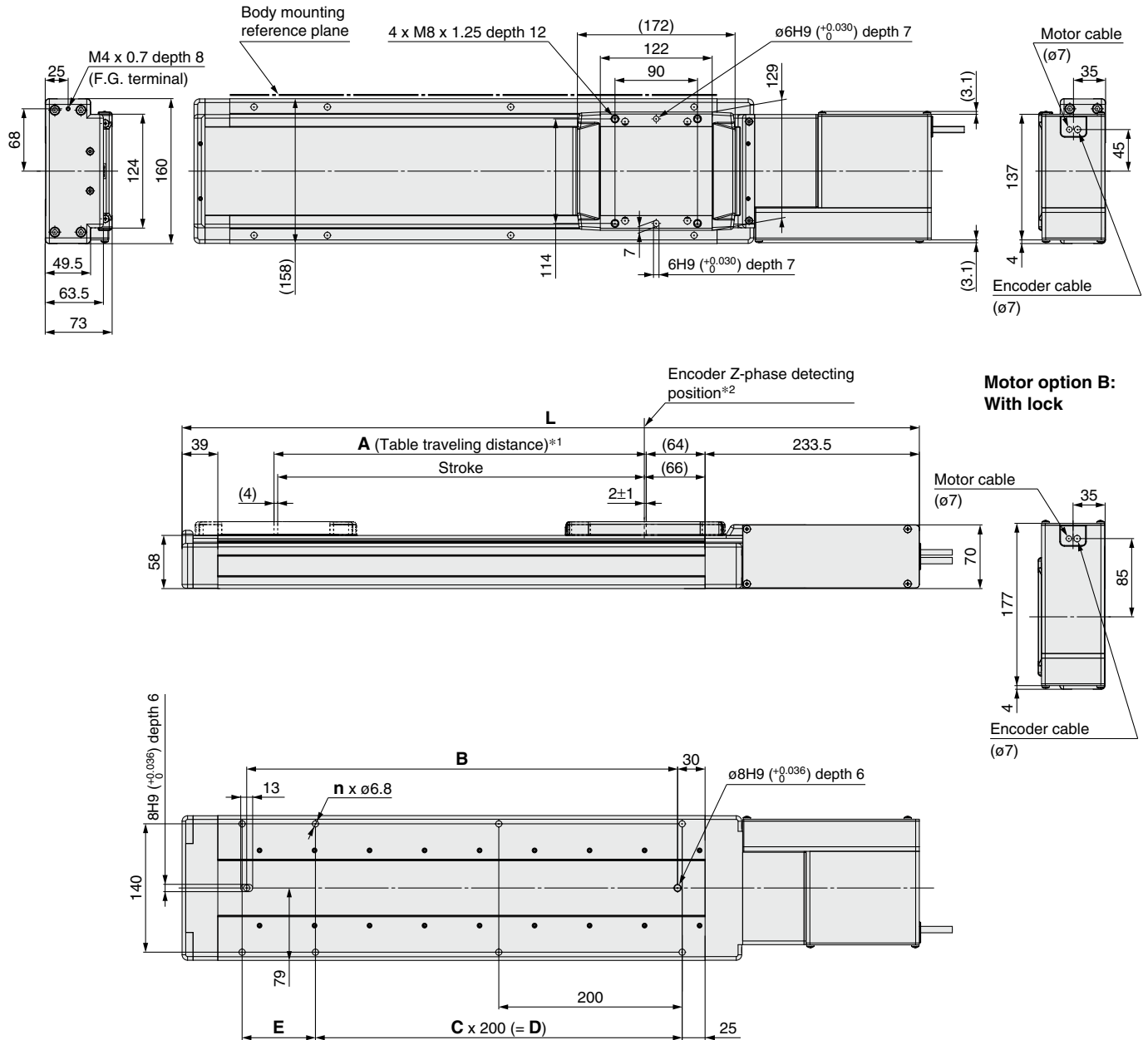

*1 This is the distance within which the table can move when it returns to origin. Make sure that workpieces mounted on the table do not interfere with other workpieces or the facilities around the table.
 *2 The Z-phase first detecting position from the stroke end of the motor side
 * The auto switch magnet is located in the table center.

Model	L	A	B	n	C	D	E	[mm]
LEJB63V□□-300□-□□□□	704	306	370	6	1	200	180	
LEJB63V□□-400□-□□□□	804	406	470	8	2	400	80	
LEJB63V□□-500□-□□□□	904	506	570	8	2	400	180	
LEJB63V□□-600□-□□□□	1004	606	670	10	3	600	80	
LEJB63V□□-700□-□□□□	1104	706	770	10	3	600	180	
LEJB63V□□-800□-□□□□	1204	806	870	12	4	800	80	
LEJB63V□□-900□-□□□□	1304	906	970	12	4	800	180	
LEJB63V□□-1000□-□□□□	1404	1006	1070	14	5	1000	80	
LEJB63V□□-1200□-□□□□	1604	1206	1270	16	6	1200	80	
LEJB63V□□-1500□-□□□□	1904	1506	1570	18	7	1400	180	
LEJB63V□□-2000□-□□□□	2404	2006	2070	24	10	2000	80	
LEJB63V□□-3000□-□□□□	3404	3006	3070	34	15	3000	80	

LEJ Series Auto Switch Mounting

Auto Switch Mounting Position

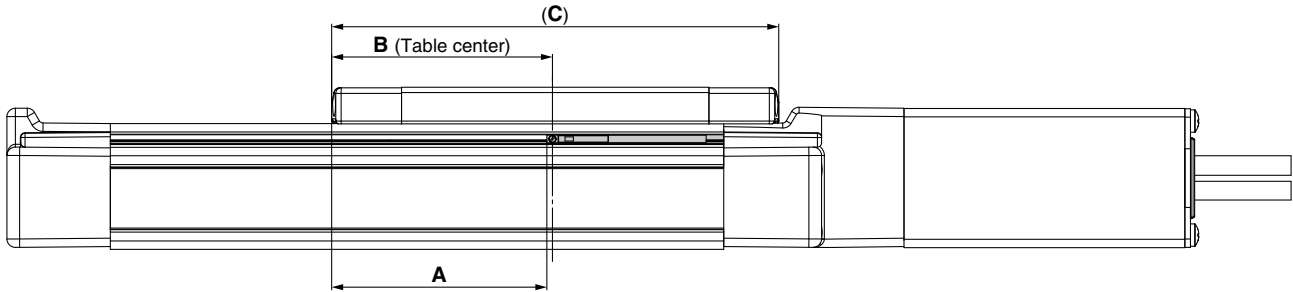

Model	Size	A	B	C	Operating range
LEJS40	40	77	80	160	5.5
LEJB40					5.0
LEJS63	63	83	86	172	7.0
LEJB63					6.5

* The operating range is a guideline including hysteresis, not meant to be guaranteed. There may be large variations (as much as $\pm 30\%$) depending on the ambient environment.

Auto Switch Mounting (Sizes 40 and 63)

When mounting the auto switches, they should be inserted into the actuator's auto switches mounting groove from the direction shown in the drawing on the below. Once in the mounting position, use a flat head watchmaker's screwdriver to tighten the included auto switch mounting screw.

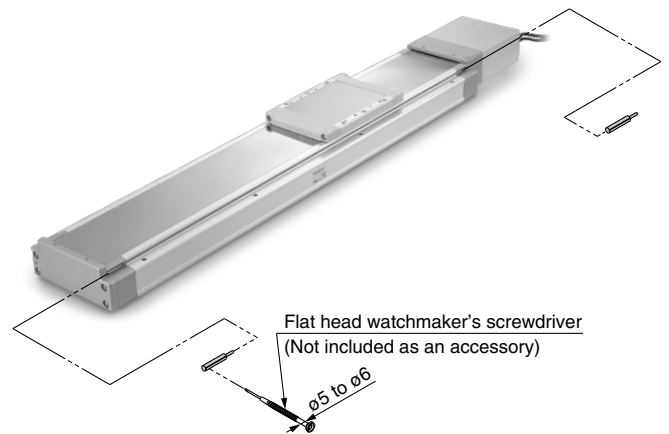

Auto Switch Mounting Screw Tightening Torque [N·m]

Auto switch model	Tightening torque
D-M9□(V) D-M9□W(V) D-M9□E	0.10 to 0.15

* When tightening the auto switch mounting screw (included with the auto switch), use a watchmaker's screwdriver with a handle diameter of about 5 to 6 mm.

Auto Switch Mounting (Size 100)

When mounting an auto switch, first, hold a switch spacer between your fingers and press it into the slot. When doing this, confirm that it is set in the correct mounting orientation, or reinsert it if necessary. Next, insert the auto switch into the slot and slide it until it is positioned under the switch spacer.

After confirming the mounting position, use a flat head watchmaker's screwdriver to tighten the included auto switch mounting screw.

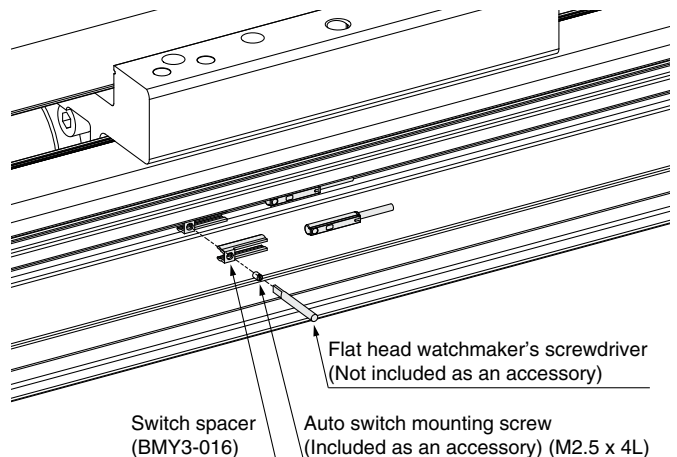

Auto Switch Mounting Screw Tightening Torque [N·m]

Auto switch model	Tightening torque
D-M9□(V) D-M9□W(V)	0.10 to 0.15

Solid State Auto Switch Direct Mounting Type D-M9N(V)/D-M9P(V)/D-M9B(V)



Refer to the SMC website for details on products that are compliant with international standards.

Auto Switch Specifications

PLC: Programmable Logic Controller

D-M9□, D-M9□V (With indicator light)						
Auto switch model	D-M9N	D-M9NV	D-M9P	D-M9PV	D-M9B	D-M9BV
Electrical entry direction	In-line	Perpendicular	In-line	Perpendicular	In-line	Perpendicular
Wiring type	3-wire				2-wire	
Output type	NPN		PNP		—	
Applicable load	IC circuit, Relay, PLC				24 VDC relay, PLC	
Power supply voltage	5, 12, 24 VDC (4.5 to 28 V)				—	
Current consumption	10 mA or less				—	
Load voltage	28 VDC or less		—		24 VDC (10 to 28 VDC)	
Load current	40 mA or less				2.5 to 40 mA	
Internal voltage drop	0.8 V or less at 10 mA (2 V or less at 40 mA)				4 V or less	
Leakage current	100 μA or less at 24 VDC				0.8 mA or less	
Indicator light	Red LED illuminates when turned ON.					
Standard	CE/UKCA marking					

Grommet

- 2-wire load current is reduced (2.5 to 40 mA).
- Using flexible cable as standard spec.



Oilproof Flexible Heavy-duty Lead Wire Specifications

Auto switch model		D-M9N(V)	D-M9P(V)	D-M9B(V)
Sheath	Outside diameter [mm]	ø2.6		
Insulator	Number of cores	3 cores (Brown/Blue/Black)		2 cores (Brown/Blue)
	Outside diameter [mm]	ø0.88		
Conductor	Effective area [mm ²]	0.15		
	Strand diameter [mm]	ø0.05		
Min. bending radius [mm] (Reference values)		17		

- * Refer to page 1363 for solid state auto switch common specifications.
- * Refer to page 1363 for lead wire lengths.

Caution

Precautions

Fix the auto switch with the existing screw installed on the auto switch body. The auto switch may be damaged if a screw other than the one supplied is used.

Weight

[g]

Auto switch model		D-M9N(V)	D-M9P(V)	D-M9B(V)
Lead wire length	0.5 m (Nil)	8	7	7
	1 m (M)	14	13	13
	3 m (L)	41	38	38
	5 m (Z)	68	63	63

Dimensions

[mm]

D-M9□

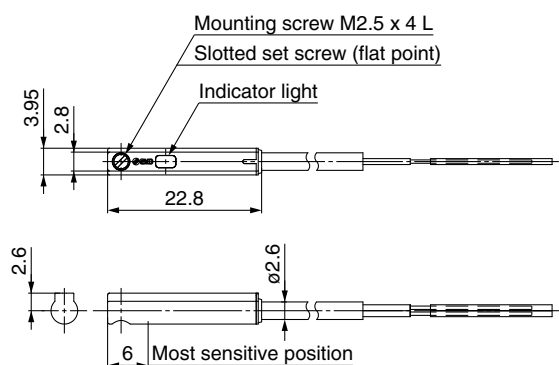

D-M9□V

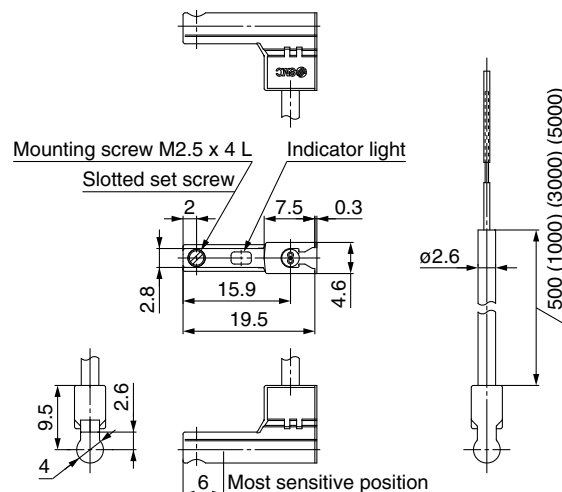

Normally Closed Solid State Auto Switch Direct Mounting Type D-M9NE(V)/D-M9PE(V)/D-M9BE(V)



Refer to the SMC website for details on products that are compliant with international standards.

Auto Switch Specifications

PLC: Programmable Logic Controller

D-M9□E, D-M9□EV (With indicator light)						
Auto switch model	D-M9NE	D-M9NEV	D-M9PE	D-M9PEV	D-M9BE	D-M9BEV
Electrical entry direction	In-line	Perpendicular	In-line	Perpendicular	In-line	Perpendicular
Wiring type	3-wire				2-wire	
Output type	NPN		PNP		—	
Applicable load	IC circuit, Relay, PLC				24 VDC relay, PLC	
Power supply voltage	5, 12, 24 VDC (4.5 to 28 V)				—	
Current consumption	10 mA or less				—	
Load voltage	28 VDC or less		—		24 VDC (10 to 28 VDC)	
Load current	40 mA or less				2.5 to 40 mA	
Internal voltage drop	0.8 V or less at 10 mA (2 V or less at 40 mA)				4 V or less	
Leakage current	100 μA or less at 24 VDC				0.8 mA or less	
Indicator light	Red LED illuminates when turned ON.					
Standard	CE/UKCA marking					

Grommet

- Output signal turns on when no magnetic force is detected.
- Can be used for the actuator adopted by the solid state auto switch D-M9 series (excluding special order products)



Oilproof Flexible Heavy-duty Lead Wire Specifications

Auto switch model		D-M9NE(V)	D-M9PE(V)	D-M9BE(V)
Sheath	Outside diameter [mm]	ø2.6		
Insulator	Number of cores	3 cores (Brown/Blue/Black)		2 cores (Brown/Blue)
	Outside diameter [mm]	ø0.88		
Conductor	Effective area [mm ²]	0.15		
	Strand diameter [mm]	ø0.05		
Min. bending radius [mm] (Reference values)		17		

- * Refer to page 1363 for solid state auto switch common specifications.
- * Refer to page 1363 for lead wire lengths.

Caution

Precautions

Fix the auto switch with the existing screw installed on the auto switch body. The auto switch may be damaged if a screw other than the one supplied is used.

Weight

[g]

Auto switch model		D-M9NE(V)	D-M9PE(V)	D-M9BE(V)
Lead wire length	0.5 m (Nil)	8	7	7
	1 m (M)*1	14	13	13
	3 m (L)	41	38	38
	5 m (Z)*1	68	63	63

*1 The 1 m and 5 m options are produced upon receipt of order.

Dimensions

[mm]

D-M9□E

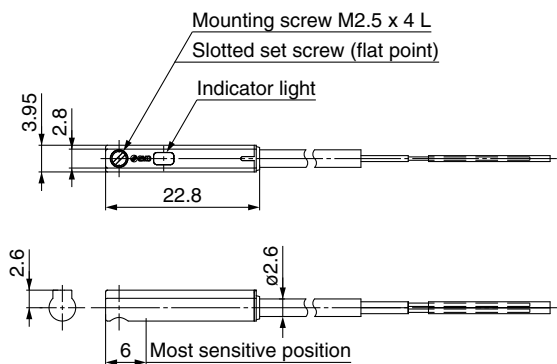

D-M9□EV

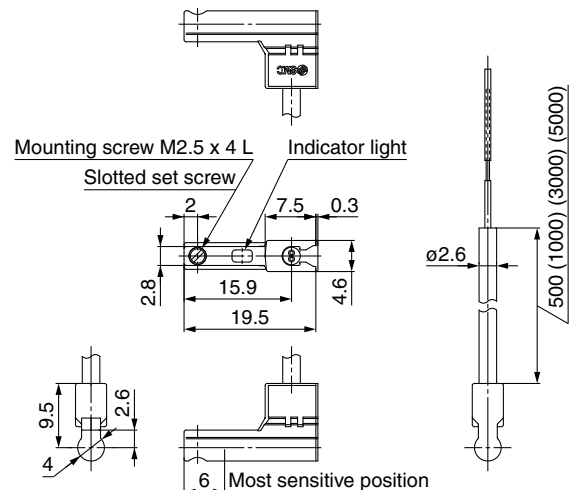

2-Color Indicator Solid State Auto Switch Direct Mounting Type D-M9NW(V)/D-M9PW(V)/D-M9BW(V)



Refer to the SMC website for details on products that are compliant with international standards.

Auto Switch Specifications

PLC: Programmable Logic Controller

D-M9□W, D-M9□WV (With indicator light)						
Auto switch model	D-M9NW	D-M9NWV	D-M9PW	D-M9PWV	D-M9BW	D-M9BWV
Electrical entry direction	In-line	Perpendicular	In-line	Perpendicular	In-line	Perpendicular
Wiring type	3-wire				2-wire	
Output type	NPN		PNP		—	
Applicable load	IC circuit, Relay, PLC				24 VDC relay, PLC	
Power supply voltage	5, 12, 24 VDC (4.5 to 28 V)				—	
Current consumption	10 mA or less				—	
Load voltage	28 VDC or less		—		24 VDC (10 to 28 VDC)	
Load current	40 mA or less				2.5 to 40 mA	
Internal voltage drop	0.8 V or less at 10 mA (2 V or less at 40 mA)				4 V or less	
Leakage current	100 μA or less at 24 VDC				0.8 mA or less	
Indicator light	Operating range Red LED illuminates. Proper operating range Green LED illuminates.					
Standard	CE/UKCA marking					

Grommet

- 2-wire load current is reduced (2.5 to 40 mA).
- Using flexible cable as standard spec.
- The proper operating range can be determined by the color of the light. (Red → Green ← Red)



Caution

Precautions

Fix the auto switch with the existing screw installed on the auto switch body. The auto switch may be damaged if a screw other than the one supplied is used.

Oilproof Flexible Heavy-duty Lead Wire Specifications

Auto switch model		D-M9NW(V)	D-M9PW(V)	D-M9BW(V)
Sheath	Outside diameter [mm]	ø2.6		
Insulator	Number of cores	3 cores (Brown/Blue/Black)		2 cores (Brown/Blue)
	Outside diameter [mm]	ø0.88		
Conductor	Effective area [mm ²]	0.15		
	Strand diameter [mm]	ø0.05		
Min. bending radius [mm] (Reference values)		17		

- * Refer to page 1363 for solid state auto switch common specifications.
- * Refer to page 1363 for lead wire lengths.

Weight

[g]

Auto switch model		D-M9NW(V)	D-M9PW(V)	D-M9BW(V)
Lead wire length	0.5 m (Nil)	8	7	7
	1 m (M)	14	13	13
	3 m (L)	41	38	38
	5 m (Z)	68	63	63

Dimensions

[mm]

D-M9□W

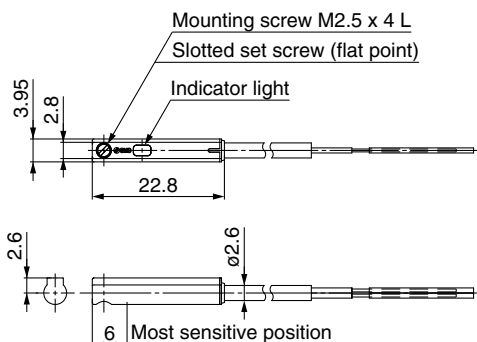

D-M9□WV

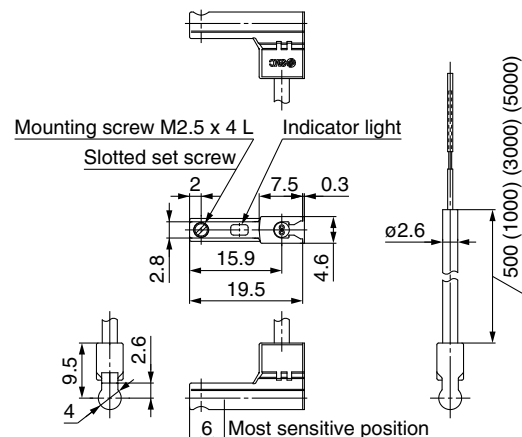



LEJ Series Specific Product Precautions 1

Be sure to read this before handling the products. Refer to page 1351 for safety instructions, pages 1352 to 1357 for electric actuator precautions, and pages 1358 to 1367 for auto switch precautions.

Design

⚠ Caution

- 1. Do not apply a load in excess of the specification limits.**

Select a suitable actuator by work load and allowable moment. If a load in excess of the specification limits is applied to the guide, adverse effects such as the generation of play in the guide, reduced accuracy, or reduced service life of the product may occur.
- 2. Do not use the product in applications where excessive external force or impact force is applied to it.**

The product can be damaged.
The components including the motor are manufactured to precise tolerances. So that even a slight deformation may cause a malfunction or seizure.

Selection

⚠ Warning

- 1. Do not increase the speed in excess of the specification limits.**

Select a suitable actuator by the relationship between the allowable work load and speed, and the allowable speed of each stroke. If the product is used outside of the specification limits, adverse effects such as the generation of noise, reduced accuracy, or reduced service life of the product may occur.
- 2. When the product repeatedly cycles with partial strokes (100 mm or less), lubrication can run out. Operate it at a full stroke at least once a day or every a thousand cycles.**
- 3. When external force is to be applied to the table, it is necessary to add the external force to the work load as the total carried load when selecting a size.**

When a cable duct or flexible moving tube is attached to the actuator, the sliding resistance of the table will increase, which may lead to the malfunction of the product.

Handling

⚠ Caution

- 1. Never allow the table to collide with the stroke end.**

When incorrect instructions are inputted, such as those which cause the product to operate outside of the specification limits or outside of the actual stroke through changes in the controller/driver settings and/or origin position, the table may collide with the stroke end of the actuator. Be sure to check these points before use.
If the table collides with the stroke end of the actuator, the guide, belt, or internal stopper may break. This can result in abnormal operation.



- Handle the actuator with care when it is used in the vertical direction as the workpiece will fall freely from its own weight.
- 2. The actual speed of this actuator is affected by the work load and stroke.**

Check the model selection section of the catalog.
 - 3. Do not apply a load, impact or resistance in addition to the transferred load during return to origin.**
 - 4. Do not dent, scratch, or cause other damage to the body or table mounting surfaces.**

Doing so may cause unevenness in the mounting surface, play in the guide, or an increase in the sliding resistance.
 - 5. Do not apply strong impact or an excessive moment while mounting the product or a workpiece.**

If an external force over the allowable moment is applied, it may cause play in the guide or an increase in the sliding resistance.
 - 6. Keep the flatness of the mounting surface within 0.1 mm/500 mm.**

If a workpiece or base does not sit evenly on the body of the product, play in the guide or an increase in the sliding resistance may occur.
In the case of overhang mounting (including cantilever), use a support plate or support guide to avoid deflection of the actuator body.
 - 7. When mounting the actuator, use all mounting holes.**

If all mounting holes are not used, it influences the specifications, e.g., the amount of displacement of the table increases.
 - 8. Do not allow a workpiece to collide with the table during the positioning operation or within the positioning range.**
 - 9. Do not apply external force to the dust seal band.**

Particularly during the transportation



LEJ Series Specific Product Precautions 2

Be sure to read this before handling the products. Refer to page 1351 for safety instructions, pages 1352 to 1357 for electric actuator precautions, and pages 1358 to 1367 for auto switch precautions.

Handling

⚠ Caution

10. When mounting the product, use screws of adequate length and tighten them with adequate torque.

Tightening the screws with a higher torque than recommended may result in a malfunction, while tightening with a lower torque can result in the displacement of the mounting position or, in extreme conditions, the actuator could become detached from its mounting position.

Body fixed

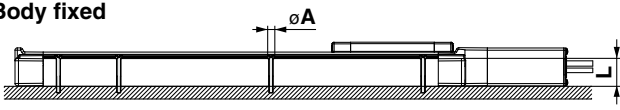

Model	Screw size	Max. tightening torque [N·m]	ϕA [mm]	L [mm]
LEJ□40	M5	3.0	5.5	36.5
LEJ□63	M6	5.2	6.8	49.5

Workpiece fixed

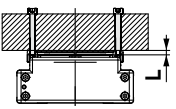

Model	Screw size	Max. tightening torque [N·m]	L (Max. screw-in depth) [mm]
LEJ□40	M6 x 1	5.2	10
LEJ□63	M8 x 1.25	12.5	12

To prevent the workpiece retaining screws from touching the body, use screws that are 0.5 mm or shorter than the maximum screw-in depth. If long screws are used, they may touch the body and cause a malfunction.

11. Do not operate by fixing the table and moving the actuator body.
12. The belt drive actuator cannot be used for vertical applications.
13. Vibration may occur during operation, this could be caused by the operating conditions.
If it occurs, adjust response value of auto tuning of driver to be lower.
During the first auto tuning noise may occur, the noise will stop when the tuning is complete.
14. When mounting the actuator using the body mounting reference plane, use a pin. Set the height of the pin to be 5 mm or more because of round chamfering. (Recommended height 6 mm)

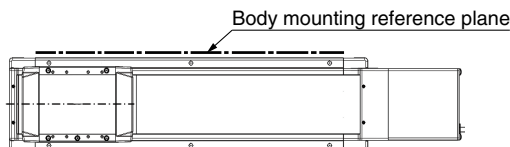

15. When the fluctuations in the load are caused during operation, malfunction, noise, or alarm generation may occur. (In the case of the AC servo motor)

The gain tuning may not be suitable for fluctuating loads. Adjust the gain properly by following the instructions in the driver manual.

Maintenance

⚠ Warning

Maintenance frequency

Perform maintenance according to the table below.

Frequency	Appearance check	Internal check	Belt check
Inspection before daily operation	○	—	—
Inspection every 6 months/1000 km/5 million cycles*1	○	○	○

*1 Select whichever comes first.

• Items for visual appearance check

1. Loose set screws, Abnormal amount of dirt, etc.
2. Check for visible damage, Check of cable joint
3. Vibration, Noise

• Items for internal check

1. Lubricant condition on moving parts
* For lubrication, use lithium grease No. 2.
2. Loose or mechanical play in fixed parts or fixing screws

• Items for belt check

Stop operation immediately and replace the belt when any of the following occur. In addition, ensure your operating environment and conditions satisfy the requirements specified for the product.

a. Tooth shape canvas is worn, out

Canvas fiber becomes fuzzy, Rubber is coming off and the fiber has become whitish, Lines of fibers have become unclear

b. Peeling off or wearing of the side of the belt

Belt corner has become rounded and frayed threads stick out

c. Belt partially cut

Belt is partially cut, Foreign matter caught in the teeth of other parts is causing damage

d. A vertical line on belt teeth is visible

Damage which is made when the belt runs on the flange

e. Rubber back of the belt is softened and sticky

f. Cracks on the back of the belt are visible