

Manifold Controller

Battery-less Absolute (Step Motor 24 VDC)

New



RoHS

Up to 16 axes can be connected

Fanless design (no cooling fan)

No cooling fan = No need to worry about fan replacement

Operating temperature range

0 to 55°C

Communication protocol

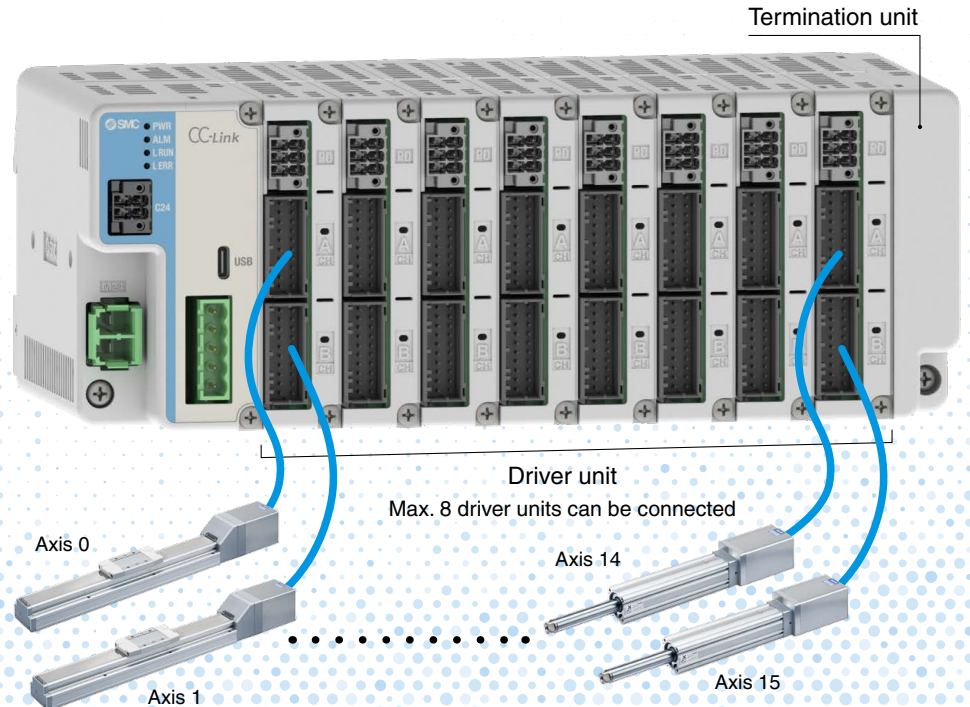

Everything can be attached from the front.

Compact design

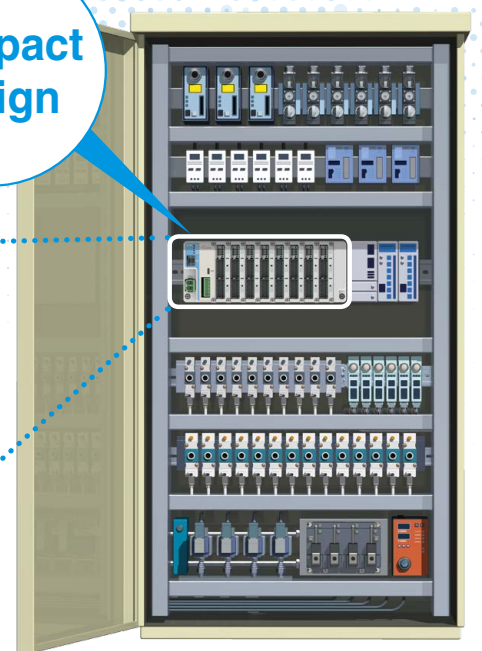
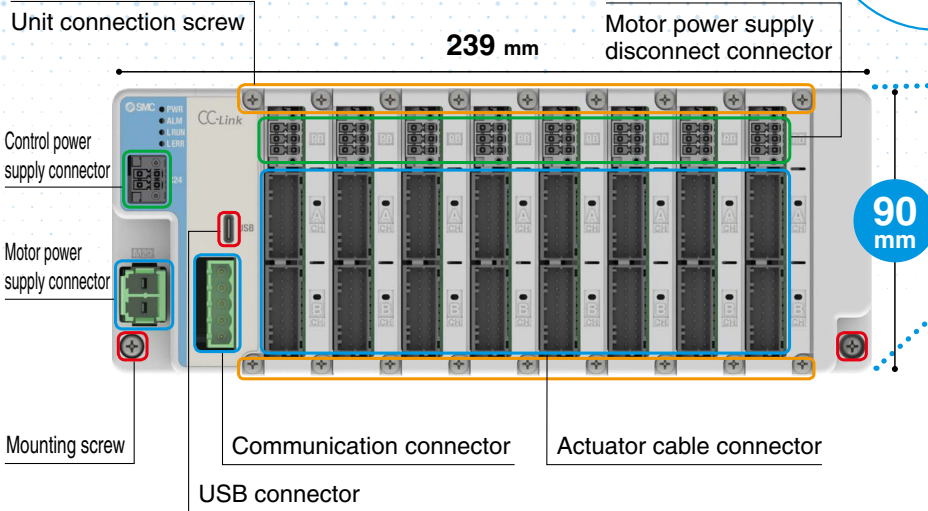

JXD1-M □ Series

Space Saving

Width 66% (471 mm) reduction

Height 47% (80 mm) reduction

Manifold Controller
JXD1-M Series

Height: 47% (80 mm*1) reduction

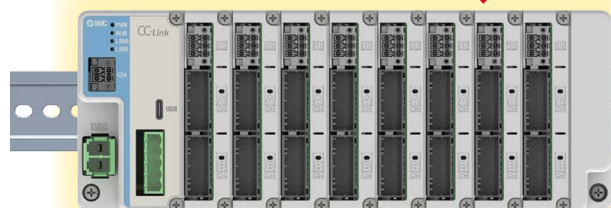

66% (471 mm) reduction

Step Motor Controller

JXC1 Series x **16** controllers

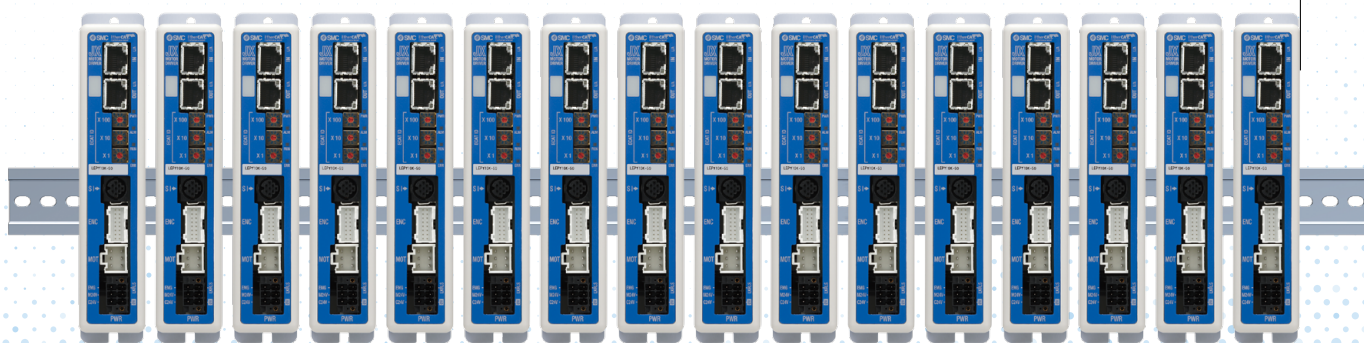

*1 DIN rail mounting

Easy-to-order Driver Units

- No need to input actuator part numbers when ordering
- Ensures the delivery of correctly connected units
- No need to stock (dedicated) controllers

Easy Registration of Connected Actuators

- When the connected actuator is recognized, the initial actuator settings can be recorded in the controller via the setting software.
- The initial settings can be recorded in the controller in the same way via the setting software even when the connected actuator is changed.

Manifold Controller Compatible Electric Actuator

Annual CO₂ emissions:
Max. **38%** reduction

8.7 kg-CO₂e/year (14.1)

* The numerical values vary depending on the operating conditions.

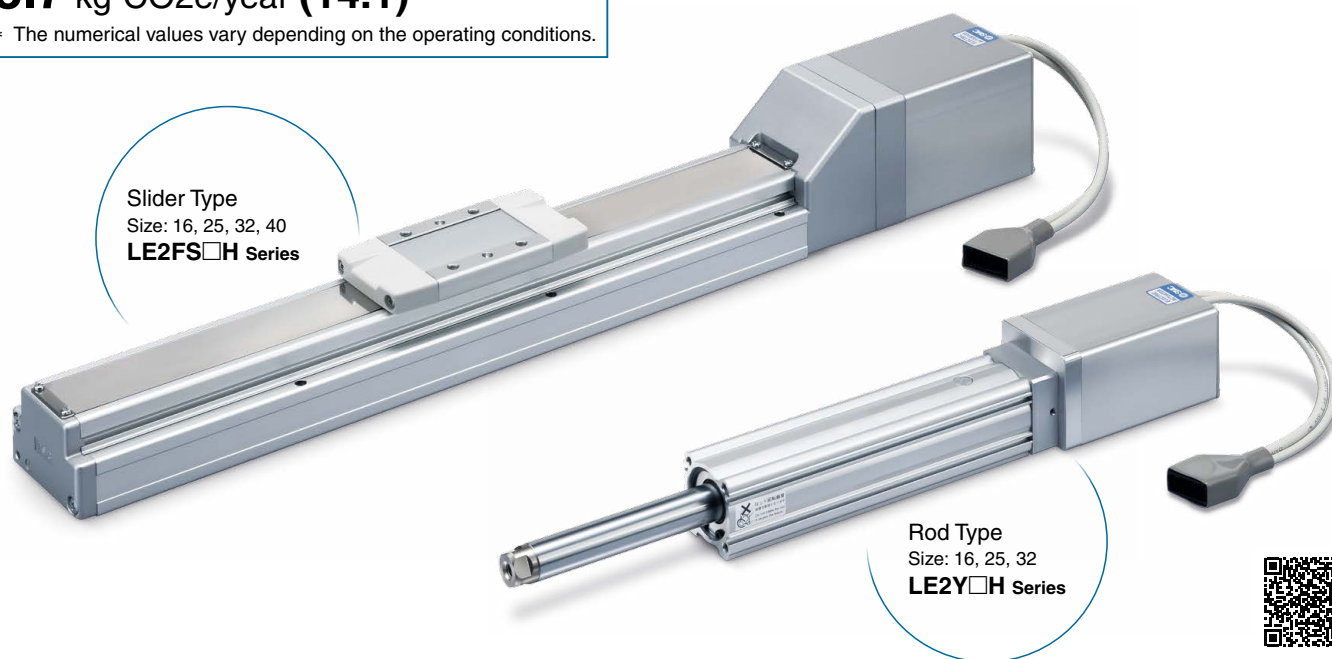

Slider Type
Size: 16, 25, 32, 40
LE2FS□H Series

Rod Type
Size: 16, 25, 32
LE2Y□H Series



More information
can be viewed here.

Type		Slider Type		Rod Type	
Series		LE2FS□H		LE2Y□H	
Actuation type		In-line: Ball screw Parallel: Ball screw + Belt			
Max. speed*1 [mm/s]		1200		900	
Positioning repeatability [mm]		±0.015 (Lead H for size 25/32/40: ±0.02)		±0.02	
Drive motor	Battery-less absolute (Step motor 24 VDC)	●		●	
Operation mode		Positioning operation Pushing operation			
Size	16	●		●	
	25	●		●	
	32	●		●	
	40	●		—	
Max. work load [kg] The values in parentheses are for when mounted vertically	16	18 (12)		40 (10)	
	25	40 (15)		70 (30)	
	32	68 (20)		100 (46)	
	40	80 (40)		—	
Max. pushing force [N]	16	154		154	
	25	511		511	
	32	796		796	
	40	637		—	
Max. stroke [mm]		1200		500	
Auto switch mounting		●		●	

*1 The numerical values vary depending on the actuator type, work load, speed, and specifications.
Please contact SMC for further details.

System Construction

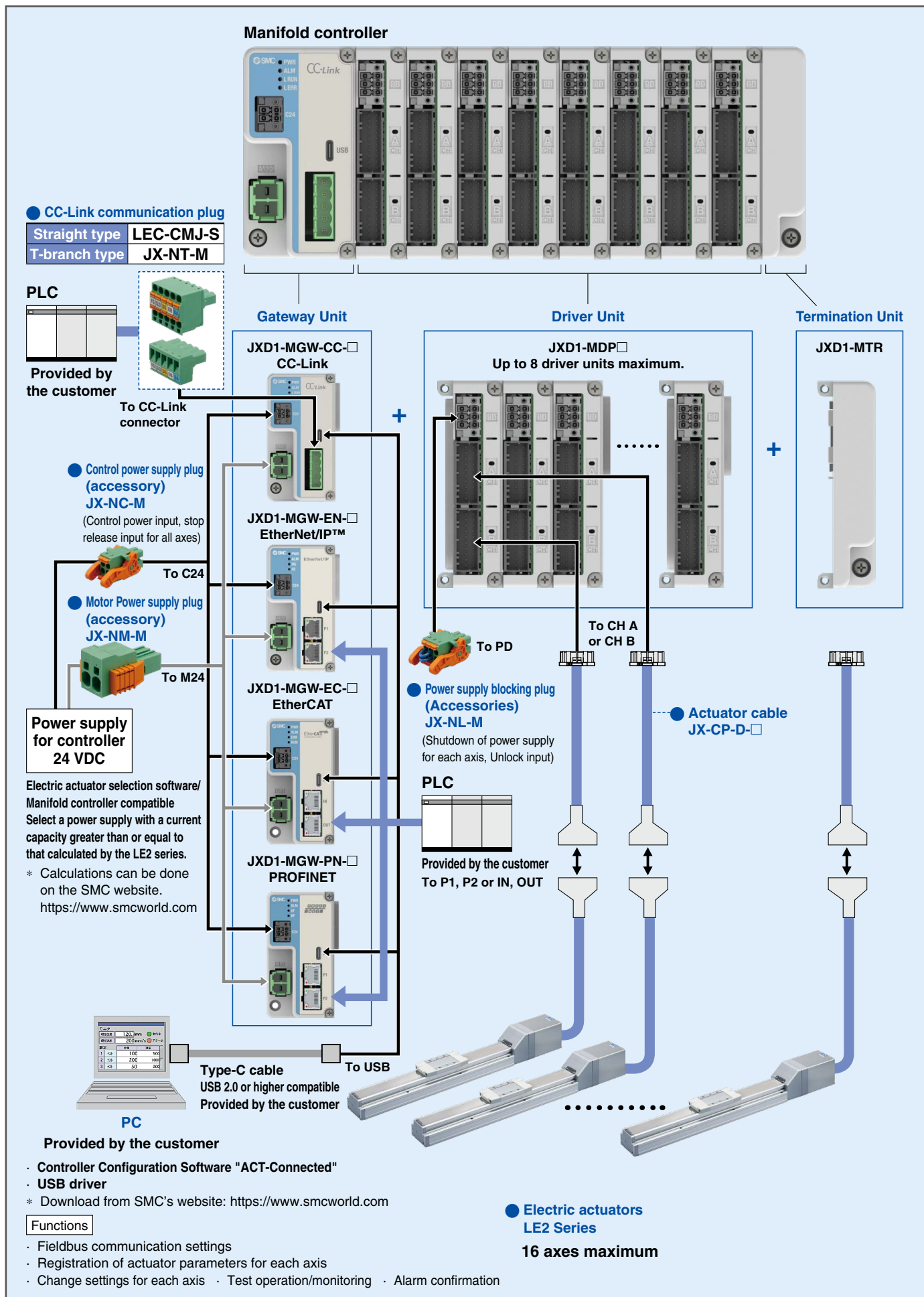

Manifold Controller

JXD1-M□ Series

How to Order

Gateway Unit



JXD1 - MGW - **CC** - **8** **U** **S** **R**

• **Communication protocol**

Symbol	Description
CC	CC-Link
EN	EtherNet/IP™
EC	EtherCAT
PN	PROFINET

• **Mounting**

Symbol	Description
7	Direct mounting bracket included
8	DIN rail mounting bracket included

• **Communication port for setting**

Symbol	Description
U	USB port

• **Option 2**

Symbol	Description
Nil	Terminal unit not included
R	Termination unit included

• **Option 1**

Symbol	Description
Nil	Plug for CC-Link not included
S	Straight type communication plug for CC-Link
T	T branch type communication plug for CC-Link

* Leave blank ("Nil") when the gateway unit is not CC-Link compatible.

* Prepare a terminating resistor to suit your application.

Driver Unit



JXD1 - MDP **2**

• **Number of connected axes**

Symbol	Description
1	1 axis
2	2 axis

Termination Unit

JXD1 - MTR



* When selecting a gateway unit, select "R" for option 2 to include it in the package.

JXD1-M Series

Battery-less Absolute (Step Motor 24 VDC)

Specifications

Basic Specifications

Power supply voltage	24 VDC \pm 10%
Current consumption	Determined by unit configuration, actuator type and number of axes connected (refer to the "Electric Actuator Selection Software" on the SMC website)
Number of axes	Max. 16 axes maximum (max. 8 driver units can be connected)
Applicable Encoders	Battery-less absolute
Component unit	Gateway unit, Driver unit (for 1 or 2 axes), Termination Unit
Communication with PC	USB (Type C)/Connected to gateway unit
Stop input	Gateway unit: Stop input for all axes Driver unit: power supply cutoff disconnect for each axis
Protection function	Overcurrent, overspeed, encoder disconnection, overload, temperature abnormality
Predictive maintenance function	Cumulative number of movement instructions, Cumulative distance travelled, Check life of electrolytic capacitors
Operating temperature range [°C]	0 to 55 (No freezing)
Operating humidity range [%RH]	35 to 85 or less (No condensation)
Insulation resistance [M Ω]	Between all external terminals and the case: 50 (500 VDC)
Protection class	Equivalent to IP20
Cooling system	Air-cooled, no fan
Installation method	DIN rail (35 mm), Direct mounting

Gateway Unit Specifications

Model		JXD1-MGW-CC-□	JXD1-MGW-EN-□	JXD1-MGW-EC-□	JXD1-MGW-PN-□	
Control power current consumption (gateway unit only) [mA]*1		350 or less				
Communication	Applicable system	Protocol	CC-Link	EtherNet/IP™*4	EtherCAT*4	PROFINET*4
		Version*2	Ver 1.10 Ver 2.00	CT19	Conformance Test Record V.1.2.9	Ver.2.44
	Communication speed	156 kbps, 625 kbps, 2.5 Mbps, 5 Mbps, 10 Mbps	10/100 Mbps	100 Mbps		
	Configuration file*3	CSP + file	EDS file	ESI file	GSDML file	
	Occupied area	2 stations, 4 stations	Input/Output : 18 bytes to 272 bytes			
Insulation resistance	Not included					
LED indicator	PWR, ALM, L RUN, L ERR	PWR, ALM, MS, NS	PWR, ALM, RUN, ERR	PWR, ALM, SF, BF		
Accessory	Control power supply plug x 1, Motor power supply plug x 1					
Weight [g]	250 or less					

*1 Lock current consumption is added to the motor power supply when a locking actuator is used.

*2 Please note that versions are subject to change.

*3 The files can be downloaded from the SMC website.

*4 Use a shielded communication cable with CAT5 or higher for the EtherNet/IP™, EtherCAT, and PROFINET.

■ Trademark

EtherNet/IP® is a registered trademark of ODVA, Inc.

EtherCAT® is registered trademark and patented technology, licensed by Beckhoff Automation GmbH, Germany.

Driver Unit

Model	JXD1-MDP1	JXD1-MDP2
Connecting actuator	LE2□ Series	
Actuator cable length [m]	20 or less	
Control power consumption current (driver unit only) [mA]	200 or less	
Number of axes	1 axis	2 axis
LED indicator	Indicated by the servo motor is ON (green), ALARM (red) * 2-colour LED for each axis	
Accessory	Power supply blocking plug x 1	
Weight [g]	180 or less	200 or less

Termination Unit

Model	JXD1-MTR
Weight [g]	100 or less

Dimensions

Gateway Unit: JXD1-MGW-□

<Direct mounting>

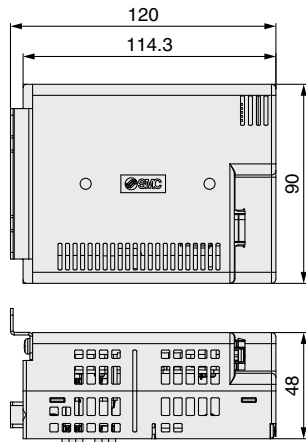

JXD1-MGW-CC-□
(CC-Link)

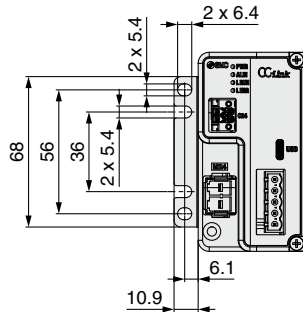

JXD1-MGW-EN-□
(EtherNet/IP™)

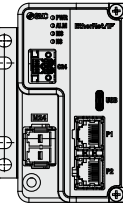

JXD1-MGW-EC-□
(EtherCAT)

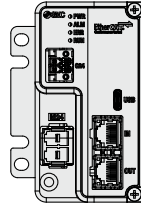

JXD1-MGW-PN-□
(PROFINET)

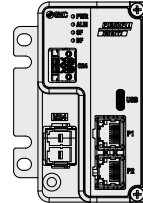

<DIN rail mounting>

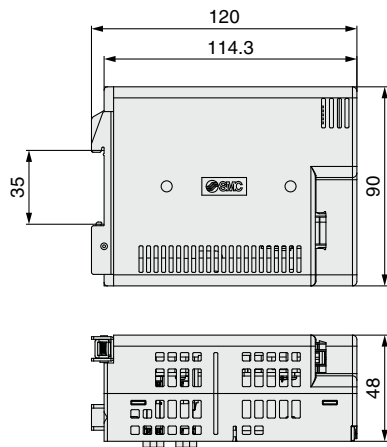

JXD1-MGW-CC-□
(CC-Link)

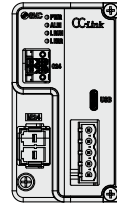

JXD1-MGW-EN-□
(EtherNet/IP™)

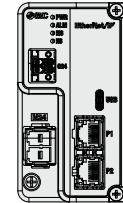

JXD1-MGW-EC-□
(EtherCAT)

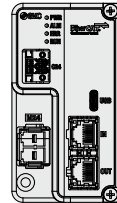

JXD1-MGW-PN-□
(PROFINET)

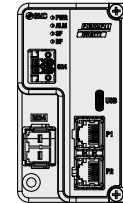

Driver Unit: JXD1-MDP1/JXD1-MDP2

JXD1-MDP2

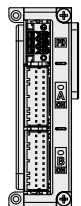

JXD1-MDP1

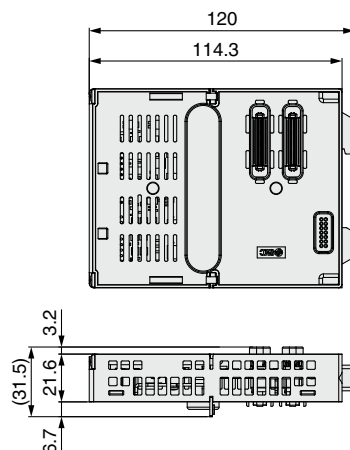
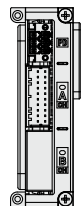

JXD1-M Series

Battery-less Absolute (Step Motor 24 VDC)

Dimensions

Termination Unit: JXD1-MTR

<Direct mounting>

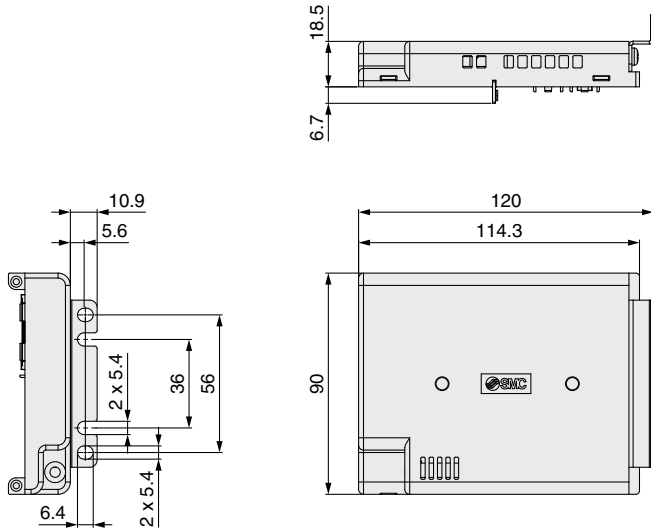

<DIN rail mounting>

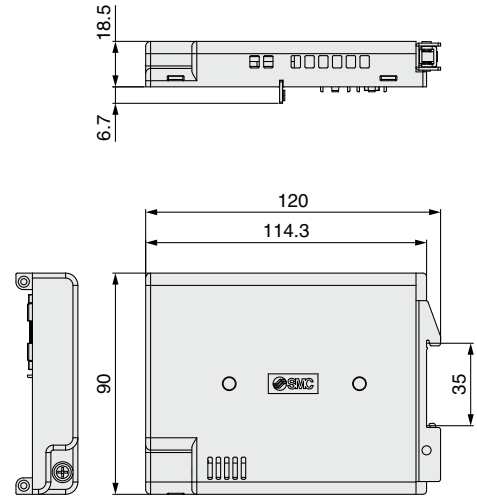

Dimensions for manifolds

<Direct mounting>

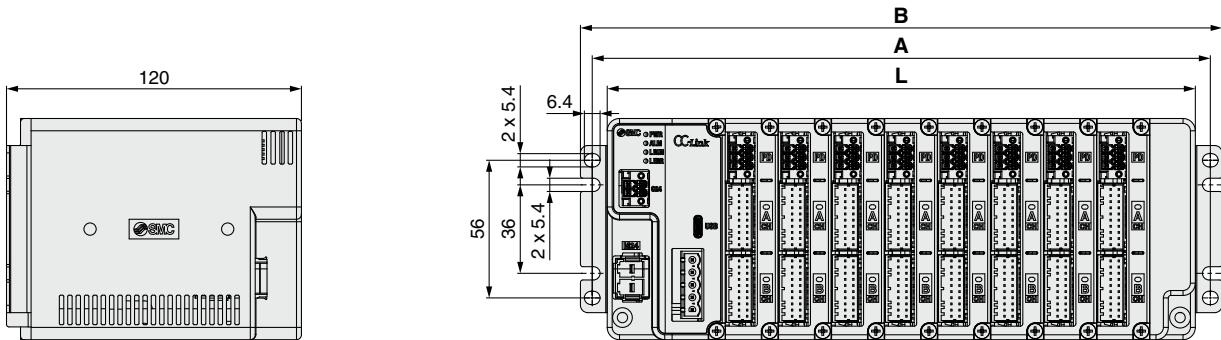

<DIN rail mounting>

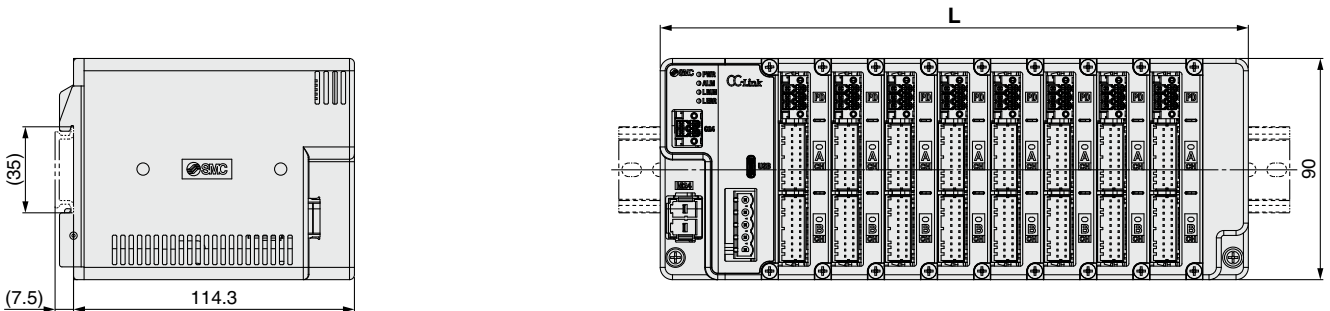

Number of driver units	1	2	3	4	5	6	7	8
A	100.3	121.9	143.5	165.1	186.5	208.3	229.9	251.5
B	109.9	131.5	153.1	174.7	196.3	217.9	239.5	261.1
L	88.1	109.7	131.3	152.9	174.5	196.1	217.7	239.3

[mm]

Options

■ CC-Link communication plug

Straight type
LEC-CMJ-S



T-branch type
JX-NT-M



Communication plug
connector for CC-Link

Terminal name	Details
DA	CC-Link communication line A
DB	CC-Link communication line B
DG	CC-Link ground line
SLD	CC-Link shield
FG	Frame ground

<Applicable cable size>
AWG24 to 12 (0.2 to 2.5 mm²)

* Prepare a terminating resistor to suit your application.

■ Motor power supply plug

JX-NM-M

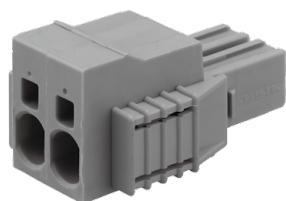

Terminal no.	Terminal name	Function	Details
1	0V	Common supply (-)	The M24V terminal, C24V, EMG terminal, and LK RLS terminal are common (-).
2	M24V	Motor power supply (+)	Motor power supply (+) of the controller

<Applicable cable size>
AWG22-8, cover diameter 6 mm or less

* Select a wire size with a diameter that allows for the control power supply and the power supply to carry more than the total current.

■ Control power supply plug

JX-NC-M

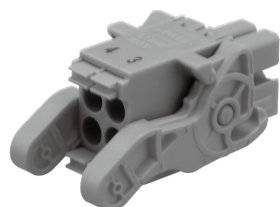

Terminal no.	Terminal name	Function	Details
1	NC	Not used	—
2	C24V	Control power supply (+)	Control power supply (+) of the controller
3	FG	Frame ground	Grounding terminal.
4	EMG	Release lock (+)	Connection terminal for external stop circuit for all-axes. * When 24 VDC is input, stop of all axes is released. * When open, stop all axes (deceleration)

<Applicable cable size>
AWG20 (0.5 mm²), cover diameter 2.5 mm or less

■ Power supply blocking plug

JX-NL-M

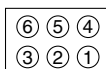
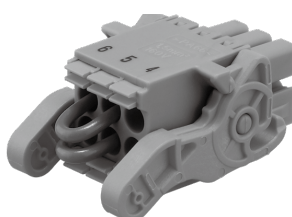

Terminal no.	Terminal name	Function	Details
1	LKRLS1	CH A Unlocking (+)	Connection terminal of lock release signal for CH A.
2	M24VIN1	Power supply input of CH A	Input terminal of Motor power supply for CH A. * When open, Turns off the motor power supply for CH A
3	M24VOUT 1	Power supply output of CH A	Output terminal of Motor power supply for CH A. * Connect to motor power input terminal for CH A and supply power to CH A.
4	LKRLS2	CH B Unlocking (+)	Connection terminal of lock release signal for CH B.
5	M24VIN2	Power supply input of CH B	Input terminal of Motor power supply for CH B. * When open, Turns off the motor power supply for CH B
6	M24VOUT 2	Power supply output of CH B	Output terminal of Motor power supply for CH B. * Connect to motor power input terminal for CH B and supply power to CH B.

<Applicable cable size>
AWG22-20, cover diameter 2.5 mm or less

JXD1-M Series

Battery-less Absolute (Step Motor 24 VDC)

Options

Direct mounting bracket

JX-SC-M

- * There are 2 direct mounting brackets per set.
- * Attach the direct mounting brackets to the rear of the Gateway unit and the Termination unit so that the controller can be mounted directly to a panel or similar using screws.
- * For the dimensions when the brackets are connected, refer to the "Dimensions for manifolds" section on the "Dimensions" page.

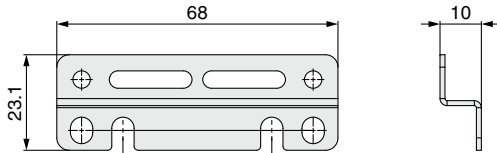

Accessory

Description	Quantity
Tapping screw (4 x 10)	4

DIN rail mounting bracket

JX-DR-M

- * There are 2 DIN rail mounting brackets per set.
- * For the dimensions when the brackets are connected, refer to the "Dimensions for manifolds" section on the "Dimensions" page.

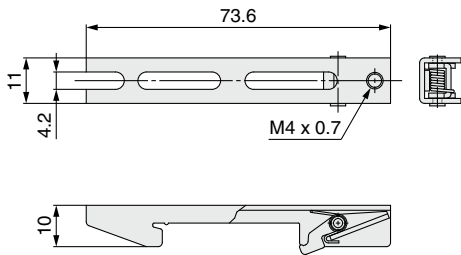

Accessory

Description	Quantity
Tapping screw (4 x 10)	4
Round head screw (M4 x 95)	2

Actuator cable

JX-CP-D-

Cable length

Symbol	L	D
1	1.5 m	8 mm
3	3 m	
5	5 m	
8	8 m	
A	10 m	
B	15 m ^{*1}	11 mm
C	20 m ^{*1}	

*1 Produced upon receipt of order

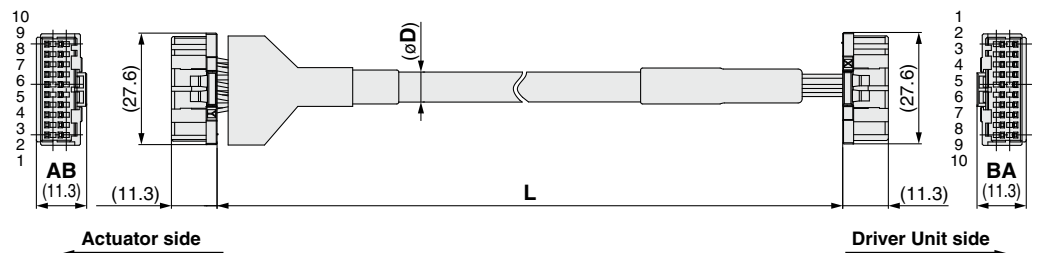

DIN rail

AXT100-DR-

- * For , enter a number from the "No." line in the table below. Refer to the "Dimensions" page for mounting dimensions.

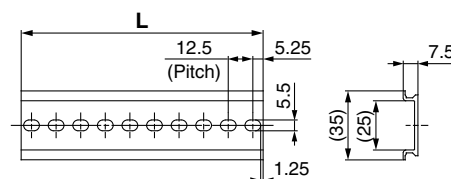



No.	1	2	3	4	5	6	7	8	9	10	11	12	13	14	15	16	17	18	19	20
L	23	35.5	48	60.5	73	85.5	98	110.5	123	135.5	148	160.5	173	185.5	198	210.5	223	235.5	248	260.5
No.	21	22	23	24	25	26	27	28	29	30	31	32	33	34	35	36	37	38	39	40
L	273	285.5	298	310.5	323	335.5	348	360.5	373	385.5	398	410.5	423	435.5	448	460.5	473	485.5	498	510.5

Safety Instructions

These safety instructions are intended to prevent hazardous situations and/or equipment damage. These instructions indicate the level of potential hazard with the labels of “**Caution**,” “**Warning**” or “**Danger**.” They are all important notes for safety and must be followed in addition to International Standards (ISO/IEC)*1), and other safety regulations.

 **Danger** : **Danger** indicates a hazard with a high level of risk which, if not avoided, will result in death or serious injury.

 **Warning**: **Warning** indicates a hazard with a medium level of risk which, if not avoided, could result in death or serious injury.

 **Caution**: **Caution** indicates a hazard with a low level of risk which, if not avoided, could result in minor or moderate injury.

*1) ISO 4414: Pneumatic fluid power - General rules and safety requirements for systems and their components
ISO 4413: Hydraulic fluid power - General rules and safety requirements for systems and their components
IEC 60204-1: Safety of machinery - Electrical equipment of machines - Part 1: General requirements
ISO 10218-1: Robots and robotic devices - Safety requirements for industrial robots - Part 1: Robots etc.

Warning

1. The compatibility of the product is the responsibility of the person who designs the equipment or decides its specifications.

Since the product specified here is used under various operating conditions, its compatibility with specific equipment must be decided by the person who designs the equipment or decides its specifications based on necessary analysis and test results. The expected performance and safety assurance of the equipment will be the responsibility of the person who has determined its compatibility with the product. This person should also continuously review all specifications of the product referring to its latest catalog information, with a view to giving due consideration to any possibility of equipment failure when configuring the equipment.

2. Only personnel with appropriate training should operate machinery and equipment.

The product specified here may become unsafe if handled incorrectly. The assembly, operation and maintenance of machines or equipment including our products must be performed by an operator who is appropriately trained and experienced.

3. Do not service or attempt to remove product and machinery/equipment until safety is confirmed.

1. The inspection and maintenance of machinery/equipment should only be performed after measures to prevent falling or runaway of the driven objects have been confirmed.
2. When the product is to be removed, confirm that the safety measures as mentioned above are implemented and the power from any appropriate source is cut, and read and understand the specific product precautions of all relevant products carefully.
3. Before machinery/equipment is restarted, take measures to prevent unexpected operation and malfunction.

4. Our products cannot be used beyond their specifications. Our products are not developed, designed, and manufactured to be used under the following conditions or environments. Use under such conditions or environments is not covered.

1. Conditions and environments outside of the given specifications, or use outdoors or in a place exposed to direct sunlight.
2. Use for nuclear power, railways, aviation, space equipment, ships, vehicles, military application, equipment affecting human life, body, and property, fuel equipment, entertainment equipment, emergency shut-off circuits, press clutches, brake circuits, safety equipment, etc., and use for applications that do not conform to standard specifications such as catalogs and operation manuals.
3. Use for interlock circuits, except for use with double interlock such as installing a mechanical protection function in case of failure. Please periodically inspect the product to confirm that the product is operating properly.

Caution

We develop, design, and manufacture our products to be used for automatic control equipment, and provide them for peaceful use in manufacturing industries.

Use in non-manufacturing industries is not covered.

Products we manufacture and sell cannot be used for the purpose of transactions or certification specified in the Measurement Act.

The new Measurement Act prohibits use of any unit other than SI units in Japan.

Limited warranty and Disclaimer/ Compliance Requirements

The product used is subject to the following “Limited warranty and Disclaimer” and “Compliance Requirements”.

Read and accept them before using the product.

Limited warranty and Disclaimer

1. The warranty period of the product is 1 year in service or 1.5 years after the product is delivered, whichever is first.*2)
Also, the product may have specified durability, running distance or replacement parts. Please consult your nearest sales branch.
2. For any failure or damage reported within the warranty period which is clearly our responsibility, a replacement product or necessary parts will be provided.
This limited warranty applies only to our product independently, and not to any other damage incurred due to the failure of the product.
3. Prior to using SMC products, please read and understand the warranty terms and disclaimers noted in the specified catalog for the particular products.

*2) **Vacuum pads are excluded from this 1 year warranty.**

A vacuum pad is a consumable part, so it is warranted for a year after it is delivered. Also, even within the warranty period, the wear of a product due to the use of the vacuum pad or failure due to the deterioration of rubber material are not covered by the limited warranty.

Compliance Requirements

1. The use of SMC products with production equipment for the manufacture of weapons of mass destruction (WMD) or any other weapon is strictly prohibited.
2. The exports of SMC products or technology from one country to another are governed by the relevant security laws and regulations of the countries involved in the transaction. Prior to the shipment of a SMC product to another country, assure that all local rules governing that export are known and followed.

Safety Instructions

Be sure to read the “Handling Precautions for SMC Products” (M-E03-3) and “Operation Manual” before use.

SMC Corporation

Akihabara UDX 15F,
4-14-1, Sotokanda, Chiyoda-ku, Tokyo 101-0021, JAPAN
Phone: 03-5207-8249 Fax: 03-5298-5362
<https://www.smcworld.com>
© 2024 SMC Corporation All Rights Reserved

Specifications are subject to change without prior notice and any obligation on the part of the manufacturer.

D-G