

# Air Saving Impact Blow Gun

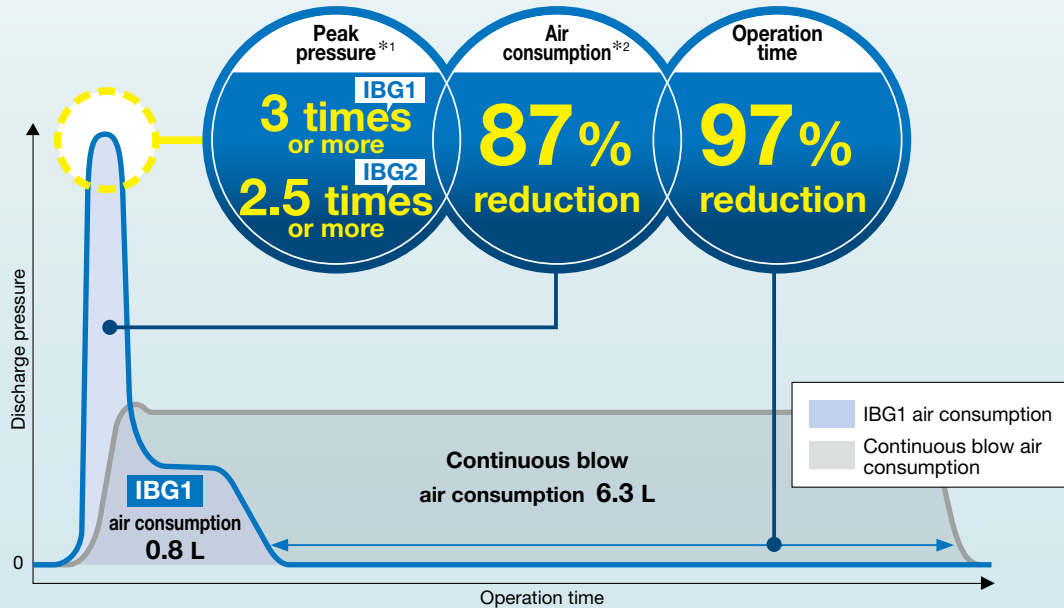

## Increased impact force due to higher peak pressure

Instantaneous air blow reduces air consumption and operation time



Product introduction



Application example video

\*<sup>1</sup> Compared with the existing model (According to blow conditions)

Peak pressure is the pressure that is instantaneously discharged at the start of the blow (discharge pressure). A higher peak pressure is discharged instantaneously compared to the blow pressure (discharge pressure) during continuous blowing. Please note that the discharge pressure is not increased above the supply pressure.

\*<sup>2</sup> Supply pressure: 0.5 MPa (Based on SMC's specific testing conditions)

Series	Function		Option	Nozzle
	Adjuster function with indicator	<b>New</b> Pulse function	<b>New</b> Temperature rise reduction	<b>New</b> Switch nozzle
IBG1	●	—	—	●
IBG2	●	●	●	●

### High Peak Pressure Type IBG1 Series p. 5



Peak pressure: **3 times** or more

### Compact Type IBG2 Series p. 6



Occupied volume: **13% reduction**  
Lightweight: **21% reduction**



**New**  
With pulse function  
With protective cover

**IBG Series**



CAT.ES50-40C

## A compact type has been added.

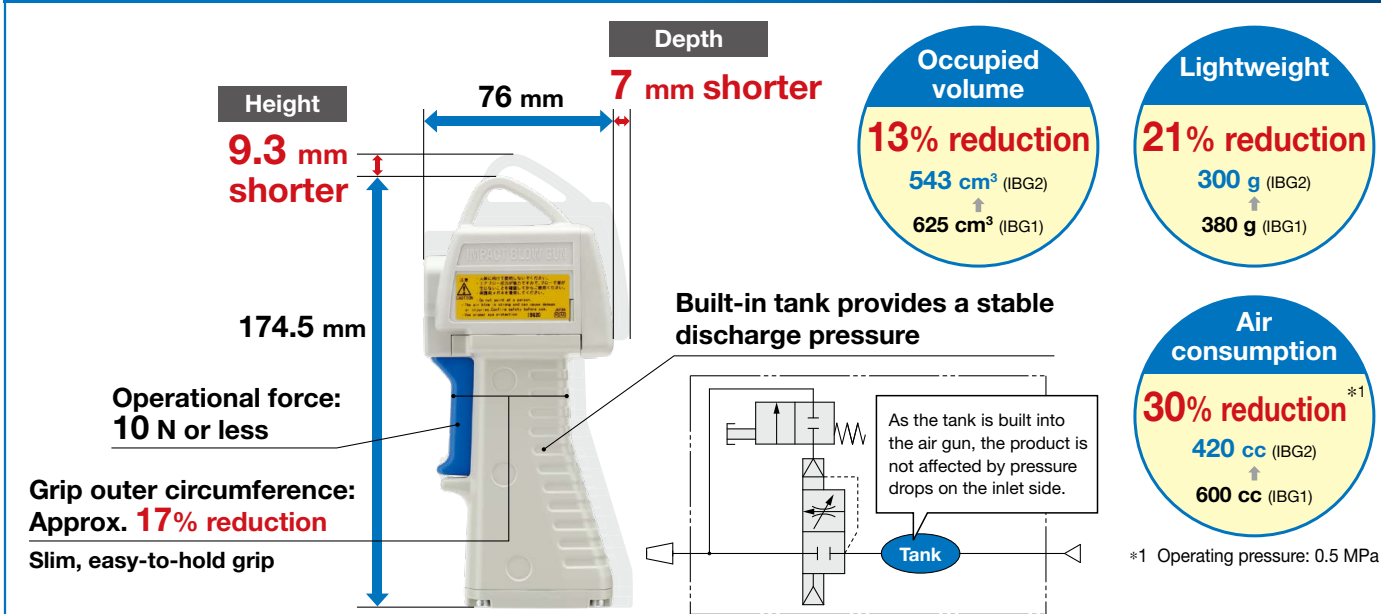

## Peak pressure comparison

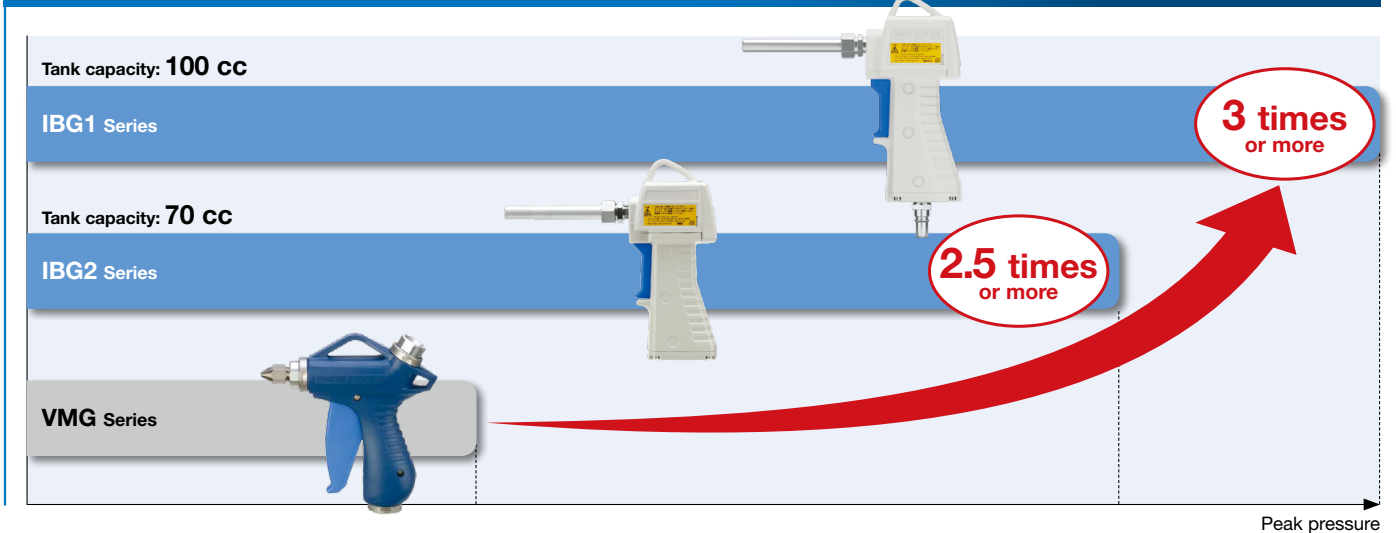

## Variations

Series	Peak pressure*1	Size (Height x Depth x Width) [mm]	Weight [g]	Tank capacity [cc]	Air consumption*2 [cc]	Supply port
<b>High Peak Pressure Type</b> <b>IBG1 Series</b> 	3 times or more	183.8 x 83 x 41	380	100	600	Screw-in type (Rc, NPT, G) 3/8 One-touch fittings ø6 to ø10 ø1/4" to ø3/8" S coupler R3/8
<b>Compact Type</b> <b>IBG2 Series</b> 	2.5 times or more	174.5 x 76 x 41	300	70	420	Screw-in type (Rc, NPT, G) 1/4 One-touch fittings ø6 to ø10 ø1/4" to ø3/8" S coupler R1/4

\*1 Compared with the existing VMG series model \*2 The amount of air filled in the tank at 0.5 MPa operating pressure

## Various Functions

### Adjuster function with indicator

Quick and simple peak pressure adjustment is possible.



**IBG1 Series**



**IBG2 Series**



With protective cover  
Prevention of damage when dropping

Indicator window	Number of needle rotations
0	0
1	1
2	2
3	3
4	4

**Peak pressure and the number of needle rotations**  
(Supply pressure: 0.5 MPa)

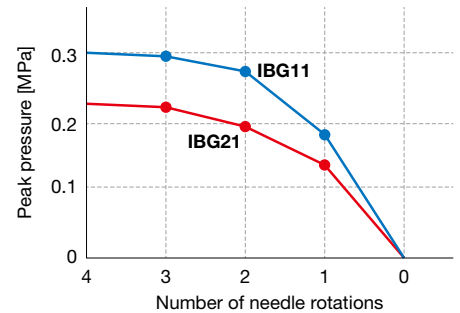

\* Based on SMC's measurement conditions  
\* Without silencer

### **New** Pulse function

The impact blow can be pulsed while the lever is engaged.  
The operating frequency of pulses is adjustable.  
Reduced worker burden



With protective cover  
Prevention of damage when dropping

Operating frequency adjusting needle  
(1 to 8 Hz)

Waveform example of pulse operations

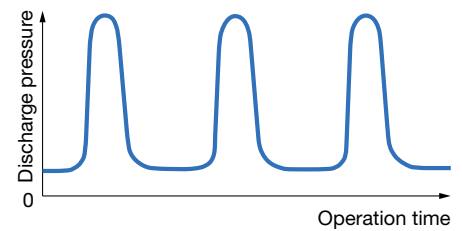

Waveform example of single blow operations

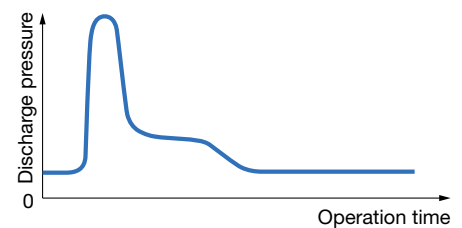

### Long nozzle

Nozzle length:  
50/100/150/300/600/1000 mm



### Long nozzle with a silencer

80 dB (A) or less

\* Based on SMC's measurement conditions



## Various Functions

### Chip guard

Guards against the blown machining chips and workpiece

\* Please order it separately. It is possible to use the guard with a silencer, but in that case, mount the guard before mounting the silencer.

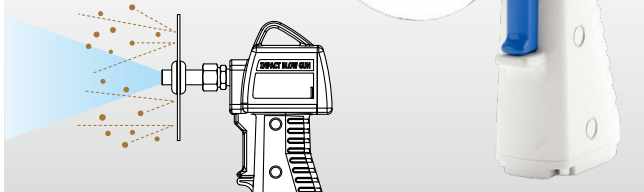

### Compliant with OSHA Standards (U.S. Standards)

Silencer	1910.95: Max. noise level 1910.242B: Max. discharge pressure
Chip guard	1910.242B

### **New** Temperature rise reduction specification

This option will reduce the temperature rise by about 40% on the grip when the product is repeatedly used.

\* Available for only the IBG2 series

### **New** Switch nozzle

By rotating the switch knob, the blow can be switched between impact blow and continuous blow.

Lineup of standard nozzles and nozzles with a silencer

Impact blow



Continuous blow



### With S coupler/ One-touch fitting

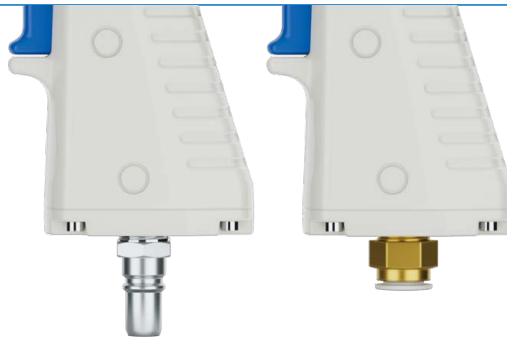

With S coupler

With One-touch fitting

#### Related Product

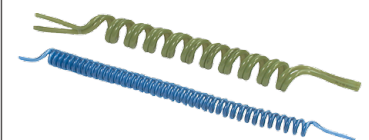

Polyurethane  
Coil Tubing  
TCU



## Application Examples

*For the reliable and simple removal of machining chips, foreign matter, and water droplets*

Powerful  
blow

Reduced  
air  
consumption

Reduced  
operation  
time

For the quick removal of machining chips coated with oil



For the removal of foreign matter with a single shot from a distance



For the separation of workpieces stuck together with oil, etc.

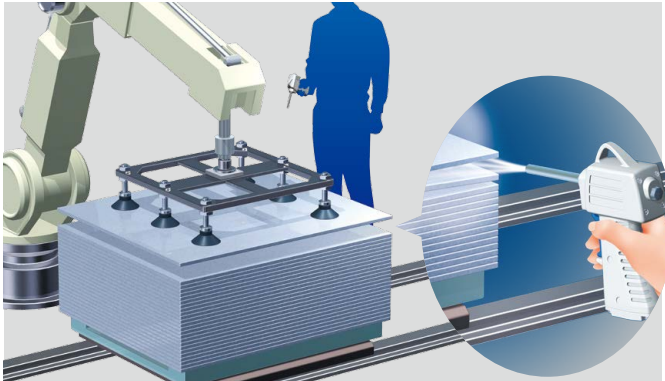

For finishing the removal of water droplets

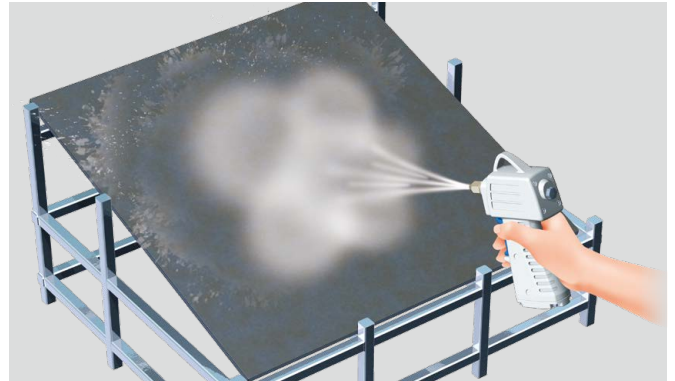

For blowing away sticky soil



For the removal of dust



## CONTENTS



High Peak Pressure Type **Impact Blow Gun**

**IBG1 Series**

How to Order ..... p. 5

Specifications ..... p. 5



Compact Type **Impact Blow Gun**

**IBG2 Series**

How to Order ..... p. 6

Specifications ..... p. 6

Dimensions ..... p. 7

How to Mount a Nozzle ..... p. 11

Specific Product Precautions ..... p. 12

# High Peak Pressure Type Impact Blow Gun **IBG1 Series**

RoHS

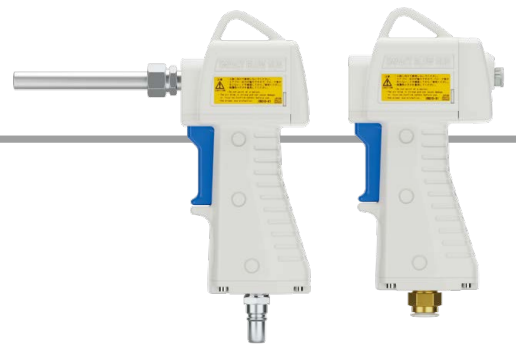

## How to Order

### Symbol

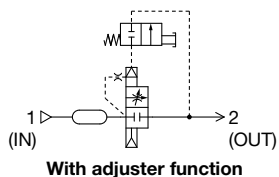
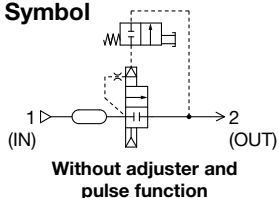

**IBG1 0 - 02**

### Specification

Symbol	Type
0	Without adjuster and pulse function
1	With adjuster function

### Supply port Screw-in type

Symbol	Size
Nil	Rc3/8
N	NPT3/8
F	G3/8

### Nozzle (Refer to page 10 for details.)

Symbol	Type	Nozzle length	Nozzle part no.*2
Nil	Without nozzle	—	—
01	Long nozzle*1	50 mm	IBG1-12-10-50
02		100 mm	IBG1-12-10-100
03		150 mm	IBG1-12-10-150
04		300 mm	IBG1-12-10-300
05		600 mm	IBG1-12-10-600-X1
06		1000 mm	IBG1-12-10-1000-X1
11	Long nozzle with a silencer*1, *3	50 mm	IBG1-12-10-50S
12		100 mm	IBG1-12-10-100S
13		150 mm	IBG1-12-10-150S
14		300 mm	IBG1-12-10-300S
15		600 mm	IBG1-12-10-600S-X1
16		1000 mm	IBG1-12-10-1000S-X1

### With S coupler/One-touch fitting

	Symbol	Applicable tubing O.D.	Part no.	Appearance
S coupler	11	—	KK4P-03MS	
	12	—	KK130P-03MS	
One-touch fitting	H06	ø6	KQ2H06-03AS	
	H08	ø8	KQ2H08-03AS	
	H10	ø10	KQ2H10-03AS	
	H07	ø1/4"	KQ2H07-36AS	
	H09	ø5/16"	KQ2H09-36AS	
	H11	ø3/8"	KQ2H11-36AS	

- \* The S coupler or fitting is shipped together with the product.
- \* For the S coupler or metric size One-touch fitting (H06, H08, H10), the port size on the impact blow gun side is Rc3/8.
- \* For the inch size One-touch fitting (H07, H09, H11), the port size on the impact blow gun side is NPT3/8.

## Specifications

Model	IBG10 (Without adjuster and pulse function)	IBG11 (With adjuster function)
Fluid	Air	
Operating pressure range	0.1 to 0.7 MPa	
Proof pressure	1.05 MPa	
Fluid and ambient temperature range	5 to 60°C	
Operational force	10 N or less	
Weight*1	380 g	400 g

\*1 For the screw-in type

## Chip Guard (Please order it separately.) p. 10

Guards against the blown machining chips and workpiece

Description	Part no.
Chip guard	<b>IBG1-12C</b>

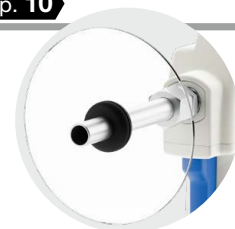

## Switch Nozzle (Please order it separately.) p. 10

Allows for switching between impact blow and continuous blow

Description	Part no.
Switch nozzle	<b>IBG1-12A(S)</b>



# Compact Type

# Impact Blow Gun

# IBG2 Series

RoHS



## How to Order

### Symbol

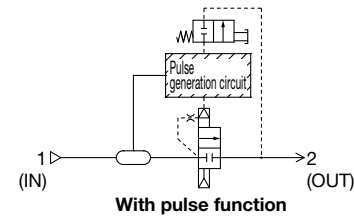
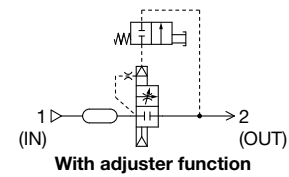
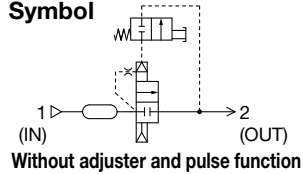

IBG2 0 - 02

### Specification

Symbol	Type
0	Without adjuster and pulse function
1	With adjuster function
2	With pulse function

### Supply port Screw-in type

Symbol	Size
Nil	Rc1/4
N	NPT1/4
F	G1/4

### With S coupler/One-touch fitting

	Symbol	Applicable tubing O.D.	Part no.	Appearance
S coupler	11	—	KK4P-02MS	
	12	—	KK130P-02MS	
One-touch fitting	H06	ø6	KQ2H06-02AS	
	H08	ø8	KQ2H08-02AS	
	H10	ø10	KQ2H10-02AS	
	H07	ø1/4"	KQ2H07-35AS	
	H09	ø5/16"	KQ2H09-35AS	
	H11	ø3/8"	KQ2H11-35AS	

- \* The S coupler or fitting is shipped together with the product.
- \* For the S coupler or metric size One-touch fitting (H06, H08, H10), the port size on the impact blow gun side is Rc1/4.
- \* For the inch size One-touch fitting (H07, H09, H11), the port size on the impact blow gun side is NPT1/4.

## Specifications

Model	IBG20 (Without adjuster and pulse function)	IBG21 (With adjuster function)	IBG22 (With pulse function)
Fluid	Air		
Operating pressure range	0.1 to 0.7 MPa	0.25 to 0.7 MPa	
Operating frequency	—	—	1 to 8 Hz
Proof pressure	1.05 MPa		
Fluid and ambient temperature range	5 to 60°C		
Operational force	10 N or less		
Weight*1	300 g	320 g	370 g

\*1 For the screw-in type

### Nozzle (Refer to page 10 for details.)

Symbol	Type	Nozzle length	Nozzle part no.*2
Nil	Without nozzle	—	—
01	Long nozzle*1	50 mm	IBG1-12-10-50
02		100 mm	IBG1-12-10-100
03		150 mm	IBG1-12-10-150
04		300 mm	IBG1-12-10-300
05		600 mm	IBG1-12-10-600-X1
06	1000 mm	IBG1-12-10-1000-X1	
11	Long nozzle with a silencer*1, *3	50 mm	IBG1-12-10-50S
12		100 mm	IBG1-12-10-100S
13		150 mm	IBG1-12-10-150S
14		300 mm	IBG1-12-10-300S
15		600 mm	IBG1-12-10-600S-X1
16		1000 mm	IBG1-12-10-1000S-X1

- \*1 A long nozzle and a silencer are included in a package but do not come mounted. Refer to page 11 for assembly procedures.
- \*2 This is the part number for the long nozzle and fitting set.
- \*3 The silencer and long nozzle can be used together. Part number for ordering a silencer alone is **IBG1-12S**.
- \* For the IBG22, only 11, 12 and 13 options are available. Refer to Specific Product Precautions 1 on page 12.

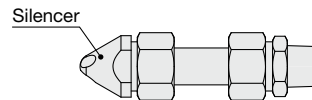

### Option

Nil	None
T	Temperature rise reduction specification

## Chip Guard (Please order it separately.) p. 10

Guards against the blown machining chips and workpiece

Description	Part no.
Chip guard	<b>IBG1-12C</b>

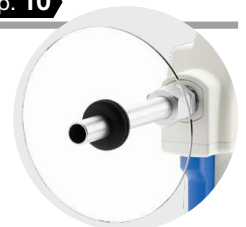

## Switch Nozzle (Please order it separately.) p. 10

Allows for switching between impact blow and continuous blow

Description	Part no.
Switch nozzle	<b>IBG1-12A(S)</b>



# IBG Series

## Dimensions

### IBG10/Without adjuster and pulse function

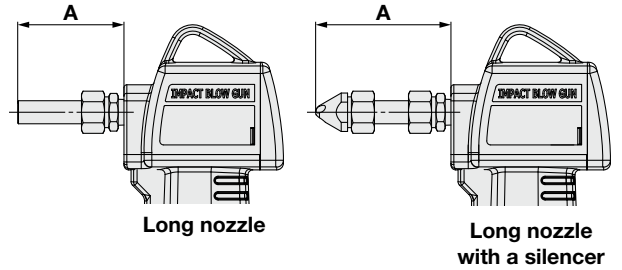
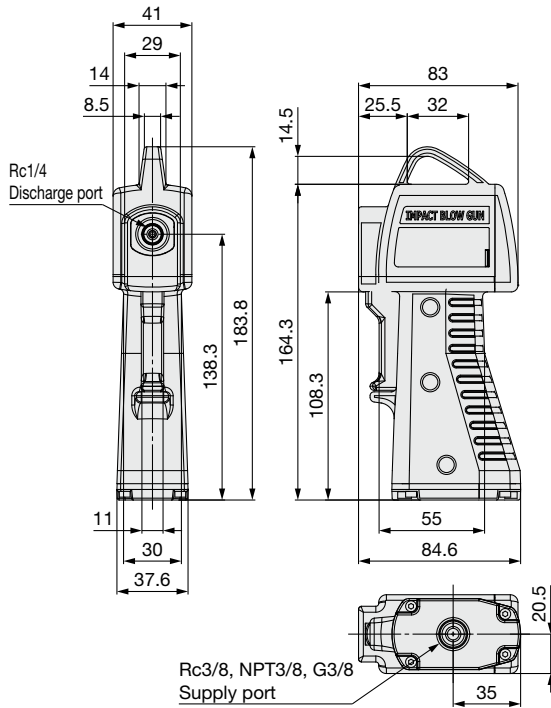

Symbol	Type	Nozzle length [mm]	Nozzle part no.	A [mm]	Weight [g]
01	Long nozzle	50	IBG1-12-10-50	57	35
02		100	IBG1-12-10-100	107	40
03		150	IBG1-12-10-150	157	45
04		300	IBG1-12-10-300	307	59
05		600	IBG1-12-10-600-X1	607	88
06		1000	IBG1-12-10-1000-X1	1007	126
11	Long nozzle with a silencer	50	IBG1-12-10-50S	72	57
12		100	IBG1-12-10-100S	122	62
13		150	IBG1-12-10-150S	172	67
14		300	IBG1-12-10-300S	322	81
15		600	IBG1-12-10-600S-X1	622	110
16		1000	IBG1-12-10-1000S-X1	1022	148

### IBG11/ With adjuster function

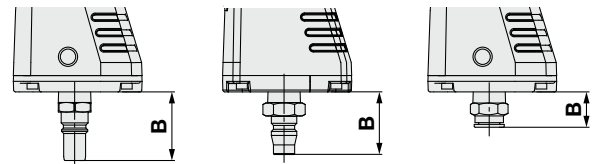
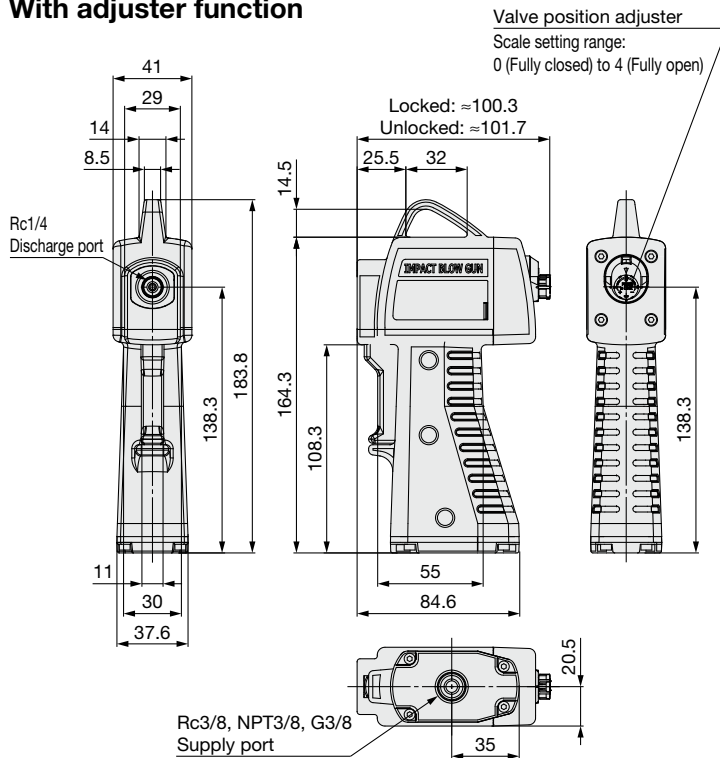

Symbol	Type	Applicable tubing O.D.	Part no.	B [mm]
11	S coupler	—	KK4P-03MS	35.7
12		—	KK130P-03MS	32.5
H06	Metric size	ø6	KQ2H06-03AS	13
H08	One-touch fitting	ø8	KQ2H08-03AS	13
H10		ø10	KQ2H10-03AS	18.4
H07	Inch size	ø1/4"	KQ2H07-36AS	13.4
H09	One-touch fitting	ø5/16"	KQ2H09-36AS	13.4
H11		ø3/8"	KQ2H11-36AS	18





## Dimensions

### IBG20/Without adjuster and pulse function

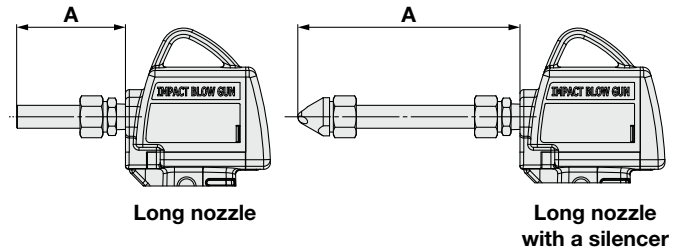
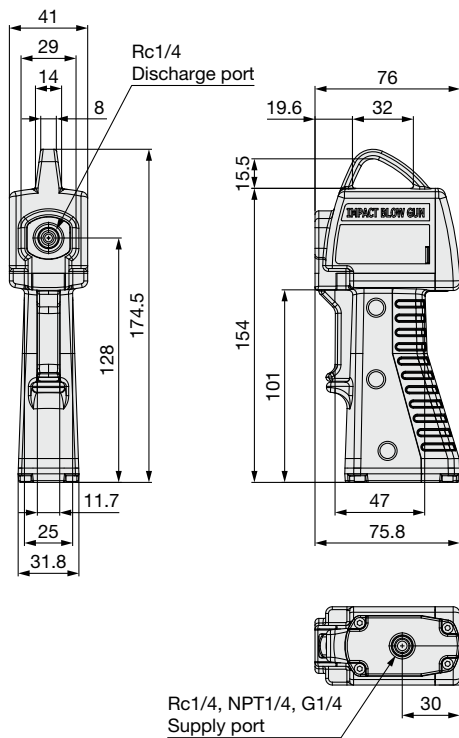

Symbol	Type	Nozzle length [mm]	Nozzle part no.	A [mm]	Weight [g]
<b>01</b>	Long nozzle	50	IBG1-12-10-50	57	35
<b>02</b>		100	IBG1-12-10-100	107	40
<b>03</b>		150	IBG1-12-10-150	157	45
<b>04</b>		300	IBG1-12-10-300	307	59
<b>05</b>		600	IBG1-12-10-600-X1	607	88
<b>06</b>		1000	IBG1-12-10-1000-X1	1007	126
<b>11</b>	Long nozzle with a silencer	50	IBG1-12-10-50S	72	57
<b>12</b>		100	IBG1-12-10-100S	122	62
<b>13</b>		150	IBG1-12-10-150S	172	67
<b>14</b>		300	IBG1-12-10-300S	322	81
<b>15</b>		600	IBG1-12-10-600S-X1	622	110
<b>16</b>		1000	IBG1-12-10-1000S-X1	1022	148

### IBG21/With adjuster function

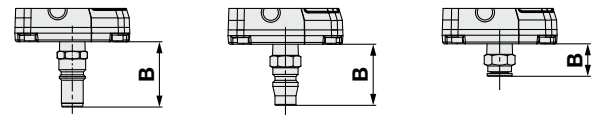
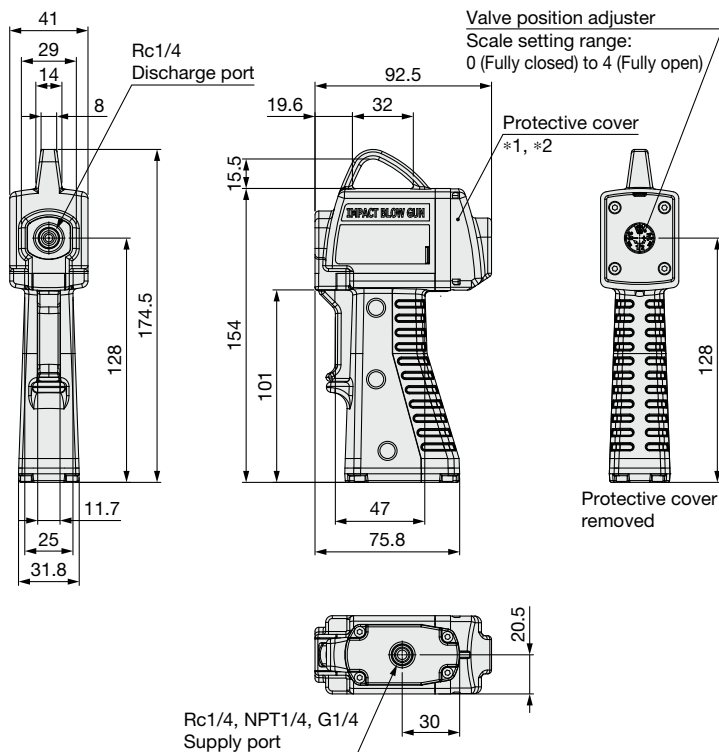

Symbol	Type	Applicable tubing O.D.	Part no.	B [mm]	
<b>11</b>	S coupler	—	KK4P-02MS	34.2	
<b>12</b>		—	KK130P-02MS	32	
<b>H06</b>	Metric size	ø6	KQ2H06-02AS	12	
<b>H08</b>	One-touch fitting	ø8	KQ2H08-02AS	17.3	
<b>H10</b>		ø10	KQ2H10-02AS	22.6	
<b>H07</b>	Inch size	ø1/4"	KQ2H07-35AS	12.3	
<b>H09</b>		One-touch fitting	ø5/16"	KQ2H09-35AS	17.7
<b>H11</b>			ø3/8"	KQ2H11-35AS	20.7

\*1 Protective cover material: Polycarbonate (transparent)  
 \*2 Refer to the operation manual for protective cover mounting and removal.

# IBG Series

## Dimensions

### IBG22/With pulse function

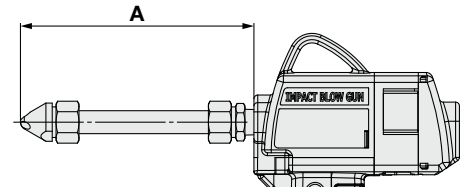
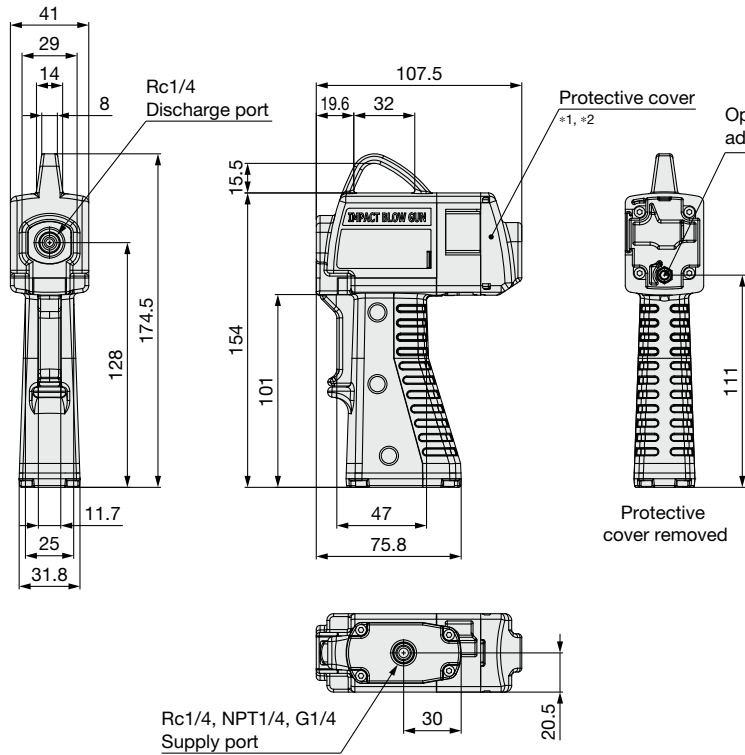

Long nozzle with a silencer

Symbol	Type	Nozzle length [mm]	Nozzle part no.	A [mm]	Weight [g]
<b>11</b>	Long nozzle with a silencer	50	IBG1-12-10-50S	72	57
<b>12</b>		100	IBG1-12-10-100S	122	62
<b>13</b>		150	IBG1-12-10-150S	172	67

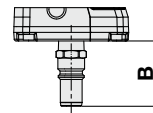

With S coupler plug mounted  
KK4P-02MS

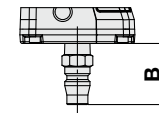

With S coupler plug mounted  
KK130P-02MS

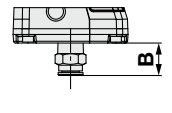

With One-touch fitting mounted  
KQ2H□-□AS

- \*1 Protective cover material: Polycarbonate (transparent)
- \*2 Refer to the operation manual for protective cover mounting and removal.

Symbol	Type	Applicable tubing O.D.	Part no.	B [mm]
<b>11</b>	S coupler	—	KK4P-02MS	34.2
<b>12</b>		—	KK130P-02MS	32
<b>H06</b>	Metric size	ø6	KQ2H06-02AS	12
<b>H08</b>	One-touch fitting	ø8	KQ2H08-02AS	17.3
<b>H10</b>		ø10	KQ2H10-02AS	22.6
<b>H07</b>	Inch size	ø1/4"	KQ2H07-35AS	12.3
<b>H09</b>	One-touch fitting	ø5/16"	KQ2H09-35AS	17.7
<b>H11</b>		ø3/8"	KQ2H11-35AS	20.7

## Dimensions

### Long nozzle (Option)

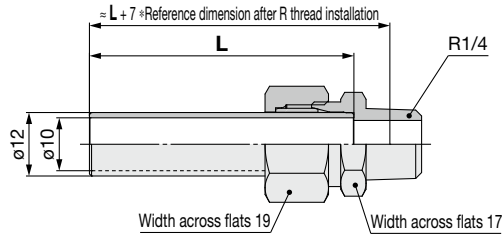

Part no.	Nozzle I.D.	Connection thread	L [mm]
<b>IBG1-12-10-50</b>	ø10	R1/4	50
<b>IBG1-12-10-100</b>			100
<b>IBG1-12-10-150</b>			150
<b>IBG1-12-10-300</b>			300
<b>IBG1-12-10-600-X1</b>			600
<b>IBG1-12-10-1000-X1</b>			1000

### Long nozzle with a silencer (Option)

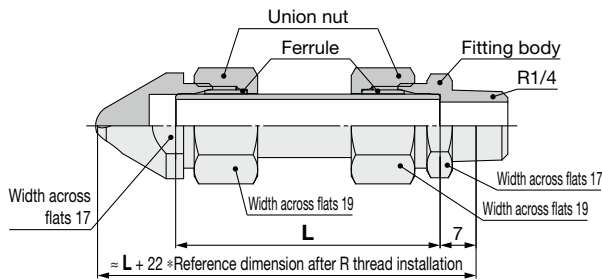

Part no.	L [mm]
<b>IBG1-12-10-50S</b>	50
<b>IBG1-12-10-100S</b>	100
<b>IBG1-12-10-150S</b>	150
<b>IBG1-12-10-300S</b>	300
<b>IBG1-12-10-600S-X1</b>	600
<b>IBG1-12-10-1000S-X1</b>	1000

### Chip guard (Please order it separately.)

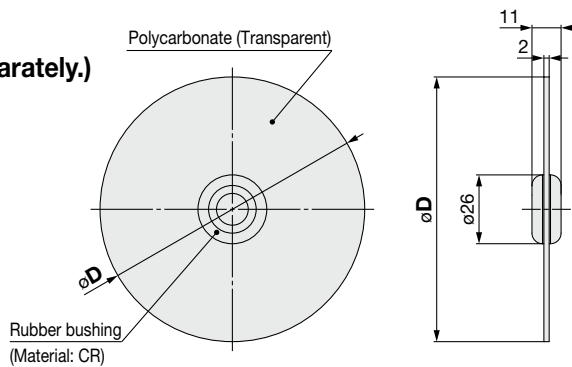

Part no.	øD [mm]
<b>IBG1-12C</b>	100

- \* The rubber bushing is shipped together with the product.
- \* It is possible to use the guard with a silencer, but in that case, mount the guard before mounting the silencer.

### Switch nozzle (Please order it separately.) IBG1-12A(S)

\* For impact blow

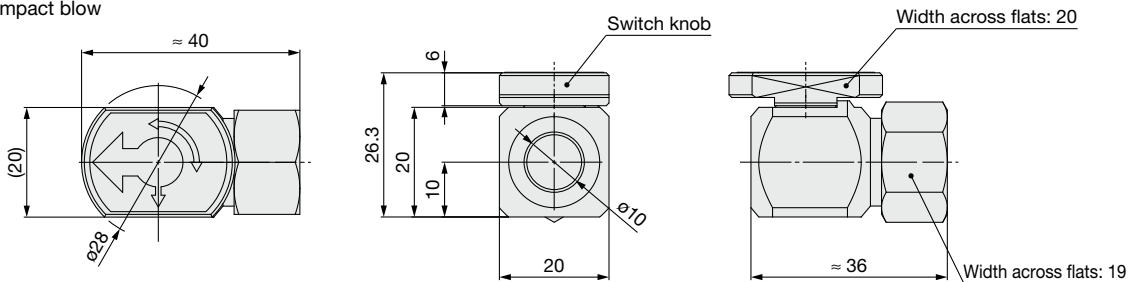

\* For continuous blow

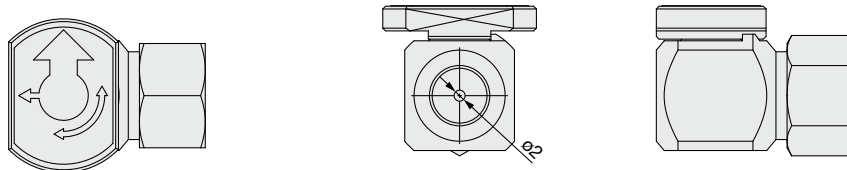

Part no.	Type	Nozzle conversion
<b>IBG1-12A</b>	Standard	Impact blow $\leftrightarrow$ Continuous blow ( $\phi 2$ )
<b>IBG1-12AS</b>	Silent	Impact blow $\leftrightarrow$ Continuous blow ( $\phi 2$ )

- \* Attach to the end of the long nozzle for use.
- \* For installation methods, refer to the "How to Mount a Nozzle" on page 11 or the operation manual.
- \* Continuous blowing is not pulsed, so cannot be used together with a pulse function.

## How to Mount a Nozzle

### Preparation

- 1 Check that the ferrule is mounted inside the fitting as shown in the figure below. Hand-tighten the union nut. Ensure the ferrule is aligned properly.

Tighten the union nut until it touches the body.

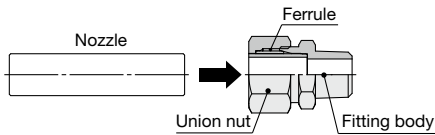

- 2 Insert the nozzle until it touches the fitting body. Then, mark a line on the nozzle at the edge of the union nut.

Insert the nozzle until it touches the bottom of the fitting body.

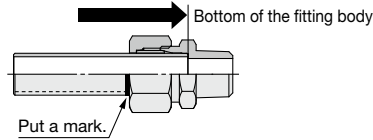

- 3 Remove the nozzle once, and check the dimension from the end of the nozzle to the marking. If the dimension is different from the 17 mm, verify the alignment of the nozzle and adjust.

Remove it once, and check the dimension.

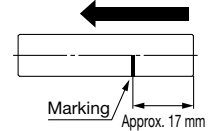

### Tightening

- 4 After verifying the dimension, insert the nozzle into the fitting body again. Confirm that the nozzle is inserted down to the marking.

Insert to the marking.

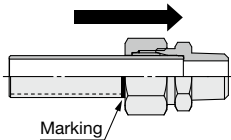

- 5 Using the tightening tool, tighten the union nut so that the gap between the fitting body and the union nut becomes 2 mm or less.

Tighten the union nut so that the clearance is 2 mm or less.

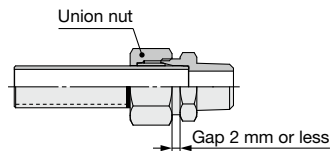

- 6 Pull the nozzle by hand to ensure that the nozzle is secure. Before operation, pull the nozzle by hand again to confirm that the nozzle is securely attached and will not be ejected during operation.



# IBG Series

## Specific Product Precautions 1

Be sure to read this before handling the products. Refer to the back cover for safety instructions. For other precautions, refer to the “Handling Precautions for SMC Products” and the “Operation Manual” on the SMC website: <https://www.smcworld.com>

### Prior to Use

#### ⚠ Warning

As the pressure of the air blow is quite powerful, do not aim the product at another person during operation. It may cause danger to personnel. Additionally, the following precautions should be taken before use.

1. Before use, make sure that the blow pressure, or blow, will not cause surrounding objects to scatter and injure others or damage workpieces, equipment, etc., in the vicinity.
2. Wear protective eyewear when operating the product to protect your eyes from scattering debris.
3. This product is not a toy. Do not play with the product or use it as an air gun for fun.
4. Air pressure may cause the nozzle to fly off during operation if it is not properly tightened. To prevent this, be sure to check the nozzle for loosening by pulling on it with your hands before use.
5. The grip may become hot due to repeated operation; however, this is not abnormal. Select the temperature rise reduction specification (IBG2 series only) if an increase in product temperature may cause issues.
6. To make the most of this product's specifications (high peak pressure discharge), we recommend installing a dedicated nozzle on the outlet side. Using a nozzle of a smaller diameter than the dedicated nozzle will result in continuous blow.

#### ⚠ Caution

Please read the following for IBG22/specification with pulse function.

1. Only IBG1-12-10-(50, 100, 150)S: long nozzle with silencing nozzle can be selected. Other nozzles can be operated, but oscillation of the main valve may result in increased operating noise and reduced service life.
2. When changing pressure from the high pressure side to the low pressure side, gradually decrease the pressure while holding the lever.
3. Note that if the nozzle diameter is small, the blow air is not pulsed and is in a continuous blowing state. Therefore, it cannot be used in combination with switching nozzles.
4. Because of mechanical intermittent operation by compressed air, the air discharge state may vary depending on the frequency of operation, supply pressure, temperature, etc.

### Selection

#### ⚠ Warning

1. Confirm the specifications.

Products represented in this catalog are designed only for use in compressed air systems. Do not operate at pressures, temperatures, etc., beyond the range of specifications, as this can cause damage or malfunction.

#### ⚠ Caution

1. Do not apply the blow gun to flammable, explosive, or toxic substances such as gas, fuel gas, or refrigerant. Such substances may exude from inside the blow gun.

### Mounting

#### ⚠ Warning

1. Install a stop valve on the supply pressure side of the blow gun.

It will be emergency shut off in case of unexpected leakage or damage.

2. When installing a nozzle on the blow gun, wind sealant tape around the threads of the nozzle.
3. Screw-in the nozzle to the torque below by holding the flat faces on the discharge side or metal holder. As a guideline, it is equivalent to 2 to 3 additional turns with a tool after hand-tightening.

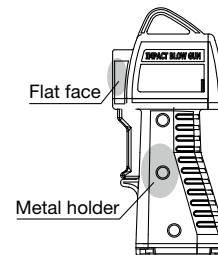

Nozzle tightening torque range	12 to 14 N·m
--------------------------------	--------------

Insufficient tightening may cause loosening of the nozzle.



## IBG Series

# Specific Product Precautions 2

Be sure to read this before handling the products. Refer to the back cover for safety instructions. For other precautions, refer to the “Handling Precautions for SMC Products” and the “Operation Manual” on the SMC website: <https://www.smcworld.com>

### Piping

#### Caution

- 1. Check the model, type, and size before installation.**  
Also, confirm that there are no scratches, gouges, or cracks on the product.
- 2. Preparation before piping**  
Before piping is connected, it should be thoroughly blown out with air (flushing) or washed to remove chips, cutting oil, and other debris from inside the pipe.
- 3. When tightening the threads, tighten with torque specified in the table below. As a guideline, it is equivalent to 2 to 3 additional turns with a tool after hand-tightening.**  
Be careful that tightening with torque beyond the range in the table below may cause damage to the body.
 

Male thread	Tightening torque [N·m]
R1/4	12 to 14
R3/8	22 to 24
- 4. Allow extra length when connecting a tube to accommodate changes in tube length due to pressure.**
- 5. Confirm that no twisting, turning, or tensile force or moment load is applied to the port or tube. This may cause fittings to fracture or tubes to be crushed, burst, or come loose.**
- 6. Do not abrade, entangle, or scratch the tube. This may cause the tube to be crushed, burst, or come loose.**

### Lubrication

#### Warning

- 1. Do not lubricate the product.**  
It may contaminate or damage the target object.

### Air Supply

#### Warning

- 1. Use clean air.**  
Do not use compressed air that contains chemicals, synthetic oils that include organic solvents, salt, corrosive gases, etc., as it can cause damage or malfunction.

#### Caution

- 1. Install an air filter.**  
Install an air filter upstream near the blow gun. Select an air filter with a filtration size of 5 µm or smaller.
- 2. Take measures to ensure air quality, such as by installing an aftercooler, air dryer, or water separator.**  
Compressed air that contains a large amount of drainage can cause the malfunction of the blow gun and contaminate or damage the target object. Therefore, take appropriate measures to ensure air quality, such as by providing an aftercooler, air dryer, or water separator.

### Operating Environment

#### Warning

- 1. Do not use in an atmosphere where corrosive gases, chemicals, sea water, water, or water steam are present. Do not use in cases where there is direct contact with any of the above.**
- 2. Do not expose the product to direct sunlight for an extended period of time.**
- 3. Do not use in locations where radiated heat will be received from nearby heat sources.**
- 4. Do not use in an environment where static electricity is a problem. It may result in system failure or malfunction. Please contact SMC for use in such an environment.**
- 5. Do not use in an environment where spatters are generated. Spattering may result in a fire hazard. Please contact SMC for use in such an environment.**
- 6. Do not use in an environment where the product is exposed to cutting oil, lubricating oil, or coolant oil. Please contact SMC for use in such an environment.**

### Maintenance

#### Caution

- 1. In periodical inspections, check the following items and replace the parts if necessary.**
  - Scratches, gouges, abrasion, corrosion
  - Air leakage
  - Twisting, crushing, and turning of connected tubes
  - Hardening, deterioration, and softening of connected tubes
  - Loosening of nozzles
- 2. When removing the product, first stop the pressure supply, exhaust compressed air in the piping, and check the condition of atmospheric release.**
- 3. Do not disassemble or remodel the body of the product.**
- 4. As contact with solvents such as ethanol may cause the protective cover to become cloudy or cracked, be careful when cleaning.**



## IBG Series

# Specific Product Precautions 3

Be sure to read this before handling the products. Refer to the back cover for safety instructions. For other precautions, refer to the “Handling Precautions for SMC Products” and the “Operation Manual” on the SMC website: <https://www.smcworld.com>

### Handling

#### Warning

1. Air pressure may cause the nozzle to fly off during operation if it is not properly tightened. To prevent this, be sure to check the nozzle for loosening by pulling on it with your hands before use.
2. Be sure to wear protective eyewear when operating the product to protect your eyes from scattering debris.
3. Do not direct the tip of the nozzle at the face or other parts of a human body. It may cause danger to personnel.
4. Do not use the product to clean or remove toxic substances or chemicals.
5. Do not drop, step on, or hit the product. It may cause damage to the product.
6. Do not use the product to disturb public order or public hygiene.
7. This product is not a toy.
8. After blowing, make sure to hang the product on a hook, etc.

If leaving the product in a dusty place, particles will enter the product and may result in a malfunction.

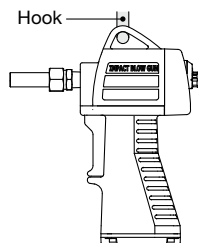

9. When the blow gun is used or stored, confirm that no twisting, turning, or tensile force or moment load is applied to the port or tube. This may cause fittings to fracture or tubes to be crushed, burst, or come loose.

#### Caution

1. Pressurizing the air blow discharge port may result in the breakage of the product.
2. For the IBG11/IBG21, the blow adjusting range 4 provides the maximum blow. Rotating the adjuster exceeding 4 may result in the breakage of the product.
3. The operating frequency is adjusted by turning the needle on the IBG22. If the setting needle is turned too far, this may result in continuous air blowing.

## Safety Instructions

These safety instructions are intended to prevent hazardous situations and/or equipment damage. These instructions indicate the level of potential hazard with the labels of “**Caution**,” “**Warning**” or “**Danger**.” They are all important notes for safety and must be followed in addition to International Standards (ISO/IEC)\*1, and other safety regulations.

 **Danger :** **Danger** indicates a hazard with a high level of risk which, if not avoided, will result in death or serious injury.

 **Warning:** **Warning** indicates a hazard with a medium level of risk which, if not avoided, could result in death or serious injury.

 **Caution:** **Caution** indicates a hazard with a low level of risk which, if not avoided, could result in minor or moderate injury.

\*1) ISO 4414: Pneumatic fluid power - General rules and safety requirements for systems and their components  
ISO 4413: Hydraulic fluid power - General rules and safety requirements for systems and their components  
IEC 60204-1: Safety of machinery - Electrical equipment of machines - Part 1: General requirements  
ISO 10218-1: Robots and robotic devices - Safety requirements for industrial robots - Part 1: Robots etc.

### Warning

#### 1. The compatibility of the product is the responsibility of the person who designs the equipment or decides its specifications.

Since the product specified here is used under various operating conditions, its compatibility with specific equipment must be decided by the person who designs the equipment or decides its specifications based on necessary analysis and test results. The expected performance and safety assurance of the equipment will be the responsibility of the person who has determined its compatibility with the product. This person should also continuously review all specifications of the product referring to its latest catalog information, with a view to giving due consideration to any possibility of equipment failure when configuring the equipment.

#### 2. Only personnel with appropriate training should operate machinery and equipment.

The product specified here may become unsafe if handled incorrectly. The assembly, operation and maintenance of machines or equipment including our products must be performed by an operator who is appropriately trained and experienced.

#### 3. Do not service or attempt to remove product and machinery/equipment until safety is confirmed.

1. The inspection and maintenance of machinery/equipment should only be performed after measures to prevent falling or runaway of the driven objects have been confirmed.
2. When the product is to be removed, confirm that the safety measures as mentioned above are implemented and the power from any appropriate source is cut, and read and understand the specific product precautions of all relevant products carefully.
3. Before machinery/equipment is restarted, take measures to prevent unexpected operation and malfunction.

#### 4. SMC products cannot be used beyond their specifications. They are not developed, designed, and manufactured to be used under the following conditions or environments. Use under such conditions or environments is not allowed.

1. Conditions and environments outside of the given specifications, or use outdoors or in a place exposed to direct sunlight.
2. Use for nuclear power, railways, aviation, space equipment, ships, vehicles, military application, equipment affecting human life, body, and property, combustion equipment, entertainment equipment, emergency shut-off circuits, press clutches, brake circuits, safety equipment, etc., and use for applications that do not conform to standard specifications such as catalogs and operation manuals.
3. Use for interlock circuits, except for use with double interlock such as installing a mechanical protection function in case of failure. Please periodically inspect the product to confirm that the product is operating properly.

### Caution

**SMC develops, designs, and manufactures products to be used for automatic control equipment, and provides them for peaceful use in manufacturing industries.**

**Use in non-manufacturing industries is not allowed.**

Products SMC manufactures and sells cannot be used for the purpose of transactions or certification specified in the Measurement Act of each country. The new Measurement Act prohibits use of any unit other than SI units in Japan.

### Limited warranty and Disclaimer/ Compliance Requirements

The product used is subject to the following “Limited warranty and Disclaimer” and “Compliance Requirements”.

Read and accept them before using the product.

#### Limited warranty and Disclaimer

1. The warranty period of the product is 1 year in service or 1.5 years after the product is delivered, whichever is first.\*2)  
Also, the product may have specified durability, running distance or replacement parts. Please consult your nearest sales branch.
2. For any failure or damage reported within the warranty period which is clearly our responsibility, a replacement product or necessary parts will be provided.  
This limited warranty applies only to our product independently, and not to any other damage incurred due to the failure of the product.
3. Prior to using SMC products, please read and understand the warranty terms and disclaimers noted in the specified catalog for the particular products.

\*2) **Suction cups (Vacuum pads) are excluded from this 1 year warranty.**

A suction cup (vacuum pad) is a consumable part, so it is warranted for a year after it is delivered.

Also, even within the warranty period, the wear of a product due to the use of the suction cup (vacuum pad) or failure due to the deterioration of rubber material are not allowed by the limited warranty.

#### Compliance Requirements

1. The use of SMC products with production equipment for the manufacture of weapons of mass destruction (WMD) or any other weapon is strictly prohibited.
2. The exports of SMC products or technology from one country to another are governed by the relevant security laws and regulations of the countries involved in the transaction. Prior to the shipment of a SMC product to another country, assure that all local rules governing that export are known and followed.

#### Revision History

**Edition B** \* The IBG2 series has been added.  
\* The number of pages has been increased from 8 to 12.

**Edition C** \* A type with a pulse function has been added to the IBG2 series.  
\* The number of pages has been increased from 12 to 16.

 **Safety Instructions** Be sure to read the “Handling Precautions for SMC Products” (M-E03-3) and “Operation Manual” before use.