

Compact Guide Cylinder

ø12, ø16, ø20, ø25, ø32, ø40, ø50

RoHS

New • A type with an air cushion has been added for bore sizes ø12 to ø50.

Volume

Max. **28%** reduction

538 cm³ → **390 cm³**

Compared with the MGPM, ø32, 25 mm stroke

Weight

Max. **41%** reduction

0.32 kg → **0.19 kg**

Compared with the existing model (MGPM), ø16, 10 mm stroke

High rigidity

Optimized configuration allows for compact body with high rigidity

The lateral load, allowable kinetic energy, and non-rotating accuracy are equivalent to those of the existing model (MGP-Z).

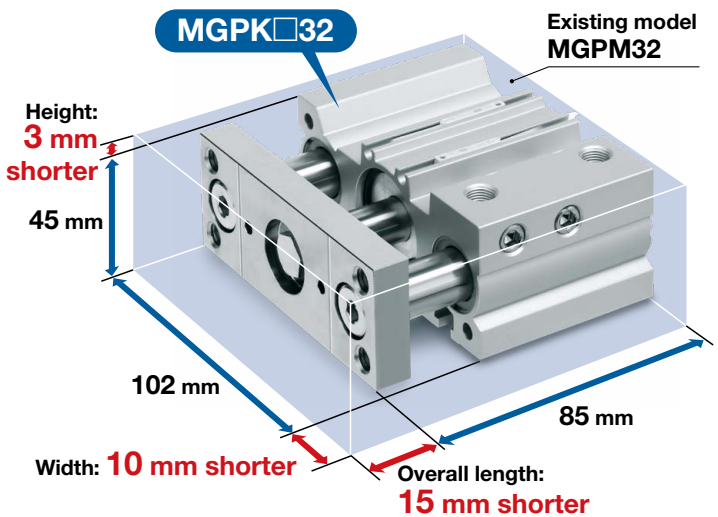

MGPK Series

SMC
CAT.ES20-270C A

Plate thickness increased by up to **33%** Higher rigidity

ø50 12 mm → **16 mm**

The plate material is selectable.

- Carbon steel
- Aluminum alloy (Allows for reduced weight)

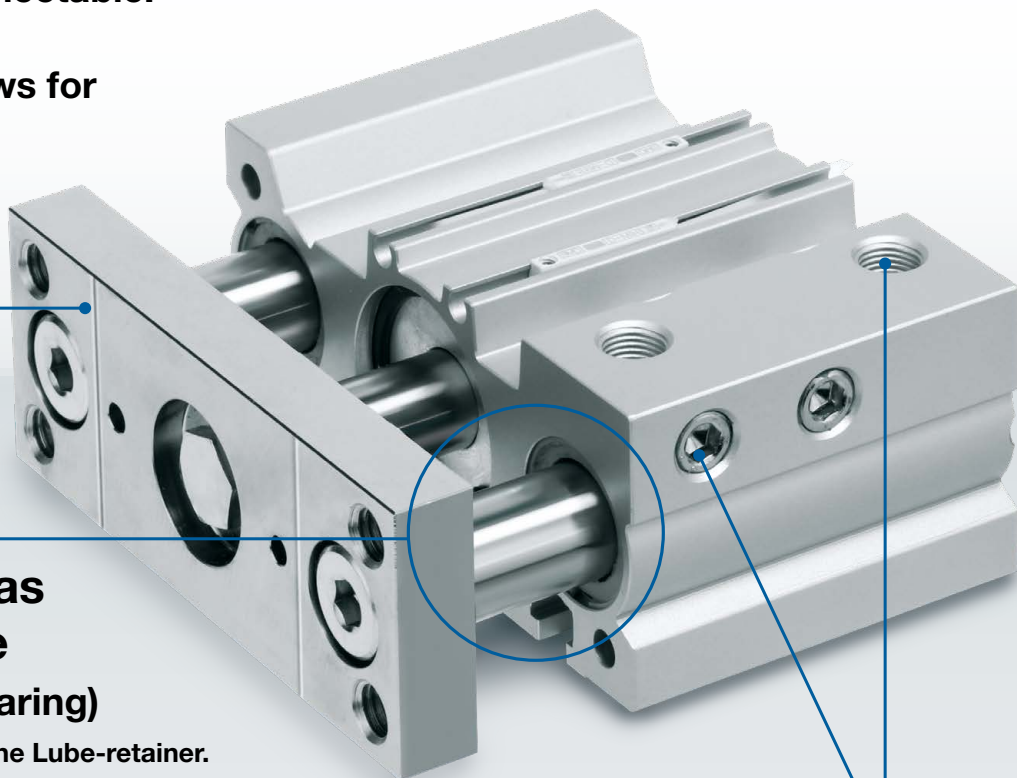

A Lube-retainer has been added to the guide rod. (Slide bearing)

- Lubrication is maintained by the Lube-retainer.
- Prevents the entry of foreign matter

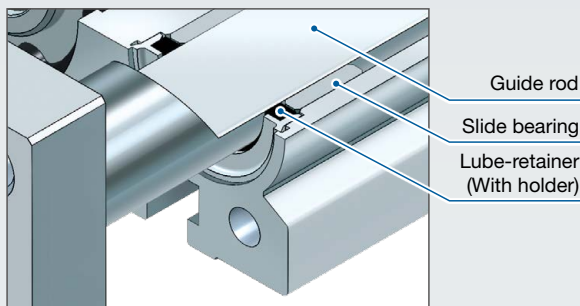

2 types of piping port locations can be selected.

ø12 to ø50

1 Top ported

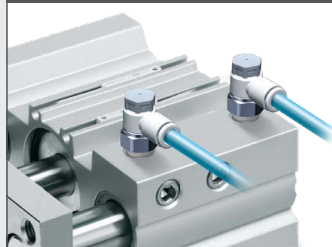

2 Side ported



ø12, ø16 (Without port plugs on the side)

Top ported

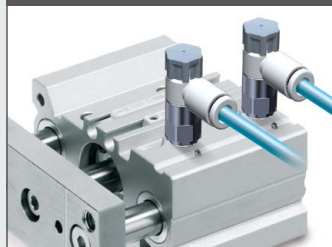

Since the only ports are on the top surface, no plugs are required on the side, meaning **the width of the body can be reduced.**

Application Examples

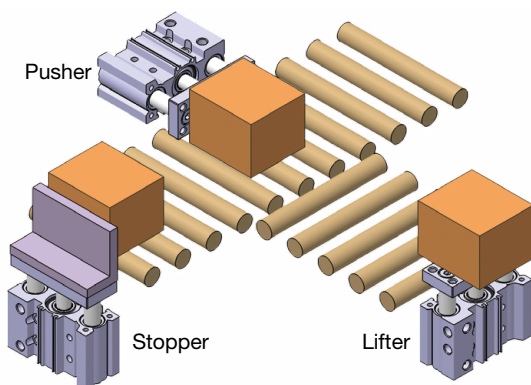

4 types of mounting are possible.

- Easy positioning
- Knock pin holes provided on each mounting surface

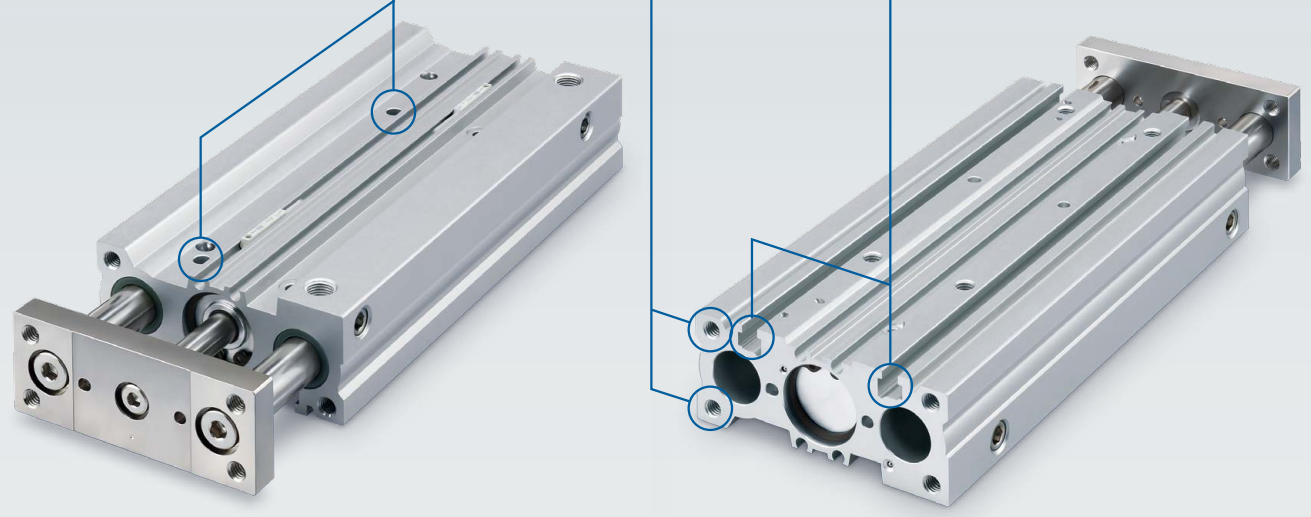
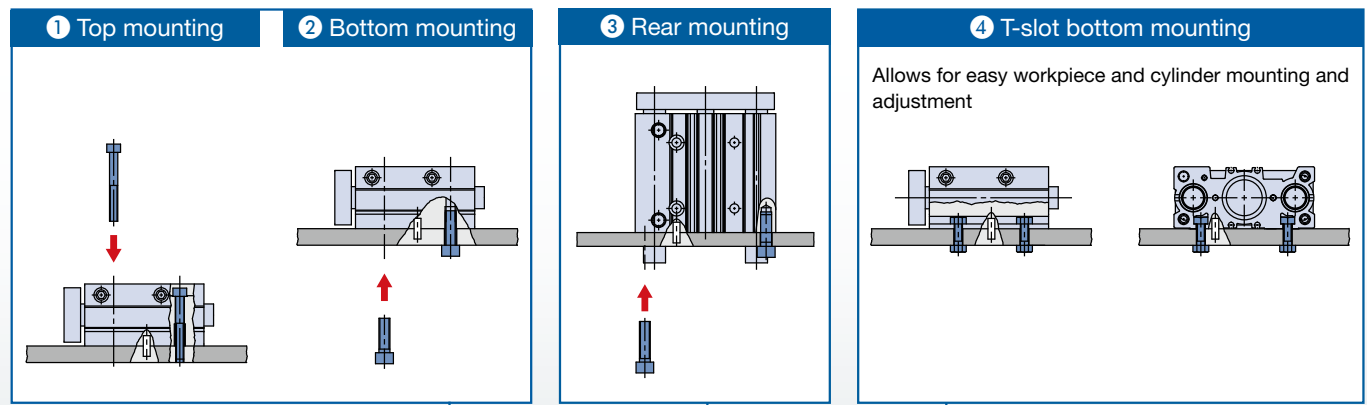

Small auto switches can be directly mounted on 2 surfaces.

D-M9 D-A9

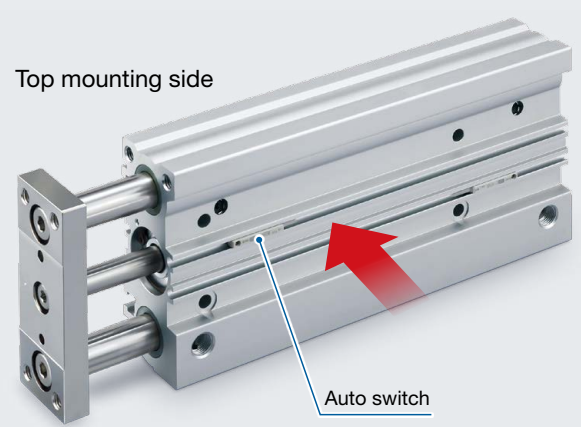

New A type with an air cushion has been added.

- The performance and strength are equivalent to those of the existing MGP series product with an air cushion.
- The bumper reduces metallic noise when the piston stops.

Weight: Max. 33% reduction 1.65 kg → 1.1 kg

Compared with the existing MGP series product, With air cushion, ø32, 25 mm stroke

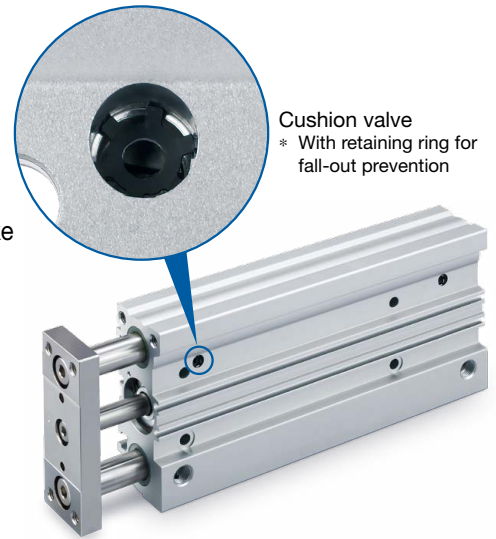
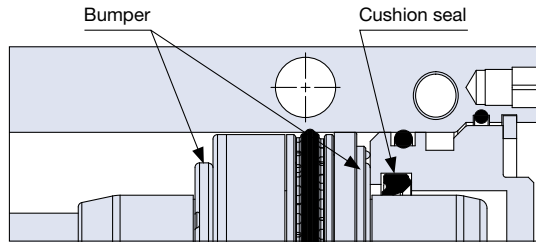

Adopts an air cushion + rubber bumper combined structure



MGPK Series (With Air Cushion) Stroke Variations

Bearing type	Bore size [mm]	Stroke [mm]								
		25	50	75	100	125	150	175	200	
 MGPKM-□H Slide bearing	ø12	•	•	•	•	•	•			
	ø16	•	•	•	•	•	•			
	ø20	•	•	•	•	•	•	•		•
	ø25	•	•	•	•	•	•	•	•	•
	ø32	•	•	•	•	•	•	•	•	•
	ø40	•	•	•	•	•	•	•	•	•
	ø50	•	•	•	•	•	•	•	•	•

Compact Guide Cylinder Variations

Series	Bearing	Bore size [mm]						Cushion	Piping	Stroke [mm]
		12	16	20	25	32	40			
 Basic type	Slide bearing	•	•	•	•	•	•	Rubber	· Top/Side ported · Top ported (ø12 and ø16 only)	ø12, ø16: 10 to 150 ø20, ø25: 20 to 200 ø32 to ø50: 25 to 200
	Ball bushing		•			•				
 With air cushion New	Slide bearing	•	•	•	•	•	•	Air cushion		ø12, ø16: 25 to 150 ø25 to ø50: 25 to 200

CONTENTS

Basic Type

How to Order p. 3
 Specifications p. 4
 Weight p. 5
 Replacement Parts p. 7
 Dimensions p. 8
 Model Selection p. 10

With Air Cushion

How to Order p. 23-1
 Specifications p. 23-2
 Weight p. 23-3
 Replacement Parts p. 23-5
 Dimensions p. 23-6
 Model Selection p. 23-8

Auto Switch Mounting p. 24

Compact Guide Cylinder

MGPK Series

∅12, ∅16, ∅20, ∅25, ∅32, ∅40, ∅50

RoHS

How to Order

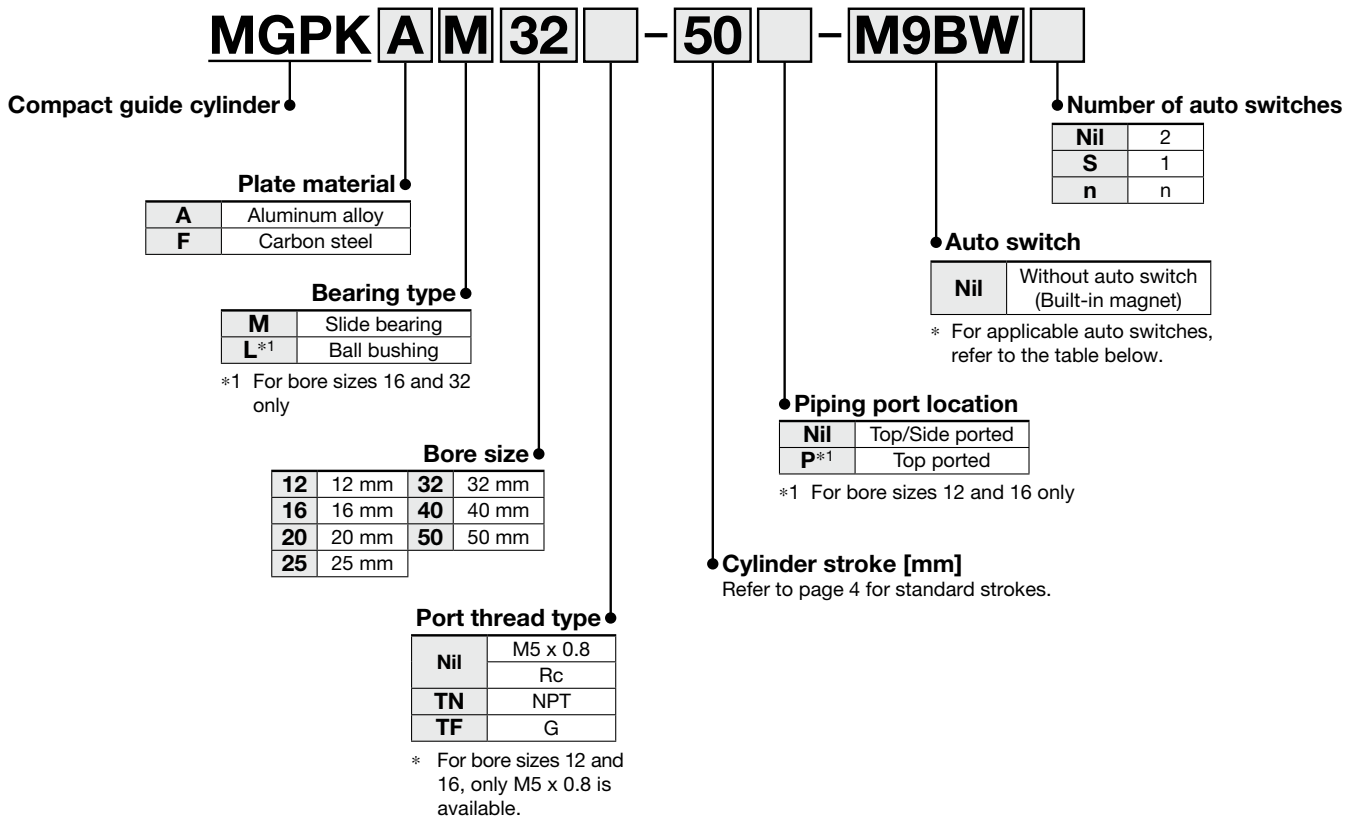

Applicable Auto Switches / Refer to the **Web Catalog** for further information on auto switches.

Type	Special function	Electrical entry	Indicator/light	Wiring (Output)	Load voltage		Auto switch model		Lead wire length [m]				Pre-wired connector	Applicable load					
					DC	AC	Perpendicular	In-line	0.5 (Nil)	1 (M)	3 (L)	5 (Z)							
Solid state auto switch	—	Grommet	Yes	3-wire (NPN)	24 V	5 V, 12 V	—	M9NV	M9N	●	●	●	○	○	IC circuit	Relay, PLC			
				3-wire (PNP)				M9PV	M9P	●	●	●	○	○					
				2-wire				M9BV	M9B	●	●	●	○	○					
	Diagnostic indication (2-color indicator)			3-wire (NPN)	5 V, 12 V	—	M9N WV	M9NW	●	●	●	○	○	○	○		IC circuit		
				3-wire (PNP)			M9P WV	M9PW	●	●	●	○	○						
				2-wire			M9B WV	M9BW	●	●	●	○	○						
	Water resistant (2-color indicator)			3-wire (NPN)	5 V, 12 V	—	M9NAV*1	M9NA*1	○	○	●	○	○	○	○		IC circuit		
				3-wire (PNP)			M9PAV*1	M9PA*1	○	○	●	○	○						
				2-wire			M9BAV*1	M9BA*1	○	○	●	○	○						
Reed auto switch	—	Grommet	Yes	3-wire (NPN equivalent)	24 V	5 V	—	A96V	A96	●	—	●	—	—	IC circuit	—			
				2-wire				100 V	A93V*2	A93	●	●	●	●			—	—	Relay, PLC
								100 V or less	A90V	A90	●	—	●	—			—	—	

*1 Water-resistant type auto switches can be mounted on the above models, but SMC cannot guarantee water resistance.

*2 The 1 m lead wire is only applicable to the D-A93.

* Lead wire length symbols: 0.5 m.....Nil (Example) M9NW
 1 m.....M (Example) M9NWM
 3 m.....L (Example) M9NWL
 5 m.....Z (Example) M9NWX

* Solid state auto switches marked with a "○" are produced upon receipt of order.

* For details on auto switches with pre-wired connectors, refer to the **Web Catalog**.

* Auto switches are shipped together with the product but do not come assembled.



Specifications

Bore size [mm]	ø12	ø16	ø20	ø25	ø32	ø40	ø50
Action	Double acting						
Fluid	Air						
Proof pressure	1.5 MPa						
Max. operating pressure	1.0 MPa						
Min. operating pressure	0.12 MPa	0.1 MPa					
Ambient and fluid temperatures	-10 to 60°C (No freezing)						
Piston speed*¹	50 to 500 mm/s						
Cushion	Rubber bumper on both ends						
Lubrication	Not required (Non-lube)						
Stroke length tolerance	0 to $^{+1.5}_0$ mm* ²						

*1 Speed with no load. Depending on the operating conditions, the piston speed may not be satisfied.

*2 Stroke length tolerance does not include the amount of bumper change.

Standard Strokes

Bore size [mm]	Standard stroke [mm]
12, 16	10, 20, 30, 40, 50, 75, 100, 125, 150
20, 25	20, 30, 40, 50, 75, 100, 125, 150, 175, 200
32 to 50	25, 50, 75, 100, 125, 150, 175, 200

Symbol

Rubber bumper

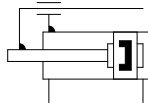

Refer to page 24 for cylinders with auto switches.

- Auto Switch Proper Mounting Position (Detection at stroke end) and Mounting Height
- Minimum Stroke for Auto Switch Mounting
- Operating Range
- Auto Switch Mounting

Manufacturing of Intermediate Strokes

Description	Spacer installation type Spacers are installed in the standard stroke cylinder. · ø12 to ø32: Stroke can be modified in 1 mm increments. · ø40, ø50: Stroke can be modified in 5 mm increments.	
Part no.	Refer to the "How to Order" for the standard model numbers.	
Applicable stroke [mm]	ø12, ø16	1 to 149
	ø20, ø25, ø32	1 to 199
	ø40, ø50	5 to 195
Example	Part no.: MGPKAM16-39 A 1 mm spacer is installed in MGPKAM16-40. Dimension C is 68.5 mm.	

Theoretical Output

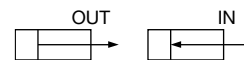

[N]

Bore size [mm]	Rod size [mm]	Operating direction	Piston area [mm ²]	Operating pressure [MPa]									
				0.2	0.3	0.4	0.5	0.6	0.7	0.8	0.9	1.0	
12	6	OUT	113	23	34	45	57	68	79	90	102	113	
		IN	85	17	25	34	42	51	59	68	76	85	
16	8	OUT	201	40	60	80	101	121	141	161	181	201	
		IN	151	30	45	60	75	90	106	121	136	151	
20	10	OUT	314	63	94	126	157	188	220	251	283	314	
		IN	236	47	71	94	118	141	165	188	212	236	
25	10	OUT	491	98	147	196	245	295	344	393	442	491	
		IN	412	82	124	165	206	247	289	330	371	412	
32	14	OUT	804	161	241	322	402	483	563	643	724	804	
		IN	650	130	195	260	325	390	455	520	585	650	
40	16	OUT	1257	251	377	503	628	754	880	1005	1131	1257	
		IN	1056	211	317	422	528	634	739	845	950	1056	
50	20	OUT	1963	393	589	785	982	1178	1374	1571	1767	1963	
		IN	1649	330	495	660	825	990	1154	1319	1484	1649	

* Theoretical output [N] = Pressure [MPa] x Piston area [mm²]

MGPK Series

Weight

MGPK□M12 to 50

[kg]

Bore size [mm]	Plate material	Standard stroke [mm]											
		10	20	25	30	40	50	75	100	125	150	175	200
12	Carbon steel	0.18	0.22	—	0.25	0.28	0.32	0.42	0.50	0.60	0.69	—	—
	Aluminum alloy	0.15	0.18	—	0.22	0.25	0.28	0.38	0.47	0.57	0.65	—	—
16	Carbon steel	0.23	0.27	—	0.31	0.35	0.39	0.51	0.61	0.74	0.83	—	—
	Aluminum alloy	0.19	0.23	—	0.27	0.31	0.35	0.46	0.56	0.69	0.79	—	—
20	Carbon steel	—	0.49	—	0.55	0.61	0.67	0.86	1.01	1.17	1.32	1.47	1.62
	Aluminum alloy	—	0.41	—	0.47	0.53	0.59	0.78	0.93	1.09	1.24	1.39	1.54
25	Carbon steel	—	0.69	—	0.77	0.85	0.93	1.21	1.41	1.63	1.83	2.03	2.23
	Aluminum alloy	—	0.57	—	0.65	0.73	0.81	1.08	1.28	1.50	1.70	1.90	2.10
32	Carbon steel	—	—	1.07	—	—	1.33	1.66	1.92	2.21	2.48	2.75	3.01
	Aluminum alloy	—	—	0.87	—	—	1.14	1.46	1.73	2.01	2.28	2.55	2.81
40	Carbon steel	—	—	1.37	—	—	1.68	2.04	2.35	2.66	2.97	3.27	3.58
	Aluminum alloy	—	—	1.14	—	—	1.45	1.81	2.12	2.43	2.73	3.04	3.35
50	Carbon steel	—	—	2.35	—	—	2.82	3.38	3.85	4.32	4.78	5.25	5.72
	Aluminum alloy	—	—	1.86	—	—	2.33	2.89	3.36	3.82	4.29	4.76	5.22

MGPK□L16, 32

[kg]

Bore size [mm]	Plate material	Standard stroke [mm]											
		10	20	25	30	40	50	75	100	125	150	175	200
16	Carbon steel	0.25	0.29	—	0.33	0.39	0.43	0.53	0.63	0.76	0.86	—	—
	Aluminum alloy	0.20	0.24	—	0.28	0.34	0.38	0.48	0.58	0.72	0.82	—	—
32	Carbon steel	—	—	1.14	—	—	1.41	1.74	2.01	2.43	2.69	2.96	3.23
	Aluminum alloy	—	—	0.94	—	—	1.21	1.54	1.81	2.23	2.49	2.76	3.03

Allowable Rotational Torque of Plate

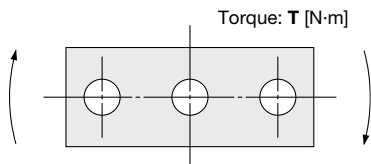

MGPK□M12 to 50

[N·m]

Bore size [mm]	Standard stroke [mm]											
	10	20	25	30	40	50	75	100	125	150	175	200
12	0.39	0.32	—	0.27	0.24	0.21	0.43	0.36	0.31	0.27	—	—
16	0.69	0.58	—	0.49	0.43	0.38	0.69	0.58	0.5	0.44	—	—
20	—	1.05	—	0.93	0.83	0.75	1.88	1.63	1.44	1.28	1.16	1.06
25	—	1.76	—	1.55	1.38	1.25	2.96	2.57	2.26	2.02	1.83	1.67
32	—	—	6.35	—	—	5.13	5.69	4.97	4.42	3.98	3.61	3.31
40	—	—	7.00	—	—	5.66	6.27	5.48	4.87	4.38	3.98	3.65
50	—	—	13.00	—	—	10.8	12.00	10.6	9.50	8.60	7.86	7.24

MGPK□L16, 32

[N·m]

Bore size [mm]	Standard stroke [mm]											
	10	20	25	30	40	50	75	100	125	150	175	200
16	0.99	0.74	—	0.59	0.99	0.86	0.65	0.52	0.43	0.37	0.32	0.28
32	—	—	5.95	—	—	4.89	5.11	4.51	6.34	5.79	5.33	4.93

Non-rotating Accuracy of Plate

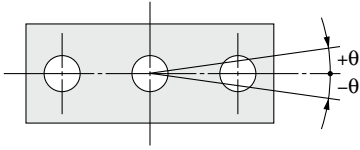

Non-rotating accuracy θ when retracted and when no load is applied should be not more than the values shown in the table.

Bore size [mm]	Non-rotating accuracy θ	
	MGPK□M	MGPK□L
12	$\pm 0.07^\circ$	—
16		$\pm 0.05^\circ$
20	$\pm 0.06^\circ$	—
25		—
32	$\pm 0.05^\circ$	$\pm 0.03^\circ$
40		—
50	$\pm 0.04^\circ$	—

Allowable Kinetic Energy

⚠ Caution

The load mass and a max. speed must be within the ranges shown below.

* Refer to "Model Selection" on page 10 for the selection method.

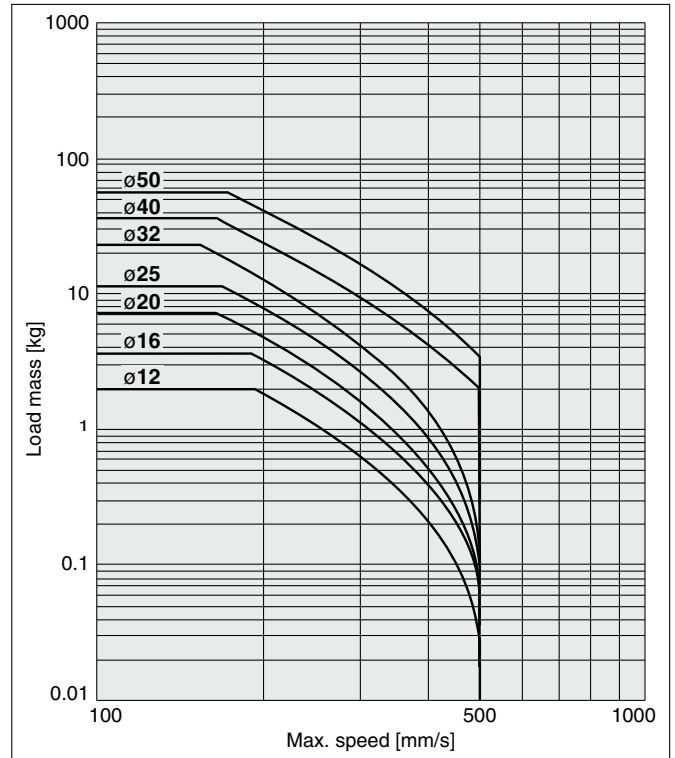

MGPK Series

Replacement Parts: MGPK□M, MGPK□L Common

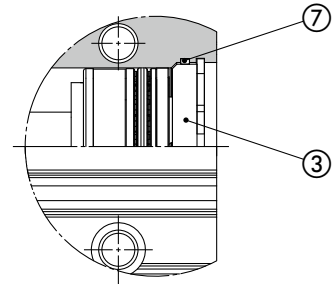
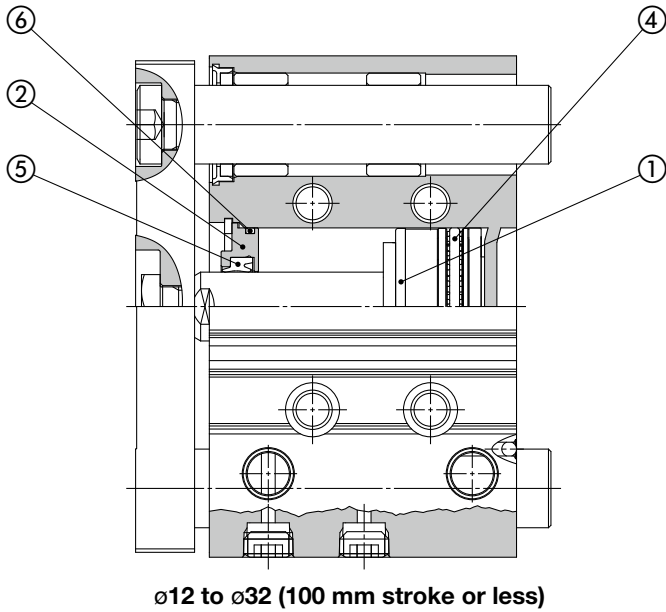

ø12 to ø32 (101 mm stroke or more)
ø40, ø50

Component Parts

No.	Description
1	Piston
2	Collar
3	Head cover
4	Piston seal
5	Rod seal
6	Gasket A
7	Gasket B

Replacement Parts: Seal Kit

Bore size [mm]	Kit no.	Contents
12	MGPK12-PS	Set of nos. ④, ⑤, ⑥, ⑦
16	MGPK16-PS	
20	MGPK20-PS	
25	MGPK25-PS	
32	MGPK32-PS	
40	MGPK40-PS	
50	MGPK50-PS	

* The seal kit includes ④ to ⑦. Order the seal kit based on each bore size.

* The seal kit does not include a grease pack. Order it separately.

Grease pack part number: GR-S-010 (10 g)

Dimensions: $\varnothing 12$ to $\varnothing 25$

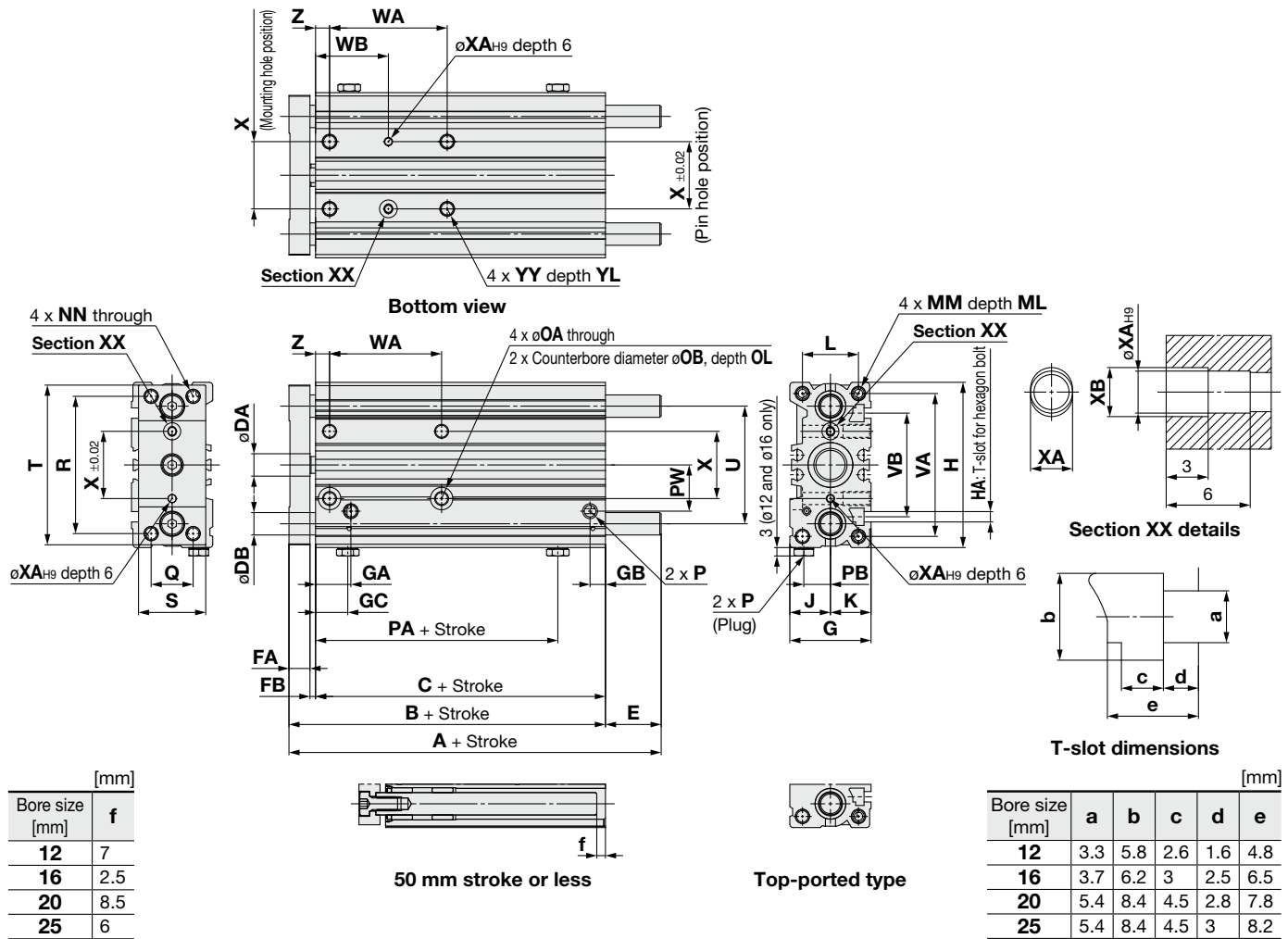

- * The use of a slot (width XA, length XB, depth 3) allows for a relaxed pin pitch tolerance, with the pin hole ($\varnothing XA_{H9}$, depth 6) as the reference, without affecting mounting accuracy.
- * For intermediate strokes other than standard strokes, refer to the "Manufacturing of Intermediate Strokes" on page 4.
- * For bore sizes $\varnothing 12$ and $\varnothing 16$, only M5 x 0.8 port is available.
- * For bore size $\varnothing 20$ or more, choice of Rc, NPT, G port is available. (Refer to page 3.)

MGPK□M, MGPK□L

Bore size [mm]	Standard stroke	A			B		C		DA	DB	E			FA	FB
		50 st or less	Over 50 st 100 st or less	Over 100 st	100 st or less	Over 100 st	100 st or less	Over 100 st			50 st or less	Over 50 st 100 st or less	Over 100 st		
12	10, 20, 30, 40, 50	36.5	53	75	36.5	39	27.5	30	6	8	0	16.5	36	7	2
16	75, 100, 125, 150	38	58	86	38	41	28.5	31.5	8	8	0	20	45	7.5	2
20	20, 30, 40, 50, 75, 100	50.5	75.5		50.5	52.5	39	41	10	10	0	25	23	9	2.5
25	125, 150, 175, 200	50.5	77		50.5	53.5	37.5	40.5	10	14	0	26.5	23.5	10	3

Bore size [mm]	G	GA	GB		GC	H	HA	J	K	L	MM	ML	NN	OA	OB	OL	P			PA	PB	PW	Q
			100 st or less	Over 100 st													Nil	TN	TF				
12	25	10	6	7	10	54	M5	12.5	12.5	17	M4 x 0.7	10	M4 x 0.7	4.3	8	4.5	M5 x 0.8			11.5	8	16	14
16	29	12.5	5.5	7.5	11.5	59	M3.5	14.5	14.5	20	M5 x 0.8	11	M5 x 0.8	4.3	8	4.5	M5 x 0.8			11.5	9.5	16.5	15
20	33	12.5	9.5	9.5	12.5	78	M5	16.5	16.5	23	M5 x 0.8	13	M5 x 0.8	5.4	9.5	5.5	Rc1/8	NPT1/8	G1/8	15.5	8.5	25	18
25	38	11.5	9.5	12.5	11.5	90	M5	19	19	27	M6 x 1	15	M6 x 1	5.4	9.5	7	Rc1/8	NPT1/8	G1/8	12.5	11	30	22

Bore size [mm]	R	S	T	U	VA	VB	WA				WB				X	XA	XB	YY	YL	Z				
							10 st or less	Over 10 st 30 st or less	Over 30 st 100 st or less	Over 100 st	10 st or less	Over 10 st 30 st or less	Over 30 st 100 st or less	Over 100 st										
12	43	22	50	37	47	33	20				15				20	3	3.5	M5 x 0.8	10	5				
16	49	24	57	42	51	37	20		22		42		110		15	16	26	60	24	3	3.5	M5 x 0.8	10	5
20	60	28.5	71	49	66	44	24		44		120		30		40	78	28	3	3.5	M6 x 1	12	18	18	
25	73	34	86	60	78	50	24		44		12		29		39	77	34	4	4.5	M6 x 1	12	17	17	

MGPK□L: A, DB, and E Dimensions [mm]

Bore size [mm]	A			DB	E		
	30 st or less	Over 30 st 100 st or less	Over 100 st		30 st or less	Over 30 st 100 st or less	Over 100 st
16	43.5	61.5	91	8	5.5	23.5	50

MGPK Series

Dimensions: $\varnothing 32$ to $\varnothing 50$

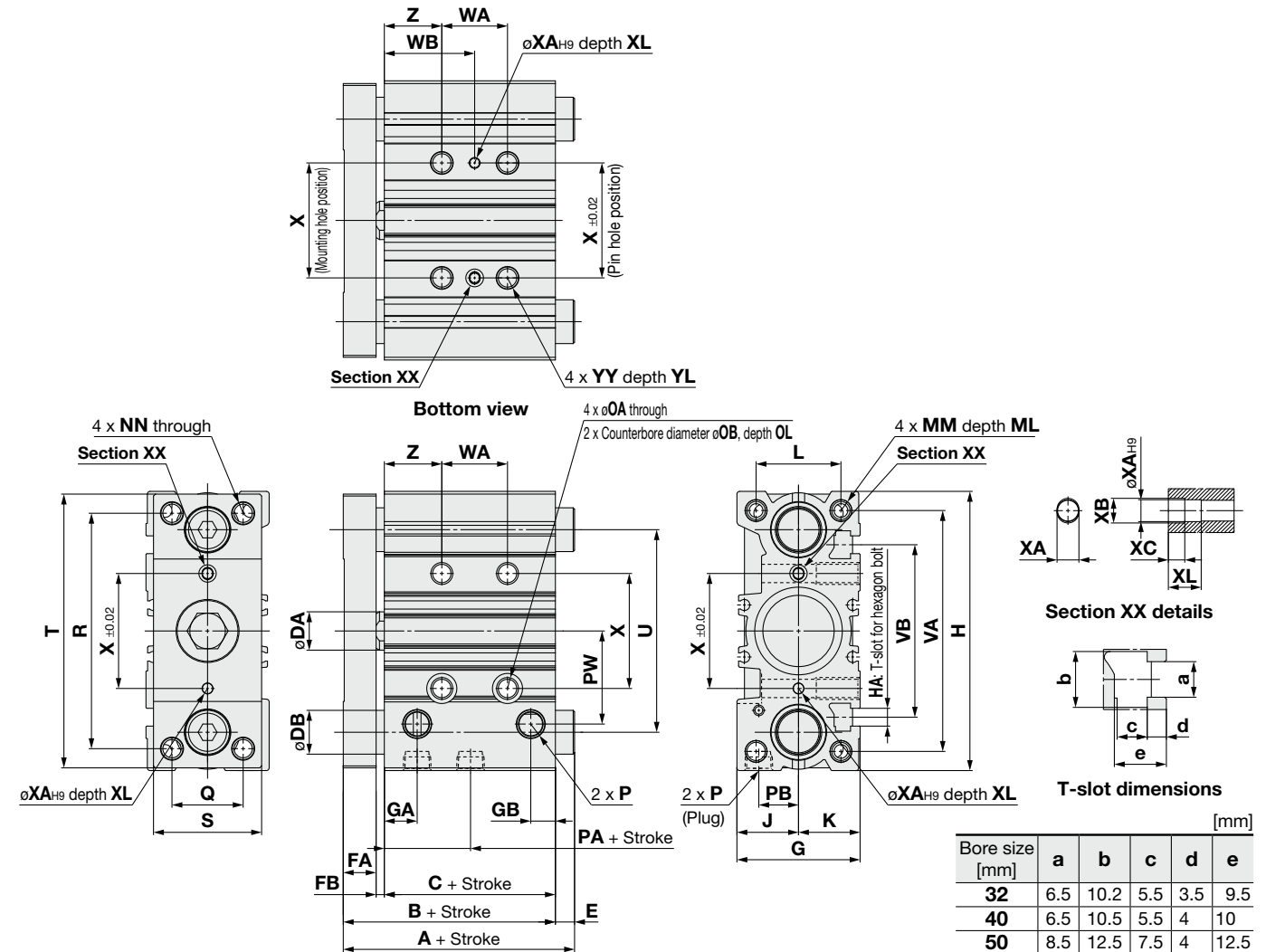

- * The use of a slot (width XA, length XB, depth XC) allows for a relaxed pin pitch tolerance, with the pin hole ($\varnothing XA_{H9}$, depth XL) as the reference, without affecting mounting accuracy.
- * For intermediate strokes other than standard strokes, refer to the "Manufacturing of Intermediate Strokes" on page 4.
- * Choice of Rc, NPT, G port is available. (Refer to page 3.)

MGPK□M, MGPK□L

Bore size [mm]	Standard stroke	A		B		C		DA	DB	E			FA	FB	G	GA
		50 st or less	Over 50 st	100 st or less	Over 100 st	100 st or less	Over 100 st			50 st or less	Over 50 st or less	Over 100 st				
32	25, 50, 75, 100, 125, 150, 175, 200	60	78	52.5	55	37.5	40	14	16	7.5	25.5	23	12	3	45	12
40		69	87	64		47		16	16	5	23		12	5	49	15
50		79	100	69		48		20	20	10	31		16	5	59	15

Bore size [mm]	GB	H	HA	J	K	L	MM	ML	NN	OA	OB	OL	P			PA	PB	PW	Q	R	S	T	U	VA	VB
													Nil	TN	TF										
32	9	102	M6	22.5	22.5	31	M8 x 1.25	20	M8 x 1.25	6.7	11	9	Rc1/8	NPT1/8	G1/8	6.5	14.5	34	26	86	39.5	100	74	88	63
40	12	112	M6	24.5	24.5	35	M8 x 1.25	20	M8 x 1.25	6.7	11	9	Rc1/8	NPT1/8	G1/8	16	16.5	41	28	92	42	106	82	98	72
50	12	140	M8	29.5	29.5	43	M10 x 1.5	22	M10 x 1.5	8.6	14	9	Rc1/4	NPT1/4	G1/4	13	19	49	35	115	52.5	133	104	122	92

Bore size [mm]	WA			WB			X	XA	XB	XC	XL	YY	YL	Z
	25 st or less	Over 25 st or less	Over 100 st	25 st or less	Over 25 st or less	Over 100 st								
32	24	48	124	33	45	83	42	4	4.5	3	6	M8 x 1.25	16	21
40	24	48	124	34	46	84	50	4	4.5	3	6	M8 x 1.25	16	22
50	24	48	124	36	48	86	66	5	6	4	8	M10 x 1.5	20	24

MGPK□L: A, DB, and E Dimensions [mm]

Bore size [mm]	A			DB	E		
	50 st or less	Over 50 st or less	Over 100 st		50 st or less	Over 50 st or less	Over 100 st
32	68.5	81.5	109.5	16	16	29	54.5

MGPK Series Model Selection

Selection Conditions

Mounting orientation		Vertical		Horizontal	
Bearing type	Plate material	Max. speed [mm/s]			
		200 or less	400	200 or less	400
Slide bearing	Carbon steel	1, 2	3, 4	5, 6	7, 8
	Aluminum alloy	9, 10	11, 12	13, 14	15, 16
Ball bushing	Carbon steel	17 to 20	21 to 24	25, 26	27, 28
	Aluminum alloy	29 to 32	33 to 36	37, 38	39, 40

Selection Example 1 (Vertical Mounting)

Selection conditions

Mounting: Vertical
Stroke: 30 mm stroke
Max. speed: 200 mm/s
Load mass: 2 kg
Eccentric distance: 80 mm

Find the point of intersection for the load mass of 2 kg and the eccentric distance of 80 mm on graph **1**, based on vertical mounting, 30 mm stroke, and the speed of 200 mm/s.

→ The **MGPKFM16-30** should be selected.

1 50 mm stroke or less, V = 200 mm/s or less

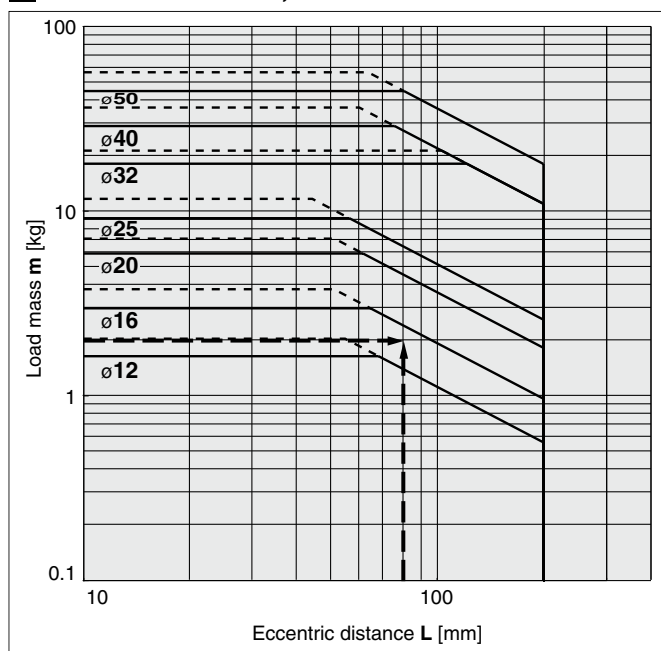

Selection Example 2 (Horizontal Mounting)

Selection conditions

Mounting: Horizontal
Distance between plate and load center of gravity: 50 mm
Max. speed: 200 mm/s
Load mass: 10 kg
Stroke: 25 mm stroke

Find the point of intersection for the load mass of 10 kg and 25 mm stroke on graph **5**, based on horizontal mounting, the distance of 50 mm between the plate and load center of gravity, and the speed of 200 mm/s.

→ The **MGPKFM32-25** should be selected.

5 L = 50 mm, V = 200 mm/s or less

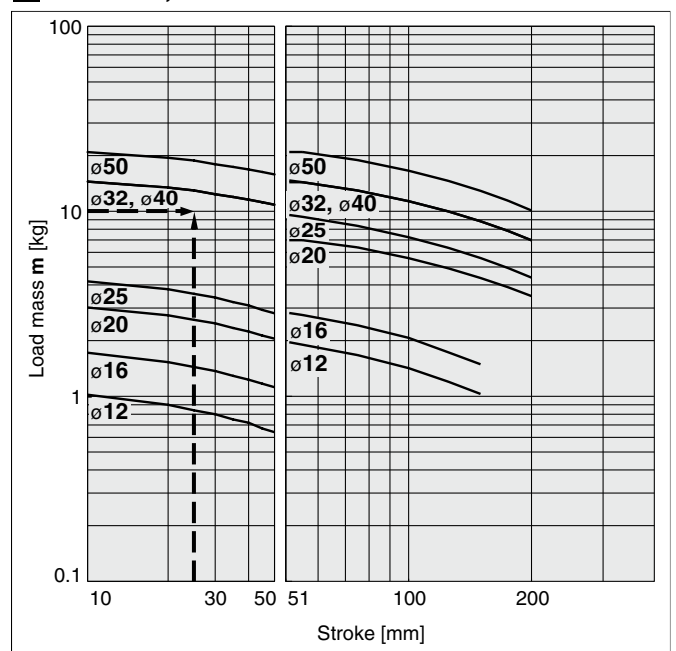

· When the max. speed exceeds 200 mm/s, the allowable load mass is determined by multiplying the value shown in the graph at 400 mm/s by the coefficient listed in the table below.

Max. speed	Up to 300 mm/s	Up to 400 mm/s	Up to 500 mm/s
Coefficient	1.7	1	0.6

MGPK Series

Vertical Mounting Plate Material **Carbon Steel /MGPK□M**

———— Operating pressure: 0.4 MPa - - - - - Operating pressure: 0.5 MPa or more

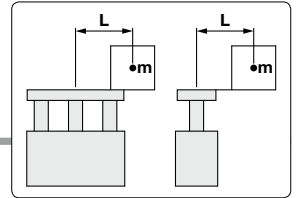

MGPKFM12 to 50

1 50 mm stroke or less, V = 200 mm/s or less

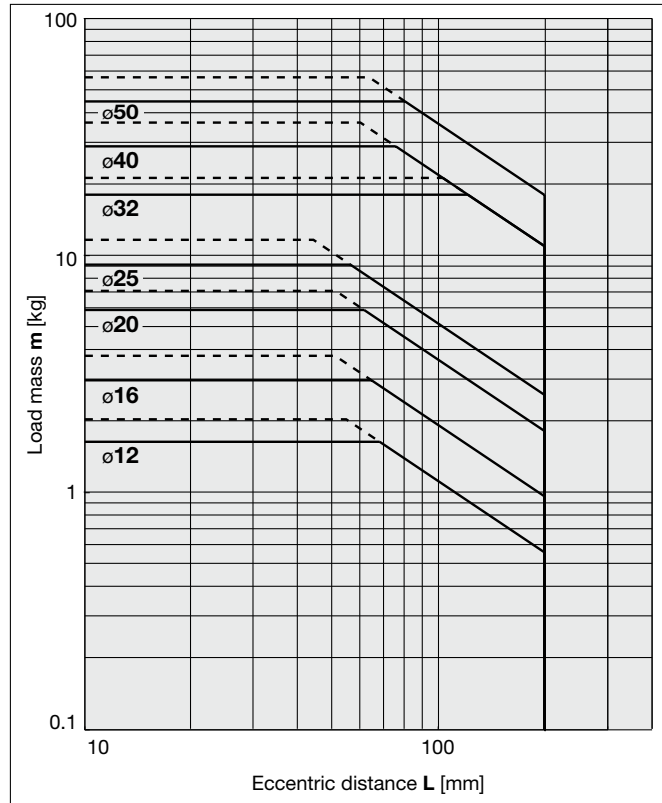

2 Over 50 mm stroke, V = 200 mm/s or less

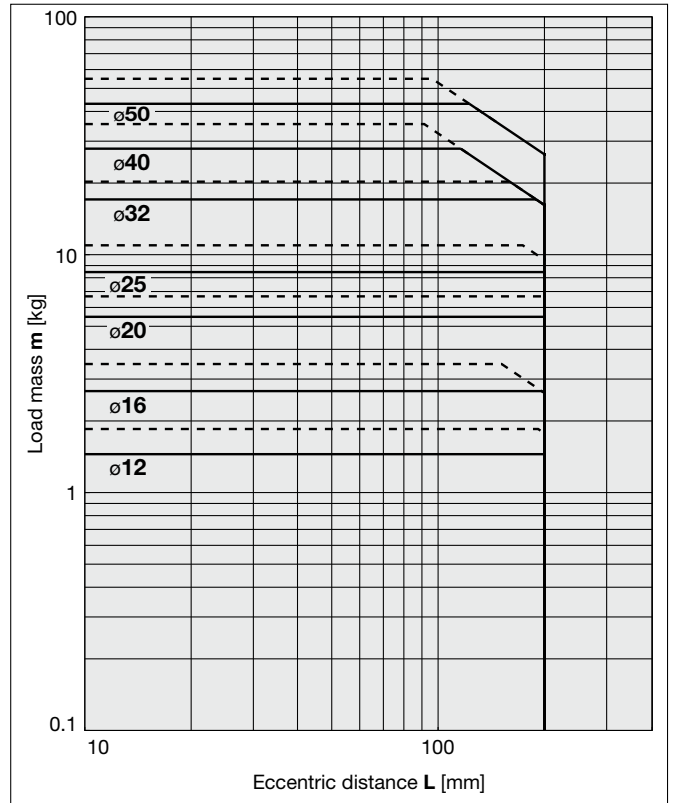

3 50 mm stroke or less, V = 400 mm/s

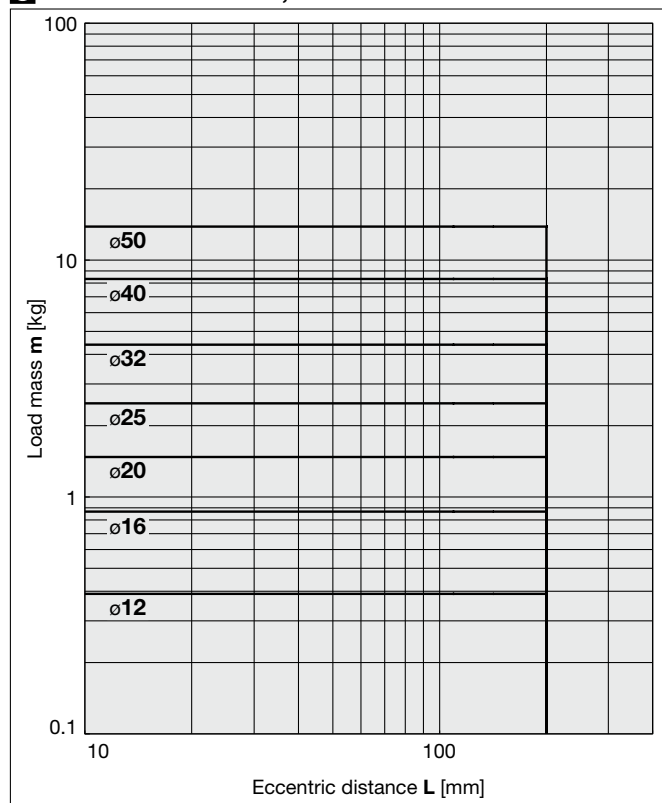

4 Over 50 mm stroke, V = 400 mm/s

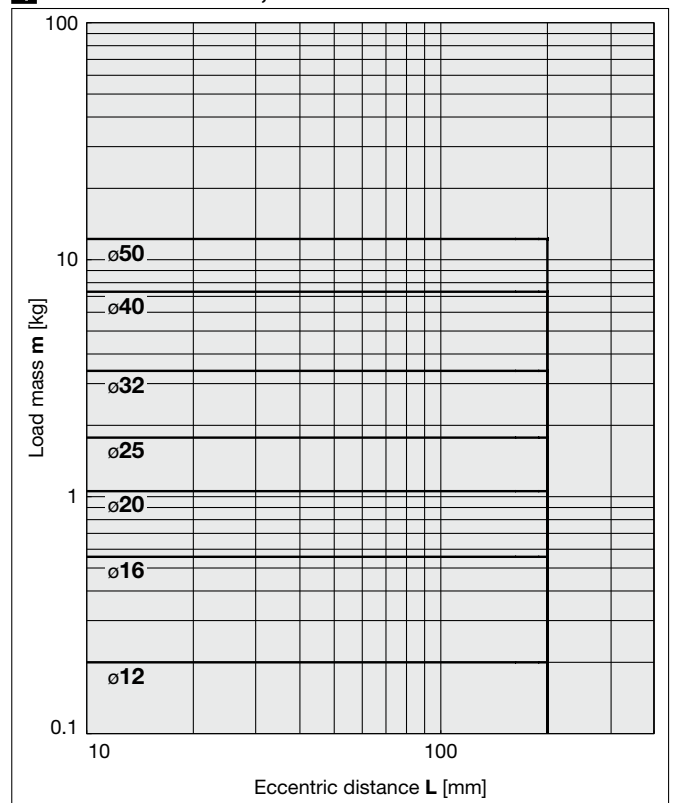

Horizontal Mounting

Plate Material **Carbon Steel /MGPK□M**

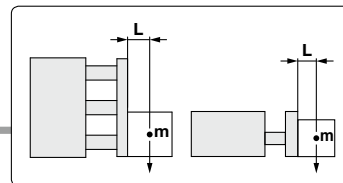

MGPKFM12 to 50

5 L = 50 mm, V = 200 mm/s or less

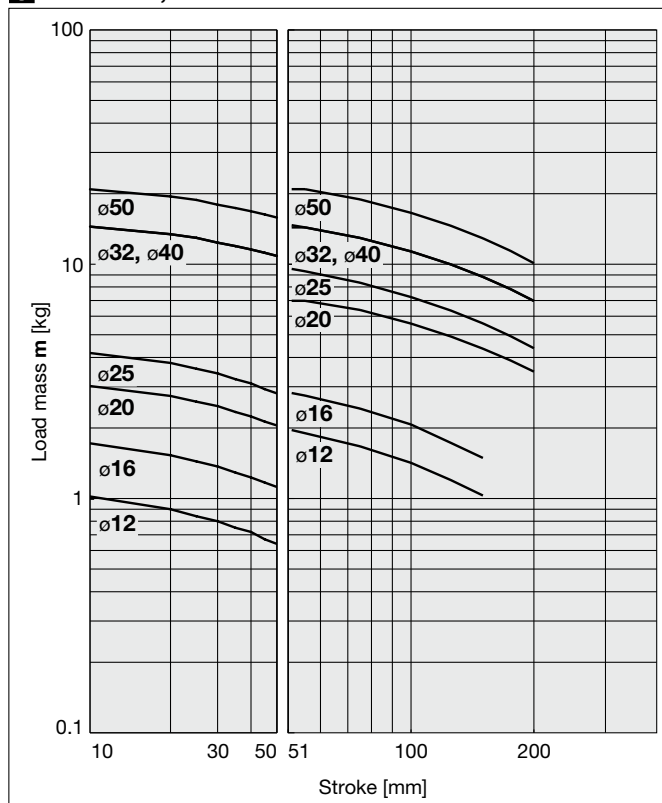

6 L = 100 mm, V = 200 mm/s or less

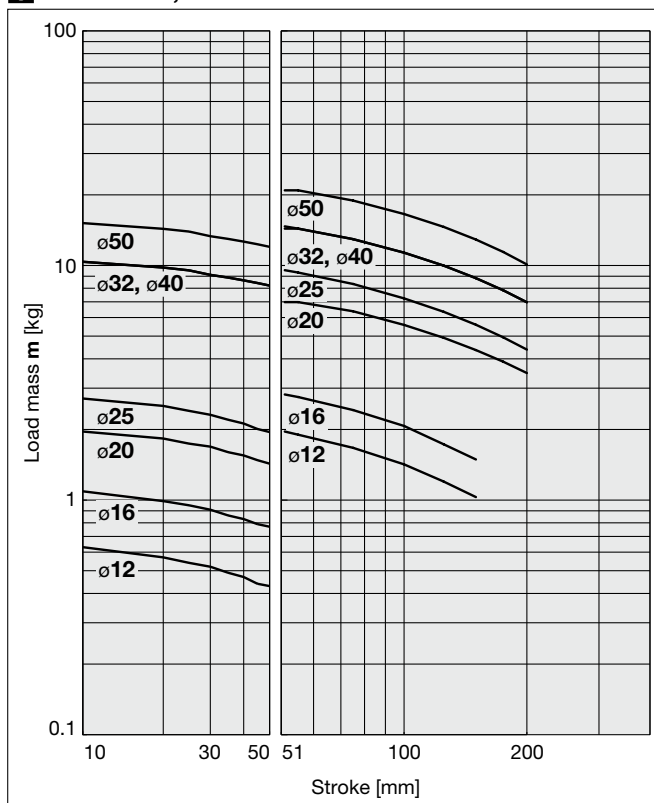

7 L = 50 mm, V = 400 mm/s

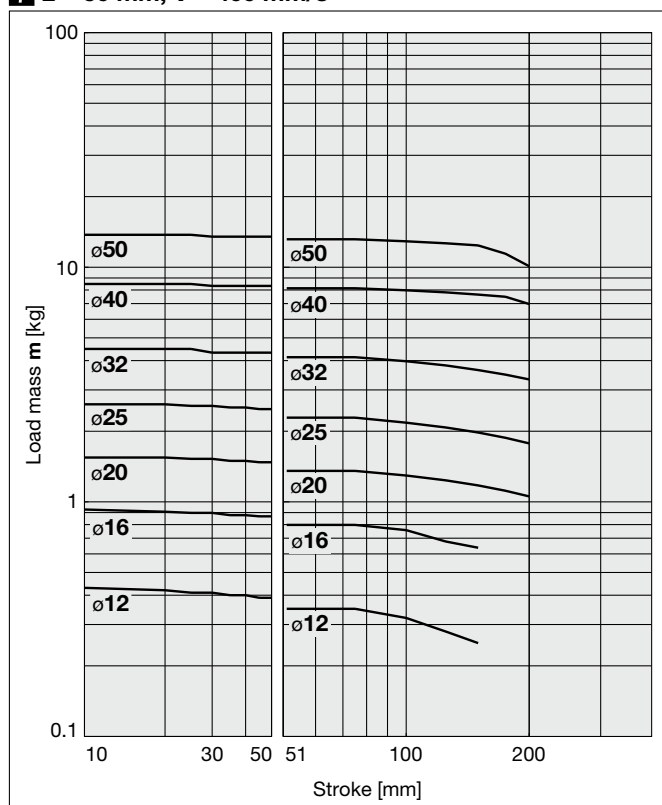

8 L = 100 mm, V = 400 mm/s

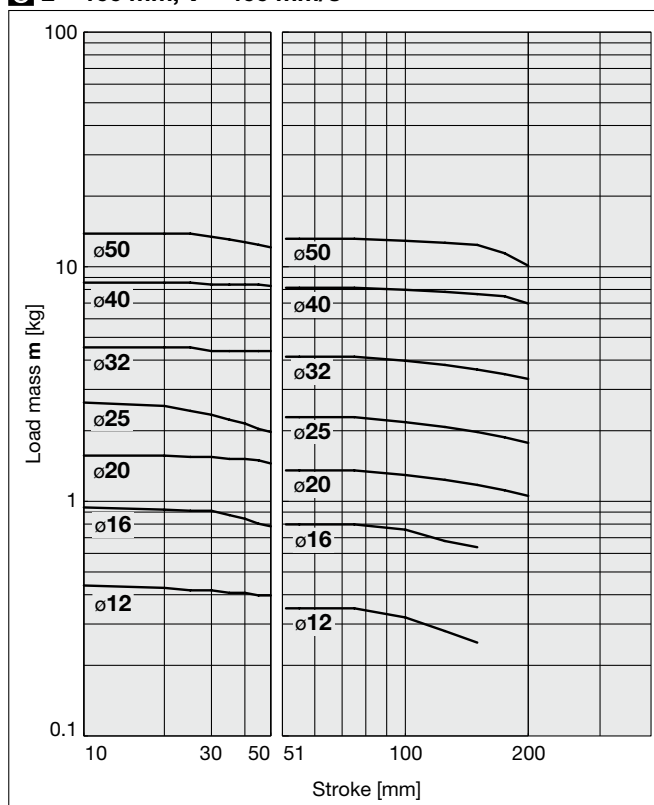

MGPK Series

Vertical Mounting Plate Material **Aluminum Alloy** /MGPK□M

———— Operating pressure: 0.4 MPa - - - - - Operating pressure: 0.5 MPa or more

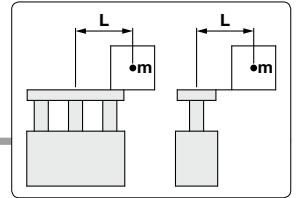

MGPKAM12 to 50

9 50 mm stroke or less, V = 200 mm/s or less

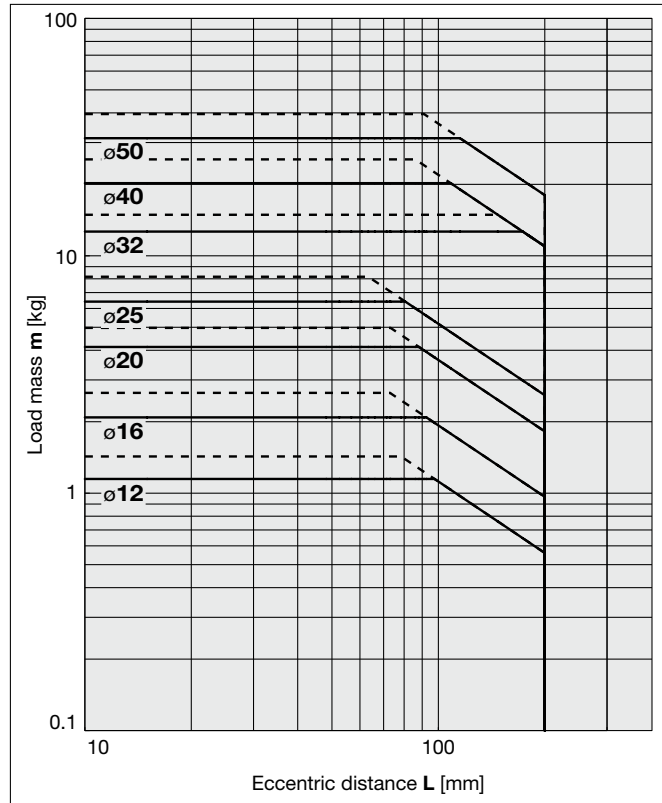

10 Over 50 mm stroke, V = 200 mm/s or less

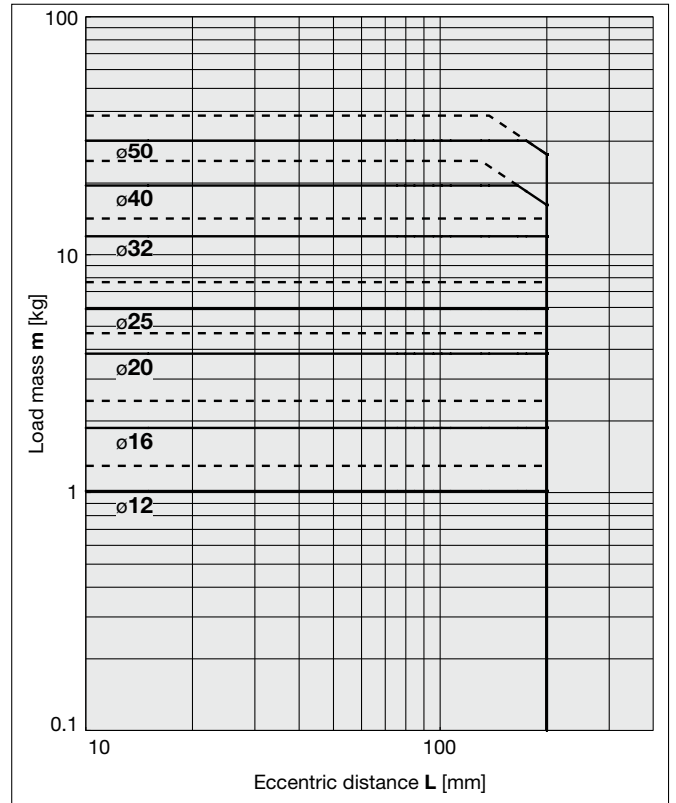

11 50 mm stroke or less, V = 400 mm/s

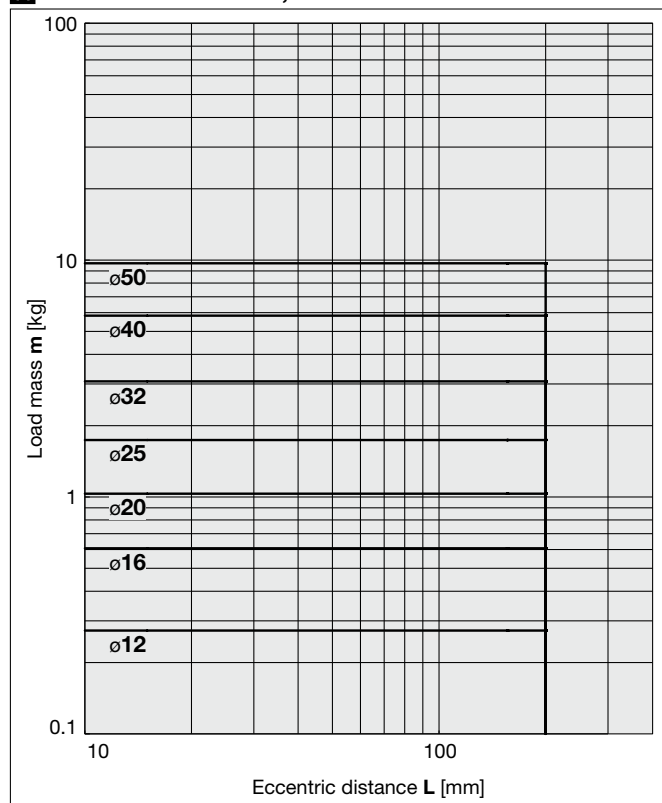

12 Over 50 mm stroke, V = 400 mm/s

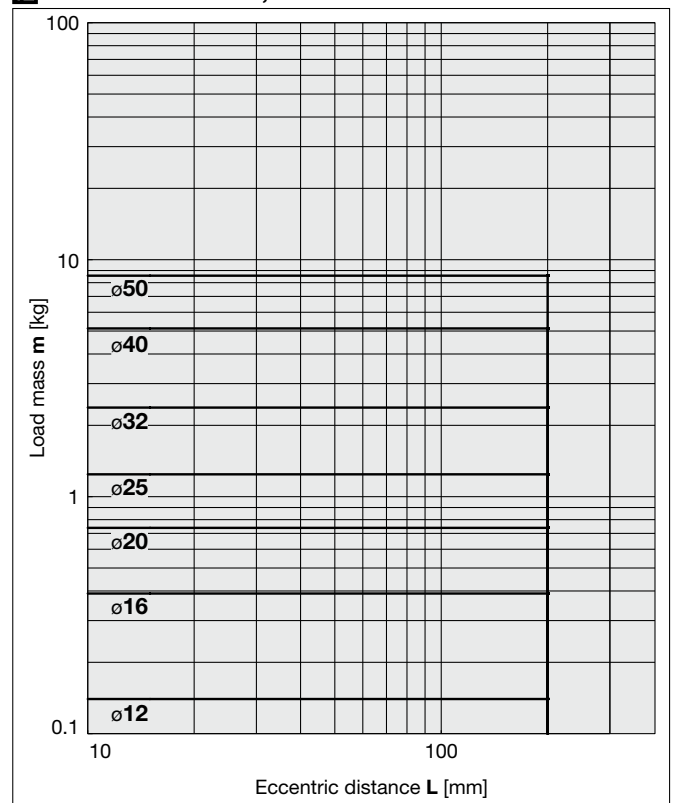

Horizontal Mounting **Plate Material Aluminum Alloy /MGPK□M**

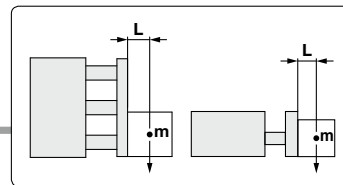

MGPKAM12 to 50

13 L = 50 mm, V = 200 mm/s or less

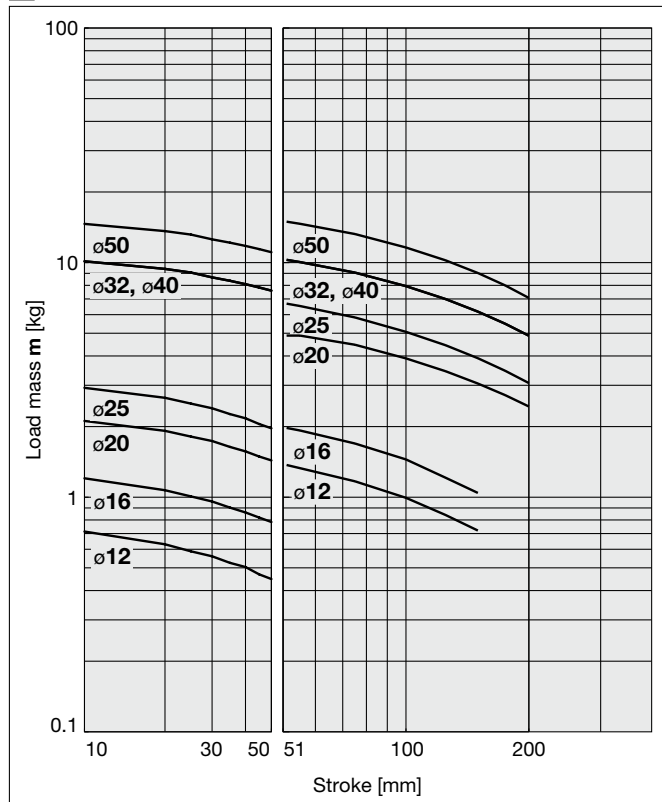

14 L = 100 mm, V = 200 mm/s or less

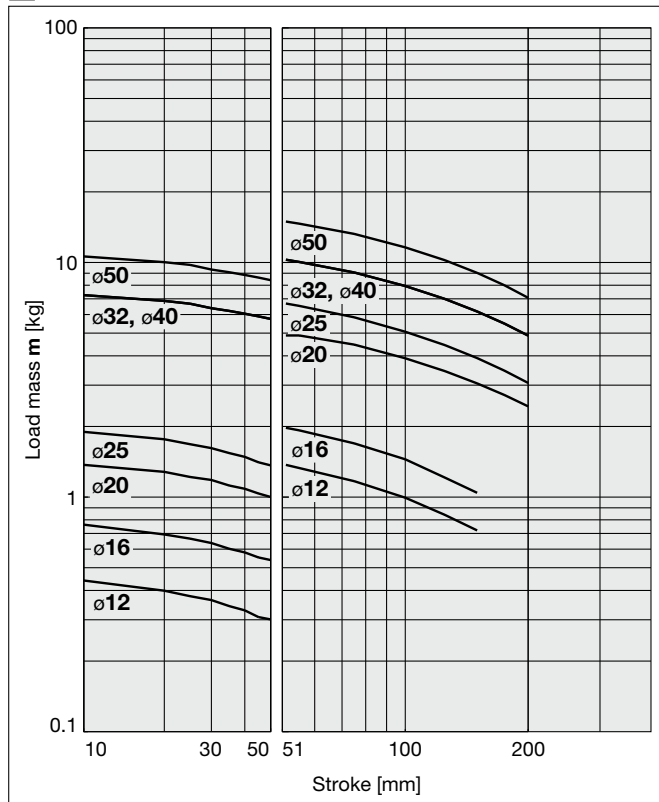

15 L = 50 mm, V = 400 mm/s

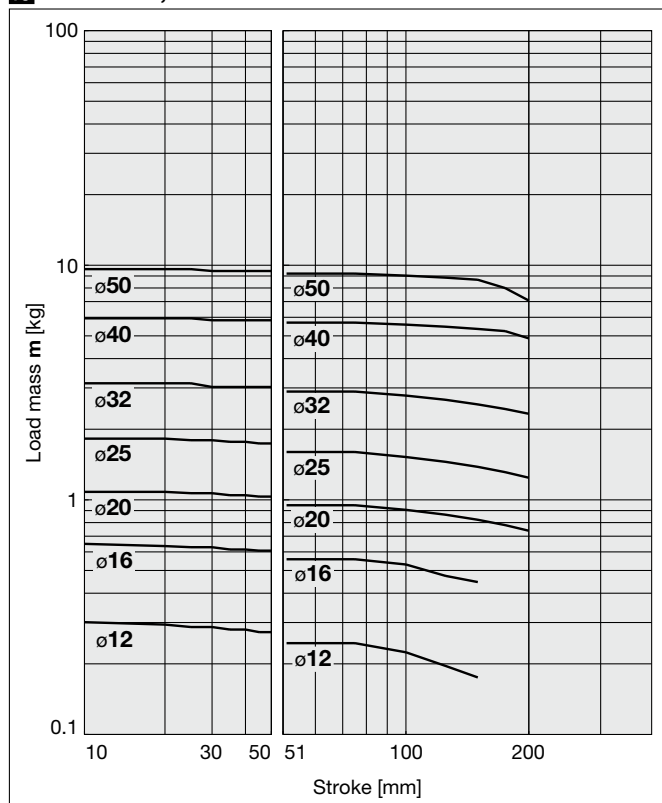

16 L = 100 mm, V = 400 mm/s

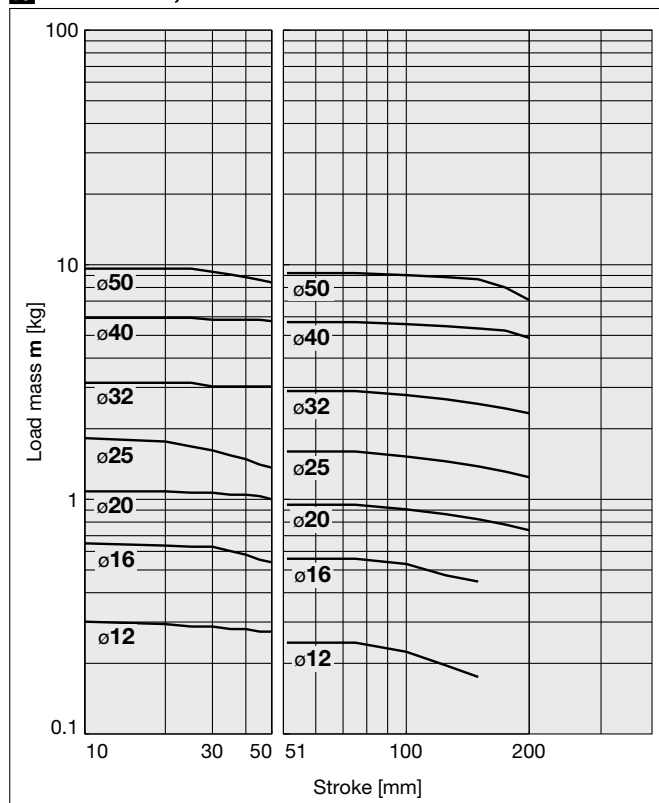

MGPK Series

Vertical Mounting Plate Material **Carbon Steel** /MGPK□L

—— Operating pressure: 0.4 MPa - - - - - Operating pressure: 0.5 MPa or more

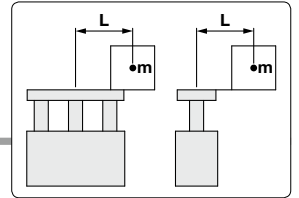

MGPKL16

17 30 mm stroke or less, V = 200 mm/s or less

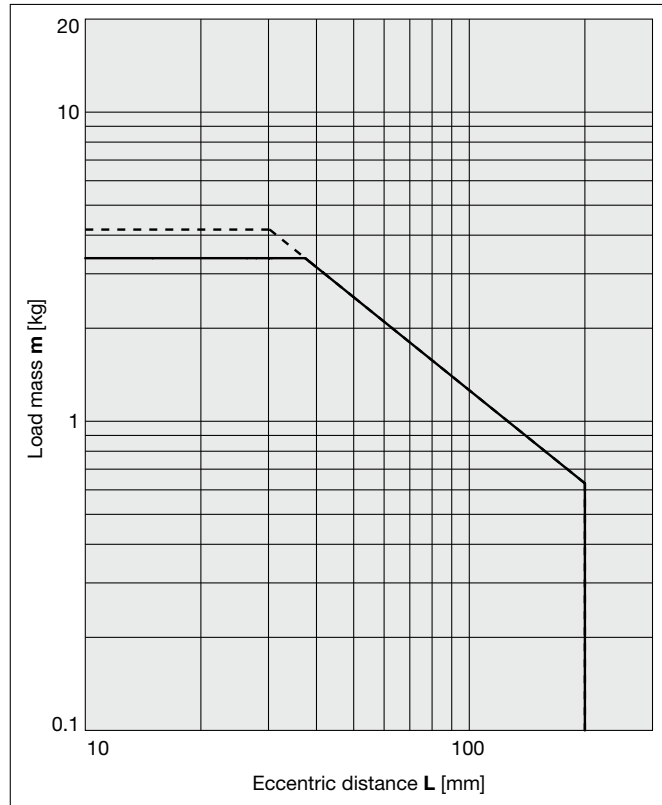

18 Over 30 mm stroke, V = 200 mm/s or less

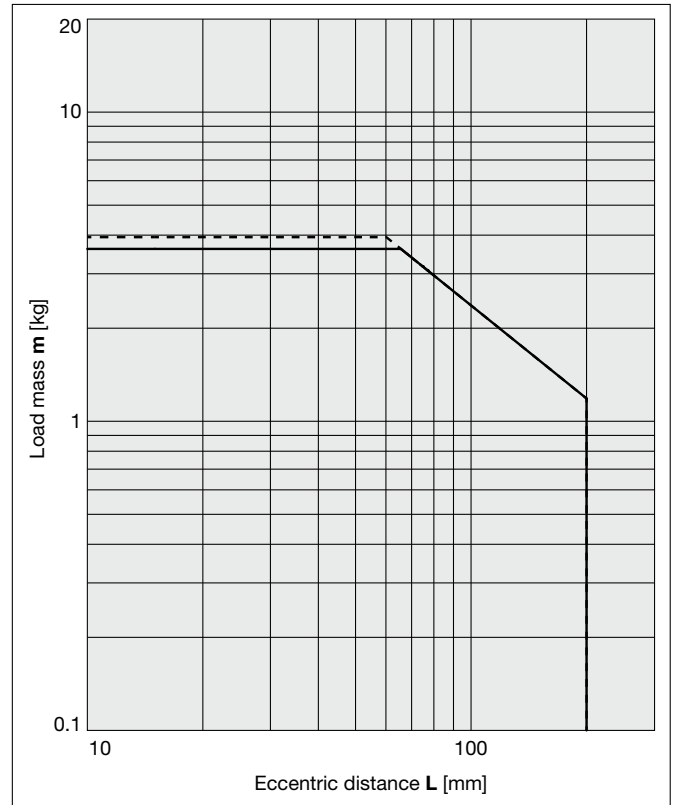

MGPKL32

19 50 mm stroke or less, V = 200 mm/s or less

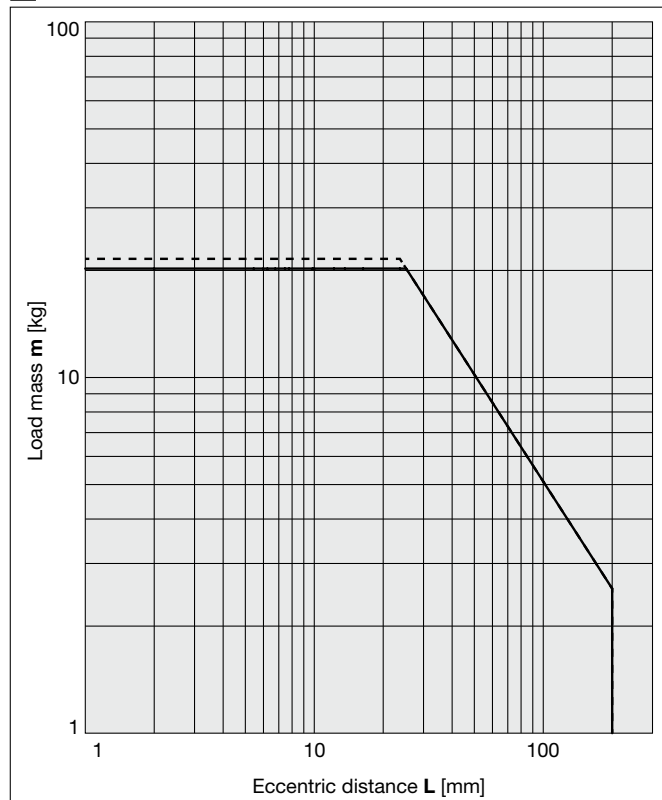

20 Over 50 mm stroke, V = 200 mm/s or less

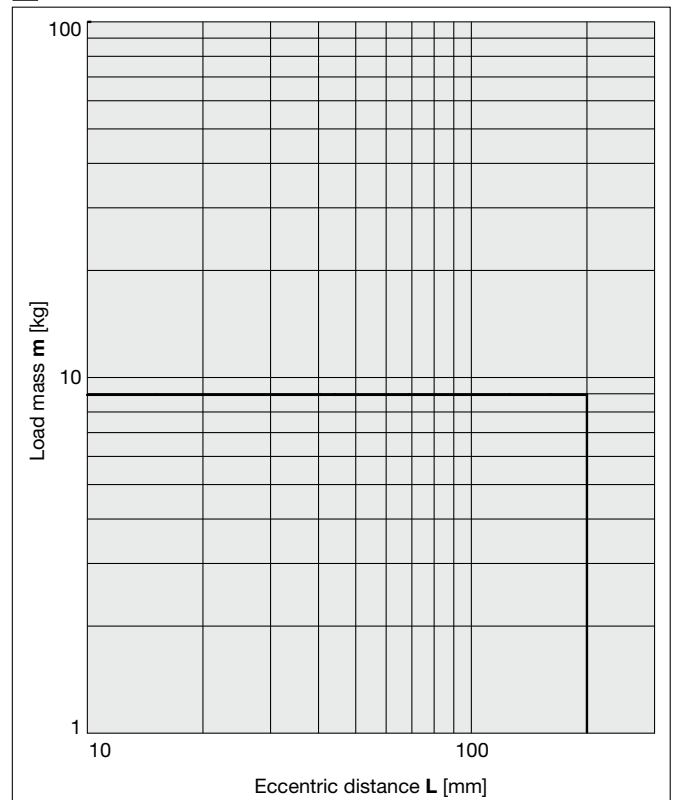

Vertical Mounting

Plate Material **Carbon Steel /MGPK□L**

—— Operating pressure: 0.4 MPa - - - - - Operating pressure: 0.5 MPa or more

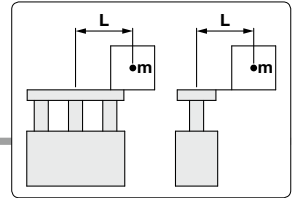

MGPKL16

21 30 mm stroke or less, V = 400 mm/s

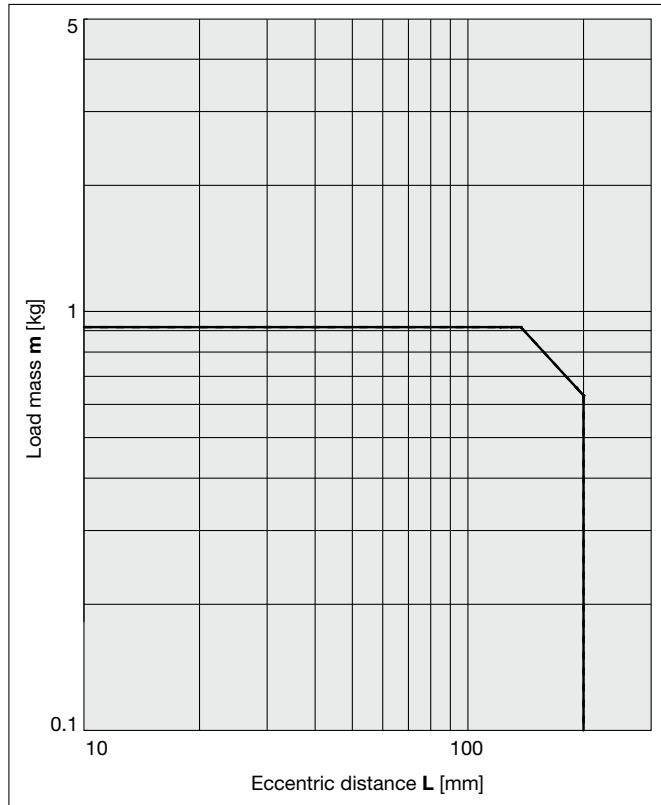

22 Over 30 mm stroke, V = 400 mm/s

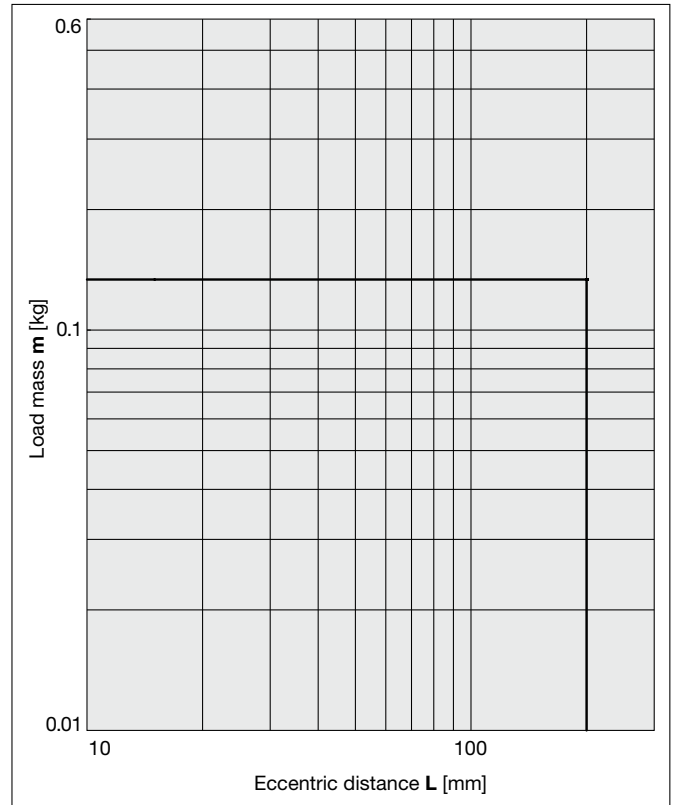

MGPKL32

23 50 mm stroke or less, V = 400 mm/s

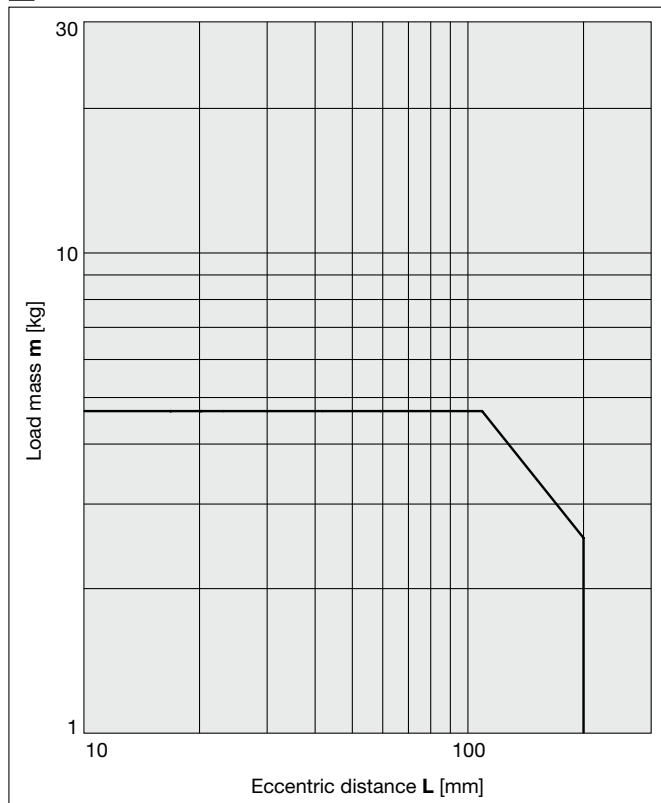

24 Over 50 mm stroke, V = 400 mm/s

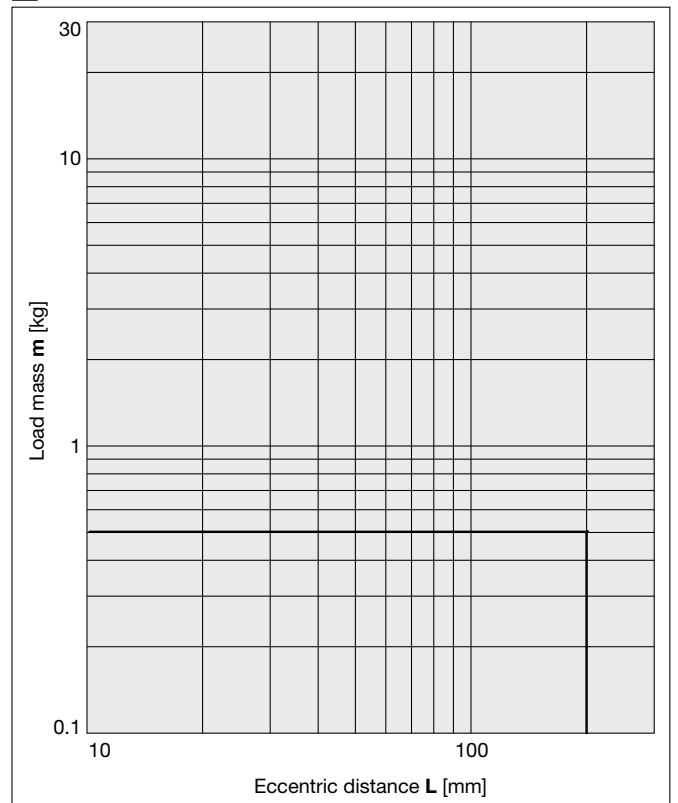

MGPK Series

Horizontal Mounting

Plate Material

Carbon Steel / MGPK□L

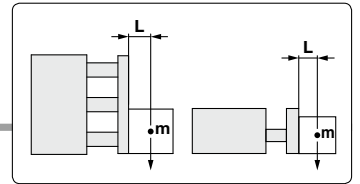

MGPKL16

25 L = 50 mm, V = 200 mm/s or less

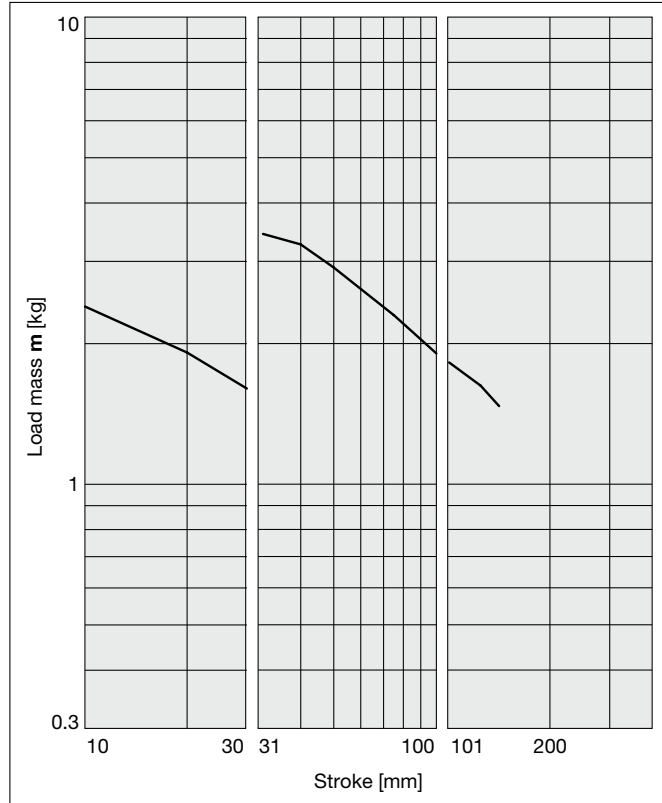

26 L = 100 mm, V = 200 mm/s or less

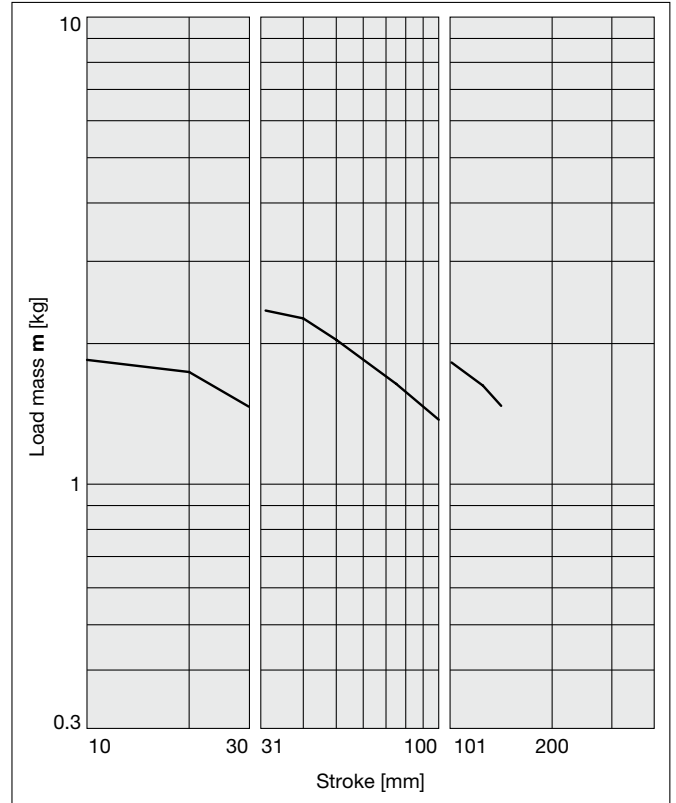

MGPKL32

25 L = 50 mm, V = 200 mm/s or less

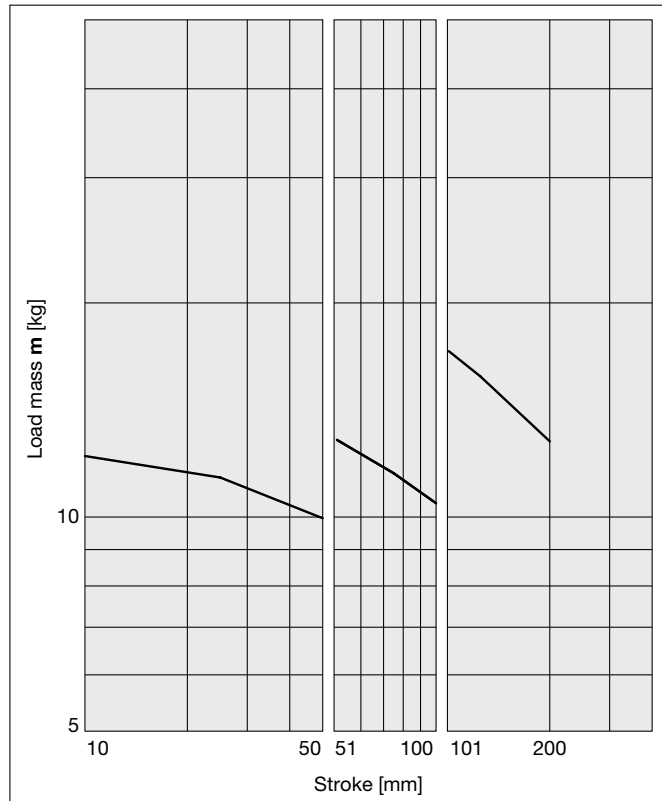

26 L = 100 mm, V = 200 mm/s or less

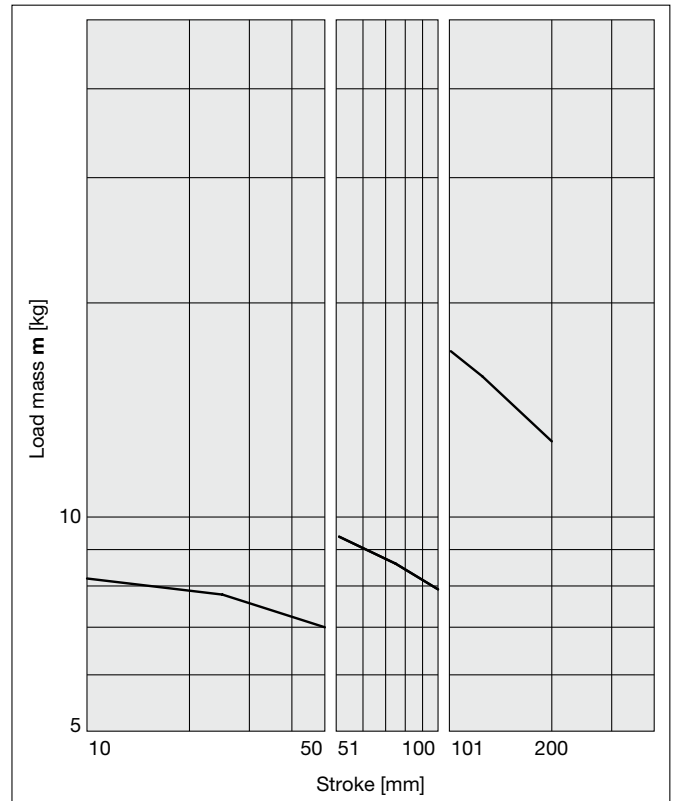

Horizontal Mounting **Plate Material Carbon Steel /MGPK□L**

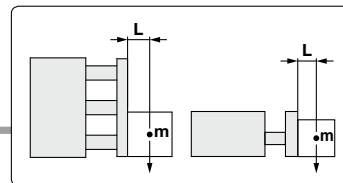

MGPKL16

27 L = 50 mm, V = 400 mm/s

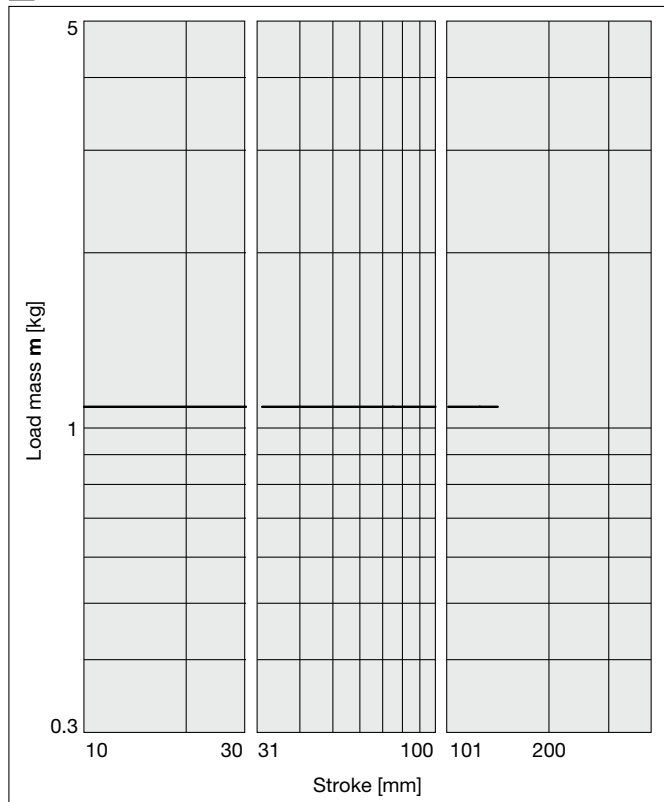

28 L = 100 mm, V = 400 mm/s

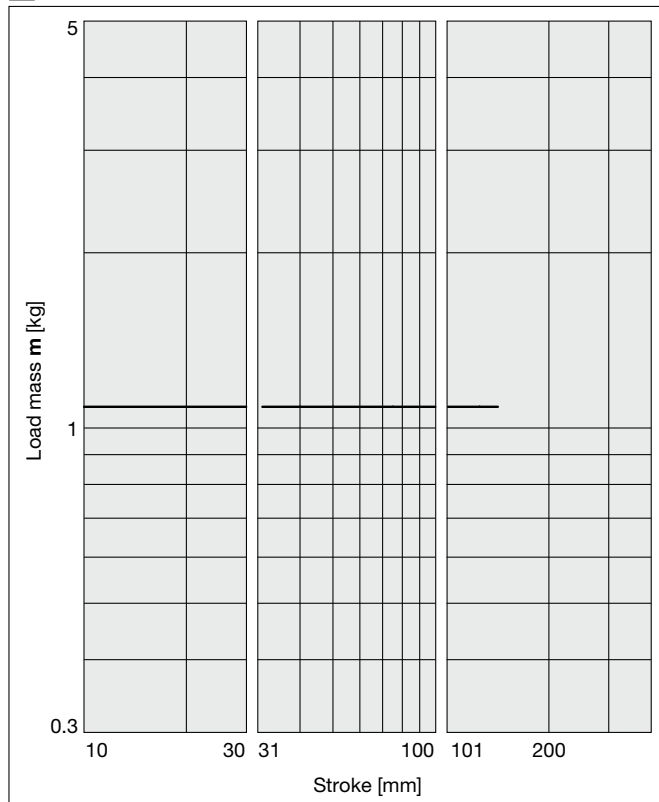

MGPKL32

27 L = 50 mm, V = 400 mm/s

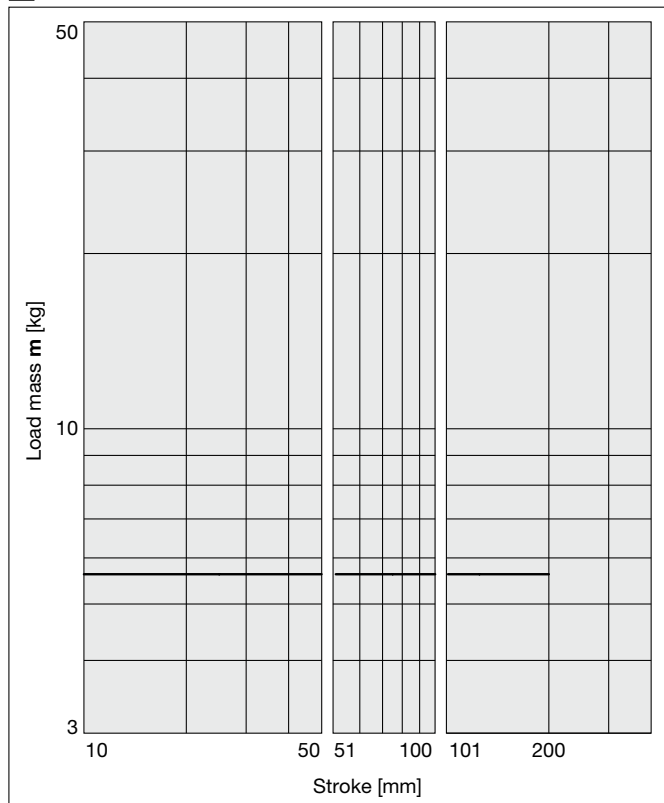

28 L = 100 mm, V = 400 mm/s

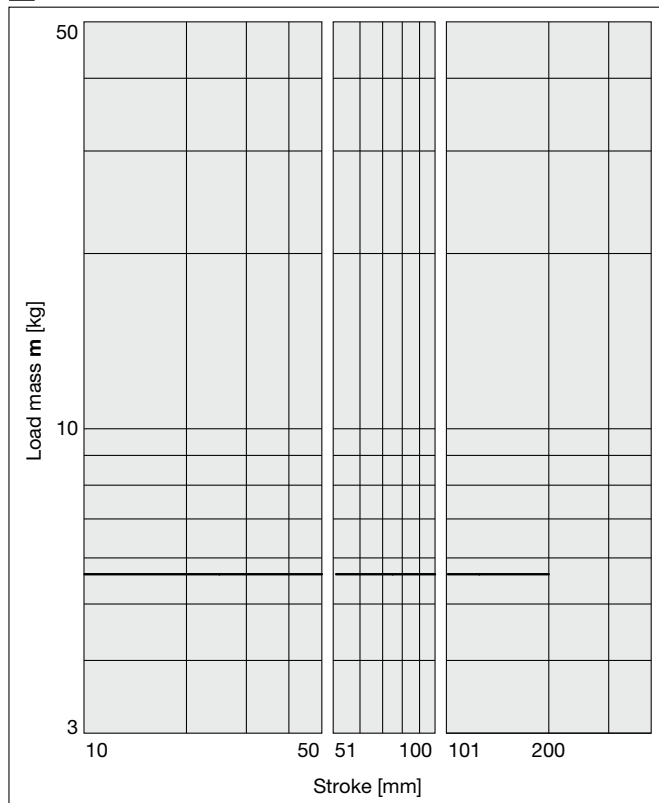

MGPK Series

Vertical Mounting Plate Material **Aluminum Alloy** /MGPK□L

—— Operating pressure: 0.4 MPa - - - - - Operating pressure: 0.5 MPa or more

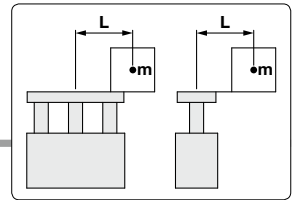

MGPKL16

29 30 mm stroke or less, V = 200 mm/s or less

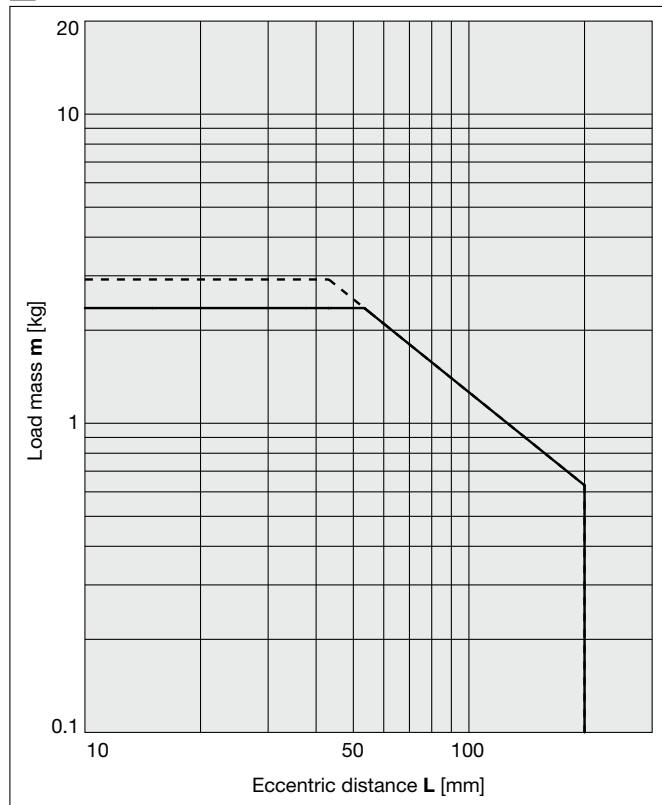

30 Over 30 mm stroke, V = 200 mm/s or less

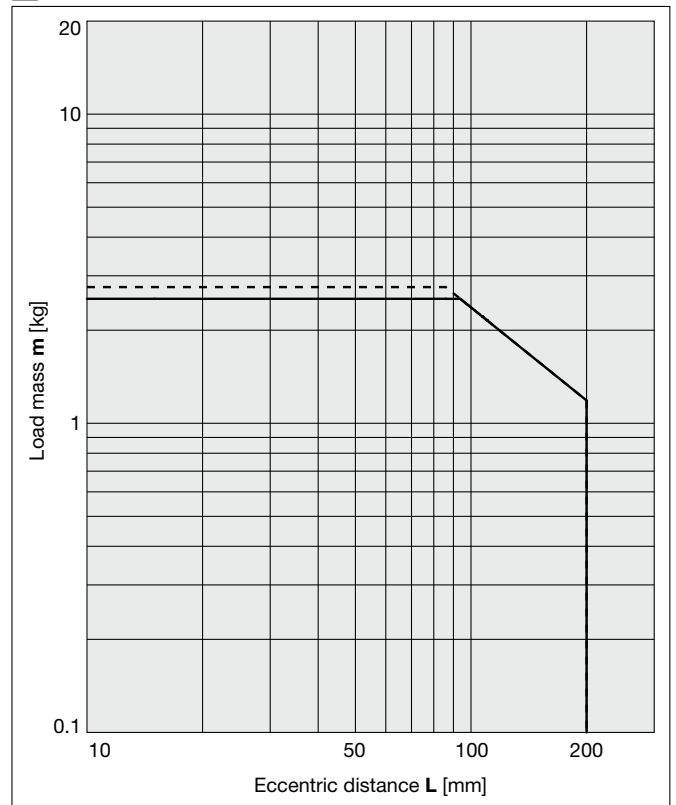

MGPKL32

31 50 mm stroke or less, V = 200 mm/s or less

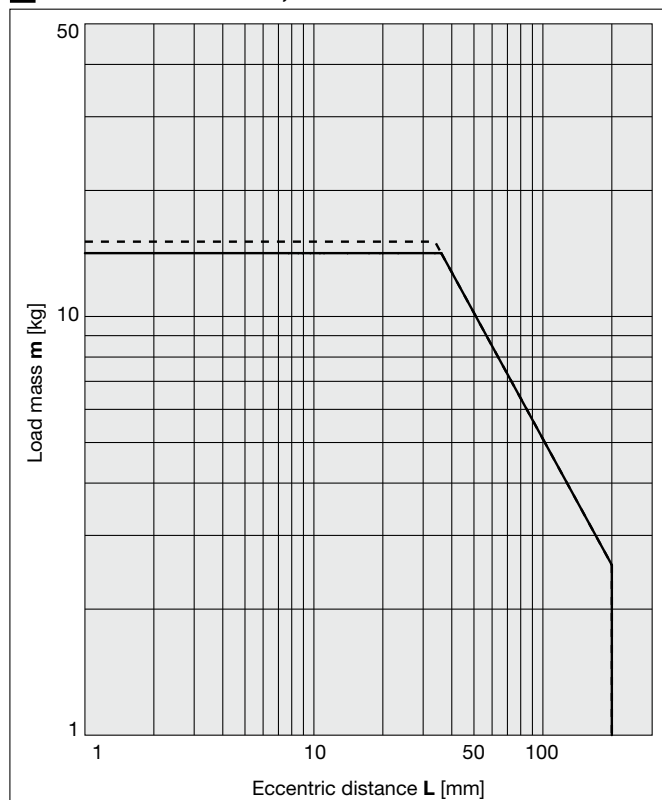

32 Over 50 mm stroke, V = 200 mm/s or less

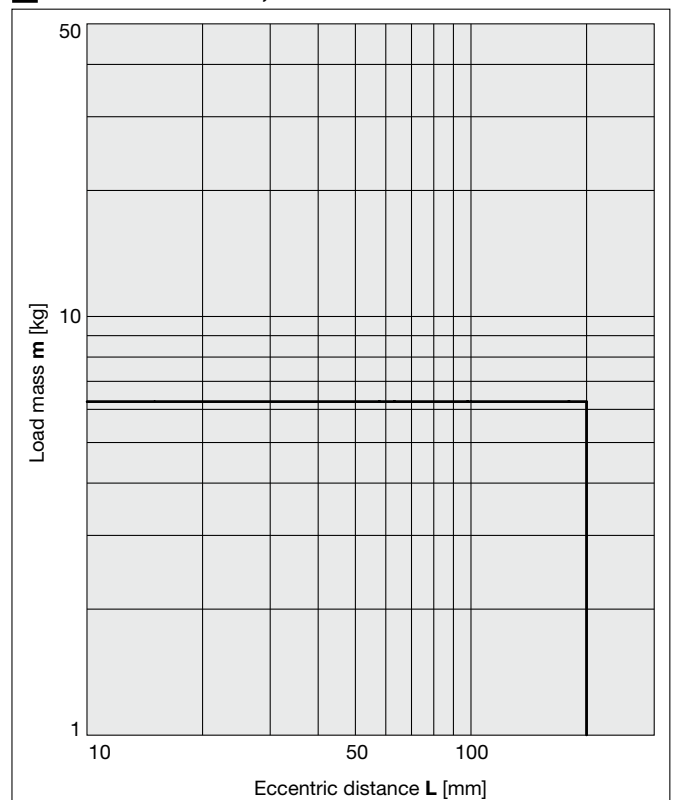

Vertical Mounting Plate Material **Aluminum Alloy** /MGPK□L

—— Operating pressure: 0.4 MPa - - - - - Operating pressure: 0.5 MPa or more

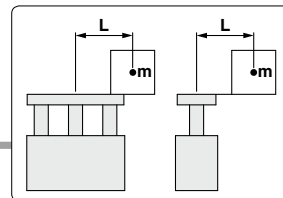

MGPKL16

33 30 mm stroke or less, V = 400 mm/s

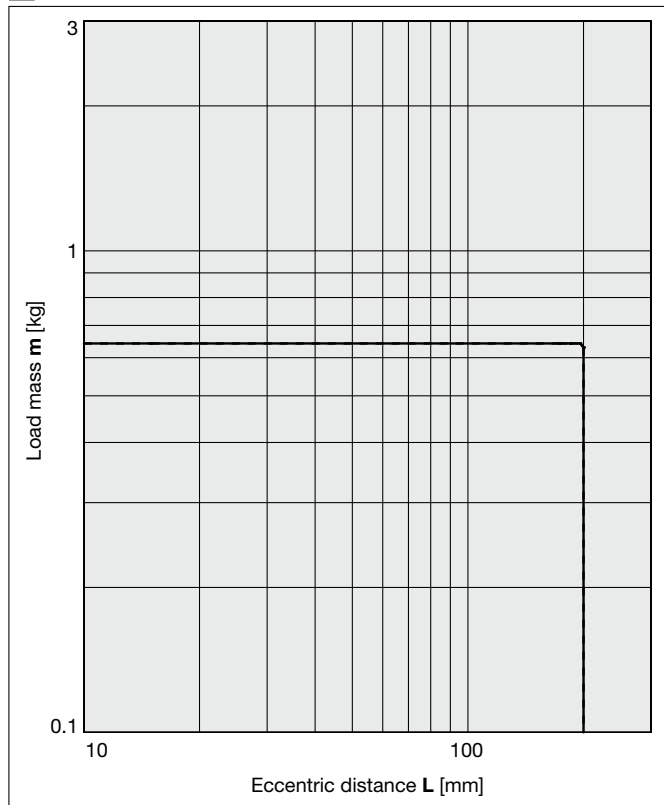

34 Over 30 mm stroke, V = 400 mm/s

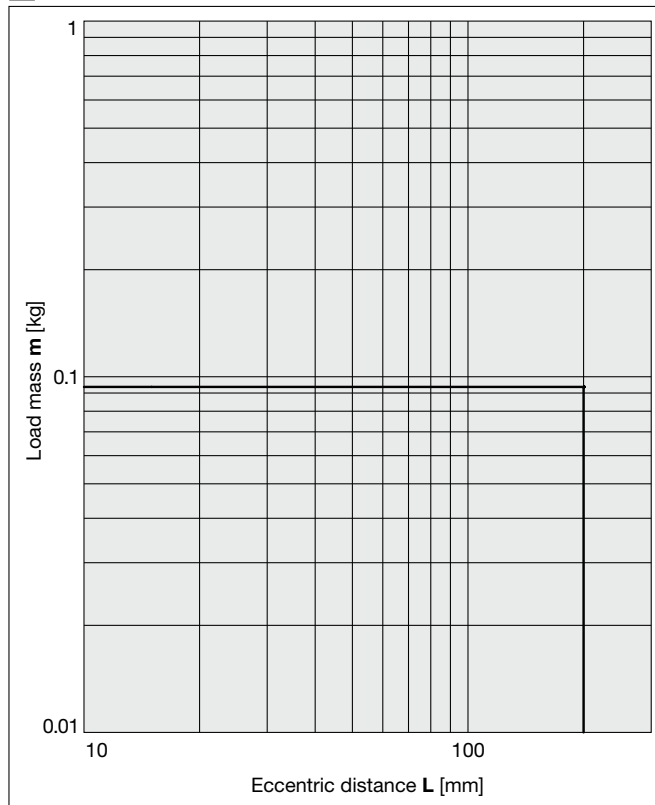

MGPKL32

35 50 mm stroke or less, V = 400 mm/s

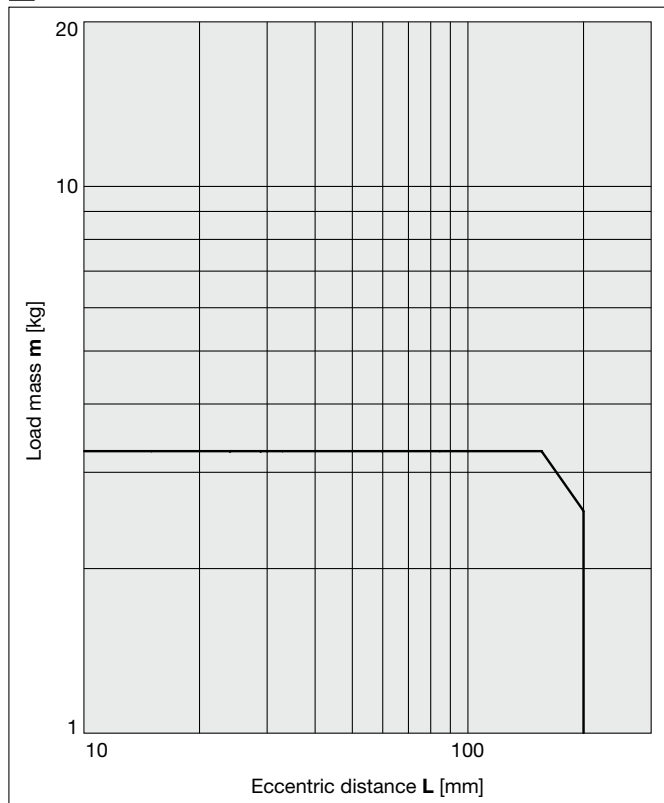

36 Over 50 mm stroke, V = 400 mm/s

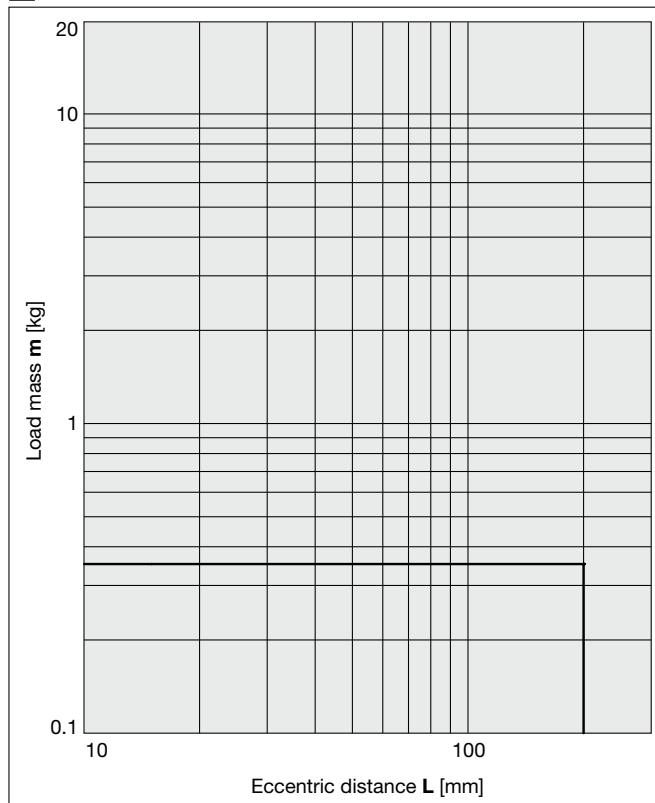

MGPK Series

Horizontal Mounting

Plate Material **Aluminum Alloy** /MGPK□L

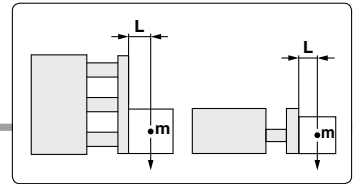

MGPKL16

37 L = 50 mm, V = 200 mm/s or less

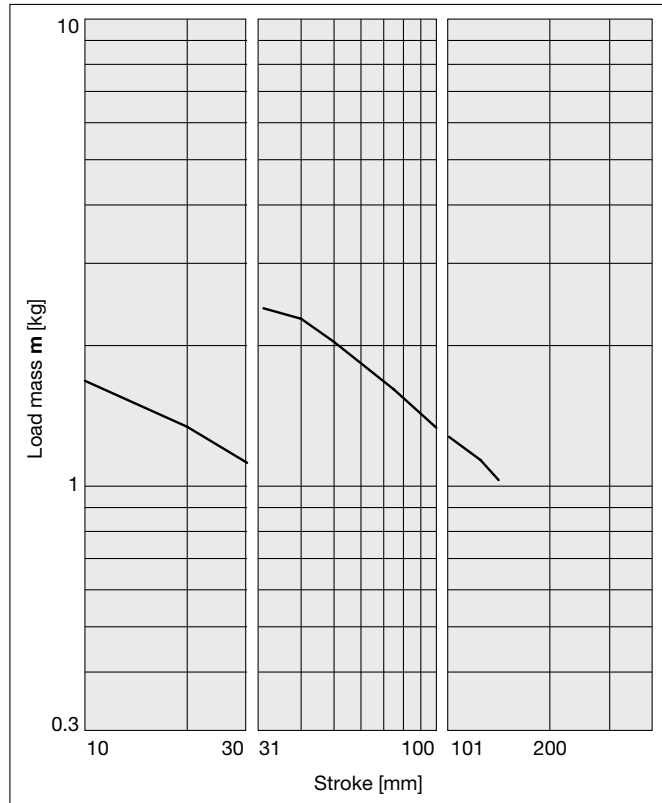

38 L = 100 mm, V = 200 mm/s or less

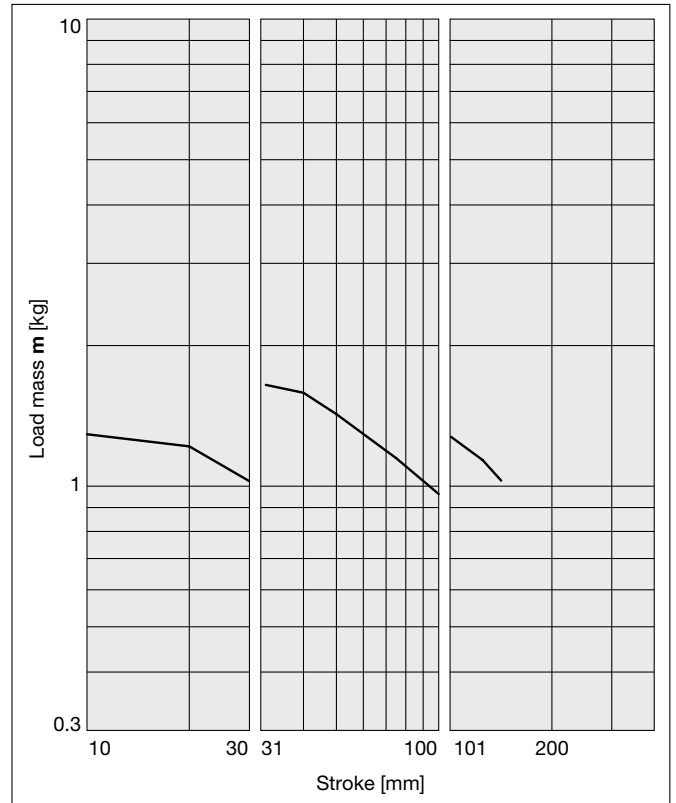

MGPKL32

37 L = 50 mm, V = 200 mm/s or less

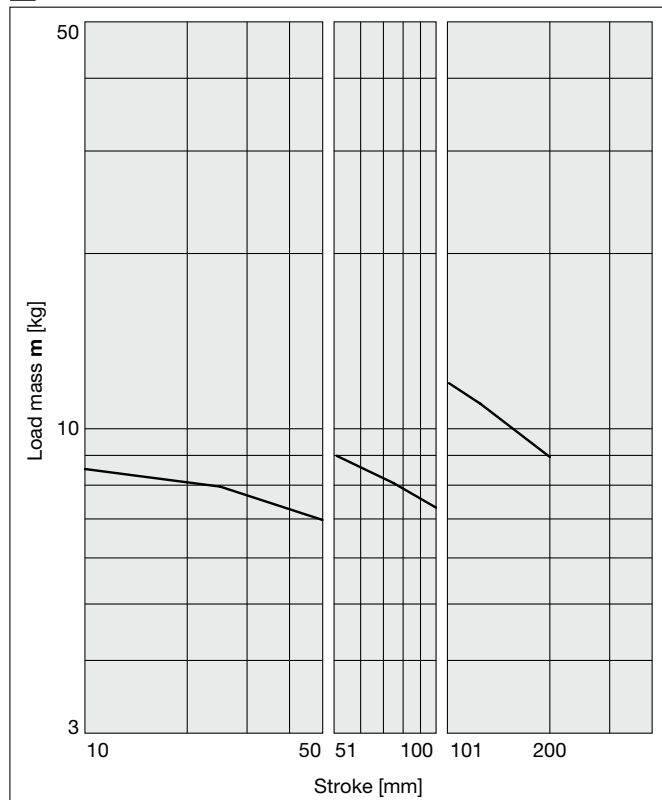

38 L = 100 mm, V = 200 mm/s or less

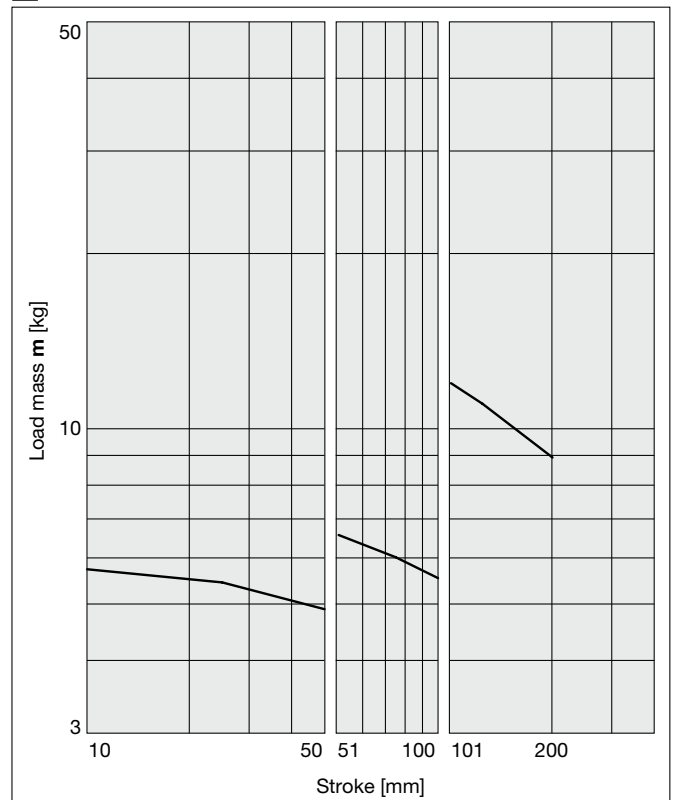

Horizontal Mounting

Plate Material **Aluminum Alloy** /MGPK□L

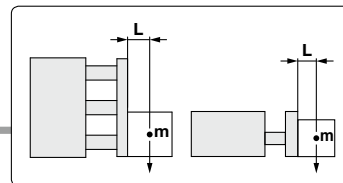

MGPKL16

39 L = 50 mm, V = 400 mm/s

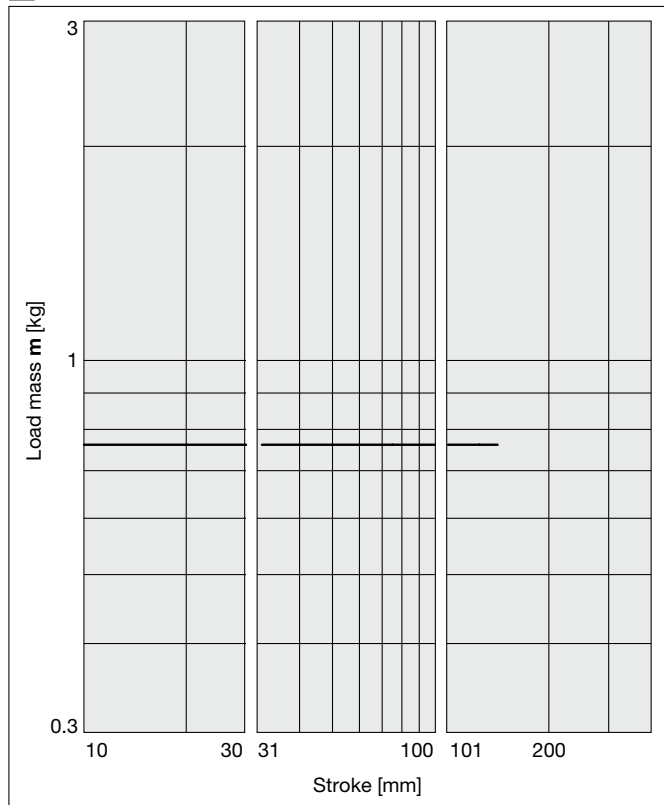

40 L = 100 mm, V = 400 mm/s

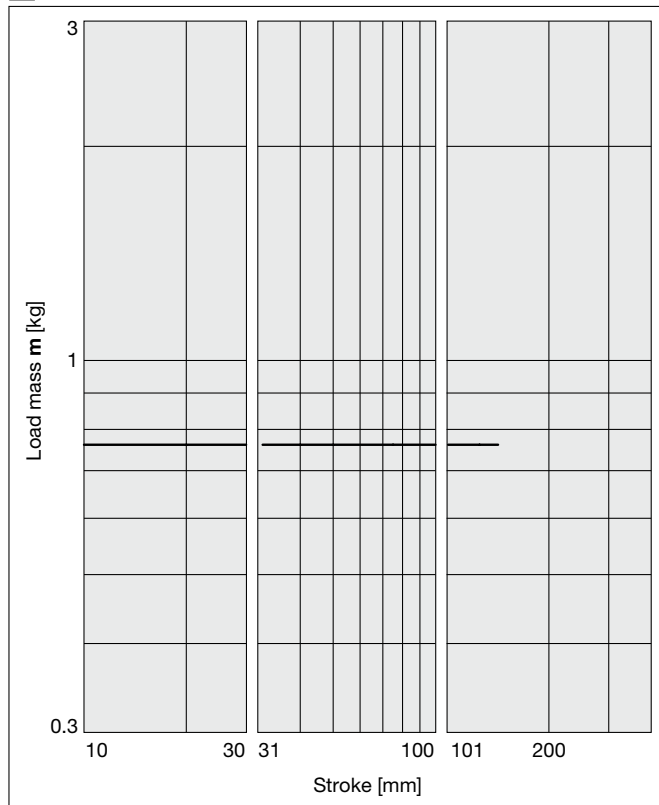

MGPKL32

39 L = 50 mm, V = 400 mm/s

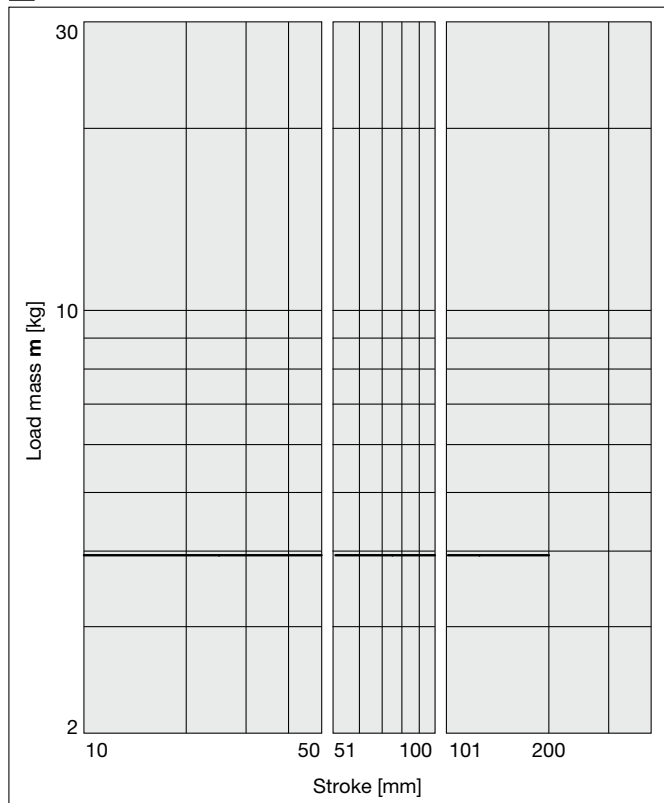

40 L = 100 mm, V = 400 mm/s

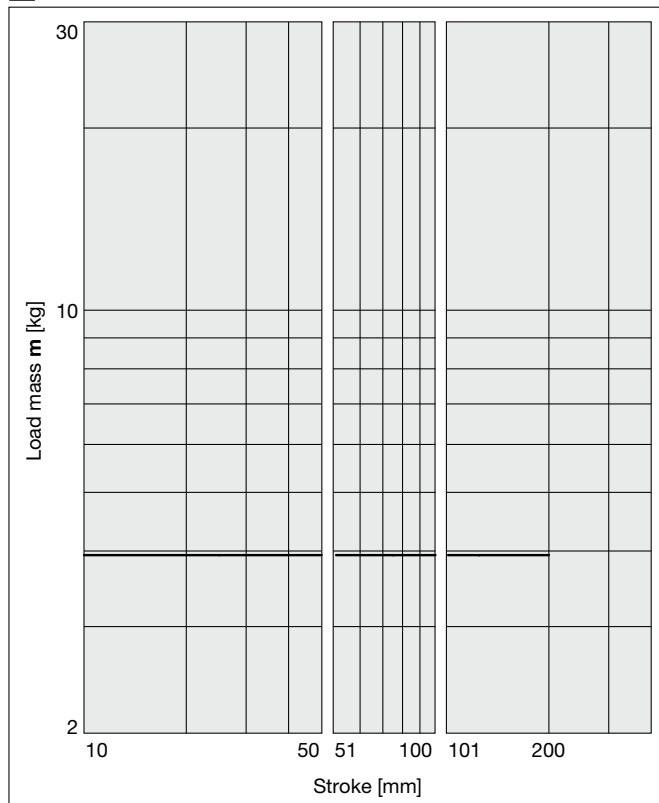

MGPK Series

Operating Range when Used as a Stopper

Bore Sizes $\phi 12$ to $\phi 25$ / MGPKFM12 to 25 (Slide bearing)

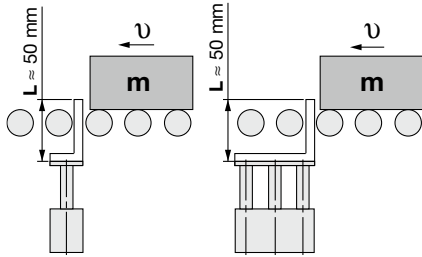

* When selecting a model with a longer **L** dimension, be sure to choose a bore size which is sufficiently large.

⚠ Caution

Handling Precautions

1. When used as a stopper, select a model with a stroke of 30 mm or less.
2. The MGPKA (Plate material: Aluminum alloy) cannot be used as a stopper.

MGPKFM12 to 25 (Slide bearing)

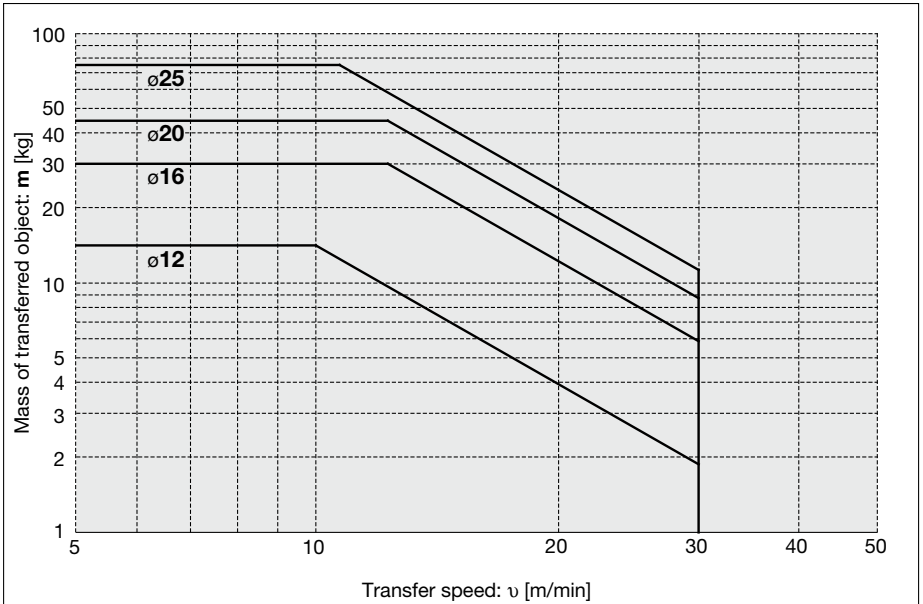

Bore Sizes $\phi 32$ to $\phi 50$ / MGPKFM32 to 50 (Slide bearing)

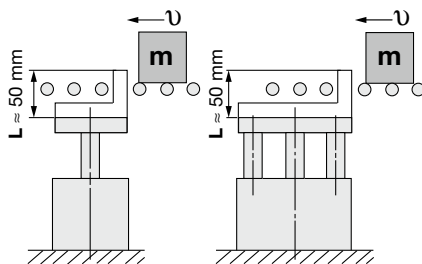

* When selecting a model with a longer **L** dimension, be sure to choose a bore size which is sufficiently large.

⚠ Caution

Handling Precautions

1. When used as a stopper, select a model with a stroke of 50 mm or less.
2. The MGPKA (Plate material: Aluminum alloy) cannot be used as a stopper.

MGPKFM32 to 50 (Slide bearing)

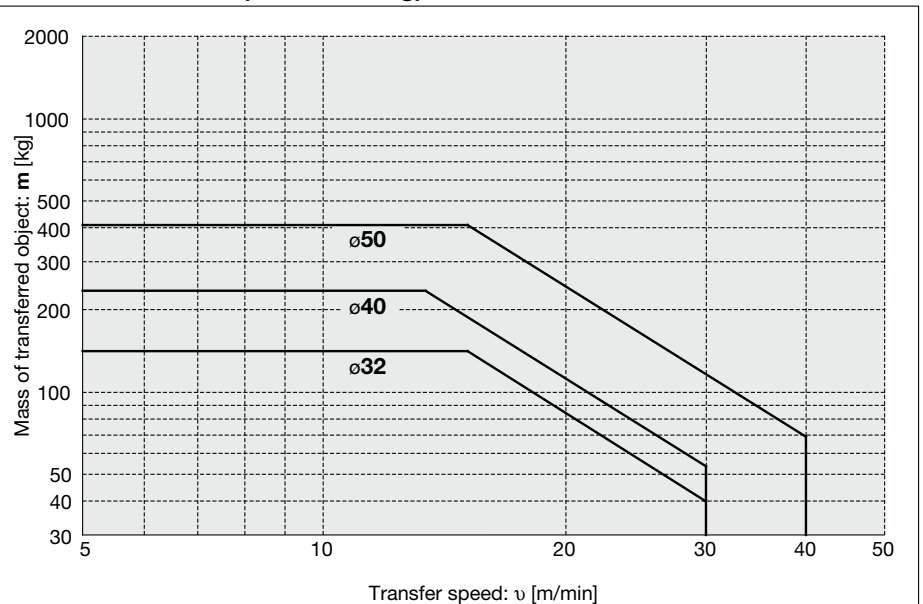

Compact Guide Cylinder/With Air Cushion

MGPK Series

∅12, ∅16, ∅20, ∅25, ∅32, ∅40, ∅50

RoHS

How to Order

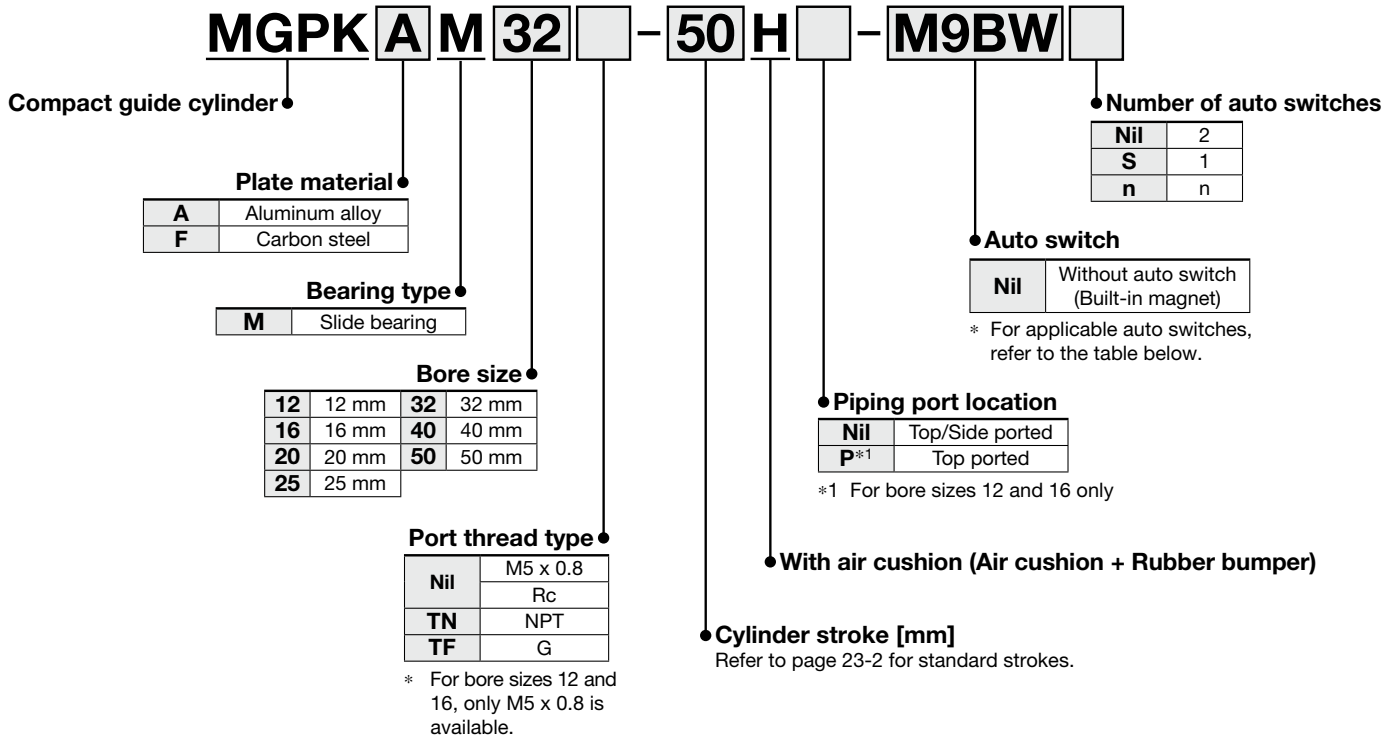

Applicable Auto Switches / Refer to the Web Catalog for further information on auto switches.

Type	Special function	Electrical entry	Indicator light	Wiring (Output)	Load voltage		Auto switch model		Lead wire length [m]				Pre-wired connector	Applicable load				
					DC	AC	Perpendicular	In-line	0.5 (Nil)	1 (M)	3 (L)	5 (Z)						
Solid state auto switch	—	Grommet	Yes	3-wire (NPN)	24 V	5 V, 12 V	—	M9NV	M9N	●	●	●	○	○	IC circuit	Relay, PLC		
				3-wire (PNP)				M9PV	M9P	●	●	●	○	○				
				2-wire				M9BV	M9B	●	●	●	○	○				
	Diagnostic indication (2-color indicator)			3-wire (NPN)	24 V	5 V, 12 V	—	M9NWV	M9NW	●	●	●	○	○	○		IC circuit	
				3-wire (PNP)				M9PWV	M9PW	●	●	●	○	○				
				2-wire				M9BWV	M9BW	●	●	●	○	○				
	Water resistant (2-color indicator)			3-wire (NPN)	24 V	5 V, 12 V	—	M9NAV*1	M9NA*1	○	○	●	○	○	○		IC circuit	
				3-wire (PNP)				M9PAV*1	M9PA*1	○	○	●	○	○				
				2-wire				M9BAV*1	M9BA*1	○	○	●	○	○				
Reed auto switch	—	Grommet	Yes	3-wire (NPN equivalent)	24 V	5 V	—	A96V	A96	●	—	●	—	IC circuit	—			
				2-wire				100 V	A93V*2	A93	●	●	●			●	—	—
								100 V or less	A90V	A90	●	—	●			—		

*1 Water-resistant type auto switches can be mounted on the above models, but SMC cannot guarantee water resistance.

*2 The 1 m lead wire is only applicable to the D-A93.

* Lead wire length symbols: 0.5 m.....Nil (Example) M9NW
1 m.....M (Example) M9NWM
3 m.....L (Example) M9NWL
5 m.....Z (Example) M9NWX

* Solid state auto switches marked with a "○" are produced upon receipt of order.

* For details on auto switches with pre-wired connectors, refer to the Web Catalog.

* Auto switches are shipped together with the product but do not come assembled.

MGPK Series



Symbol

Air cushion

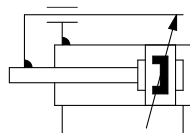

Refer to page 24 for cylinders with auto switches.

- Auto Switch Proper Mounting Position (Detection at stroke end) and Mounting Height
- Minimum Stroke for Auto Switch Mounting
- Operating Range
- Auto Switch Mounting

Specifications

Bore size [mm]	ø12	ø16	ø20	ø25	ø32	ø40	ø50
Action	Double acting						
Fluid	Air						
Proof pressure	1.5 MPa						
Max. operating pressure	1.0 MPa						
Min. operating pressure	0.15 MPa	0.12 MPa					
Ambient and fluid temperatures	-10 to 60°C (No freezing)						
Piston speed*1	50 to 500 mm/s						
Cushion	Air cushion on both sides (with bumper)						
Lubrication	Not required (Non-lube)						
Stroke length tolerance	0 to $^{+1.5}_0$ mm*2						

*1 Speed with no load. Depending on the operating conditions, the piston speed may not be satisfied.

*2 Stroke length tolerance does not include the amount of bumper change.

Standard Strokes

Bore size [mm]	Standard stroke [mm]
12, 16	25, 50, 75, 100, 125, 150
20 to 50	25, 50, 75, 100, 125, 150, 175, 200

* Intermediate strokes are available as a special order.

Theoretical Output

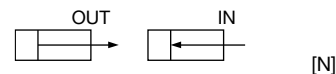

Bore size [mm]	Rod size [mm]	Operating direction	Piston area [mm ²]	Operating pressure [MPa]									
				0.2	0.3	0.4	0.5	0.6	0.7	0.8	0.9	1.0	
12	6	OUT	113	23	34	45	57	68	79	90	102	113	
		IN	85	17	25	34	42	51	59	68	76	85	
16	8	OUT	201	40	60	80	101	121	141	161	181	201	
		IN	151	30	45	60	75	90	106	121	136	151	
20	10	OUT	314	63	94	126	157	188	220	251	283	314	
		IN	236	47	71	94	118	141	165	188	212	236	
25	10	OUT	491	98	147	196	245	295	344	393	442	491	
		IN	412	82	124	165	206	247	289	330	371	412	
32	14	OUT	804	161	241	322	402	483	563	643	724	804	
		IN	650	130	195	260	325	390	455	520	585	650	
40	16	OUT	1257	251	377	503	628	754	880	1005	1131	1257	
		IN	1056	211	317	422	528	634	739	845	950	1056	
50	20	OUT	1963	393	589	785	982	1178	1374	1571	1767	1963	
		IN	1649	330	495	660	825	990	1154	1319	1484	1649	

* Theoretical output [N] = Pressure [MPa] x Piston area [mm²]

Weight

MGPK□M12 to 50

[kg]

Bore size [mm]	Plate material	Standard stroke [mm]							
		25	50	75	100	125	150	175	200
12	Carbon steel	0.30	0.40	0.49	0.59	0.67	0.75	—	—
	Aluminum alloy	0.27	0.37	0.45	0.55	0.64	0.72	—	—
16	Carbon steel	0.38	0.50	0.60	0.72	0.82	0.92	—	—
	Aluminum alloy	0.34	0.46	0.56	0.68	0.77	0.87	—	—
20	Carbon steel	0.65	0.84	0.99	1.14	1.29	1.44	1.60	1.78
	Aluminum alloy	0.57	0.76	0.91	1.06	1.21	1.37	1.52	1.71
25	Carbon steel	0.91	1.18	1.38	1.58	1.78	1.98	2.18	2.46
	Aluminum alloy	0.78	1.06	1.26	1.46	1.66	1.86	2.05	2.33
32	Carbon steel	1.30	1.62	1.89	2.16	2.42	2.69	2.96	3.34
	Aluminum alloy	1.10	1.43	1.69	1.96	2.23	2.49	2.76	3.14
40	Carbon steel	1.65	2.01	2.32	2.63	2.94	3.24	3.55	3.97
	Aluminum alloy	1.42	1.78	2.09	2.39	2.70	3.01	3.32	3.74
50	Carbon steel	2.77	3.33	3.80	4.27	4.73	5.20	5.67	6.33
	Aluminum alloy	2.28	2.84	3.31	3.78	4.24	4.71	5.18	5.84

Allowable Rotational Torque of Plate

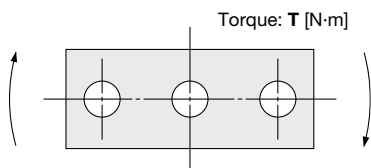

MGPK□M12 to 50

[N·m]

Bore size [mm]	Standard stroke [mm]							
	25	50	75	100	125	150	175	200
12	0.29	0.52	0.42	0.36	0.31	0.27	—	—
16	0.53	0.84	0.69	0.58	0.5	0.44	—	—
20	0.99	2.23	1.88	1.63	1.44	1.28	1.16	1.06
25	1.64	3.51	2.96	2.57	2.26	2.02	1.83	1.67
32	6.35	6.64	5.69	4.97	4.42	3.98	3.61	3.31
40	7	7.32	6.27	5.48	4.87	4.38	3.98	3.65
50	13	13.8	12	10.6	9.5	8.6	7.86	7.24

MGPK Series

Non-rotating Accuracy of Plate

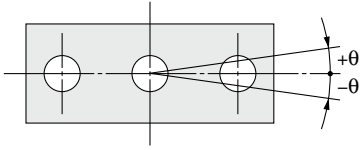

Non-rotating accuracy θ when retracted and when no load is applied should be not more than the values shown in the table.

Bore size [mm]	Non-rotating accuracy θ
	MGPK□M
12	$\pm 0.07^\circ$
16	
20	
25	$\pm 0.06^\circ$
32	
40	$\pm 0.05^\circ$
50	$\pm 0.04^\circ$

Allowable Kinetic Energy

⚠ Caution

The load mass and a max. speed must be within the ranges shown below.

* Refer to "Model Selection" on page 23-8 for the selection method.

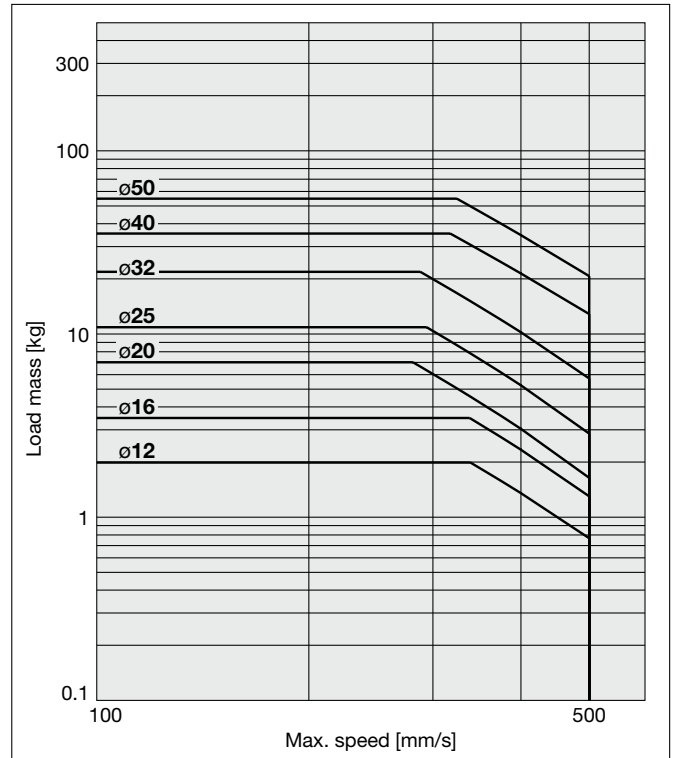

Replacement Parts: MGPK□M-□H Series

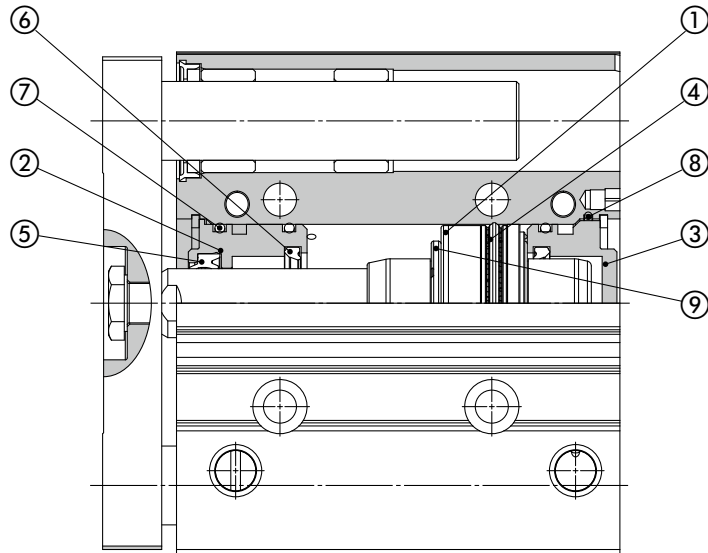

Component Parts

No.	Description	Note
1	Piston	
2	Collar	
3	Head cover	
4	Piston seal	
5	Rod seal	
6	Cushion seal	
7	Gasket A	
8	Gasket B	ø16 to ø50
9	Bumper	

Replacement Parts: Seal Kit

Bore size [mm]	Kit no.	Contents
12	MGPK12-H-PS	Set of nos. ④, ⑤, ⑥, ⑦, ⑧
16	MGPK16-H-PS	
20	MGPK20-H-PS	
25	MGPK25-H-PS	
32	MGPK32-H-PS	
40	MGPK40-H-PS	
50	MGPK50-H-PS	

* The seal kit includes ④ to ⑧. Order the seal kit based on each bore size.

* The seal kit does not include a grease pack. Order it separately.

Grease pack part number: GR-S-010 (10 g)

MGPK Series

Dimensions: $\varnothing 12$ to $\varnothing 25$ /With Air Cushion

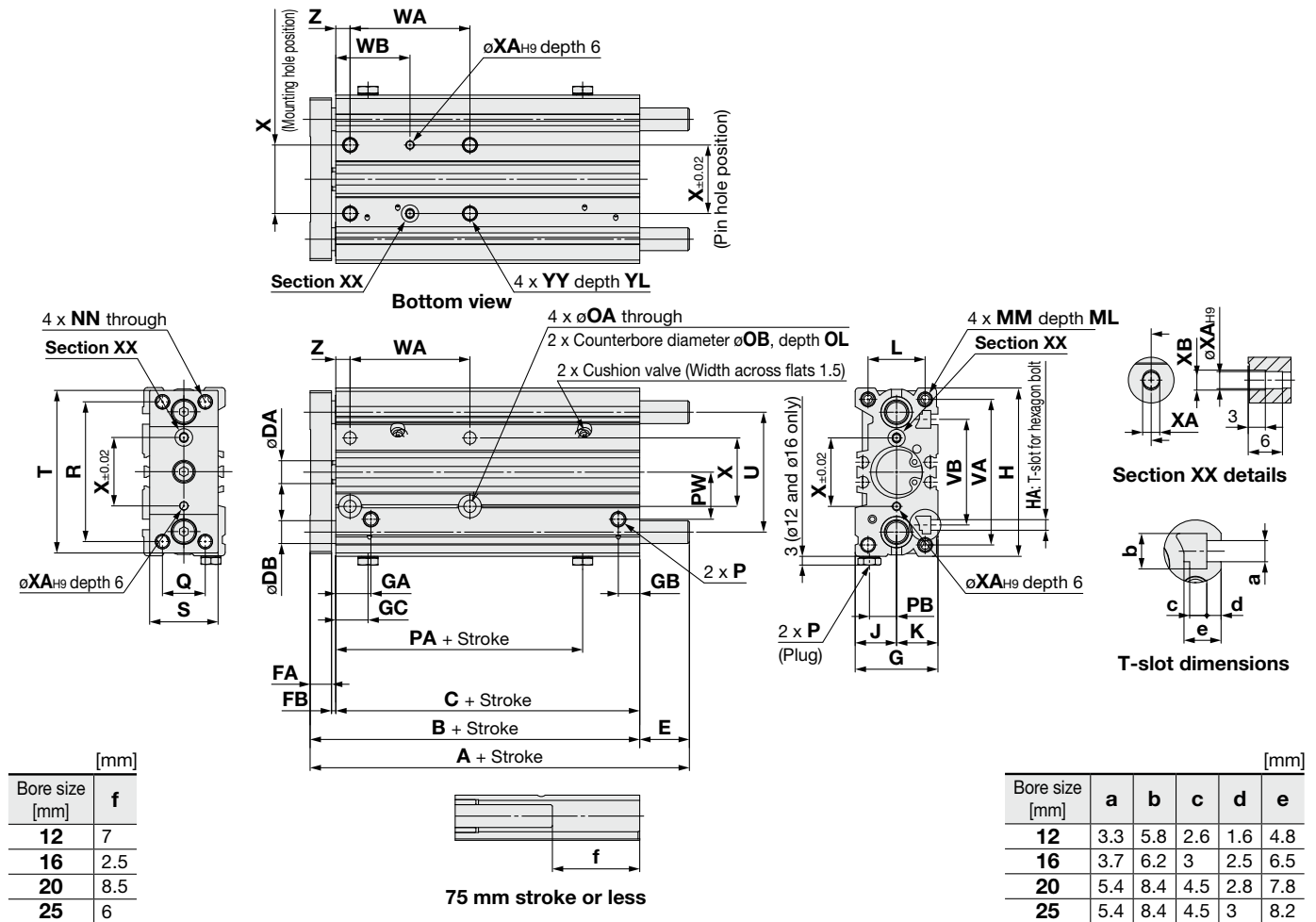

* The use of a slot (width XA, length XB, depth 3) allows for a relaxed pin pitch tolerance, with the pin hole ($\varnothing XA_{H9}$, depth 6) as the reference, without affecting mounting accuracy.

MGPK□M

Bore size [mm]	Standard stroke	A			B	C	DA	DB	E			FA	FB	G	GA	GB	GC
		75 st or less	100 st to 175 st	200 st					75 st or less	100 st to 175 st	200 st						
		12	25, 50, 75,	64					75	—	64						
16	100, 125, 150	66	86	—	66	56.5	8	8	0	20	—	7.5	2	29	12.5	7.5	11.5
20	25, 50, 75, 100,	77.5	77.5	108	77.5	66	10	10	0	0	30.5	9	2.5	33	12.5	11.5	12.5
25	125, 150, 175, 200	78.5	78.5	109	78.5	65.5	10	14	0	0	30.5	10	3	38	11.5	12.5	11.5

Bore size [mm]	H	HA	J	K	L	MM	ML	NN	OA	OB	OL	P			PA	PB	PW	Q	R	S
												Nil	TN	TF						
												12	54	M3						
16	59	M3.5	14.5	14.5	20	M5 x 0.8	11	M5 x 0.8	4.3	8	4.5	M5 x 0.8			36.5	9.5	16.5	15	49	24
20	78	M5	16.5	16.5	23	M5 x 0.8	13	M5 x 0.8	5.4	9.5	5.5	Rc1/8	NPT1/8	G1/8	40.5	8.5	25	18	60	28.5
25	90	M5	19	19	27	M6 x 1	15	M6 x 1	5.4	9.5	7	Rc1/8	NPT1/8	G1/8	37.5	11	30	22	73	34

Bore size [mm]	T	U	VA	VB	WA			WB			X	XA	XB	YY	YL	Z	f		
					75 st or less	100 st to 175 st	200 st	75 st or less	100 st to 175 st	200 st									
					12	50	37	47	33	40							110	—	25
16	57	42	51	37	42	110	—	26	60	—	24	3	3.5	M5 x 0.8	10	5	31	8	—
20	71	49	66	44	44	120	200	40	78	118	28	3	3.5	M6 x 1	12	18	35	2	2
25	86	60	78	50	44	120	200	39	77	117	34	4	4.5	M6 x 1	12	17	33.5	1.5	1.5

MGPK Series Model Selection

Selection Conditions

Mounting orientation		Vertical		Horizontal	
Bearing type	Plate material	Max. speed [mm/s]			
		200 or less	400	200 or less	400
Slide bearing	Carbon steel	1, 2	3, 4	5, 6	7, 8
	Aluminum alloy	9, 10	11, 12	13, 14	15, 16

Selection Example 1 (Vertical Mounting)

Selection conditions

Mounting: Vertical
 Bearing type: Slide bearing
 Stroke: 75 mm stroke
 Max. speed: 200 mm/s
 Load mass: 6 kg
 Eccentric distance: 70 mm

Find the point of intersection for the load mass of 6 kg and the eccentric distance of 70 mm on graph **2**, based on vertical mounting, slide bearing, 75 mm stroke, and the speed of 200 mm/s.

→ The **MGPKFM20-75H** should be selected.

2 Over 25 mm stroke, V = 200 mm/s

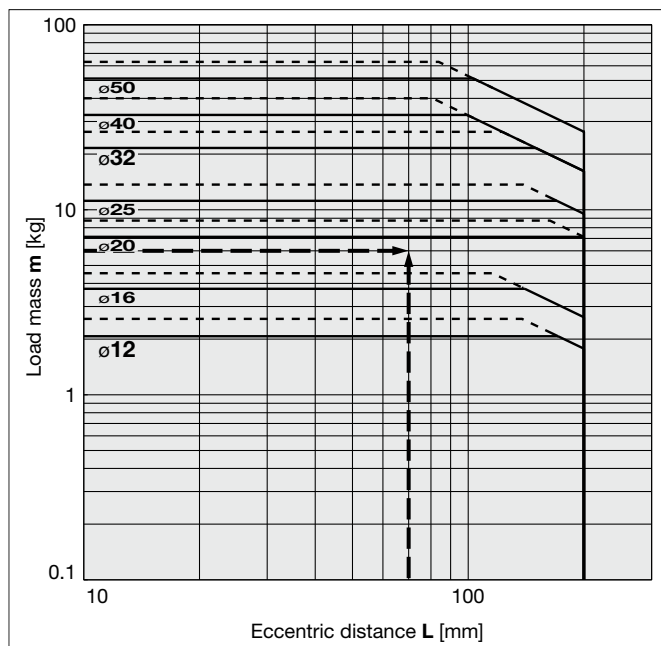

Selection Example 2 (Horizontal Mounting)

Selection conditions

Mounting: Horizontal
 Bearing type: Slide bearing
 Distance between plate and load center of gravity: 40 mm
 Max. speed: 400 mm/s
 Load mass: 8 kg
 Stroke: 100 mm stroke

Find the point of intersection for the load mass of 8 kg and 100 mm stroke on graph **7**, based on horizontal mounting, slide bearing, the distance of 40 mm between the plate and load center of gravity, and the speed of 400 mm/s.

→ The **MGPKFM32-100H** should be selected.

7 25 mm stroke or less, L = 50 mm, V = 400 mm/s

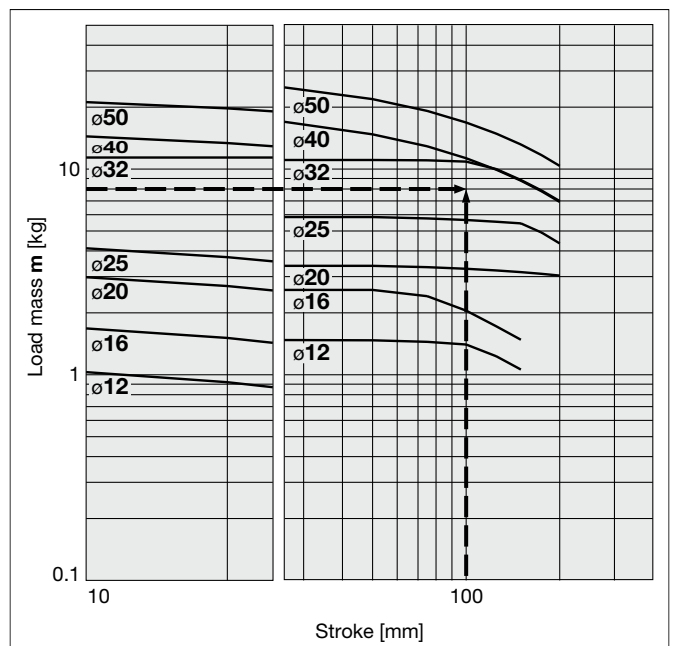

· When the max. speed exceeds 200 mm/s, the allowable load mass is determined by multiplying the value shown in the graph at 400 mm/s by the coefficient listed in the table below.

Max. speed	Up to 300 mm/s	Up to 400 mm/s	Up to 500 mm/s
Coefficient	1.7	1	0.6

Vertical Mounting

Plate Material **Carbon Steel** /MGP**K**□**M**

— Operating pressure: 0.4 MPa - - - - - Operating pressure: 0.5 MPa or more

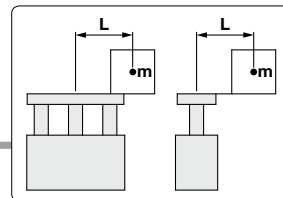

MGP**K**□**M**

1 25 mm stroke or less, V = 200 mm/s or less

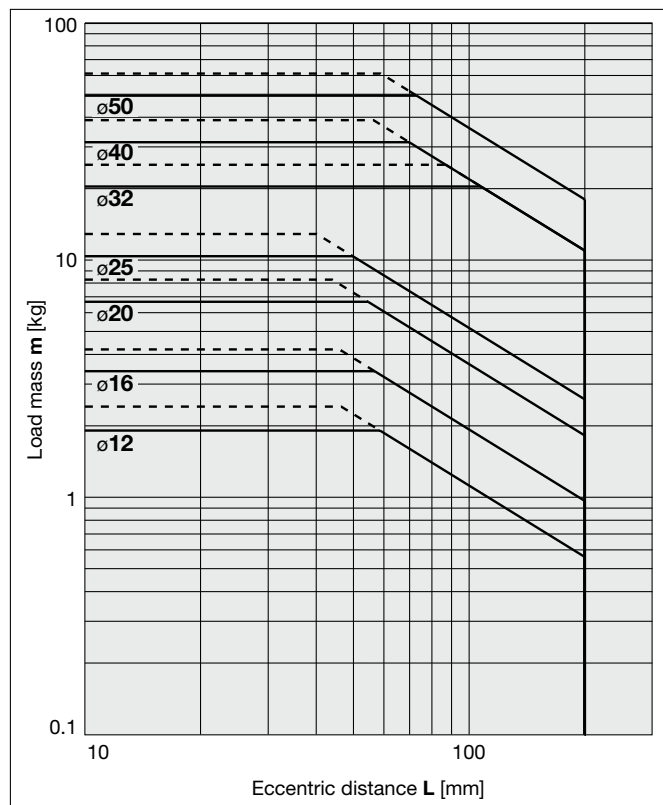

2 Over 25 mm stroke, V = 200 mm/s or less

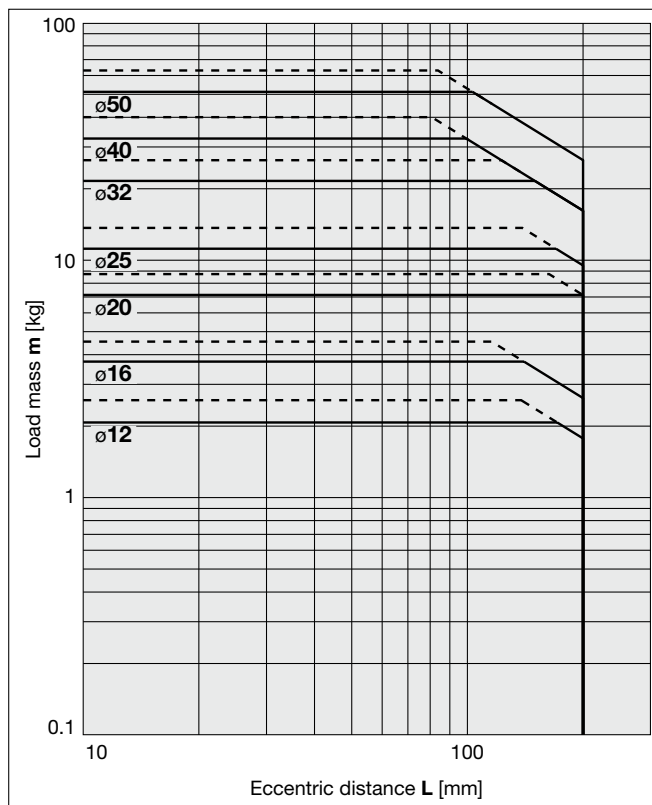

3 25 mm stroke or less, V = 400 mm/s

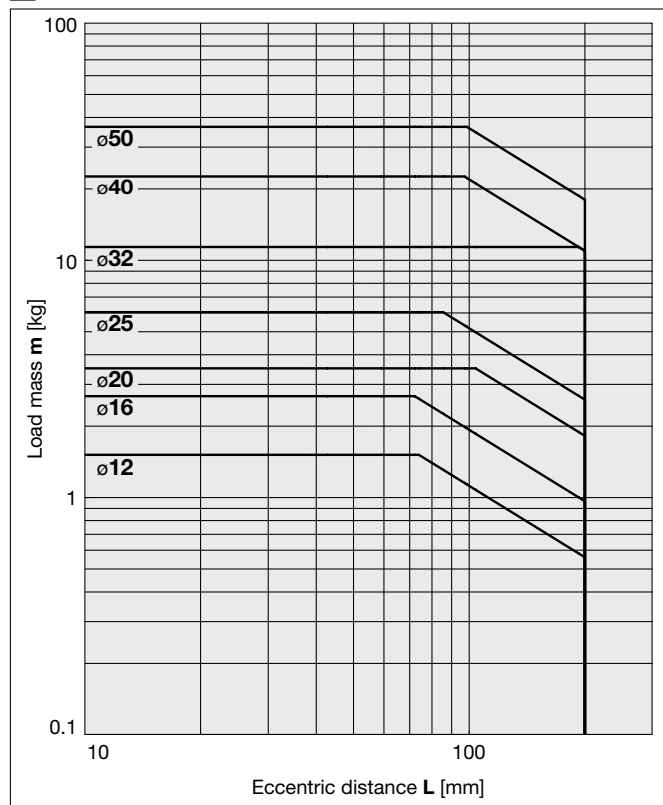

4 Over 25 mm stroke, V = 400 mm/s or less

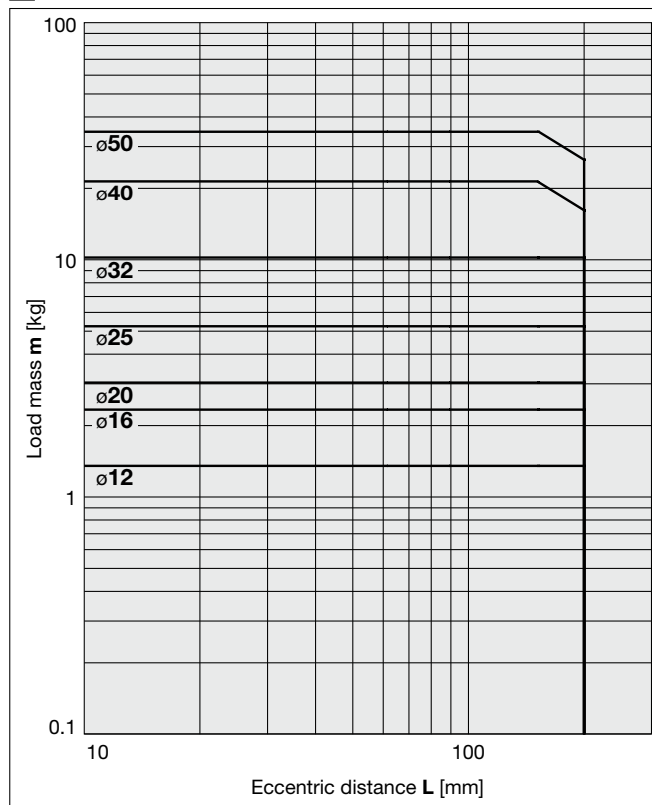

MGPK Series

Horizontal Mounting

Plate Material

Carbon Steel /MGPK□M

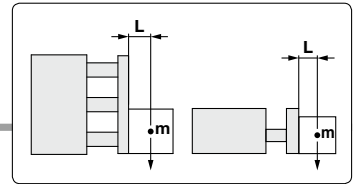

MGPK□M

5 L = 50 mm, V = 200 mm/s or less

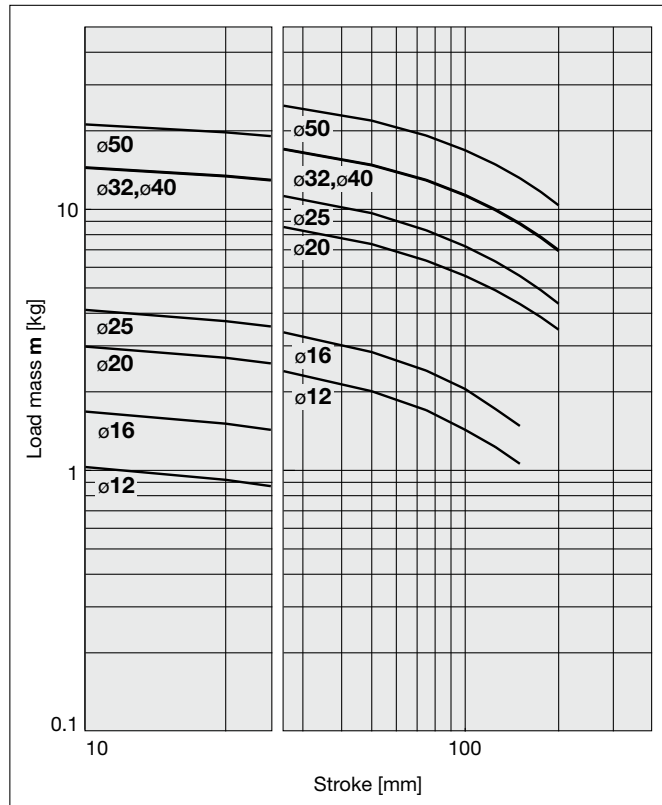

6 L = 100 mm, V = 200 mm/s or less

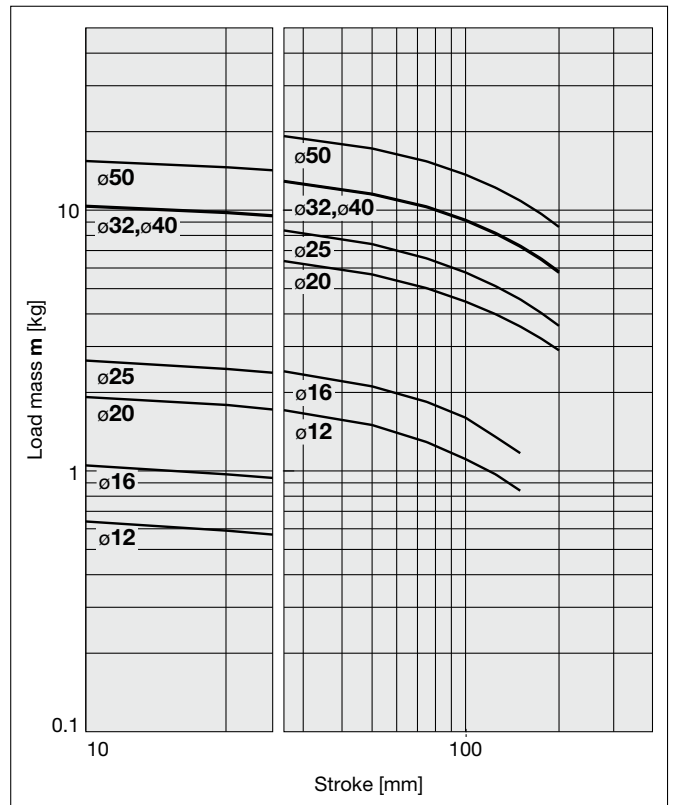

7 L = 50 mm, V = 400 mm/s

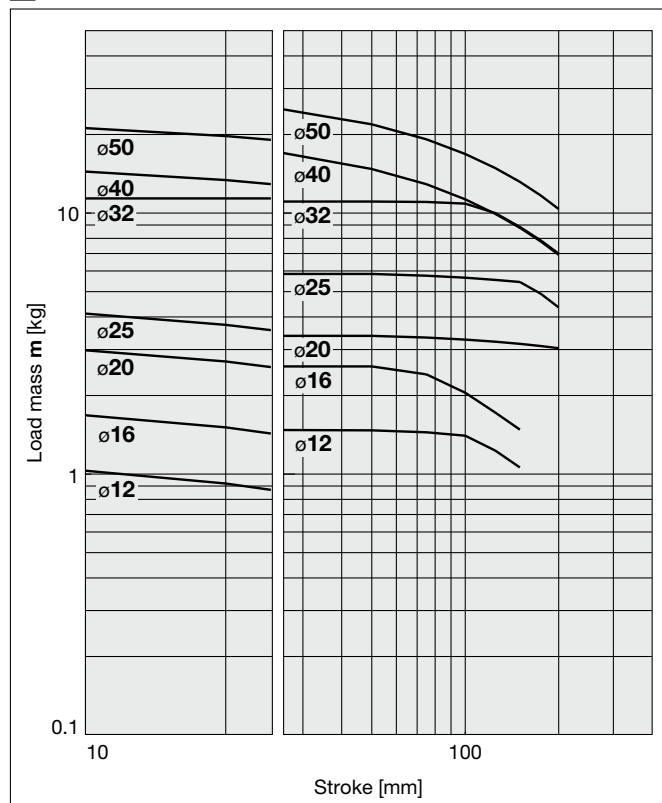

8 L = 100 mm, V = 400 mm/s

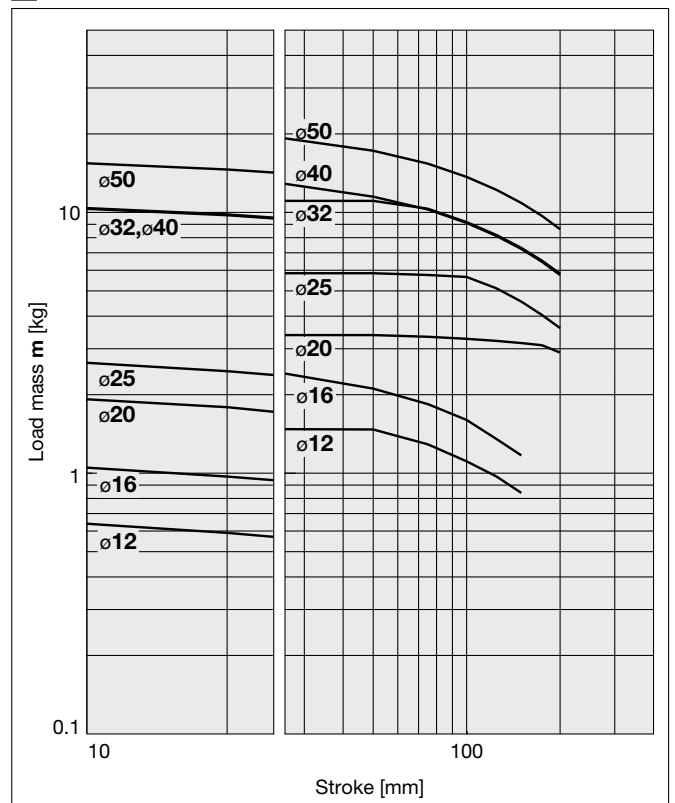

Vertical Mounting Plate Material **Aluminum Alloy** /MGPK□M

————— Operating pressure: 0.4 MPa - - - - - Operating pressure: 0.5 MPa or more

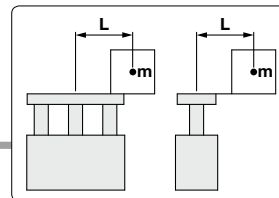

MGPK□M

9 25mm stroke or less, V = 200 mm/s or less

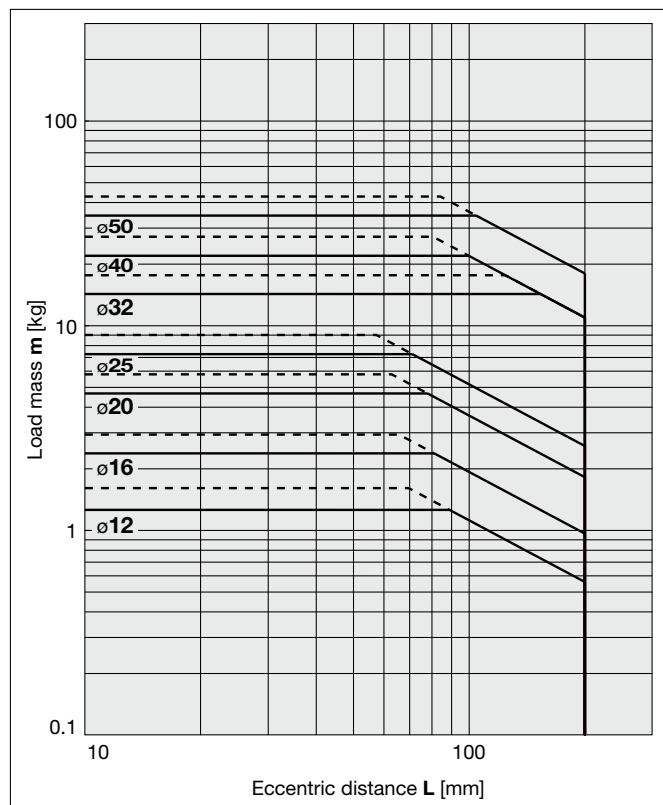

10 Over 25 mm stroke, V = 200 mm/s or less

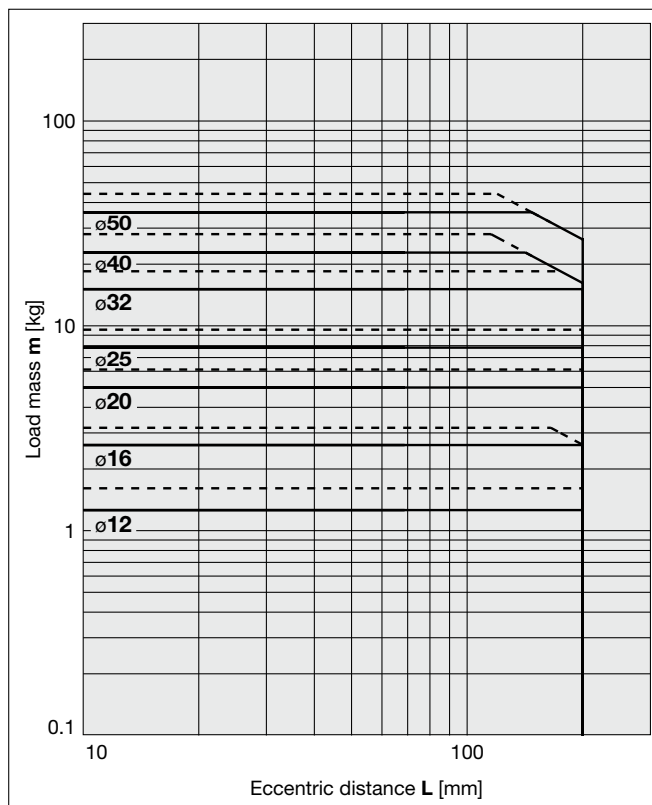

11 25 mm stroke or less, V = 400 mm/s

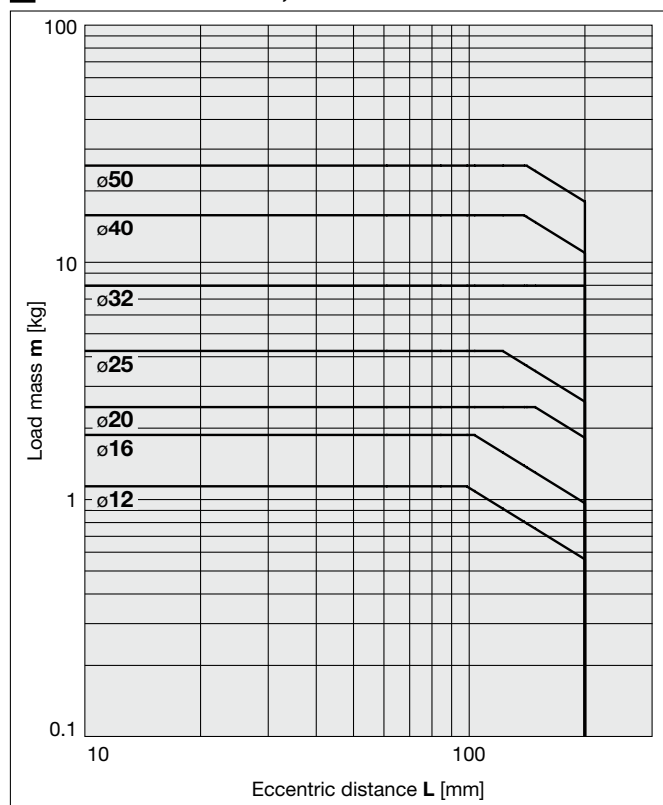

12 Over 25 mm stroke, V = 400 mm/s

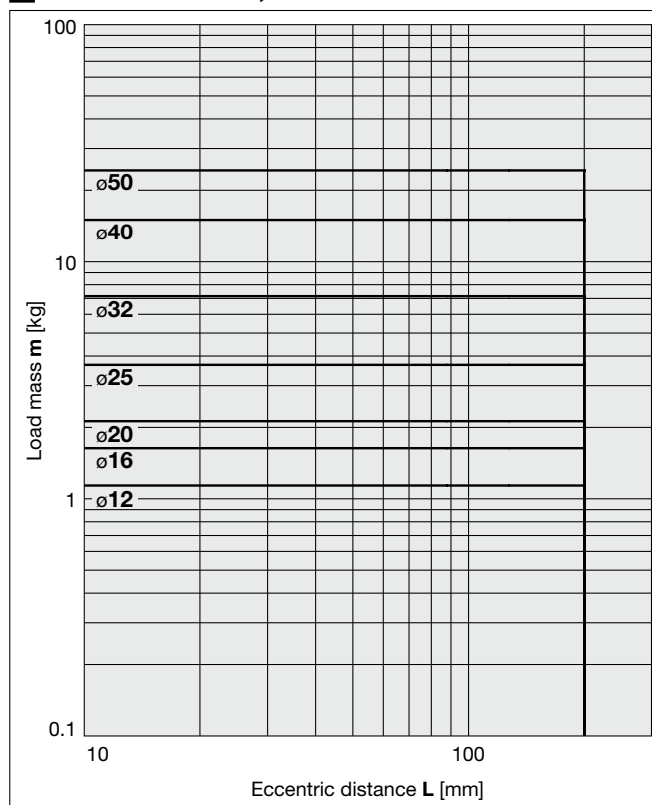

MGPK Series

Horizontal Mounting Plate Material Aluminum Alloy /MGPK□M

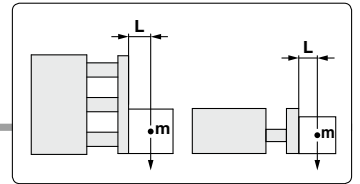

MGPK□M

13 L = 50 mm, V = 200 mm/s or less

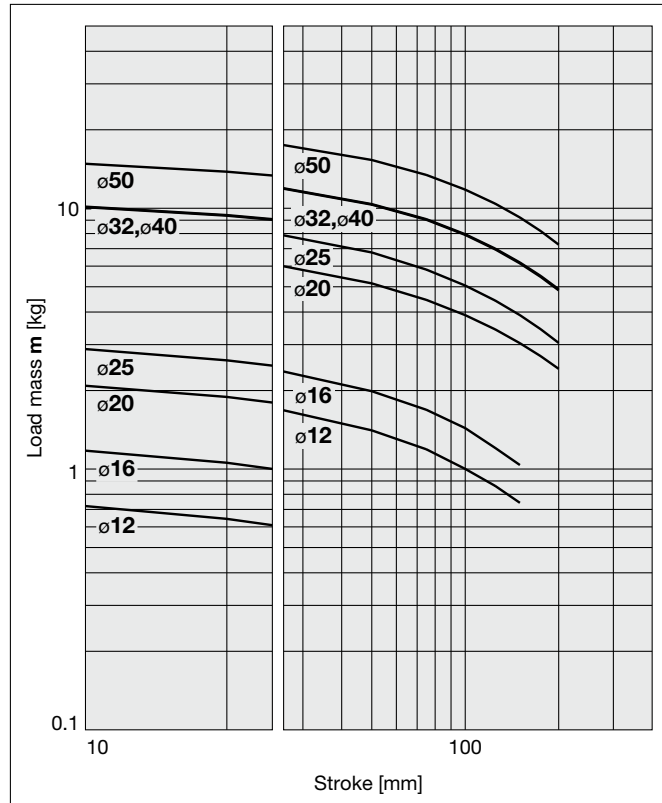

14 L = 100 mm, V = 200 mm/s or less

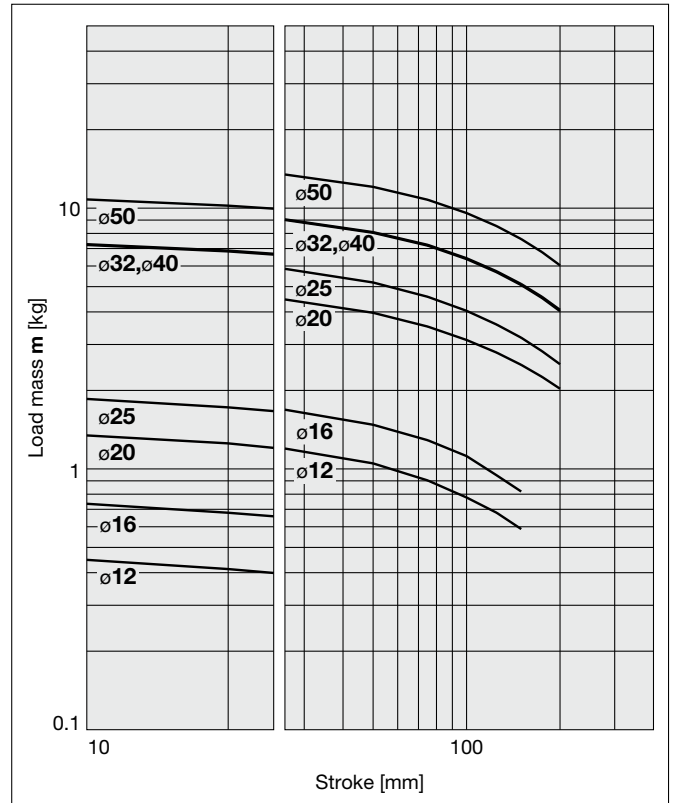

15 L = 50 mm, V = 400 mm/s

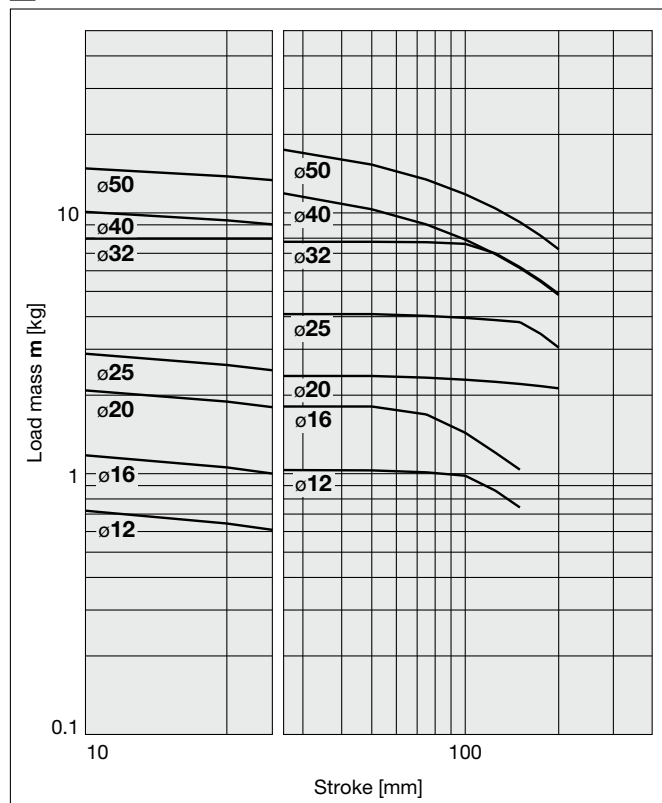

16 L = 100 mm, V = 400 mm/s

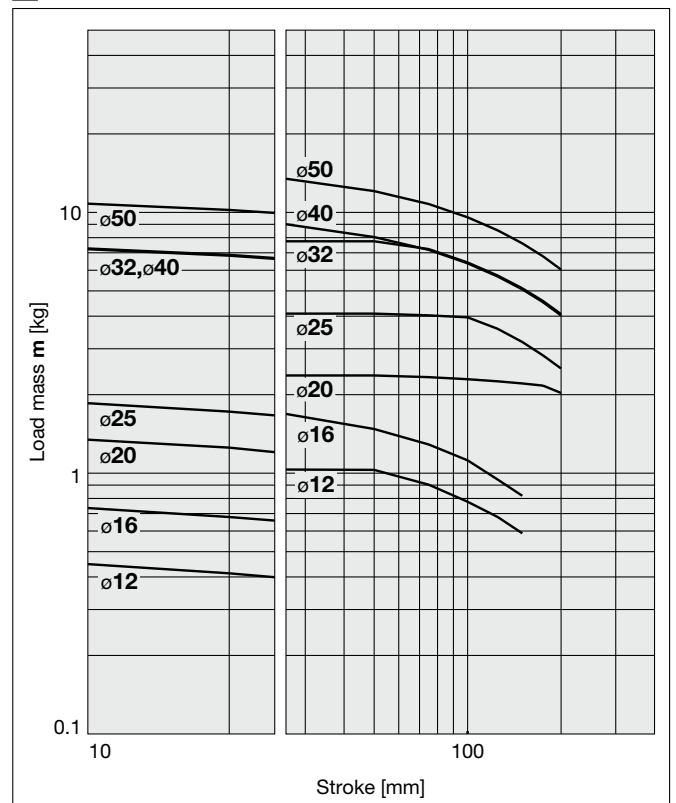

Operating Range when Used as a Stopper

MGPK□M12 to 25

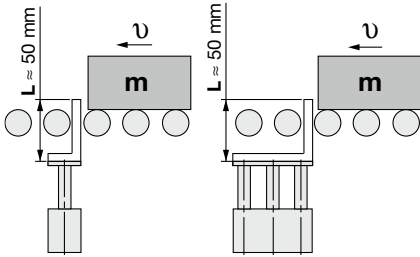

* When selecting a model with a longer **L** dimension, be sure to choose a bore size which is sufficiently large.

Caution

Handling Precautions

1. When used as a stopper, select a model with a stroke of 30 mm or less.
2. The MGPKA (Plate material: Aluminum alloy) cannot be used as a stopper.

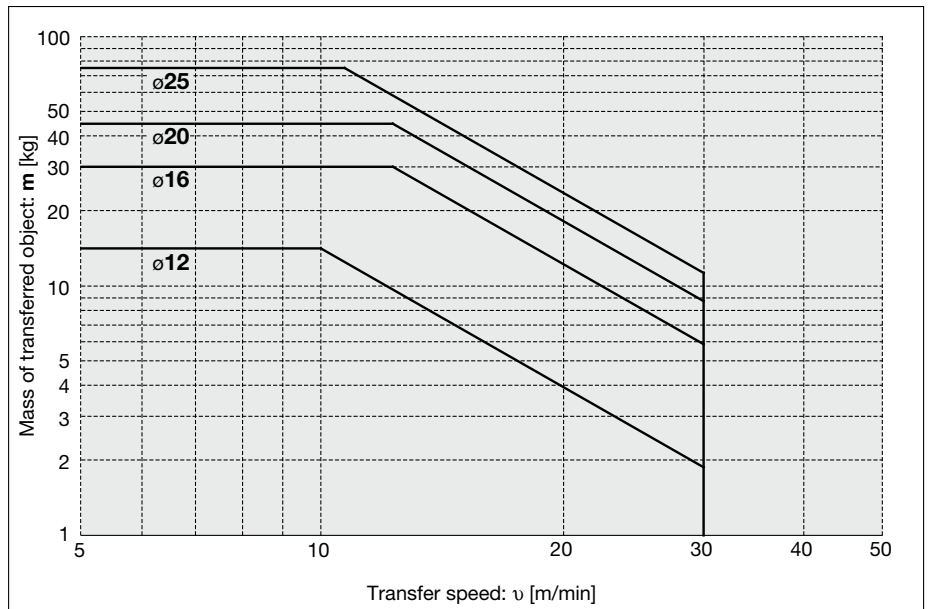

MGPK□M32 to 50

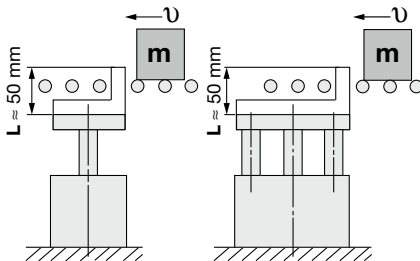

* When selecting a model with a longer **L** dimension, be sure to choose a bore size which is sufficiently large.

Caution

Handling Precautions

1. When used as a stopper, select a model with a stroke of 50 mm or less.
2. The MGPKA (Plate material: Aluminum alloy) cannot be used as a stopper.

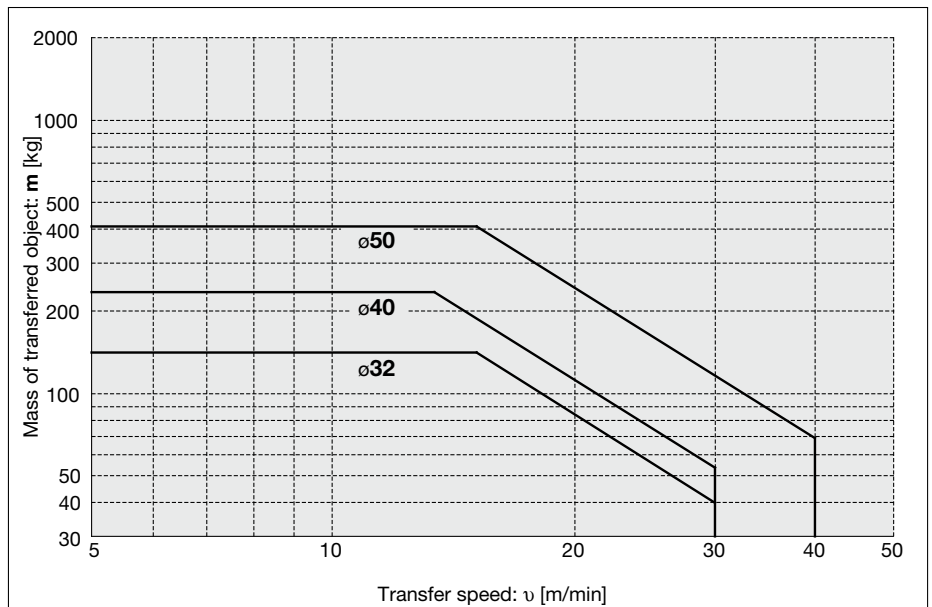

MGPK Series

Auto Switch Mounting

Auto Switch Proper Mounting Position (Detection at stroke end) and Mounting Height

D-M9□/M9□V
 D-M9□W/M9□WV
 D-M9□A/M9□AV
 D-A9□/A9□V

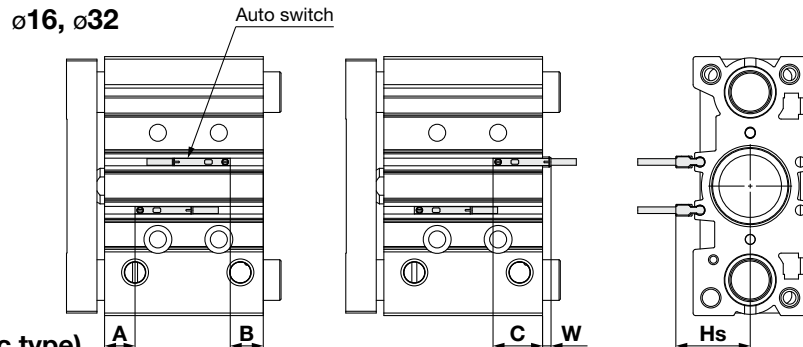

Applicable Cylinder: MGPK (Basic type)
 Auto Switch Proper Mounting Position

Auto switch model	D-M9□ D-M9□V								D-M9□W D-M9□WV								D-M9□A D-M9□AV								D-A9□ D-A9□V							
	Bore size	A	B		C		W		A	B		C		W		A	B		C		W											
			100 mm stroke or less	101 mm stroke or more	100 mm stroke or less	101 mm stroke or more	100 mm stroke or less	101 mm stroke or more		100 mm stroke or less	101 mm stroke or more	100 mm stroke or less	101 mm stroke or more	100 mm stroke or less	101 mm stroke or more		100 mm stroke or less	101 mm stroke or more	100 mm stroke or less	101 mm stroke or more												
12	7.5	7.5	10	19.5	22	4.5	2	3.5	3.5	6	23.5	26	1	—	—	—	—	—	—	—	—	—										
16	9	7.5	10.5	19.5	22.5	4.5	1.5	5	3.5	6.5	23.5	26.5	1	—	—	—	—	—	—	—	—											
20	13.5	13.5	15	25.5	27	—	—	9.5	9.5	11	29.5	31	—	—	—	—	—	—	—	—	—											
25	11.5	14	16.5	26	28.5	—	—	7.5	10	12.5	30	32.5	—	—	—	—	—	—	—	—	—											
32	12	13	15.5	25	27.5	—	—	8	9	11.5	29	31.5	—	—	—	—	—	—	—	—	—											
40	15	20	20	32	32	—	—	11	16	16	36	36	—	—	—	—	—	—	—	—	—											
50	14.5	21	21	33	33	—	—	10.5	17	17	37	37	—	—	—	—	—	—	—	—	—											

* The value of "W" in the table means the amount of auto switch protrusion from the body end surface.
 * Adjust the auto switch after confirming the operating conditions in the actual setting.

Applicable Cylinder: MGPK (Basic type)
 Auto Switch Mounting Height [mm]

Auto switch model	D-M9□V D-M9□WV D-M9□AV		D-A9□V
	Hs		Hs
12	19.7		17.2
16	21.5		19
20	23.2		20.7
25	24.7		22.2
32	29.5		27
40	31.2		28.7
50	34.5		32

Applicable Cylinder: MGPK-A (Air cushion)
 Auto Switch Proper Mounting Position [mm]

Auto switch model	D-M9□ D-M9□W D-M9□A			D-M9□V D-M9□WV D-M9□AV			D-A9□ D-A9□V		
	A	B	C	A	B	C	A	B	C
12	20	23	35	16	19	39	16	19	39
16	21	23.5	35.5	17	19.5	39.5	17	19.5	39.5
20	25	29	41	21	25	45	21	25	45
25	24	29.5	41.5	20	25.5	45.5	20	25.5	45.5
32	27.5	29.5	37.5	23.5	21.5	41.5	23.5	21.5	41.5
40	28.5	31.5	43.5	24.5	27.5	47.5	24.5	27.5	47.5
50	30.5	30.5	42.5	26.5	26.5	46.5	26.5	26.5	46.5

* Adjust the auto switch after confirming the operating conditions in the actual setting.

Applicable Cylinder: MGPK-A (Air cushion)
 Auto Switch Proper Mounting Position [mm]

Auto switch model	D-M9□V D-M9□WV D-M9□AV		D-A9□V
	Hs		Hs
12	19.7		17.2
16	21.5		19
20	23.2		20.7
25	24.7		22.2
32	29.5		27
40	31.2		28.7
50	34.5		32

Operating Range

Auto switch model	Bore size [mm]						
	12	16	20	25	32	40	50
D-M9□/M9□V D-M9□W/M9□WV D-M9□A/M9□AV	3.5	3.5	5	5	5.5	6	6
D-A9□/A9□V	7	9	9	9	9.5	9.5	9.5

* Values which include hysteresis are for reference purposes only. They are not a guarantee (assuming approximately ±30% dispersion) and may change substantially depending on the ambient environment.

Minimum Stroke for Auto Switch Mounting

Number of auto switches	[mm]	
	D-M9□(V)	D-M9□W(V) D-M9□A(V) D-A9□(V)
1	5	5
2	5	10

* If the stroke is short, be careful to ensure sufficient space for a lead wire.

Auto Switch Mounting

Applicable auto switches	D-M9□/M9□V D-M9□W/M9□WV D-M9□A/M9□AV D-A9□/A9□V
Bore size [mm]	ø12, ø16, ø20, ø25, ø32, ø40, ø50
Auto switch tightening torque	[N·m]
	Auto switch model
D-M9□(V) D-M9□W(V) D-A9□(V)	0.05 to 0.15
D-M9□A(V)	0.05 to 0.10

Safety Instructions

These safety instructions are intended to prevent hazardous situations and/or equipment damage. These instructions indicate the level of potential hazard with the labels of “**Caution**,” “**Warning**” or “**Danger**.” They are all important notes for safety and must be followed in addition to International Standards (ISO/IEC)*1), and other safety regulations.

 **Danger :** **Danger** indicates a hazard with a high level of risk which, if not avoided, will result in death or serious injury.

 **Warning:** **Warning** indicates a hazard with a medium level of risk which, if not avoided, could result in death or serious injury.

 **Caution:** **Caution** indicates a hazard with a low level of risk which, if not avoided, could result in minor or moderate injury.

*1) ISO 4414: Pneumatic fluid power - General rules and safety requirements for systems and their components
ISO 4413: Hydraulic fluid power - General rules and safety requirements for systems and their components
IEC 60204-1: Safety of machinery - Electrical equipment of machines - Part 1: General requirements
ISO 10218-1: Robots and robotic devices - Safety requirements for industrial robots - Part 1: Robots etc.

Warning

1. The compatibility of the product is the responsibility of the person who designs the equipment or decides its specifications.

Since the product specified here is used under various operating conditions, its compatibility with specific equipment must be decided by the person who designs the equipment or decides its specifications based on necessary analysis and test results. The expected performance and safety assurance of the equipment will be the responsibility of the person who has determined its compatibility with the product. This person should also continuously review all specifications of the product referring to its latest catalog information, with a view to giving due consideration to any possibility of equipment failure when configuring the equipment.

2. Only personnel with appropriate training should operate machinery and equipment.

The product specified here may become unsafe if handled incorrectly. The assembly, operation and maintenance of machines or equipment including our products must be performed by an operator who is appropriately trained and experienced.

3. Do not service or attempt to remove product and machinery/equipment until safety is confirmed.

1. The inspection and maintenance of machinery/equipment should only be performed after measures to prevent falling or runaway of the driven objects have been confirmed.
2. When the product is to be removed, confirm that the safety measures as mentioned above are implemented and the power from any appropriate source is cut, and read and understand the specific product precautions of all relevant products carefully.
3. Before machinery/equipment is restarted, take measures to prevent unexpected operation and malfunction.

4. Our products cannot be used beyond their specifications. Our products are not developed, designed, and manufactured to be used under the following conditions or environments. Use under such conditions or environments is not covered.

1. Conditions and environments outside of the given specifications, or use outdoors or in a place exposed to direct sunlight.
2. Use for nuclear power, railways, aviation, space equipment, ships, vehicles, military application, equipment affecting human life, body, and property, fuel equipment, entertainment equipment, emergency shut-off circuits, press clutches, brake circuits, safety equipment, etc., and use for applications that do not conform to standard specifications such as catalogs and operation manuals.
3. Use for interlock circuits, except for use with double interlock such as installing a mechanical protection function in case of failure. Please periodically inspect the product to confirm that the product is operating properly.

Caution

We develop, design, and manufacture our products to be used for automatic control equipment, and provide them for peaceful use in manufacturing industries.

Use in non-manufacturing industries is not covered.

Products we manufacture and sell cannot be used for the purpose of transactions or certification specified in the Measurement Act.

The new Measurement Act prohibits use of any unit other than SI units in Japan.

Limited warranty and Disclaimer/ Compliance Requirements

The product used is subject to the following “Limited warranty and Disclaimer” and “Compliance Requirements”.

Read and accept them before using the product.

Limited warranty and Disclaimer

1. The warranty period of the product is 1 year in service or 1.5 years after the product is delivered, whichever is first.*2)
Also, the product may have specified durability, running distance or replacement parts. Please consult your nearest sales branch.
2. For any failure or damage reported within the warranty period which is clearly our responsibility, a replacement product or necessary parts will be provided. This limited warranty applies only to our product independently, and not to any other damage incurred due to the failure of the product.
3. Prior to using SMC products, please read and understand the warranty terms and disclaimers noted in the specified catalog for the particular products.

*2) **Vacuum pads are excluded from this 1 year warranty.**

A vacuum pad is a consumable part, so it is warranted for a year after it is delivered.

Also, even within the warranty period, the wear of a product due to the use of the vacuum pad or failure due to the deterioration of rubber material are not covered by the limited warranty.

Compliance Requirements

1. The use of SMC products with production equipment for the manufacture of weapons of mass destruction (WMD) or any other weapon is strictly prohibited.
2. The exports of SMC products or technology from one country to another are governed by the relevant security laws and regulations of the countries involved in the transaction. Prior to the shipment of a SMC product to another country, assure that all local rules governing that export are known and followed.

Revision History

Edition B * Bore sizes $\phi 12$, $\phi 20$, $\phi 25$, $\phi 40$, and $\phi 50$ have been added. BP

Edition C * A ball bushing bearing type has been added. ($\phi 16$, $\phi 32$)

* Number of pages has been increased from 20 to 28.

Safety Instructions

Be sure to read the “Handling Precautions for SMC Products” (M-E03-3) and “Operation Manual” before use.

SMC Corporation

Akihabara UDX 15F,
4-14-1, Sotokanda, Chiyoda-ku, Tokyo 101-0021, JAPAN
Phone: 03-5207-8249 Fax: 03-5298-5362
<https://www.smcworld.com>
© 2024 SMC Corporation All Rights Reserved

Specifications are subject to change without prior notice and any obligation on the part of the manufacturer.

D-G