

3-Screen Display

New

Digital Flow Monitor



Can measure up to
12,000 L/min!

While checking the measured value,

Main screen Measured value (Current flow value)

settings are possible.

Sub screen
Left side Label (Display item)
Right side Accumulated flow, Set value (Threshold value)





Visualization of Settings

Accumulated flow	AC	Set value (Threshold value)	P.1
Hysteresis value	H.1	Bottom value	Lo
Peak value	H.1		

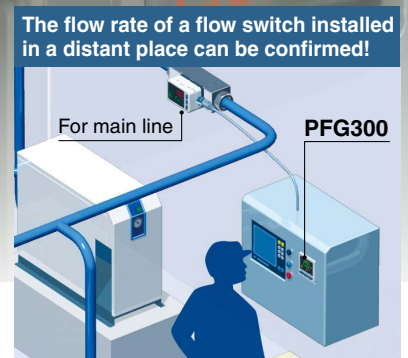
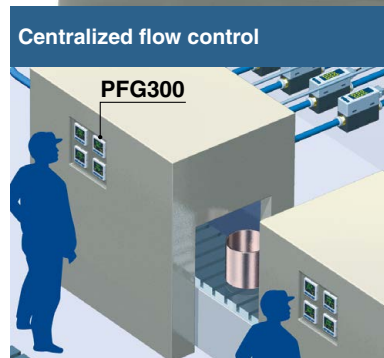
Current consumption
25 mA or less

Applicable Flow Switch Variations



Series	Smallest settable increment	Rated flow range [L/min]																													
		0.01	0.02	0.05	0.1	0.3	0.5	1	2	5	10	20	25	50	100	150	200	300	500	600	1000	2000	3000	6000	12000						
PF3A7□H 	2 L/min													30											3000						
	5 L/min													60											6000						
	10 L/min													120											12000						
PF2M7 	0.001 L/min	0.01														1															
		0.02														2															
	0.01 L/min	0.05														5															
		0.1														10															
		0.3														25															
0.1 L/min	0.5														50																
	1														100																
1 L/min	2														200																
PFMB 	1 L/min																														
PF2MC7(-L) 	1 L/min																														

PFG300 Series



P-E17-3 ©

Visualization of Settings

The sub screen (label) shows the item to be set.

New PFG300 **Current model**

Always displayed on one screen

Switches between displays

Mode Examples

Hysteresis mode

Normal output | Set value (Threshold value) | Reverse output | Set value (Threshold value) | Hysteresis | Set hysteresis value

Window comparator mode

Normal output/Lo side | Set value (Threshold value) | Normal output/Hi side | Set value (Threshold value) | Reverse output/Lo side | Set value (Threshold value) | Reverse output/Hi side | Set value (Threshold value)

Easy Screen Switching

It is possible to change the settings while checking the measured value.

Main screen
Measured value (Current flow value)

Sub screen/Left side
Label (Display item)

Sub screen/Right side
Set value (Threshold value)

The sub screen can be switched by pressing the up/down buttons.



* Either "Input of line name" or "Display OFF" can be added via the function settings.

NPN/PNP Switch Function

The number of stock items can be reduced.

Select NPN or PNP

NPN **PNP**

Input Range Selection (for Pressure/Flow rate)

The displayed value to the sensor input can be set as required.
(Voltage input: 1 to 5 V/Current input: 4 to 20 mA)

Pressure switch/Flow switch can be displayed.

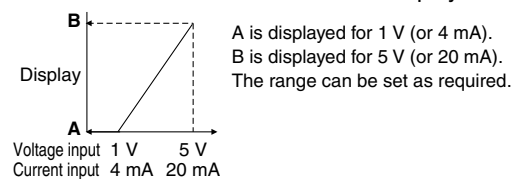

■ Pressure Sensor for General Fluids/PSE570

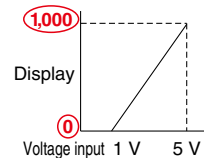

	A	B
PSE570	0	1,000
PSE573	-100	100
PSE574	0	500

Set A and B to the values shown in the table above.

Analog output of 0 to 10 V is also available.

Voltage output	1 to 5 V	Switchable
	0 to 10 V	
Current output	4 to 20 mA	Fixed

Functions

- Output operation
- Simple setting mode
- Display color
- Delay time setting
- Digital filter setting
- FUNC output switching function
- Selectable analog output function
- External input function
- Forced output function
- Accumulated value hold
- Peak/Bottom value display
- Setting of security code
- Keylock function
- Reset to the default settings
- Display with zero cut-off setting
- Selection of display on sub screen
- Analog output free range function
- Error display function
- Copy function
- Power-saving mode

Simple 3-Step Setting

When the S button is pressed and the set value (P_1) is being displayed, the set value (threshold value) can be set. When the S button is pressed and the hysteresis (H_1) is being displayed, the hysteresis value can be set.

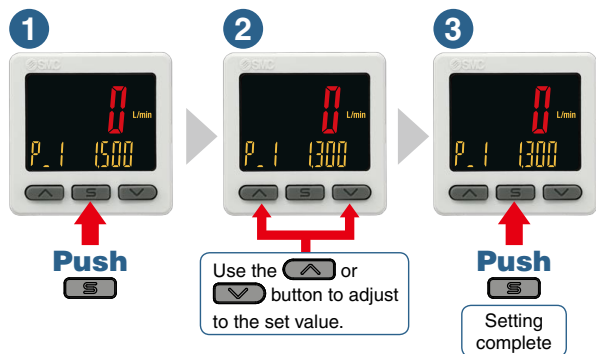

With a snap shot function for set value reading

Pressing the \uparrow and \downarrow buttons simultaneously for a minimum of 1 second will make the set value (threshold value) the same as the current flow value.

Snap shot function

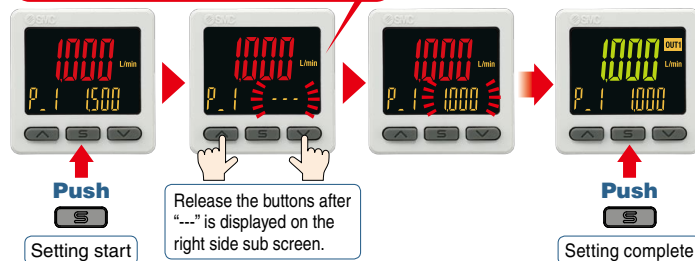

Convenient Functions

● Copy function

The settings of the master monitor can be copied to the slave monitors.

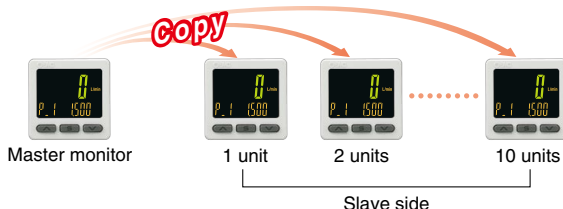

● Secret code setting function

The key locking function keeps unauthorized persons from tampering with the settings.

● Power-saving function

Power consumption is reduced by turning off the monitor.

Current consumption*1	Reduction rate*2
25 mA or less	Approx. 50% reduction

*1 During normal operation *2 In power-saving mode

● External input function

The accumulated value, peak value, and bottom value can be reset remotely.

Compact & Lightweight

- Compact: Max. 6 mm shorter
- Lightweight: Max. 5 g lighter (30 g → 25 g)

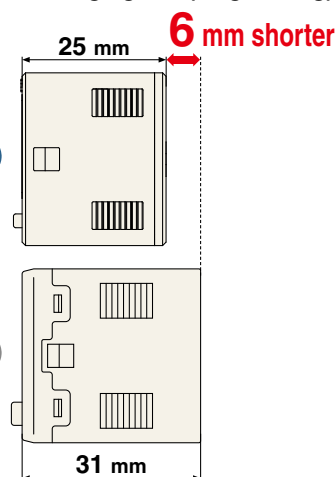

Mounting

Bracket configuration allows for mounting in four orientations.

Bracket A

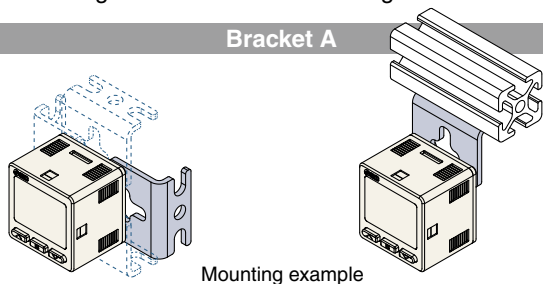

Bracket B

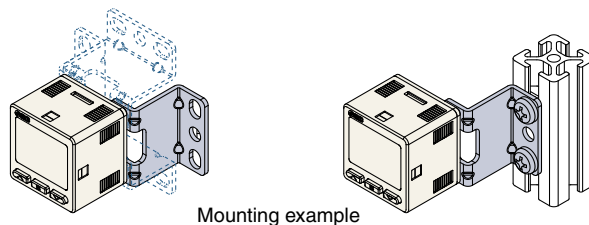

Panel mount

Mountable side by side without clearance

One opening!

- Reduced panel fitting labor
- Space saving

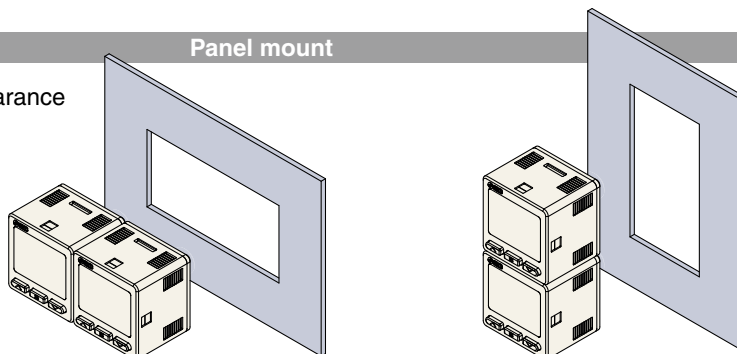

3-Screen Display

Digital Flow Monitor

PFG300 Series



How to Order

PFG 3 0 0 - RT - M - L

Type

3 Remote type monitor unit

Input specification

Symbol	Description
0	Voltage input
1	Current input

* The PFG3 (monitor unit) cannot be used as an IO-Link communication device.

Output specification

RT	2 outputs (NPN/PNP switching type) + Analog voltage output*1, 2
SV	2 outputs (NPN/PNP switching type) + Analog current output*2
XY	2 outputs (NPN/PNP switching type) + Copy function

*1 Can switch between 1 to 5 V and 0 to 10 V

*2 Can be switched to external input or copy function

Unit specification

Nil	Units selection function*3
M	SI units only*4

*3 This product is for overseas use only. (The SI unit type is provided for use in Japan in accordance with the New Measurement Act.)

*4 Fixed units: Instantaneous flow: L/min
Accumulated flow: L

Option 4

	Operation manual	Calibration certificate
Nil	○	—
Y	—	—
K	○	○
T	—	○

Option 3

Symbol	Description
Nil	None
C	ZS-28-CA-4/PF3A□H, PF2MC Sensor connector
F	ZS-28-C-1/PFMB Sensor connector

Option 1

Symbol	Description
Nil	Without lead wire
L	Power supply/output connection lead wire (Lead wire length: 2 m) ZS-46-5L Power supply/output connection lead wire

Option 2

Symbol	Description
Nil	None
A1	Bracket A (Vertical mounting) ZS-46-A1
A2	Bracket B (Horizontal mounting) ZS-46-A2
B	Panel mount adapter ZS-46-B
D	Panel mount adapter + Front protection cover ZS-46-D

Options/Part Nos.

When only optional parts are required, order with the part numbers listed below.

Part no.	Option	Note
ZS-28-CA-4	Sensor connector	For PF3A□H For PF2MC
ZS-28-C-1	Sensor connector	For PFMB
ZS-46-A1	Bracket A	Tapping screw: Nominal size 3 x 8 L (2 pcs.)
ZS-46-A2	Bracket B	Tapping screw: Nominal size 3 x 8 L (2 pcs.)
ZS-46-B	Panel mount adapter	
ZS-46-D	Panel mount adapter + Front protection cover	
ZS-46-5L	Power supply/output connection lead wire	5-core, 2 m
ZS-27-01	Front protection cover	

Connection Example/For PF3A7□H(-L)

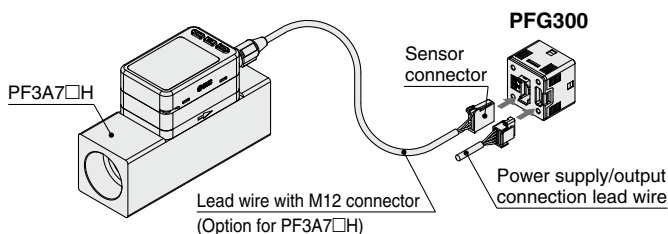

For flow switch precautions and specific product precautions, refer to the "Operation Manual" on the SMC website.

Specifications/For PF3A□H(-L)

Model		PFG300 series						
Applicable SMC flow switch	Model	PF3A701H	PF3A702H	PF3A703H	PF3A706H	PF3A712H		
	Rated flow range *1	10 to 1000 L/min	20 to 2000 L/min	30 to 3000 L/min	60 to 6000 L/min	120 to 12000 L/min		
Flow	Set point range	Instantaneous flow	-50 to 1050 L/min	-100 to 2100 L/min	-150 to 3150 L/min	-300 to 6300 L/min	-600 to 12600 L/min	
		Accumulated flow	0 to 999,999,999,990 L		0 to 999,999,999,990 L		0 to 999,999,999,990 L	
	Smallest settable increment	Instantaneous flow	1 L/min		2 L/min		5 L/min	
		Accumulated flow	10 L		10 L		100 L	
	Accumulated volume per pulse (Pulse width = 50 ms)	10 L/pulse		10 L/pulse		100 L/pulse		
	Accumulated value hold function *3	Intervals of 2 or 5 minutes can be selected. The stored accumulated flow is held even when the power supply is OFF.						
Electrical	Power supply voltage	12 to 24 VDC ±10% (24 VDC when the PF3A7□H is connected)						
	Current consumption	25 mA or less						
	Protection	Polarity protection						
Accuracy	Display accuracy	±0.5% F.S. ± Minimum display unit (Ambient temperature of 25°C)						
	Analog output accuracy	±0.5% F.S. (Ambient temperature of 25°C)						
	Repeatability	±0.1% F.S. ± Minimum display unit						
	Temperature characteristics	±0.5% F.S. (Ambient temperature: 0 to 50°C, 25°C standard)						
Switch output	Output type	Select from NPN or PNP open collector output.						
	Output mode	Select from Hysteresis, Window comparator, Accumulated output, Accumulated pulse output, Error output, or Switch output OFF modes.						
	Switch operation	Select from Normal or Reversed output.						
	Max. load current	80 mA						
	Max. applied voltage (NPN only)	30 VDC						
	Internal voltage drop (Residual voltage)	NPN output: 1 V or less (at load current of 80 mA), PNP output: 1.5 V or less (at load current of 80 mA)						
	Response time *2	3 ms or less						
	Delay time *2	Select from 0.00, 0.05 to 0.1 s (increment of 0.01 s), 0.1 to 1.0 s (increment of 0.1 s), 1 to 10 s (increment of 1 s), 20 s, 30 s, 40 s, 50 s, or 60 s.						
	Hysteresis *4	Variable from 0						
Analog output*5	Protection	Short circuit protection						
	Output type	Voltage output: 1 to 5 V, 0 to 10 V (only when the power supply voltage is 24 VDC) Current output: 4 to 20 mA (0 L/min to maximum value of the rated flow)						
	Impedance	Voltage output	Output impedance: 1 kΩ					
		Current output	Maximum load impedance: 300 Ω (at power supply voltage of 12 V), 600 Ω (at power supply voltage of 24 VDC)					
	Response time *2	50 ms or less						
External input*6	External input	Input voltage: 0.4 V or less (Reed or Solid state) for 30 ms or longer						
	Input mode	Select from Accumulated value external reset or Peak/Bottom value reset.						
Sensor input	Input type	Voltage input: 1 to 5 VDC (Input impedance: 1 MΩ), Current input: 4 to 20 mA DC (Input impedance: 51 Ω) (0 L/min to maximum value of the rated flow)						
	Connection method	Connector (e-CON)						
	Protection	Over voltage protection (Up to 26.4 VDC)						
Display	Display mode	Select from Instantaneous flow or Accumulated flow.						
	Unit *7	Instantaneous flow	L/min, cfm (ft ³ /min)					
		Accumulated flow	L, ft ³ , L x 10 ⁶ , ft ³ x 10 ⁶					
	Display range	Instantaneous flow	-50 to 1050 L/min	-100 to 2100 L/min	-150 to 3150 L/min	-300 to 6300 L/min	-600 to 12600 L/min	
		Accumulated flow*9	0 to 999,999,999,990 L		0 to 999,999,999,990 L		0 to 999,999,999,990 L	
	Minimum display unit	Instantaneous flow	1 L/min		2 L/min		5 L/min	
		Accumulated flow	10 L		10 L		100 L	
	Display type	LCD						
	Number of displays	3-screen display (Main screen, Sub screen)						
Display color	1) Main screen: Red/Green, 2) Sub screen: Orange							
Number of display digits	1) Main screen: 5 digits (7 segments), 2) Sub screen: 9 digits (7 segments)							
Indicator LED	LED ON when switch output is ON. OUT1/2: Orange							
Digital filter*8	Select from 0.00, 0.05 to 0.1 s (increment of 0.01 s), 0.1 to 1.0 s (increment of 0.1 s), 1 to 10 s (increment of 1 s), 20 s, or 30 s.							
Environment	Enclosure	IP40						
	Withstand voltage	1000 VAC for 1 minute between terminals and housing						
	Insulation resistance	50 MΩ or more (500 VDC measured via megohmmeter) between terminals and housing						
	Operating temperature range	Operating: 0 to 50°C, Stored: -10 to 60°C (No condensation or freezing)						
Operating humidity range	Operating/Stored: 35 to 85% RH (No condensation or freezing)							
Standards	CE/UKCA marking							
Weight	Body	25 g (Excluding the power supply/output connection lead wire)						
	Lead wire with connector	+39 g						

*1 Rated flow range of the applicable flow switch

*2 Value without digital filter (at 0.00 s)

*3 When using the accumulated value hold function, use the operating conditions to calculate the product life, and do not exceed it. The maximum access limit of the memory device is 1.5 million times. If the product is operated 24 hours per day, the product life will be as follows:

- 5 min interval: life is calculated as 5 min x 1.5 million = 7.5 million min = 14.3 years
- 2 min interval: life is calculated as 2 min x 1.5 million = 3 million min = 5.7 years

If the accumulated value external reset is repeatedly used, the product life will be shorter than the calculated life.

*4 If the flow fluctuates around the set value, the width for setting more than the fluctuating width needs to be set. Otherwise, chattering will occur.

*5 Setting is only possible for models with analog output.

*6 Setting is only possible for models with external input.

*7 Setting is only possible for models with the units selection function.

*8 The response time indicates when the set value is 90% in relation to the step input.

*9 The accumulated flow display is the upper 6-digit and lower 6-digit (total of 12 digits) display. When the upper digits are displayed, x 10⁶ lights up.

* Products with tiny scratches, marks, or display color or brightness variations which do not affect the performance of the product are verified as conforming products.

PFG300 Series

For flow switch precautions and specific product precautions, refer to the "Operation Manual" on the SMC website. Click [here](#) for details.

Specifications/For PFMB

Model		PFG300 series			
Applicable SMC flow switch	Model	PFMB7501	PFMB7102	PFMB7202	
	Rated flow range *1	5 to 500 L/min	10 to 1000 L/min	20 to 2000 L/min	
Flow	Set point range	Instantaneous flow	-25 to 525 L/min	-50 to 1050 L/min	
		Accumulated flow	0 to 999,999,999,990 L		
	Smallest settable increment	Instantaneous flow	1 L/min		
		Accumulated flow	10 L		
	Accumulated volume per pulse (Pulse width = 50 ms)	1 L/pulse		10 L/pulse	
	Accumulated value hold function *3	Intervals of 2 or 5 minutes can be selected. The stored accumulated flow is held even when the power supply is OFF.			
Electrical	Power supply voltage	12 to 24 VDC ±10%			
	Current consumption	25 mA or less			
	Protection	Polarity protection			
Accuracy	Display accuracy	±0.5% F.S. ± Minimum display unit (Ambient temperature of 25°C)			
	Analog output accuracy	±0.5% F.S. (Ambient temperature of 25°C)			
	Repeatability	±0.1% F.S. ±1 digit			
	Temperature characteristics	±0.5% F.S. (Ambient temperature: 0 to 50°C, 25°C standard)			
Switch output	Output type	Select from NPN or PNP open collector output.			
	Output mode	Select from Hysteresis, Window comparator, Accumulated output, Accumulated pulse output, Error output, or Switch output OFF modes.			
	Switch operation	Select from Normal or Reversed output.			
	Max. load current	80 mA			
	Max. applied voltage (NPN only)	30 VDC			
	Internal voltage drop (Residual voltage)	NPN output: 1 V or less (at load current of 80 mA), PNP output: 1.5 V or less (at load current of 80 mA)			
	Response time *2	3 ms or less			
	Delay time *2	Select from 0.00, 0.05 to 0.1 s (increment of 0.01 s), 0.1 to 1.0 s (increment of 0.1 s), 1 to 10 s (increment of 1 s), 20 s, 30 s, 40 s, 50 s, or 60 s			
	Hysteresis *4	Variable from 0			
	Protection	Short circuit protection			
Analog output*5	Output type	Voltage output: 1 to 5 V, 0 to 10 V (only when the power supply voltage is 24 VDC) Current output: 4 to 20 mA (0 L/min to maximum value of the rated flow)			
	Impedance	Voltage output	Output impedance: 1 kΩ		
		Current output	Maximum load impedance: 300 Ω (at power supply voltage of 12 V), 600 Ω (at power supply voltage of 24 VDC)		
	Response time *2	50 ms or less			
External input*6	External input	Input voltage: 0.4 V or less (Reed or Solid state) for 30 ms or longer			
	Input mode	Select from Accumulated value external reset or Peak/Bottom value reset.			
Sensor input	Input type	Voltage input: 1 to 5 VDC (Input impedance: 1 MΩ), Current input: 4 to 20 mA DC (Input impedance: 51 Ω) (0 L/min to maximum value of the rated flow)			
	Connection method	Connector (e-CON)			
	Protection	Over voltage protection (Up to 26.4 VDC)			
Display	Display mode	Select from Instantaneous flow or Accumulated flow.			
	Unit *7	Instantaneous flow	L/min, cfm (ft ³ /min)		
		Accumulated flow	L, ft ³ , L x 10 ⁶ , ft ³ x 10 ⁶		
	Display range	Instantaneous flow	-25 to 525 L/min	-50 to 1050 L/min	-100 to 2100 L/min
		Accumulated flow*9	0 to 999,999,999,990 L		
	Minimum display unit	Instantaneous flow	1 L/min		
		Accumulated flow	10 L		
	Display type	LCD			
	Number of displays	3-screen display (Main screen, Sub screen)			
Display color	1) Main screen: Red/Green, 2) Sub screen: Orange				
Number of display digits	1) Main screen: 5 digits (7 segments), 2) Sub screen: 9 digits (7 segments)				
Indicator LED	LED ON when switch output is ON OUT1/2: Orange				
Digital filter*8	Select from 0.00, 0.05 to 0.1 s (increment of 0.01 s), 0.1 to 1.0 s (increment of 0.1 s), 1 to 10 s (increment of 1 s), 20 s, or 30 s				
Environment	Enclosure	IP40			
	Withstand voltage	1000 VAC for 1 minute between terminals and housing			
	Insulation resistance	50 MΩ or more (500 VDC measured via megohmmeter) between terminals and housing			
	Operating temperature range	Operating: 0 to 50°C, Stored: -10 to 60°C (No condensation or freezing)			
	Operating humidity range	Operating/Stored: 35 to 85% RH (No condensation or freezing)			
Standards	CE/UKCA marking				
Weight	Body	25 g (Excluding the power supply/output connection lead wire)			
	Lead wire with connector	+39 g			

*1 Rated flow range of the applicable flow switch

*2 Value without digital filter (at 0.00 s)

*3 When using the accumulated value hold function, use the operating conditions to calculate the product life, and do not exceed it. The maximum access limit of the memory device is 1.5 million times. If the product is operated 24 hours per day, the product life will be as follows:

- 5 min interval: life is calculated as 5 min x 1.5 million = 7.5 million min = 14.3 years
- 2 min interval: life is calculated as 2 min x 1.5 million = 3 million min = 5.7 years

If the accumulated value external reset is repeatedly used, the product life will be shorter than the calculated life.

*4 If the flow fluctuates around the set value, the width for setting more than the fluctuating width needs to be set. Otherwise, chattering will occur.

*5 Setting is only possible for models with analog output.

*6 Setting is only possible for models with external input.

*7 Setting is only possible for models with the units selection function.

*8 The response time indicates when the set value is 90% in relation to the step input.

*9 The accumulated flow display is the upper 6-digit and lower 6-digit (total of 12 digits) display. When the upper digits are displayed, x 10⁶ lights up.

* Products with tiny scratches, marks, or display color or brightness variations which do not affect the performance of the product are verified as conforming products.



For flow switch precautions and specific product precautions, refer to the "Operation Manual" on the SMC website.

Specifications/For PF2MC

Model		PFG300 series			
Applicable SMC flow switch	Model	PF2MC7501	PF2MC7102	PF2MC7202	
	Rated flow range*1	5 to 500 L/min	10 to 1000 L/min	20 to 2000 L/min	
Flow	Set point range	Instantaneous flow	-25 to 525 L/min	-50 to 1050 L/min	-100 to 2100 L/min
		Accumulated flow	0 to 999,999,999,990 L		
	Smallest settable increment	Instantaneous flow	1 L/min		
		Accumulated flow	10 L		
	Accumulated volume per pulse (Pulse width = 50 ms)	1 L/pulse		10 L/pulse	
Accumulated value hold function*3	Intervals of 2 or 5 minutes can be selected. The stored accumulated flow is held even when the power supply is OFF.				
Electrical	Power supply voltage	12 to 24 VDC ±10%			
	Current consumption	25 mA or less			
	Protection	Polarity protection			
Accuracy	Display accuracy	±0.5% F.S. ± Min. display unit (Ambient temperature at 25°C)			
	Analog output accuracy	±0.5% F.S. (Ambient temperature at 25°C)			
	Repeatability	±0.1% F.S. ±1 digit			
	Temperature characteristics	±0.5% F.S. (Ambient temperature: 0 to 50°C, 25°C standard)			
Switch output	Output type	Select from NPN or PNP open collector output.			
	Output mode	Select from Hysteresis, Window comparator, Accumulated output, Accumulated pulse output, Error output, or Switch output OFF modes.			
	Switch operation	Select from Normal or Reversed output.			
	Max. load current	80 mA			
	Max. applied voltage (NPN only)	30 VDC			
	Internal voltage drop (Residual voltage)	NPN output: 1 V or less (at load current of 80 mA), PNP output: 1.5 V or less (at load current of 80 mA)			
	Response time*2	3 ms or less			
	Delay time*2	Select from 0.00, 0.05 to 0.1 s (increments of 0.01 s), 0.1 to 1.0 s (increments of 0.1 s), 1 to 10 s (increments of 1 s), 20 s, 30 s, 40 s, 50 s, or 60 s.			
	Hysteresis*4	Variable from 0			
Analog output*5	Protection	Short circuit protection			
	Output type	Voltage output: 1 to 5 V, 0 to 10 V (only when the power supply voltage is 24 VDC) Current output: 4 to 20 mA (0 L/min to max. value of the rated flow)			
	Impedance	Voltage output	Output impedance: 1 kΩ		
		Current output	Max. load impedance: 300 Ω (at power supply voltage of 12 V), 600 Ω (at power supply voltage of 24 VDC)		
Response time*2	50 ms or less				
External input*6	External input	Input voltage: 0.4 V or less (Reed or Solid state) for 30 ms or longer			
	Input mode	Select from Accumulated value external reset or Peak/Bottom value reset.			
Sensor input	Input type	Voltage input: 1 to 5 VDC (Input impedance: 1 MΩ), Current input: 4 to 20 mA DC (Input impedance: 51 Ω) (0 L/min to max. value of the rated flow)			
	Connection method	Connector (e-CON)			
	Protection	Over voltage protection (Up to 26.4 VDC)			
Display	Display mode	Select from Instantaneous flow or Accumulated flow.			
	Unit*7	Instantaneous flow	L/min, cfm (ft ³ /min)		
		Accumulated flow	L, ft ³ , L x 10 ⁶ , ft ³ x 10 ⁶		
	Display range	Instantaneous flow	-25 to 525 L/min	-50 to 1050 L/min	-100 to 2100 L/min
		Accumulated flow*9	0 to 999,999,999,990 L		
	Min. display unit	Instantaneous flow	1 L/min		
		Accumulated flow	10 L		
	Display type	LCD			
	Number of displays	3-screen display (Main screen, Sub screen)			
	Display color	1) Main screen: Red/Green, 2) Sub screen: Orange			
Number of display digits	1) Main screen: 5 digits (7 segments), 2) Sub screen: 9 digits (7 segments)				
Indicator LED	LED ON when switch output is ON. OUT1/2: Orange				
Digital filter*8	Select from 0.00, 0.05 to 0.1 s (increments of 0.01 s), 0.1 to 1.0 s (increments of 0.1 s), 1 to 10 s (increments of 1 s), 20 s, or 30 s.				
Environmental resistance	Enclosure	IP40			
	Withstand voltage	1000 VAC for 1 min between terminals and housing			
	Insulation resistance	50 MΩ or more (500 VDC measured via megohmmeter) between terminals and housing			
	Operating temperature range	Operating: 0 to 50°C, Stored: -10 to 60°C (No condensation or freezing)			
Standards	Operating/Stored: 35 to 85% RH (No condensation or freezing)				
Weight	CE/UKCA marking				
	Body	25 g (Excluding the power supply/output connection lead wire)			
	Lead wire with connector	+39 g			

*1 Rated flow range of the applicable flow switch
 *2 Value without digital filter (at 0.00 s)
 *3 When using the accumulated value hold function, use the operating conditions to calculate the product life, and do not exceed it. The max. access limit of the memory device is 1.5 million times. If the product is operated 24 hours per day, the product life will be as follows:
 • 5 min interval: life is calculated as 5 min x 1.5 million = 7.5 million min = 14.3 years
 • 2 min interval: life is calculated as 2 min x 1.5 million = 3 million min = 5.7 years
 If the accumulated value external reset is repeatedly used, the product life will be shorter than the calculated life.
 *4 If the flow fluctuates around the set value, be sure to keep a sufficient margin. Otherwise, chattering will occur.
 *5 Setting is only possible for models with analog output.
 *6 Setting is only possible for models with external input.
 *7 Setting is only possible for models with the unit selection function.
 *8 The response time indicates when the set value is 90% in relation to the step input.
 *9 The accumulated flow display is the upper 6-digit and lower 6-digit (total of 12 digits) display. When the upper digits are displayed, x 10⁶ lights up.
 * Products with tiny scratches, marks, or display color or brightness variations which do not affect the performance of the product are verified as conforming products.

PFG300 Series

For flow switch precautions and specific product precautions, refer to the "Operation Manual" on the SMC website. Click [here](#) for details.

Specifications

Model		PFG300 series								
Applicable SMC flow switch	Model	PF2M701	PF2M702	PF2M705	PF2M710	PF2M725	PF2M750	PF2M711	PF2M721	
	Rated flow range *1	0.01 to 1 L/min	0.02 to 2 L/min	0.05 to 5 L/min	0.1 to 10 L/min	0.3 to 25 L/min	0.5 to 50 L/min	1 to 100 L/min	2 to 200 L/min	
Flow	Set point range	Instantaneous flow	-0.05 to 1.05 L/min	-0.1 to 2.1 L/min	-0.25 to 5.25 L/min	-0.5 to 10.5 L/min	-1.3 to 26.3 L/min	-2.5 to 52.5 L/min	-5 to 105 L/min	-10 to 210 L/min
		Accumulated flow	0 to 99,999,999,999.9 L				0 to 999,999,999,999 L			
	Smallest settable increment	Instantaneous flow	0.01 L/min				0.1 L/min		1 L/min	
		Accumulated flow	0.1 L				1 L			
	Accumulated volume per pulse (Pulse width = 50 ms)	0.1 L/pulse						1 L/pulse		
	Accumulated value hold function *3	Intervals of 2 or 5 minutes can be selected. The stored accumulated flow is held even when the power supply is OFF.								
Electrical	Power supply voltage	12 to 24 VDC ±10%								
	Current consumption	25 mA or less								
	Protection	Polarity protection								
Accuracy	Display accuracy	±0.5% F.S. ± Minimum display unit (Ambient temperature of 25°C)								
	Analog output accuracy	±0.5% F.S. (Ambient temperature of 25°C)								
	Repeatability	±0.1% F.S. ±1 digit								
	Temperature characteristics	±0.5% F.S. (Ambient temperature: 0 to 50°C, 25°C standard)								
Switch output	Output type	Select from NPN or PNP open collector output.								
	Output mode	Select from Hysteresis, Window comparator, Accumulated output, Accumulated pulse output, Error output, or Switch output OFF modes.								
	Switch operation	Select from Normal or Reversed output.								
	Max. load current	80 mA								
	Max. applied voltage (NPN only)	30 VDC								
	Internal voltage drop (Residual voltage)	NPN output: 1 V or less (at load current of 80 mA), PNP output: 1.5 V or less (at load current of 80 mA)								
	Response time *2	3 ms or less								
	Delay time *2	Select from 0.00, 0.05 to 0.1 s (increment of 0.01 s), 0.1 to 1.0 s (increment of 0.1 s), 1 to 10 s (increment of 1 s), 20 s, 30 s, 40 s, 50 s, or 60 s								
	Hysteresis *4	Variable from 0								
	Protection	Short circuit protection								
Analog output*5	Output type	Voltage output: 1 to 5 V, 0 to 10 V (only when the power supply voltage is 24 VDC) Current output: 4 to 20 mA (0 L/min to maximum value of the rated flow)								
	Impedance	Voltage output	Output impedance: 1 kΩ							
		Current output	Maximum load impedance: 300 Ω (at power supply voltage of 12 V), 600 Ω (at power supply voltage of 24 VDC)							
	Response time *2	50 ms or less								
External input*6	External input	Input voltage: 0.4 V or less (Reed or Solid state) for 30 ms or longer								
	Input mode	Select from Accumulated value external reset or Peak/Bottom value reset.								
Sensor input	Input type	Voltage input: 1 to 5 VDC (Input impedance: 1 MΩ), Current input: 4 to 20 mA DC (Input impedance: 51 Ω) (0 L/min to maximum value of the rated flow)								
	Connection method	Connector (e-CON)								
	Protection	Over voltage protection (Up to 26.4 VDC)								
Display	Display mode	Select from Instantaneous flow or Accumulated flow.								
	Unit *7	Instantaneous flow	L/min, cfm (ft ³ /min)							
		Accumulated flow	L, ft ³ , L x 10 ⁶ , ft ³ x 10 ⁶							
	Display range	Instantaneous flow	-0.05 to 1.05 L/min	-0.1 to 2.1 L/min	-0.25 to 5.25 L/min	-0.5 to 10.5 L/min	-1.3 to 26.3 L/min	-2.5 to 52.5 L/min	-5 to 105 L/min	-10 to 210 L/min
		Accumulated flow*9	0 to 99,999,999,999.9 L				0 to 999,999,999,999 L			
	Minimum display unit	Instantaneous flow	0.01 L/min				0.1 L/min		1 L/min	
		Accumulated flow	0.1 L				1 L			
	Display type	LCD								
Number of displays	3-screen display (Main screen, Sub screen)									
Display color	1) Main screen: Red/Green, 2) Sub screen: Orange									
Number of display digits	1) Main screen: 5 digits (7 segments), 2) Sub screen: 9 digits (7 segments)									
Indicator LED	LED ON when switch output is ON OUT1/2: Orange									
Digital filter*8	Select from 0.00, 0.05 to 0.1 s (increment of 0.01 s), 0.1 to 1.0 s (increment of 0.1 s), 1 to 10 s (increment of 1 s), 20 s, or 30 s									
Environment	Enclosure	IP40								
	Withstand voltage	1000 VAC for 1 minute between terminals and housing								
	Insulation resistance	50 MΩ or more (500 VDC measured via megohmmeter) between terminals and housing								
	Operating temperature range	Operating: 0 to 50°C, Stored: -10 to 60°C (No condensation or freezing)								
Operating humidity range	Operating/Stored: 35 to 85% RH (No condensation or freezing)									
Standards	CE/UKCA marking (EMC directive/RoHS directive)									
Weight	Body	25 g (Excluding the power supply/output connection lead wire)								
	Lead wire with connector	+39 g								

*1 Rated flow range of the applicable flow switch

*2 Value without digital filter (at 0.00 s)

*3 When using the accumulated value hold function, use the operating conditions to calculate the product life, and do not exceed it. The maximum access limit of the memory device is 1.5 million times. If the product is operated 24 hours per day, the product life will be as follows:

• 5 min interval: life is calculated as 5 min x 1.5 million = 7.5 million min = 14.3 years

• 2 min interval: life is calculated as 2 min x 1.5 million = 3 million min = 5.7 years

If the accumulated value external reset is repeatedly used, the product life will be shorter than the calculated life.

*4 If the flow fluctuates around the set value, the width for setting more than the fluctuating width needs to be set. Otherwise, chattering will occur.

*5 Setting is only possible for models with analog output.

*6 Setting is only possible for models with external input.

*7 Setting is only possible for models with the units selection function.

*8 The response time indicates when the set value is 90% in relation to the step input.

*9 The accumulated flow display is the upper 6-digit and lower 6-digit (total of 12 digits) display. When the upper digits are displayed, x 10⁶ lights up.

* Products with tiny scratches, marks, or display color or brightness variations which do not affect the performance of the product are verified as conforming products.

Internal Circuits and Wiring Examples

**-XY
-RT
-SV
NPN (2 outputs) + Copy function**

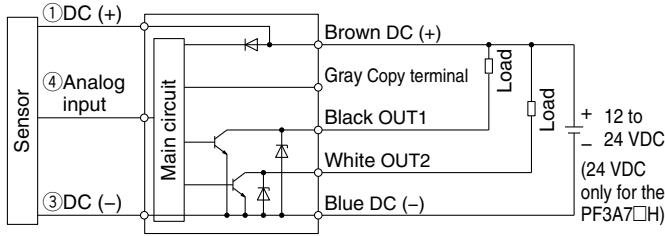

**-XY
-RT
-SV
PNP (2 outputs) + Copy function**

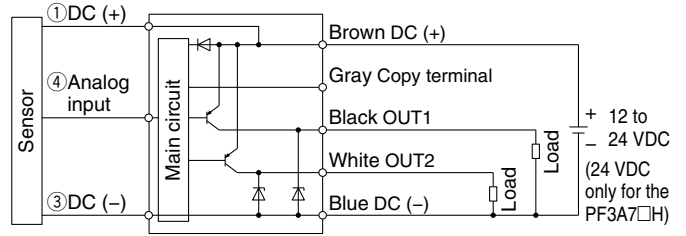

**-RT: NPN (2 outputs) + Analog voltage output
-SV: NPN (2 outputs) + Analog current output**

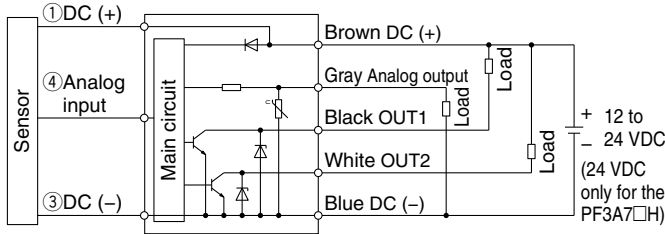

**-RT: PNP (2 outputs) + Analog voltage output
-SV: PNP (2 outputs) + Analog current output**

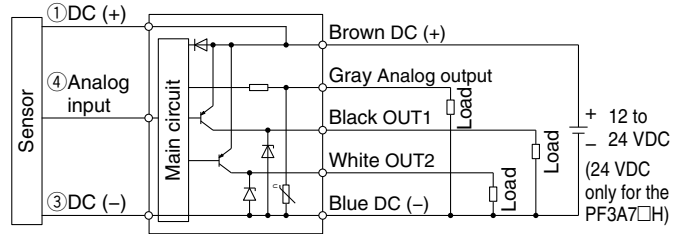

**-RT: NPN (2 outputs) + External input
-SV: NPN (2 outputs) + External input**

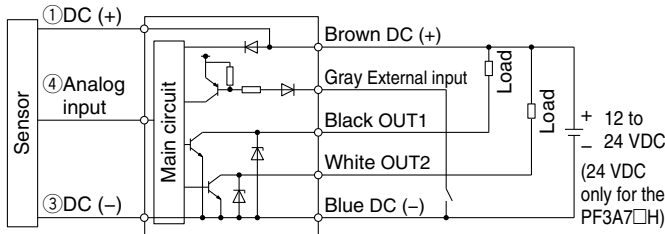

**-RT: PNP (2 outputs) + External input
-SV: PNP (2 outputs) + External input**

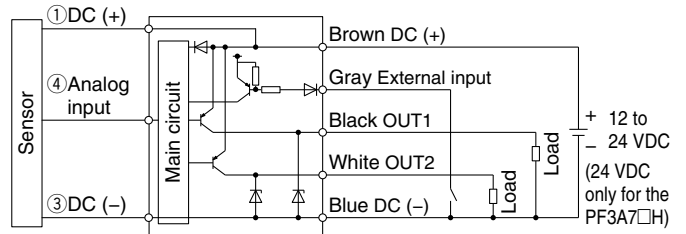

Accumulated pulse output wiring examples

NPN (2 outputs) type

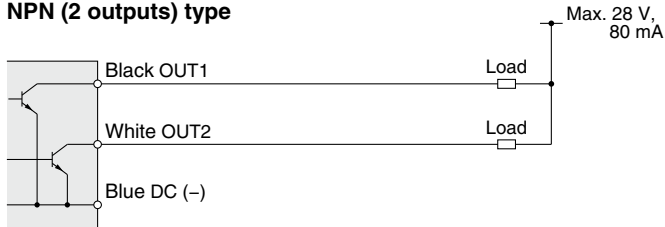

PNP (2 outputs) type

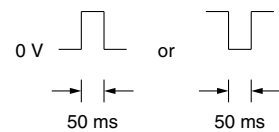
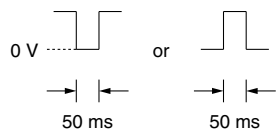
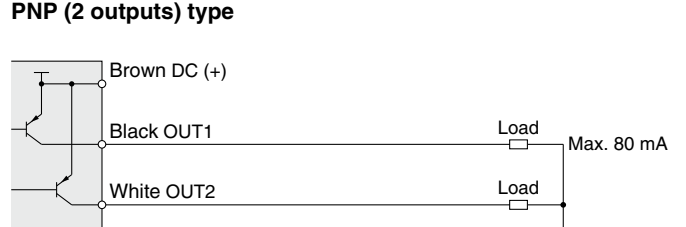

PFG300 Series

Dimensions

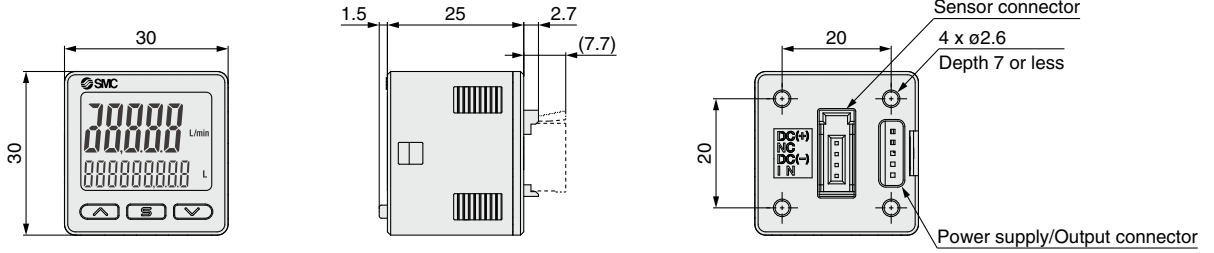

Bracket A (Part no.: ZS-46-A1)

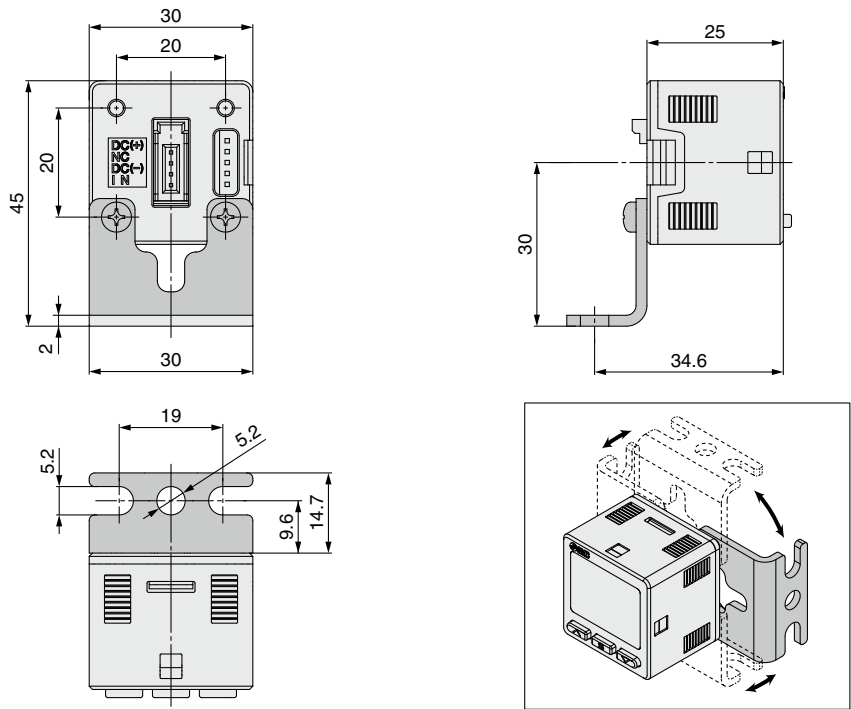

* Bracket configuration allows for mounting in four orientations.

Bracket B (Part no.: ZS-46-A2)

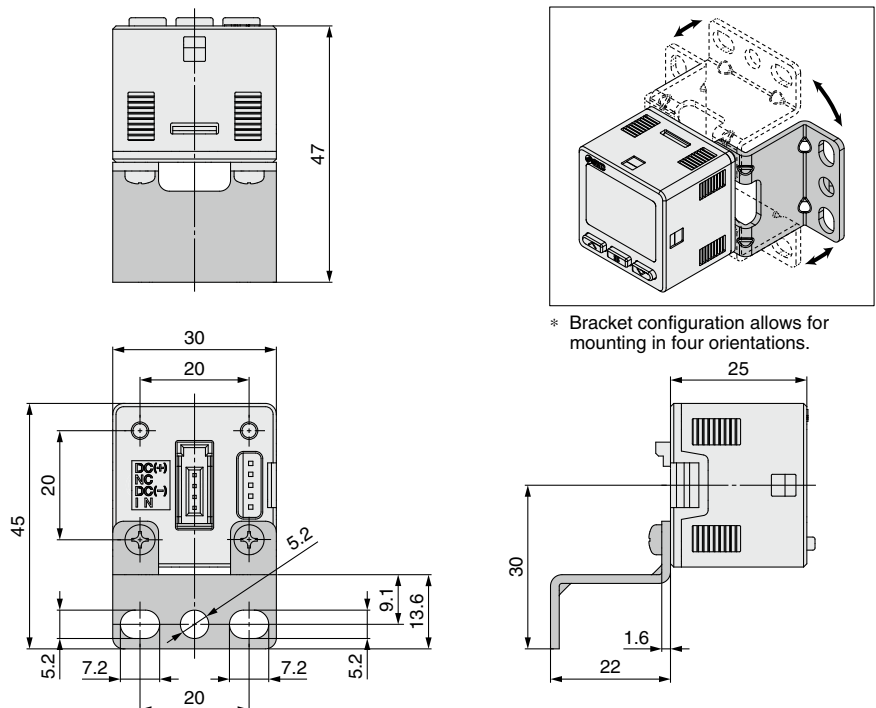

* Bracket configuration allows for mounting in four orientations.

Dimensions

Panel mount adapter (Part no.: ZS-46-B)

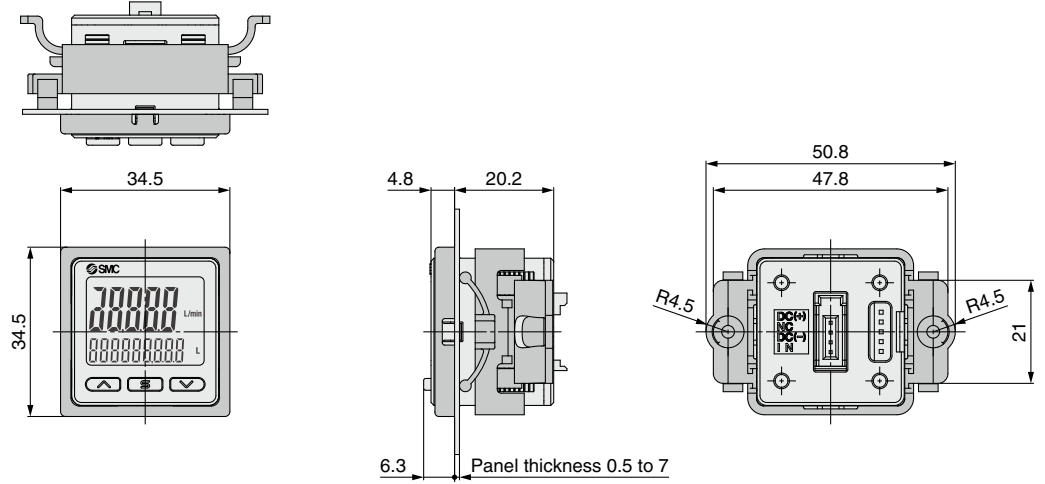

Panel mount adapter + Front protection cover (Part no.: ZS-46-D)

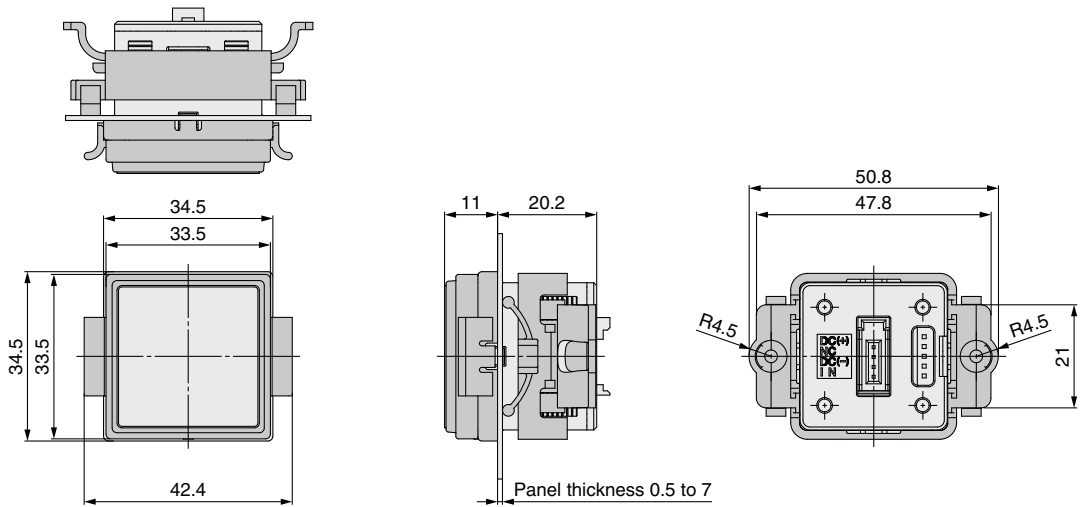

Power supply/output connection lead wire (Part no.: ZS-46-5L)

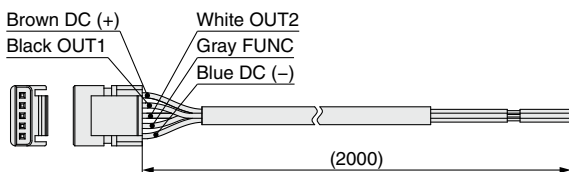

Sensor connector (Part no.: ZS-28-CA-4)

Pin no.	Terminal
1	DC (+)
2	N.C.
3	DC (-)
4	IN*1

*1 1 to 5 V or 4 to 20 mA

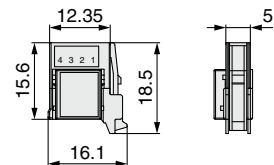

Cable Specifications

Conductor cross section	0.15 mm ² (AWG26)	
Insulator	Outside diameter	1.0 mm
	Color	Brown, Blue, Black, White, Gray (5-core)
Sheath	Finished outside diameter	ø3.5

(Part no.: ZS-28-C-1)

Pin no.	Terminal
1	DC (+)
2	N.C.
3	DC (-)
4	IN*2

*2 1 to 5 V or 4 to 20 mA

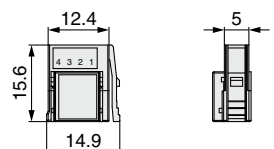

PFG300 Series

Dimensions

Panel fitting dimensions

Individual mounting

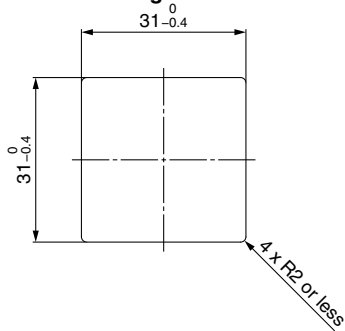

Multiple (2 pcs. or more) secure mounting <Horizontal>

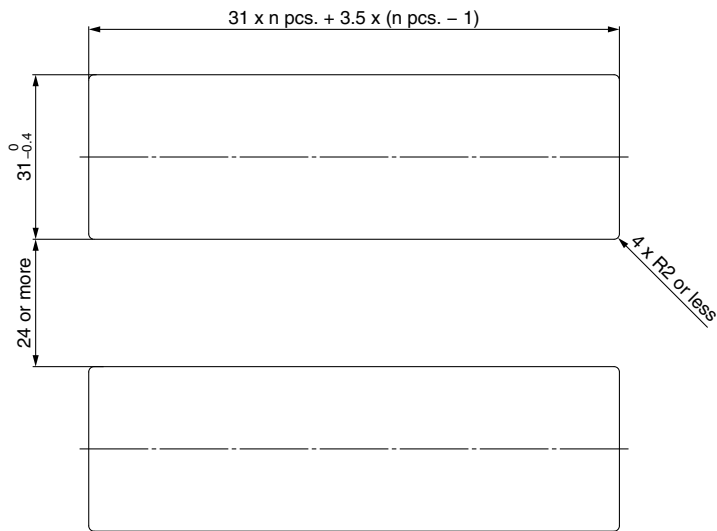

<Vertical>

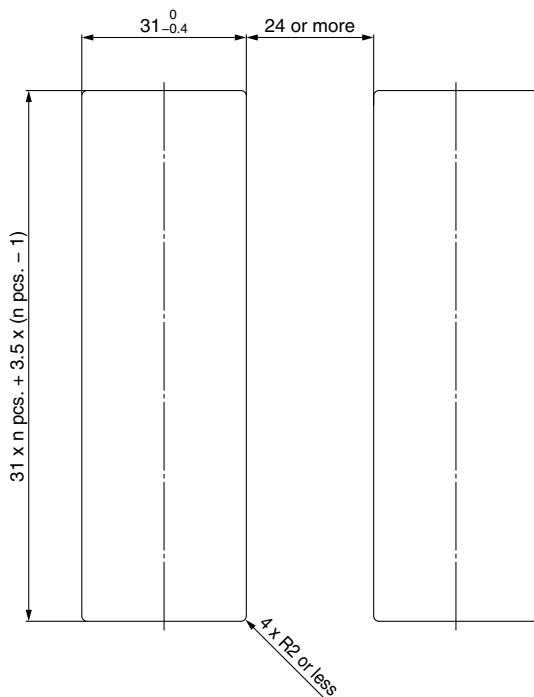

Panel mount example <Horizontal>

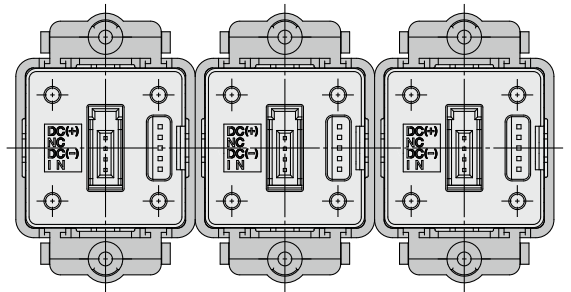

Panel mount example <Vertical>

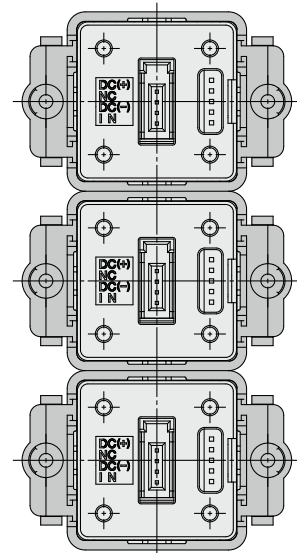



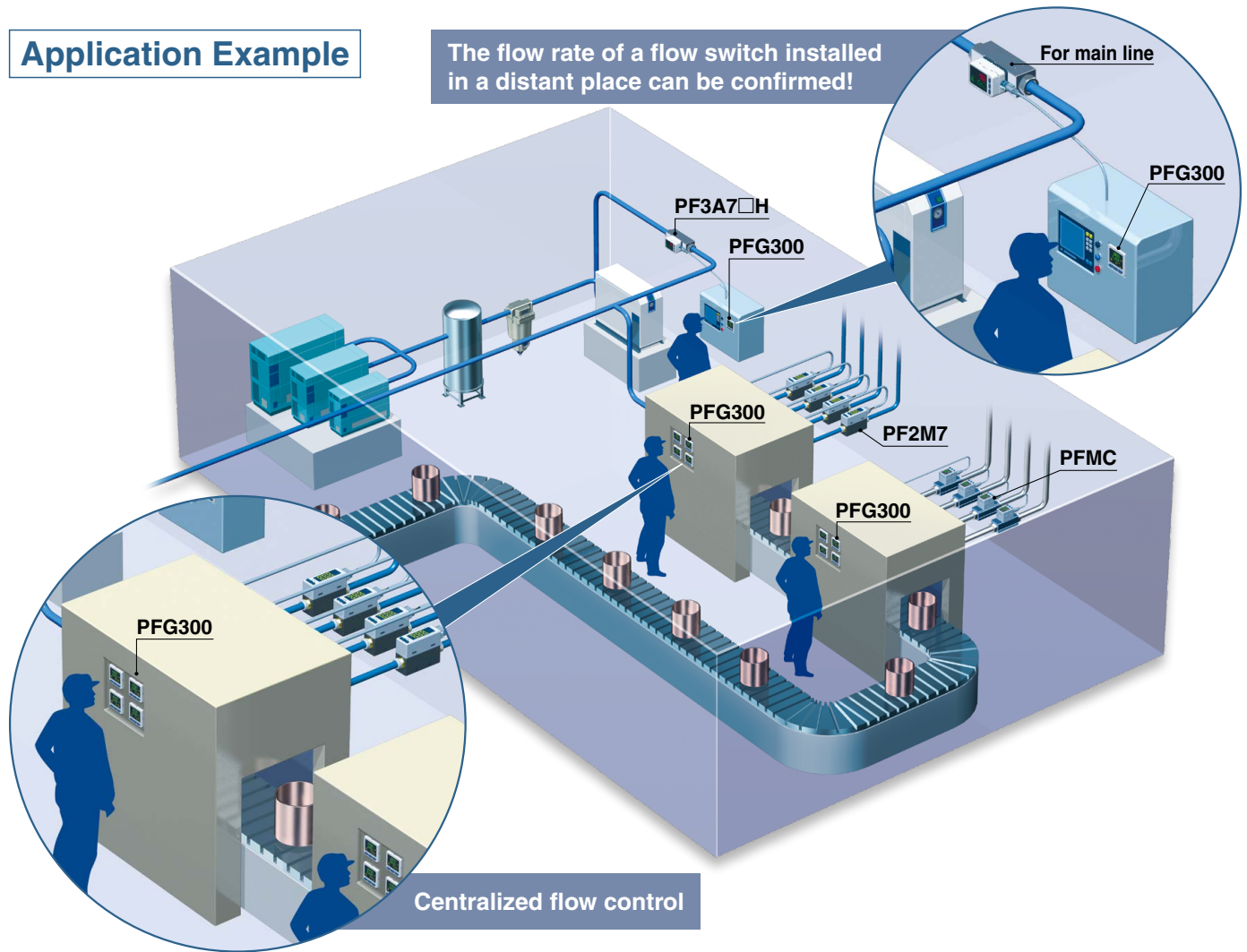

Application Example

The flow rate of a flow switch installed in a distant place can be confirmed!



Applicable Flow Switch Variations

Series	Enclosure	Applicable fluid	Rated flow range	Display
PF2M7  Click here for the catalog (PDF).	IP40	Dry air, N ₂ Ar, CO ₂	0.01 to 1 L/min 0.02 to 2 L/min 0.05 to 5 L/min 0.1 to 10 L/min 0.3 to 25 L/min 0.5 to 50 L/min 1 to 100 L/min 2 to 200 L/min	2-color LCD display
PFMB  Click here for the catalog (PDF).	IP40	Dry air, N ₂	5 to 500 L/min 10 to 1000 L/min 20 to 2000 L/min	2-color LCD display
PF2MC7□(-L)  Click here for the catalog (PDF).	IP65	Dry air, N ₂	5 to 500 L/min 10 to 1000 L/min 20 to 2000 L/min	3-color LCD display
PF3A7□H  Click here for the catalog (PDF).	IP65	Air, N ₂	10 to 1000 L/min 20 to 2000 L/min 30 to 3000 L/min 60 to 6000 L/min 120 to 12000 L/min	3-color LCD display