

Non-contact Gripper *XT661 Series*

- Assists in non-contact workpiece transfer
- Max workpiece suction distance: **10 mm***1

*1 Refer to "Lifting Force—Distance from the Workpiece" on pages 364 to 366.

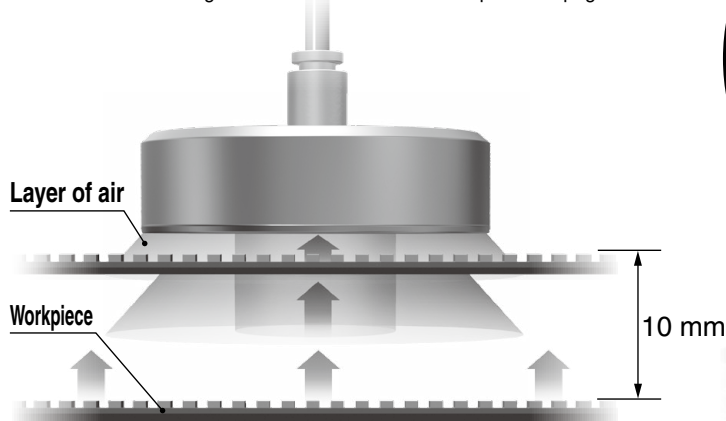

Since there is a layer of air between the workpiece and gripper, non-contact suction is possible.

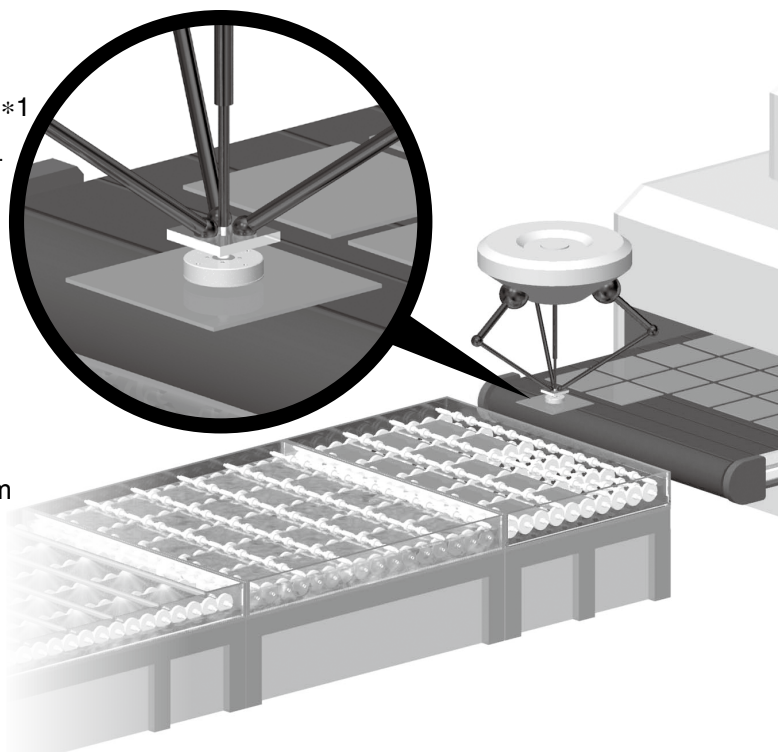

- Two types are available.

■ Cyclone Type

High lift

- High lifting force: Max. 44 N*1

*1 Outer body diameter: $\phi 100$

Lifting force

(Supply pressure: 0.4 MPa)

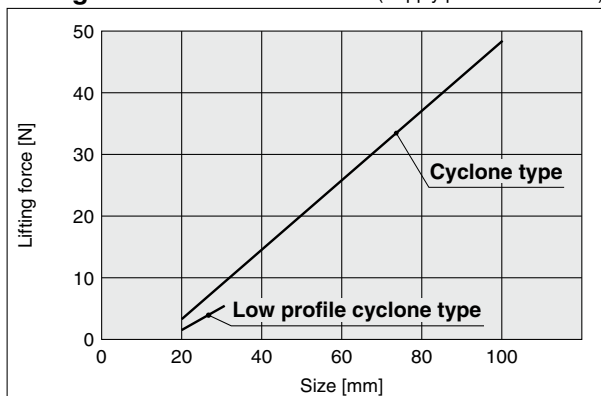

- Totaled 5 size: $\phi 20/\phi 40/\phi 60/\phi 80/\phi 100$

Low profile cyclone type



Totaled 2 size: $\phi 20, \phi 25$

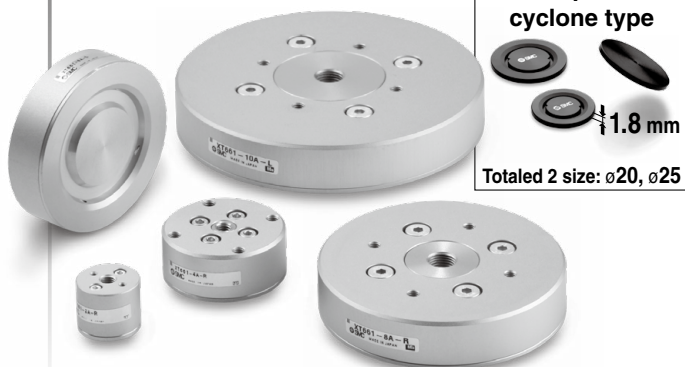

■ Bernoulli Type

Vibration reducing

- Amplitude of the workpiece during gripping: ± 0.01 mm*1, 2 or less

*1 Solar battery silicon cell ($\square 125$ mm, $t = 250$ μ m)

*2 In SMC conditions

(How to calculate: Page 356)

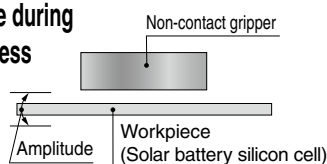

Vibration

(Supply pressure: 0.1 MPa)

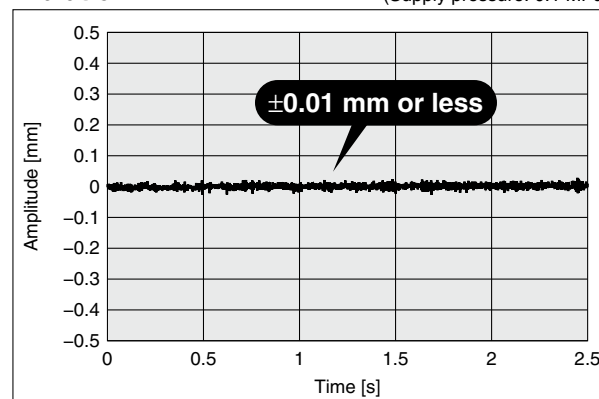

- Totaled 6 size: $\phi 40/\phi 60/\phi 80/\phi 100/\square 120/\square 150$



■ Cyclone Type

High lift

Low air consumption

Body material: Al

Original groove-channel design allows cyclone effect with **large suction area** and **even pressure dispersion!**

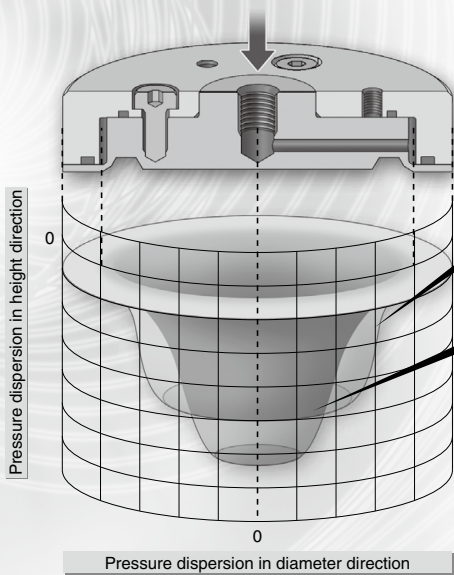

Non-contact gripper

Large vacuum area, even pressure dispersion

Existing SMC cyclone method

Small vacuum area, higher vacuum in the central part



| Outer body diameter [mm] | ø20 | ø40 | ø60 | ø80 | ø100 |
|-------------------------------|-----|-----|-----|-----|------|
| Air consumption [L/min (ANR)] | 77 | 148 | 148 | 148 | 258 |
| Lifting force [N] | 4.3 | 14 | 21 | 26 | 44 |

Supply pressure: 0.4 MPa

Working Principle

Air is discharged in the whirling direction.



● Cyclone Type

Air from the supply port is blown off from the nozzle on the concave suction surface side, creating a whirlwind flow. The whirlwind flow is discharged to the atmosphere from the gap between the non-contact gripper and the workpiece.

As a result, a vacuum zone is created inside the spiral flow due to the cyclone effect, enabling the workpiece to be lifted without physical contact. The action of the centrifugal force of the spiral flow allows a greater lifting force to be generated.

● Various workpiece suction methods are available.

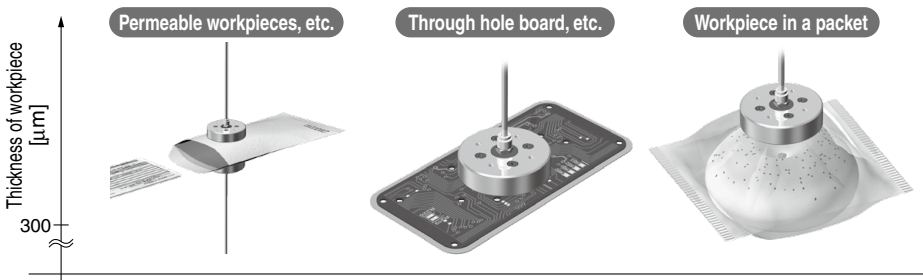

● Grease-free

● Can be disassembled and cleaned the inside

● Made to order

With urethane pad*1 (-X207)

- Mitigation of impacts and prevention of damage during lifting
- No need to install a guide

*1 Except ø20

Refer to page 361.

Urethane pad

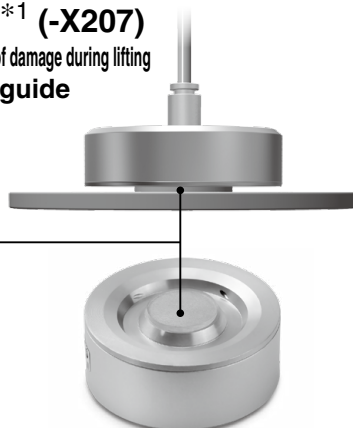

With multi-port (-X211)

The presence of a workpiece can be checked by installing a sensor.

Multi-port

Air supply port

Recommended sensor

Pressure sensor
PSE540 Series



Flow sensor
PFMV Series



For the method of selecting and using a sensor, refer to the operation manual.

Non-contact Gripper *XT661 Series*

Low Profile Cyclone Type (-X260)

Low profile

Made to order

Thickness: **1.8 mm**

Weight: **Approx. 1.3 g**^{*1}

^{*1} Outer body diameter: $\varnothing 20$



| Outer body diameter [mm] | $\varnothing 20$ | $\varnothing 25$ |
|-------------------------------|------------------|------------------|
| Air consumption [L/min (ANR)] | 31 | 31 |
| Lifting force [N] | 1.4 | 2 |

Supply pressure: 0.4 MPa

- Can be mounted on the end of the robot arm
- Two sizes ($\varnothing 20$ and $\varnothing 25$) are available.

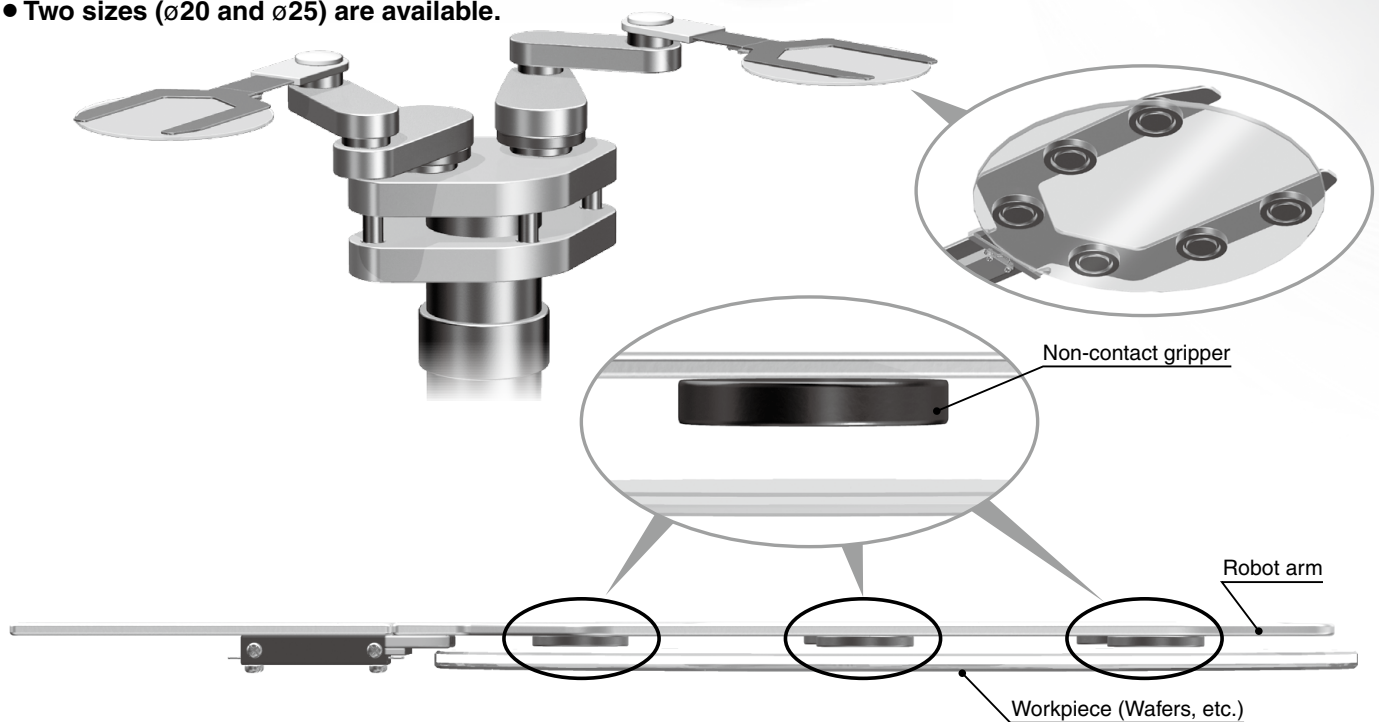

• Mounting

Apply adhesive to the surface on the air supply port side of the non-contact gripper, and mount the gripper on the equipment.

(Be careful that the adhesive does not obstruct the air supply port.)

■ Bernoulli Type

Vibration reducing type

Body material: Resin

Original groove-channel design allows the Bernoulli effect with **suppressing the amplitude of the workpiece during gripping!**

- Reduced amplitude of the workpiece

Size: □120

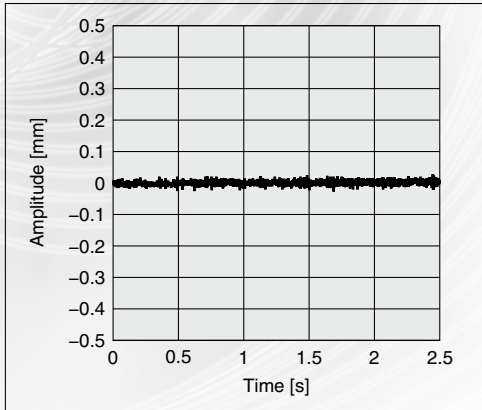

Size: ø100

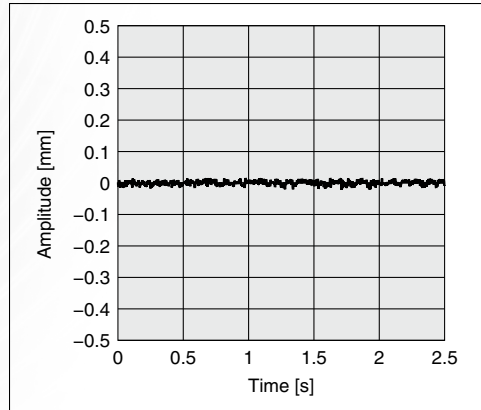

How to calculate

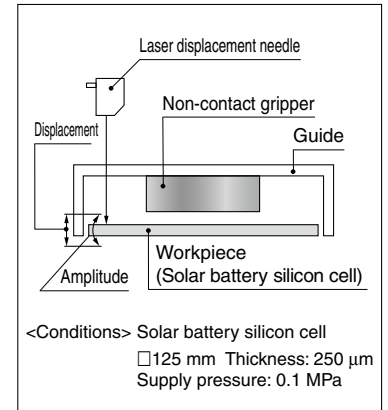

Made to Order

ZP2V

XT661

MHM



| Outer body diameter [mm] | ø40 | ø60 | ø80 | ø100 | □120 | □150 |
|-------------------------------|-----|-----|-----|------|------|------|
| Air consumption [L/min (ANR)] | 98 | 98 | 98 | 156 | 291 | 291 |
| Lifting force [N] | 2.2 | 4.1 | 5.1 | 7.8 | 17 | 14 |

Supply pressure: 0.4 MPa

Working Principle Air is discharged radially.

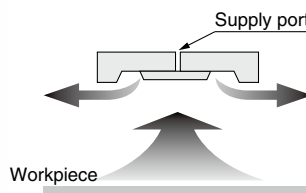
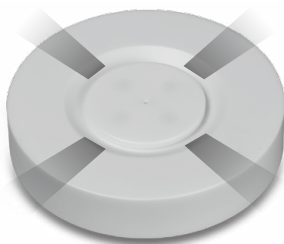

• Bernoulli Type

Air from the supply port is blown off radially from the nozzle on the convex suction surface. The radial flow is discharged to the atmosphere from the gap between the non-contact gripper and the workpiece, and the air between the non-contact gripper and the workpiece is pulled in the peripheral direction. As a result, a vacuum zone is generated in the center, enabling the workpiece to be lifted without physical contact. Also, the original groove-channel design allows the air to be discharged radially, thus suppressing ripples caused by pulsations and whirlwind flow, and enabling the amplitude of the workpiece to be minimized.

- Various workpiece suction methods are available.

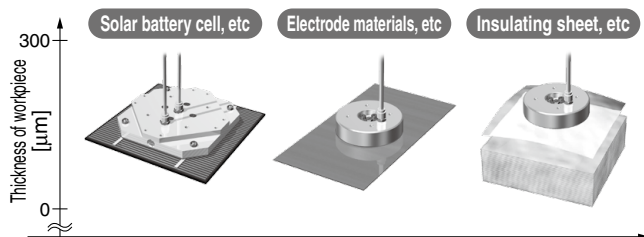

- Reduction of rotation load * No directionality of whirlwind air

- Standardization of multi-port*1 *1 Except ø40

- Grease-free

- Can be disassembled and cleaned the inside

Precautions

Related Products

General
Air

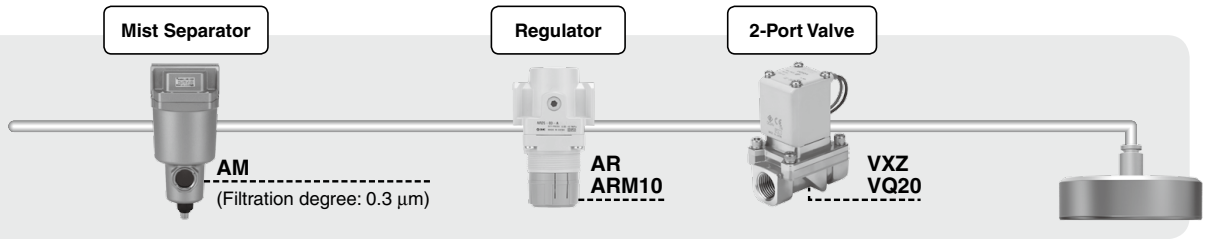

Oil-free
Air

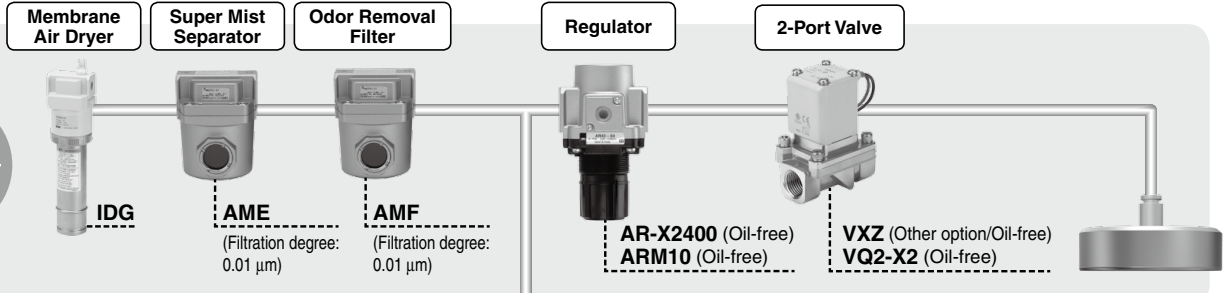

Clean
Air



Clean room production
Parts washed
Double packing/Shipping

For details, refer to the Pneumatic Clean Series (Web Catalog).

<https://www.smcworld.com>

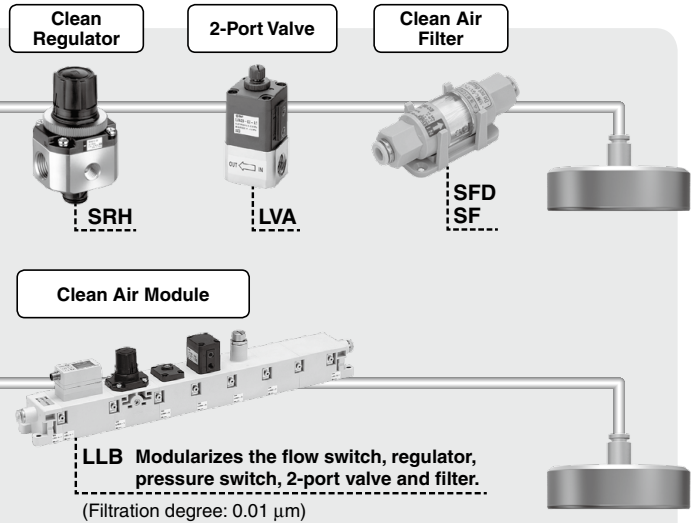

XT661 Series Model Selection

Selection Procedure

1 Check the workpiece and operating conditions.

- 1) Check the kind of workpiece and also its size and weight.
- 2) Check the guide corresponding to the transfer method of the workpiece and "Selection" (Page 360).
At the same time, check the distance between the workpiece to be set and the non-contact gripper.
- 3) Check the supply pressure applied to the non-contact gripper.

2 Check the lifting force.

- 1) Clarify the lifting force corresponding to the distance between the workpiece and the non-contact gripper for each supply pressure.

<How to read the graph>

Example: For the case of "Cyclone type ø60," a supply pressure of **0.2 MPa**, a workpiece mass of **50 g (0.49 N)**, and a **1 mm** distance between the workpiece and the non-contact gripper

<Checking procedure>

From the "Cyclone type ø60" graph, check the lifting force from the intersection of a **1 mm** distance between the workpiece and non-contact gripper and a supply pressure of **0.2 MPa**. Then, extend a horizontal line from this point to the vertical axis to obtain the lifting force.

- 2) Multiply the final lifting force by a safety factor and decide the temporary lifting force. Obtain the temporary lifting force by using the following equation. (Note: The temporary lifting force is the lifting force that has been set after taking into account the safety factor used for selecting a non-contact gripper.)

$$F = f \times (1/t) \quad F: \text{Temporary lifting force [N]} \quad f: \text{Lifting force [N]} \quad t: \text{Safety factor } \dots 2 \text{ or more}$$

- 3) Compare the final lifting force and workpiece mass, and determine the size and number of non-contact grippers such that **the temporary lifting force \geq workpiece mass**.

<Checking procedure>

If **the temporary lifting force \geq workpiece mass**, the gripper can be used under these conditions.

If **the temporary lifting force $<$ workpiece mass**, either increase the size of the non-contact gripper, or increase the number of grippers to be used.

Obtain the required number of grippers from the following equation.

$$N = (9.8 \times W/1000)/(F) \dots \text{Rounding up to the nearest higher integer} \quad N: \text{Q'ty (pcs.)} \quad W: \text{Workpiece mass [g]} \quad F: \text{Temporary lifting force [N]} \quad 9.8: \text{Gravitational acceleration [m/s}^2\text{]}$$

[Cyclone type ø60]

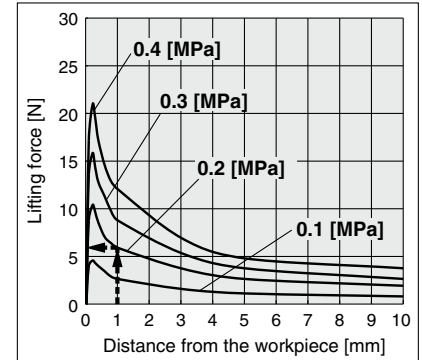

3 Determine the layout of the non-contact grippers.

<Checking procedure>

Determine the positions of the non-contact grippers according to the number of grippers to be used, taking into account the balance of the workpiece.

If the balance of the workpiece is poor during lifting, either increase the size of the non-contact gripper, or increase the number of grippers to be used.

- * The above shows selection procedures for general non-contact grippers; thus, they will not be applicable for all grippers. Customers are required to conduct a test on their own and to select the size of the non-contact grippers and the non-contact grippers to be used based on the test results.

Selection Examples of Non-contact Gripper

Selection example 1 For small workpiece

- Workpiece size: □100 x Plate thickness 3 mm
- Workpiece mass: 300 g
- Distance from the workpiece: 1 mm
- Supply pressure: 0.2 MPa

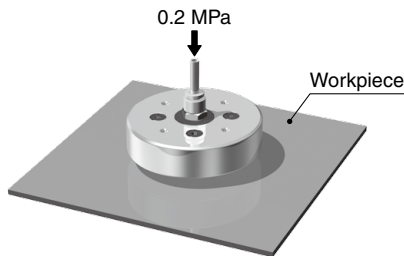

(1) Check the workpiece and operating conditions.

- 1) Workpiece size: □100 x Plate thickness 3 mm
Workpiece mass: 300 g
- 2) Guide: On the top of the workpiece by means of an external stopper
Distance from the workpiece: 1 mm
- 3) Supply pressure: 0.2 MPa

(2) Check the lifting force.

- 1) From the graph (lifting force–distance from the workpiece), check the lifting force at a supply pressure of 0.2 MPa and a 1 mm distance between the workpiece and the non-contact gripper for each size.

**XT661-2A: 0.8 N XT661-4A: 3.8 N XT661-6A: 5.9 N
XT661-8A: 7.5 N XT661-10A: 14.4 N**

- 2) Calculate the temporary lifting force using a safety factor of 2.

**XT661-2A: $F = f \times (1/t) = 0.8 \times (1/2) = 0.4 \text{ N}$
XT661-4A: $F = f \times (1/t) = 3.8 \times (1/2) = 1.9 \text{ N}$
XT661-6A: $F = f \times (1/t) = 5.9 \times (1/2) = 2.95 \text{ N}$
XT661-8A: $F = f \times (1/t) = 7.5 \times (1/2) = 3.75 \text{ N}$
XT661-10A: $F = f \times (1/t) = 14.4 \times (1/2) = 7.2 \text{ N}$**

- 3) Confirm the relationship “temporary lifting force \geq workpiece mass”.

Convert the workpiece mass [g] into a force [N].

$300 \text{ g} \rightarrow 300 \times 9.8/1000 = 2.94 \text{ N}$

For a workpiece mass of 300 g (2.94 N)

**XT661-6A: Temporary lifting force 2.95 N \geq Workpiece mass 300 g (2.94 N)
XT661-8A: Temporary lifting force 3.75 N \geq Workpiece mass 300 g (2.94 N)
XT661-10A: Temporary lifting force 7.2 N \geq Workpiece mass 300 g (2.94 N)**

In this case, the relationship “temporary lifting force \geq workpiece mass” is obtained.

For this workpiece, select the **XT661-6A**.

The number of grippers to be used is **one**.

(3) Determine the layout of the non-contact grippers.

- 1) Install the grippers at the center of gravity (center) of the workpiece, and confirm that there is no problem with the balance of the workpiece during lifting.

Selection example 2 For large workpiece

- Workpiece size: 2200 x 2500 x 0.7 mm
- Workpiece mass: 9.7 kg
- Distance from the workpiece: 0.8 mm
- Supply pressure: 0.3 MPa

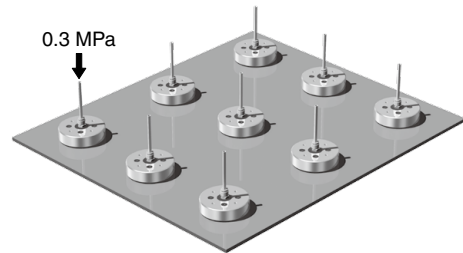

(1) Check the workpiece and operating conditions.

- 1) Workpiece size: 2200 x 2500 x 0.7 mm
Workpiece mass: 9700 g
- 2) Guide: On the end of the workpiece
Distance from the workpiece: 0.8 mm
- 3) Supply pressure: 0.3 MPa

(2) Check the lifting force.

- 1) From the graph (lifting force–distance from the workpiece), check the lifting force at a supply pressure of 0.3 MPa and a 0.8 mm distance between the workpiece and the non-contact gripper for each size.

XT661-10A: 22.4 N

- 2) Calculate the temporary lifting force using a safety factor of 2.

XT661-10A: $F = f \times (1/t) = 22.4 \times (1/2) = 11.2 \text{ N}$

- 3) Confirm the relationship “temporary lifting force \geq workpiece mass”.

Convert the workpiece mass [g] into a force [N].

$9700 \text{ g} \rightarrow 9700 \times 9.8/1000 = 95.06 \text{ N}$

XT661-10A: Temporary lifting force 11.2 N $<$ Workpiece mass 9700 g (95.06 N)

In this case, the relationship “temporary lifting force \geq workpiece mass” is not obtained, so multiple grippers must be used. Obtain the number of grippers to be used from the following equation.

$N = (9.8 \times W/1000)/(F) = (9.8 \times 9700/1000)/(11.2) = 9$

… Rounding up to the nearest higher integer

For this workpiece, select the **XT661-10A**.

The number of grippers to be used is **nine**.

(3) Determine the layout of the non-contact grippers.

- 1) Adequately take into account the center of gravity and deflection of the workpiece, and then install nine non-contact grippers for a well-balanced hold.
(* If a deflection occurs, the lifting force will decrease.)

Selection

Acceleration/Wind pressure/Impact

When transferring the workpiece, take into account not only the workpiece mass, but also acceleration, wind pressure and impact as well. (Refer to Fig. 1.) Particular care must be taken in the case of a flat plate that has a large area. It is necessary to adopt measures such as the installation of a wind pressure prevention cover. Also, even if the relationship **temporary lifting force** \geq **workpiece mass** is adequate, select a larger size that provides a degree of margin. The stability of the lift with respect to acceleration, wind pressure and impact generally increases in proportional to the diameter.

Fig. 1

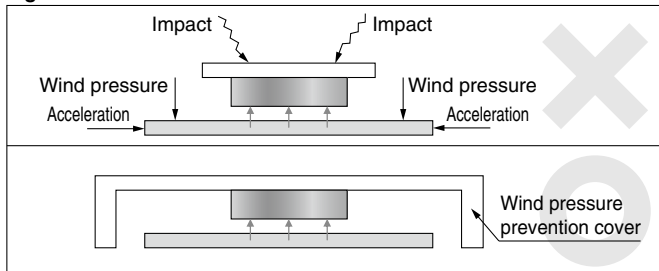

Horizontal force

A non-contact gripper does not produce a restraining force that prevents horizontal movement of the workpiece. It is necessary to install a guide at the end of the workpiece. (Refer to Fig. 2.)

Fig. 2

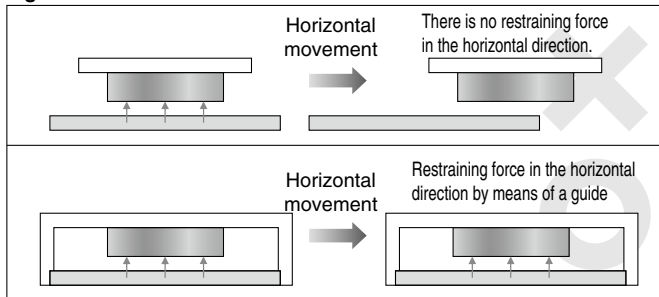

Size of the non-contact gripper and workpiece

Use a non-contact gripper that has an area of less than that of the workpiece. If the area of the gripper is greater than that of the workpiece, a vacuum zone will not occur, so a lifting force will not be generated. (Refer to Fig. 3.)

Fig. 3

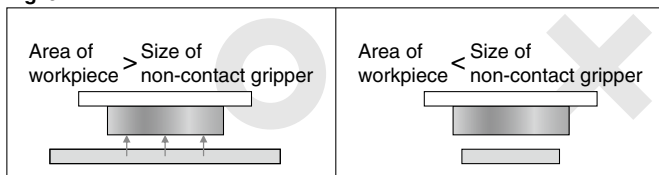

Balance of the workpiece

Install the non-contact gripper at a position such that a moment is not created from the workpiece. (Refer to Fig. 4.) Also, when lifting a flat plate that has a large area with multiple non-contact grippers, install the grippers in such a way that they are well balanced with respect to the workpiece mass. (Refer to Fig. 5.)

Fig. 4

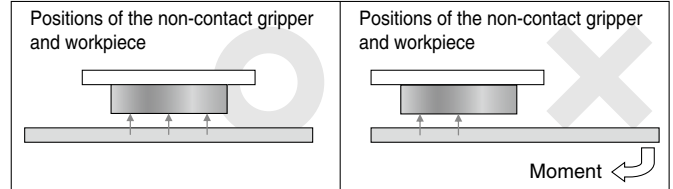
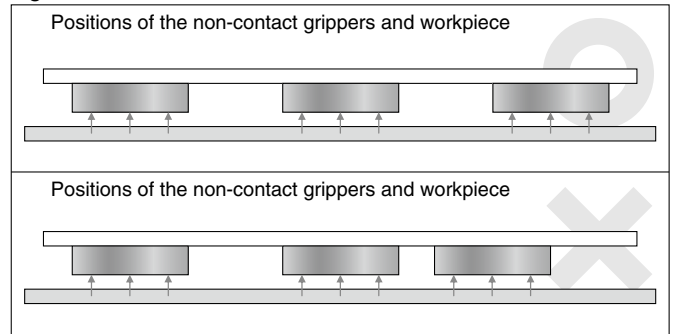

Fig. 5



Mounting orientation

The basic mounting direction of the gripper is horizontal. If the gripper is mounted obliquely or vertically, it must also install a guide and use an adequate safety factor (2 or more).

Precautions for Each Kind of Workpiece

Workpiece with holes

Depending on the size and distribution of the hole, it may be impossible to lift the workpiece. To ensure that the workpiece is lifted, the total area of the holes versus the suction area (aperture ratio) must be 1% or less. However, the lifting force will be reduced, so it is necessary to use an appropriate supply pressure and an adequate safety factor.

Workpiece that has concave/convex surfaces

Depending on the size of the concave/convex surfaces, it may be impossible to lift the workpiece. It is necessary to use an appropriate supply pressure and an adequate safety factor according to the workpiece mass.

Thin workpiece

If the supply pressure is higher than the necessary value, the workpiece may be deformed or damaged due to the lifting force. There is also a possibility of the workpiece vibrating. To prevent this, do not set the supply pressure higher than necessary.

Soft workpiece

As soft workpieces are easy to deform, there is a tendency for the workpiece to touch the bottom of the non-contact gripper. Please be aware that the workpiece may touch the gripper before using.

Other Precautions

Regarding the XT661-2A, there is a limit to the size of the fitting for the supply port that can be used. Use a fitting with an O.D. of $\phi 7$ or less. If a larger size is used, the fitting may interfere with the head of the mounting bolt.

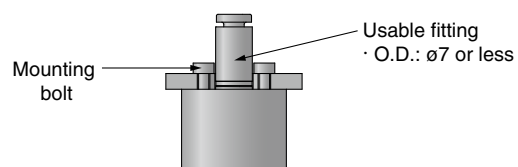

When using a non-contact gripper, install a guide as well.

Provide a guide in accordance with the applications and/or configuration of a workpiece with reference to the following installation examples.

Reasons for installing a guide

■ Holding a workpiece

A non-contact gripper does not produce a restraining force that prevents horizontal movement of the workpiece. Install a guide at the end of the workpiece in order to hold the workpiece.

■ Preventing physical contact

Depending on the operating conditions, the workpiece may touch the gripper. To prevent such contact, install a guide that maintains a certain distance between the gripper and the workpiece.

Installation examples

■ On the end of the workpiece

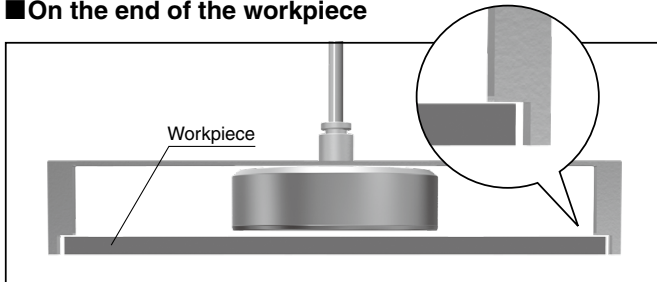

By installing a guide at the end of the workpiece, the contact area can be kept as small as possible.

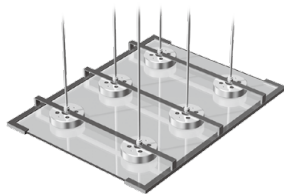

When using multiple non-contact grippers

■ On the top of the workpiece (Use in combination with vacuum pads.)

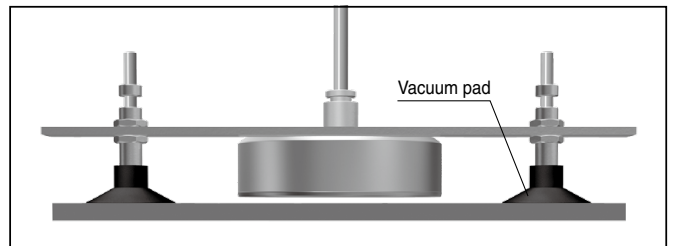

Determine the position of the workpiece using vacuum pads. When transferring the workpiece, use a gripper as well. This ensures contact with the workpiece to be minimized during transferring.

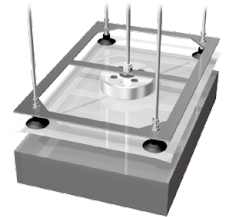

■ On the top of the workpiece (External stopper)

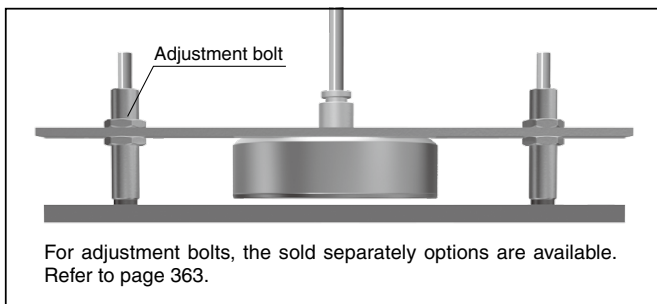

For adjustment bolts, the sold separately options are available. Refer to page 363.

The adjustment bolts make the distance between the non-contact gripper and workpiece adjustable. The guide comes with a bumper to ensure the impact to be minimized and also prevent a damage during lifting the workpiece.

■ With urethane pad

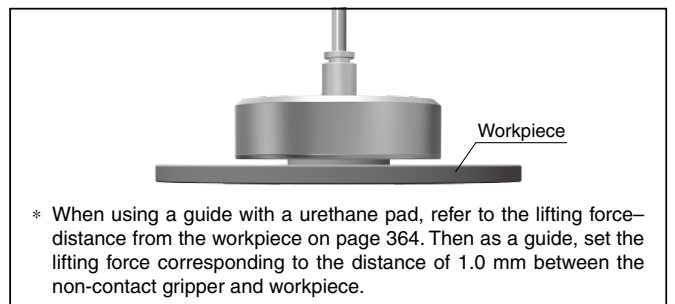

* When using a guide with a urethane pad, refer to the lifting force-distance from the workpiece on page 364. Then as a guide, set the lifting force corresponding to the distance of 1.0 mm between the non-contact gripper and workpiece.

Use the gripper in a contacted condition by means of a urethane pad. This will eliminate the need for a guide.

Non-contact Gripper XT661 Series

Model Selection

How to Order

Cyclone type

XT661 - **2A** - **R**



Outer body diameter: ϕ

| | |
|------------|--------|
| 2A | 20 mm |
| 4A | 40 mm |
| 6A | 60 mm |
| 8A | 80 mm |
| 10A | 100 mm |

Direction of whirling air

| | |
|----------|------------------|
| R | Clockwise |
| L | Counterclockwise |

Low profile cyclone type

XT661 - **2A** - **R** - X260



Outer body diameter: ϕ

| | |
|-----------|-------|
| 2A | 20 mm |
| 3A | 25 mm |

Direction of whirling air

| | |
|----------|------------------|
| R | Clockwise |
| L | Counterclockwise |

Bernoulli type

XT661 - **4C** - X321



Outer body diameter: ϕ

| | |
|------------|-------|
| 4C | 39 mm |
| 6C | 59 mm |
| 8C | 79 mm |
| 10C | 99 mm |

Bernoulli type

XT661 - **120E** - X322

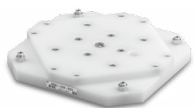

Body size:

| | |
|-------------|--------|
| 120E | 120 mm |
| 150E | 150 mm |

Accessory

| Nil | A | B |
|------|--------------------|------------------------------|
| None | Guide assembly | Adjustment bolt assembly |

Specifications

| | 2A | 4A | 6A | 8A | 10A |
|------------------------------------|--------------------------|-----------|-----------|-----------|------------|
| Outer body diameter [mm] | ϕ 20 | ϕ 40 | ϕ 60 | ϕ 80 | ϕ 100 |
| Piping port size | M5 x 0.8 | | | Rc 1/8 | |
| Fluid | Air ^{*1} | | | | |
| Operating pressure | 0.01 to 0.5 MPa | | | | |
| Proof pressure | 0.75 MPa | | | | |
| Ambient and operating temperatures | -5 to 60°C (no freezing) | | | | |
| Grease | Grease-free | | | | |
| Body material | A2017 | | | | |
| Weight [g] | 12.5 | 49 | 114 | 206 | 310 |

*1 Air purification rating: JIS B 8392-1 (ISO 8573-1) Quality Degree 4, 4, 2 or more

| | 2A | 3A |
|------------------------------------|--------------------------|-----------|
| Outer body diameter [mm] | ϕ 20 | ϕ 25 |
| Piping port size | ϕ 1.6 | |
| Fluid | Air ^{*1} | |
| Operating pressure | 0.01 to 0.5 MPa | |
| Proof pressure | 0.75 MPa | |
| Ambient and operating temperatures | -5 to 40°C (no freezing) | |
| Grease | Grease-free | |
| Body material | A2017 | |
| Weight [g] | 1.33 | 2.13 |

*1 Air purification rating: JIS B 8392-1 (ISO 8573-1) Quality Degree 4, 4, 2 or more

* Use adhesive to mount the gripper.

| | 4C | 6C | 8C | 10C | 120E | 150E |
|------------------------------------|--------------------------|-----------|-----------|-----------|---------------|---------------|
| Outer body diameter [mm] | ϕ 39 | ϕ 59 | ϕ 79 | ϕ 99 | \square 120 | \square 150 |
| Piping port size | M5 x 0.8 | | | Rc 1/8 | | |
| Fluid | Air ^{*1} | | | | | |
| Operating pressure | 0.01 to 0.4 MPa | | | | | |
| Proof pressure | 0.6 MPa | | | | | |
| Ambient and operating temperatures | -5 to 40°C (no freezing) | | | | | |
| Grease | Grease-free | | | | | |
| Body material | PBT | | | | | |
| Weight [g] | 26 | 55 | 108 | 170 | 260 | 410 |

*1 Air purification rating: JIS B 8392-1 (ISO 8573-1) Quality Degree 4, 4, 2 or more

Made to Order

ZP2V

XT661

MHM

Precautions

Sold Separately Options: External Stopper (Order Separately)

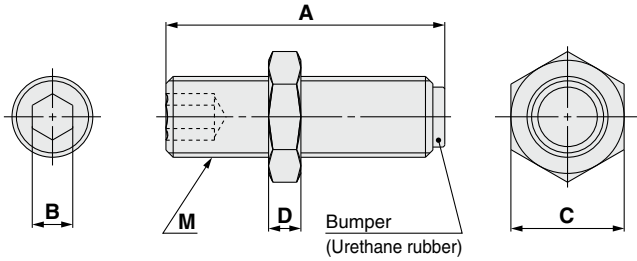

| Model | Adjustment range [mm] | A | B | C | D | M |
|---------------|-----------------------|------|-----|----|-----|------------|
| MXQ-A627 | 5 | 16.5 | 2.5 | 7 | 3 | M5 x 0.8 |
| MXQ-A627-X11 | 15 | 26.5 | | | | |
| MXQ-A827 | 5 | 16.5 | 3 | 8 | 3.5 | M6 x 1 |
| MXQ-A827-X11 | 15 | 26.5 | | | | |
| MXQ-A827-X12 | 25 | 36.5 | | | | |
| MXQ-A1227 | 5 | 20 | 4 | 12 | 4 | M8 x 1 |
| MXQ-A1227-X11 | 15 | 30 | | | | |
| MXQ-A1227-X12 | 25 | 40 | | | | |
| MXQ-A1627 | 5 | 24.5 | 5 | 14 | 4 | M10 x 1 |
| MXQ-A1627-X11 | 15 | 34.5 | | | | |
| MXQ-A1627-X12 | 25 | 44.5 | | | | |
| MXQ-A2027 | 5 | 27.5 | 6 | 17 | 5 | M12 x 1.25 |
| MXQ-A2027-X11 | 15 | 37.5 | | | | |
| MXQ-A2027-X12 | 25 | 47.5 | | | | |
| MXQ-A2527 | 5 | 32.5 | 6 | 19 | 6 | M14 x 1.5 |
| MXQ-A2527-X11 | 15 | 42.5 | | | | |
| MXQ-A2527-X12 | 25 | 52.5 | | | | |

Lifting Force [Cyclone Type]

Size: $\phi 20$

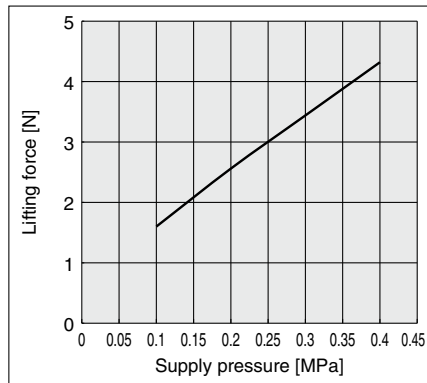

Size: $\phi 40/\phi 60/\phi 80$

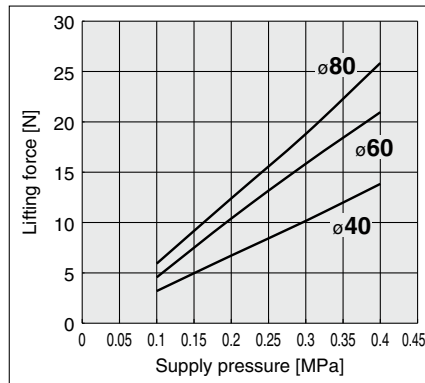

Size: $\phi 100$

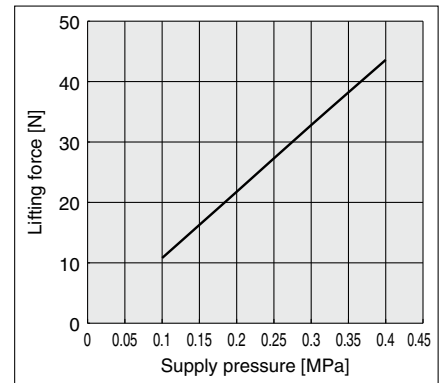

Lifting Force [Low Profile Cyclone Type]

Size: $\phi 20$

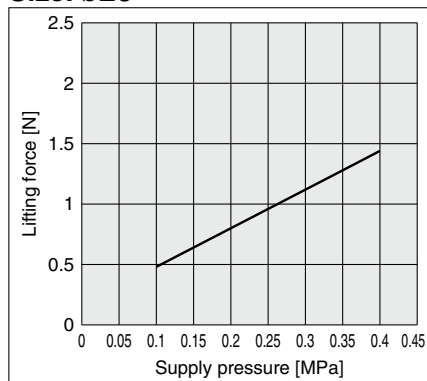

Size: $\phi 25$

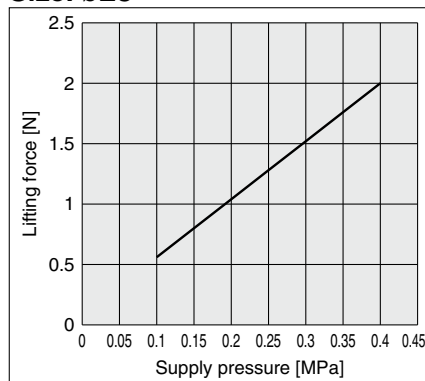

Air Consumption [Cyclone Type]

Size: $\phi 20$

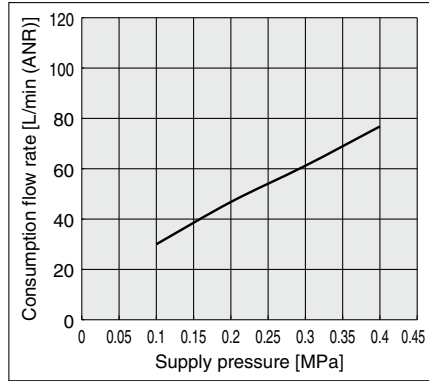

Size: $\phi 40/\phi 60/\phi 80$

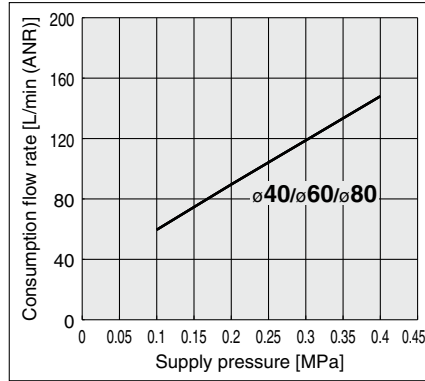

Size: $\phi 100$

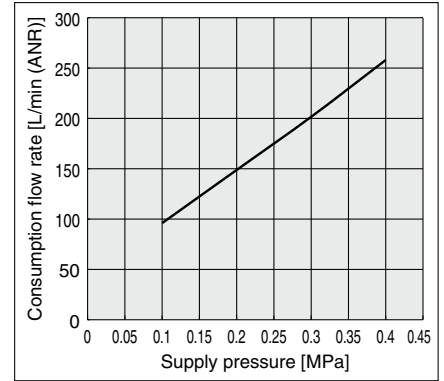

Air Consumption [Low Profile Cyclone Type]

Size: $\phi 20/\phi 25$

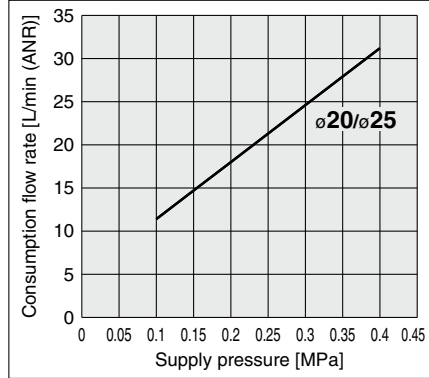

Lifting Force–Distance from the Workpiece [Cyclone Type]

Size: $\phi 20$

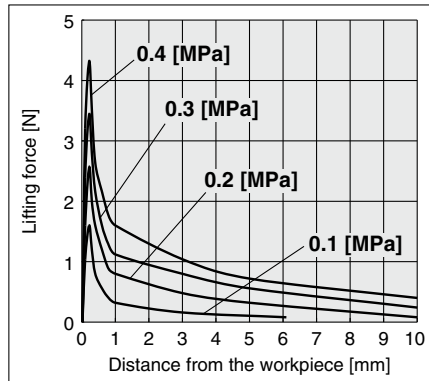

Size: $\phi 40$

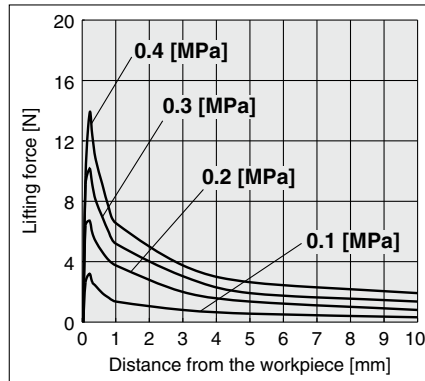

Size: $\phi 60$

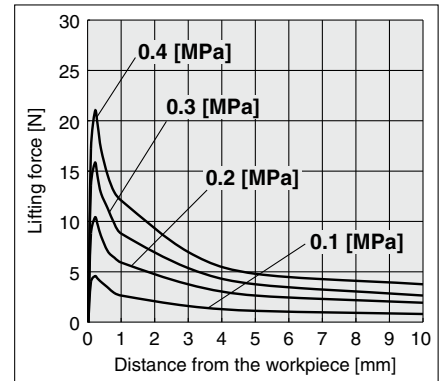

Size: $\phi 80$

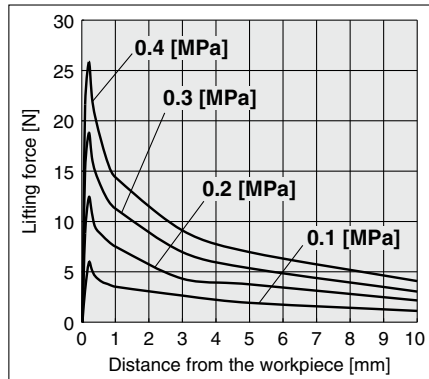

Size: $\phi 100$

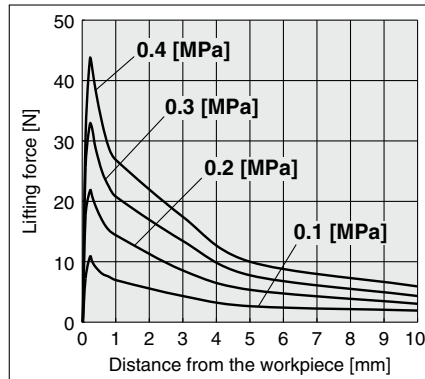

Lifting Force–Distance from the Workpiece [Low Profile Cyclone Type]

Size: $\phi 20$

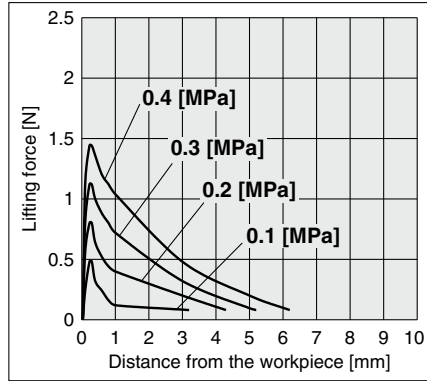

Size: $\phi 25$

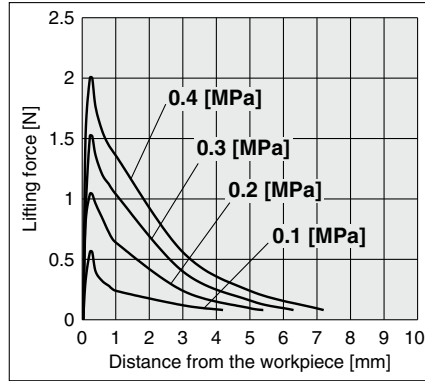

Lifting Force [Bernoulli Type]

Size: $\phi 40/\phi 60/\phi 80$

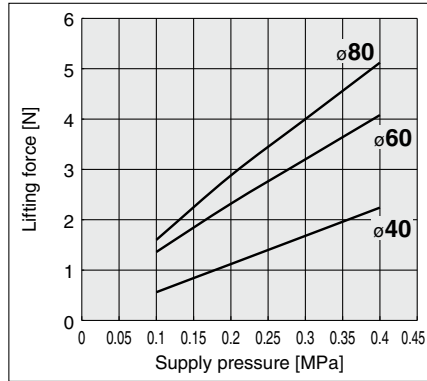

Size: $\phi 100$

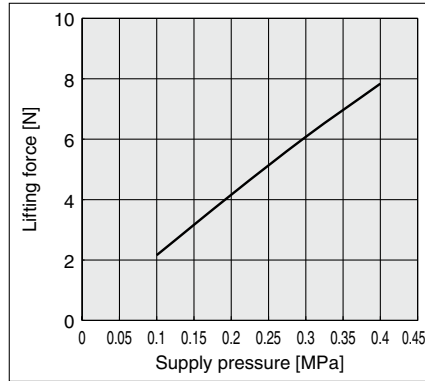

Size: $\square 120/\square 150$

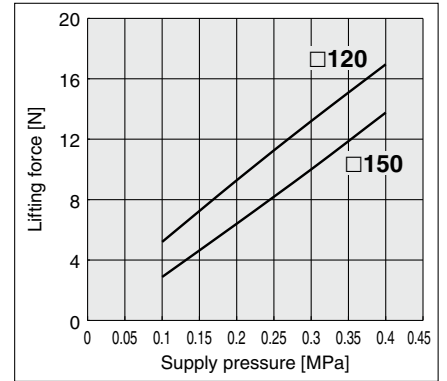

Air Consumption [Bernoulli Type]

Size: $\phi 40/\phi 60/\phi 80$

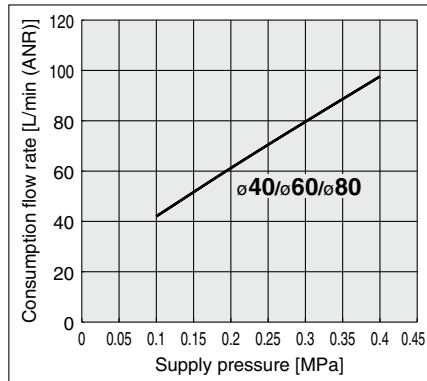

Size: $\phi 100$

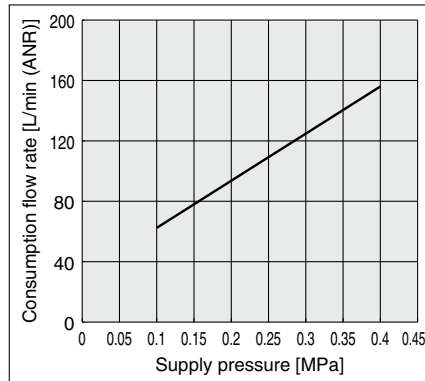

Size: $\square 120/\square 150$

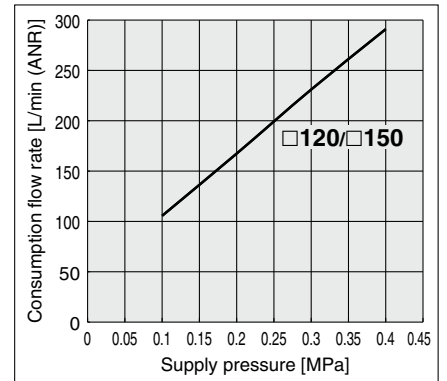

Lifting Force–Distance from the Workpiece [Bernoulli Type]

Size: $\varnothing 40$

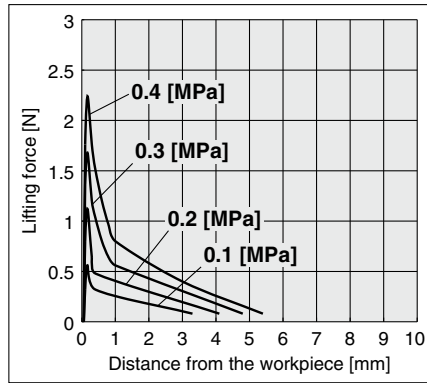

Size: $\varnothing 60$

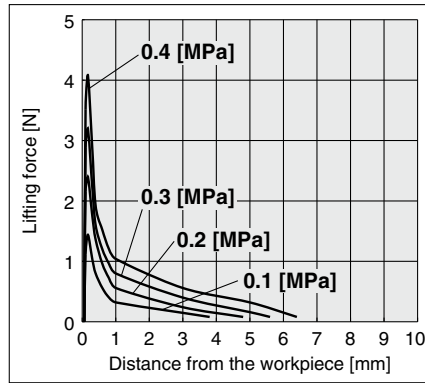

Size: $\varnothing 80$

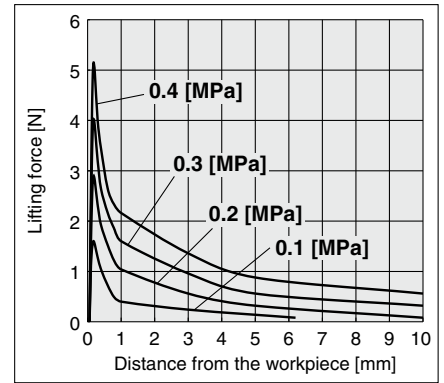

Size: $\varnothing 100$

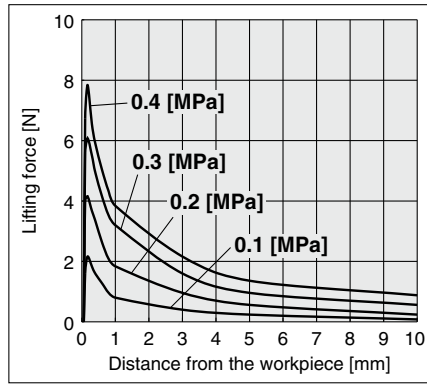

Size: $\square 120$

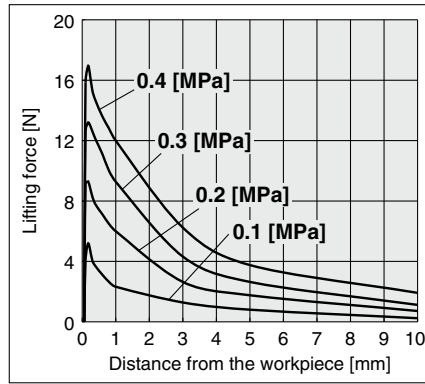

Size: $\square 150$

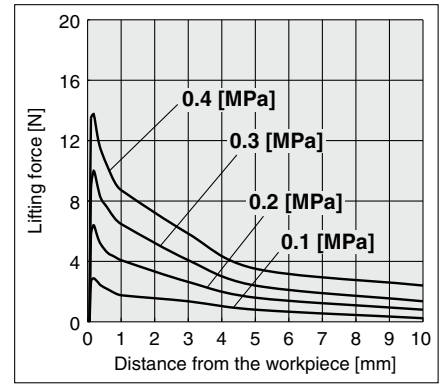

Vibration [Bernoulli Type] Supply pressure: 0.1 MPa

Size: $\varnothing 40$

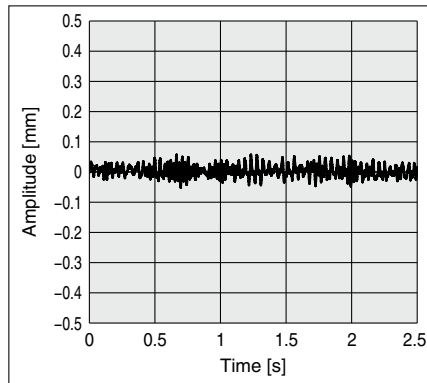

Size: $\varnothing 60$

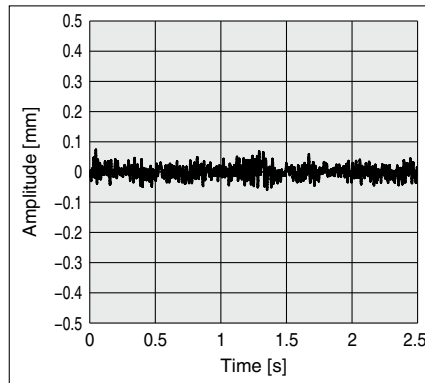

Size: $\varnothing 80$

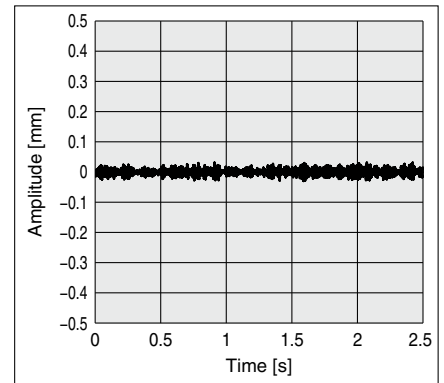

Size: $\varnothing 100$

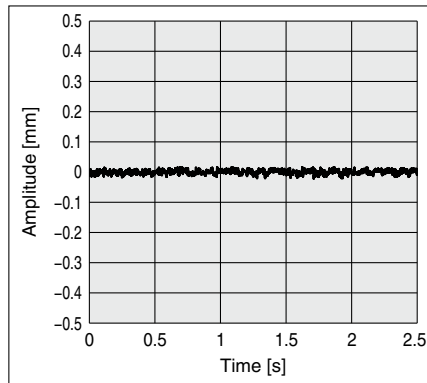

Size: $\square 120$

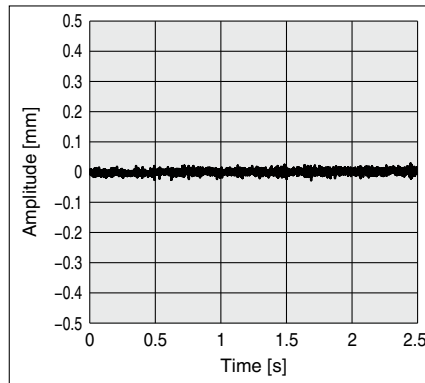

Size: $\square 150$

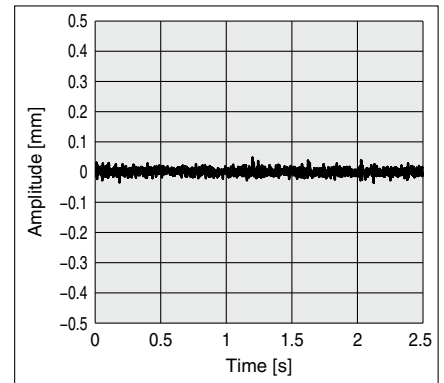

* $\square 150$ solar cell is used for this data only.

Non-contact Gripper *XT661 Series*

Construction [Cyclone Type]

Size: $\varnothing 20$

Size: $\varnothing 40, \varnothing 60, \varnothing 80, \varnothing 100$

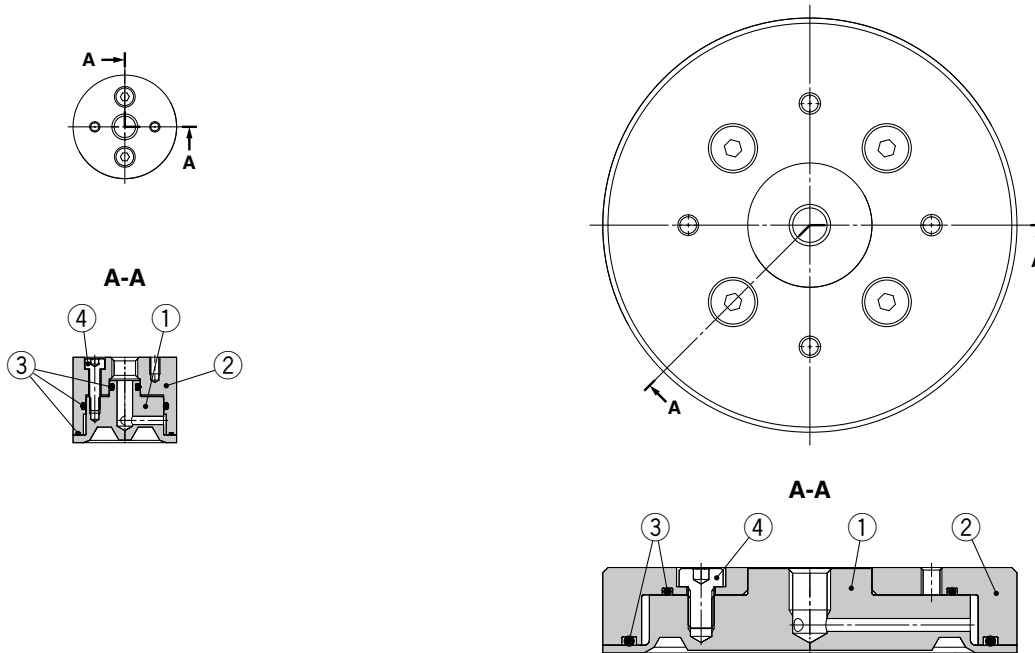

Component Parts

| No. | Description | Material | Note |
|-----|-------------------------------|--------------------------------|-----------------|
| 1 | Body (R, L) | Aluminum alloy (Hard anodized) | XT661-2A to 10A |
| 2 | Body M | Aluminum alloy (Hard anodized) | |
| 3 | O-ring | NBR | |
| 4 | Hexagon socket head cap screw | Stainless steel | |

Construction [Low Profile Cyclone Type]

Size: $\varnothing 20, \varnothing 25$

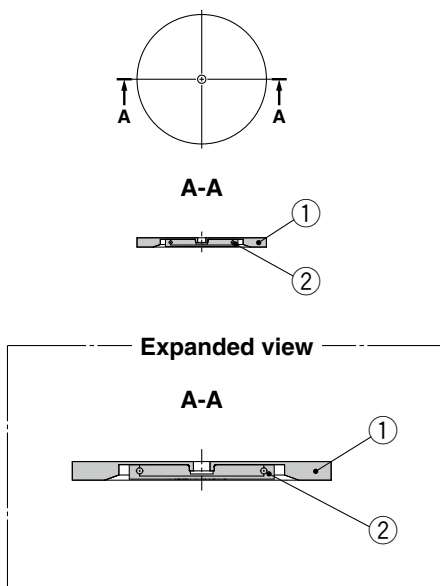

Component Parts

| No. | Description | Material | Note |
|-----|-------------|--------------------------------------|--------------|
| 1 | Body (R, L) | Aluminum alloy (Black hard anodized) | XT661-2A, 3A |
| 2 | Body M | Aluminum alloy (Black hard anodized) | |

Construction [Bernoulli Type]

Size: $\varnothing 40$

Size: $\varnothing 60$

Size: $\varnothing 80, \varnothing 100$

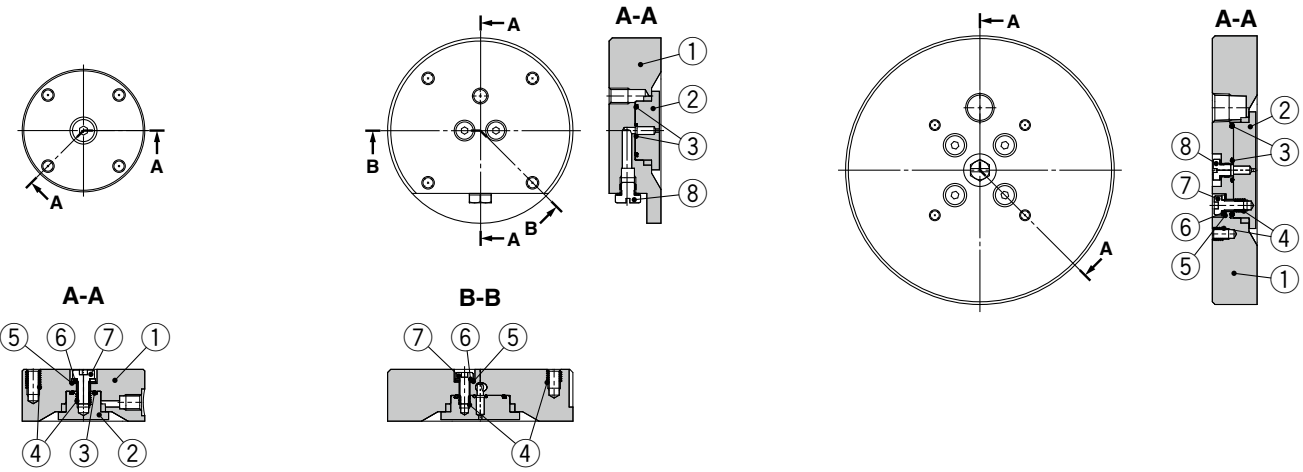

Size: $\square 120, \square 150$

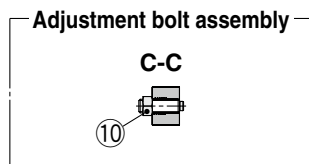
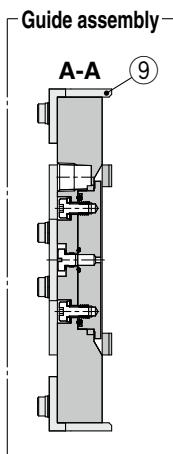
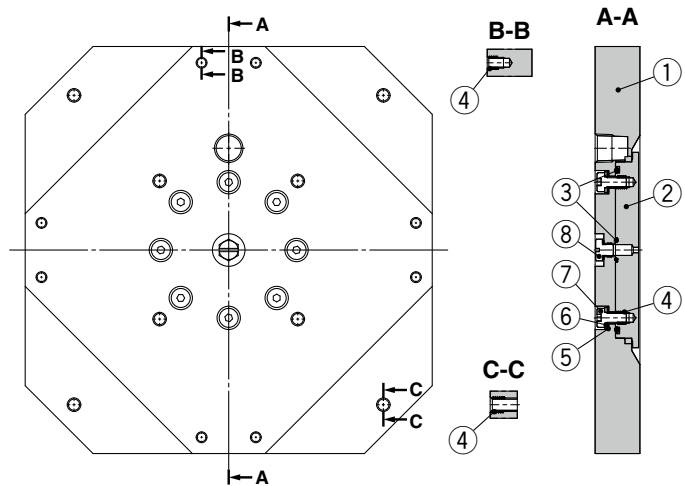

Component Parts

| No. | Description | Material | Note |
|-----|-------------------------------|---|-------------------------------------|
| 1 | Body A | PBT resin | |
| 2 | Body B | PBT resin | |
| 3 | O-ring | NBR | |
| 4 | Helical insert | Stainless steel | |
| 5 | Flat washer | Chromium molybdenum steel (Zinc chromated) | XT661-4C to 10C XT661-120E, 150E |
| 6 | Spring washer | Chromium molybdenum steel (Zinc chromated) | |
| 7 | Hexagon socket head cap screw | Chromium molybdenum steel (Zinc chromated) | |
| 8 | Plug | Brass/NBR/Stainless steel | Except XT661-4C |
| 9 | Guide assembly | POM/Chromium molybdenum steel (Zinc chromated) | Accessories for XT661-120E, 150E |
| 10 | Adjustment bolt assembly | Polyurethane/Chromium molybdenum steel, mild steel (Zinc chromated) | |

Made to Order

ZP2V

XT661

MHM

Precautions

Non-contact Gripper **XT661 Series**

Dimensions [Cyclone Type]

XT661-2A-(R, L)

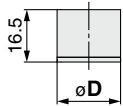
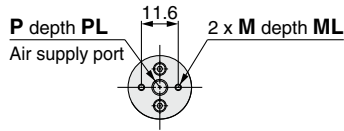

XT661-4A-(R, L)

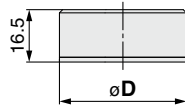
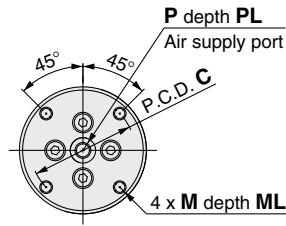

XT661-6A-(R, L)

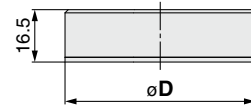
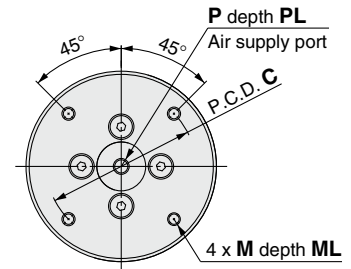

XT661-8A-(R, L)

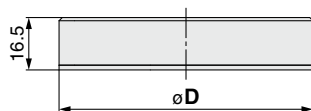
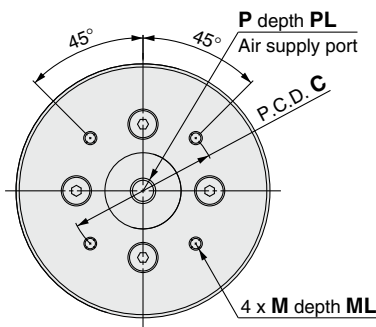

XT661-10A-(R, L)

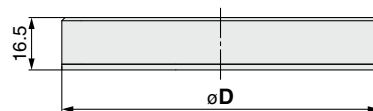
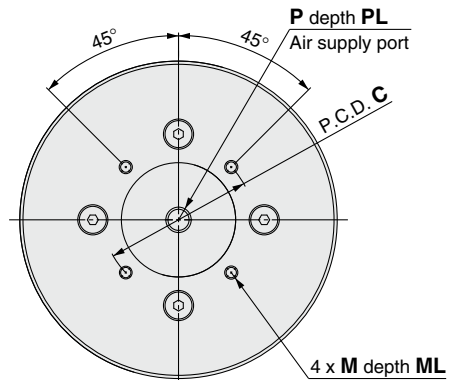

[mm]

| Part no. | P | PL | M | ML | C | D |
|------------------|----------|----|----------|-----|------|-----|
| XT661-2A-(R, L) | M5 x 0.8 | 5 | M2 x 0.4 | 3.2 | — | 20 |
| XT661-4A-(R, L) | M5 x 0.8 | 5 | M4 x 0.7 | 5 | 32.8 | 40 |
| XT661-6A-(R, L) | M5 x 0.8 | 5 | M4 x 0.7 | 5 | 47 | 60 |
| XT661-8A-(R, L) | Rc 1/8 | — | M4 x 0.7 | 5 | 47 | 80 |
| XT661-10A-(R, L) | Rc 1/8 | — | M4 x 0.7 | 5 | 47 | 100 |

Dimensions [Low Profile Cyclone Type]

XT661-2A-(R, L)-X260

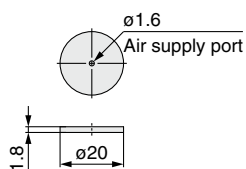

XT661-3A-(R, L)-X260

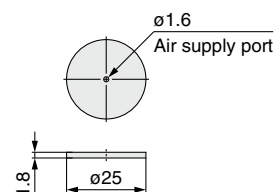

Dimensions [Bernoulli Type]

XT661-4C-X321

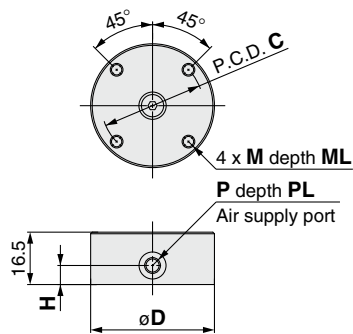

XT661-6C-X321

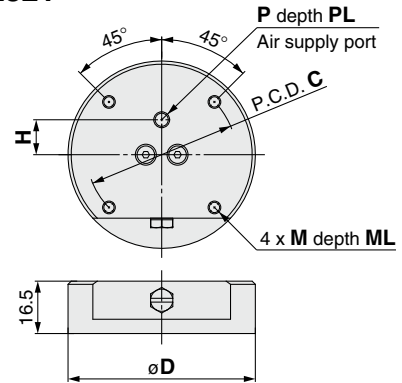

XT661-8C-X321

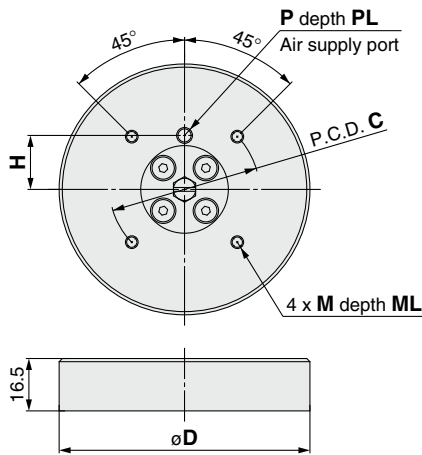

XT661-10C-X321

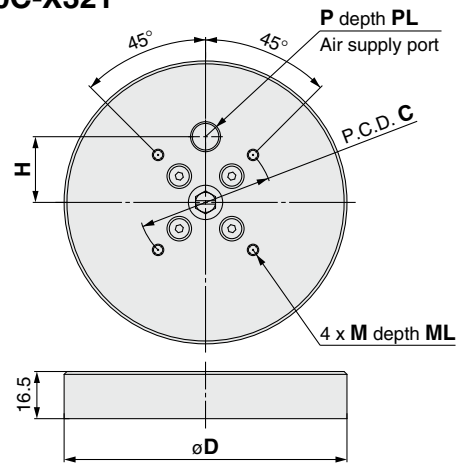

XT661-120E-X322

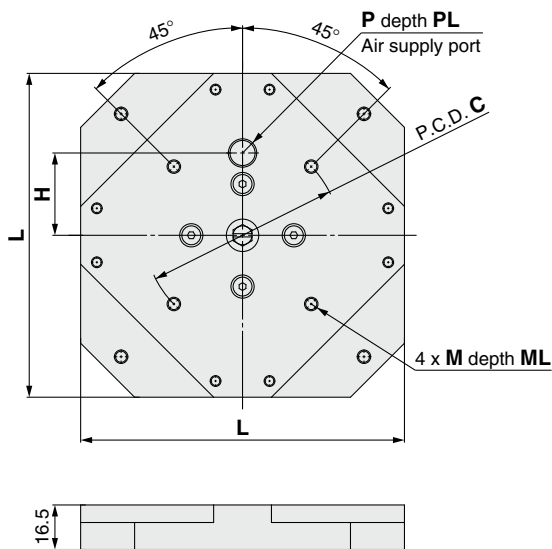

XT661-150E-X322

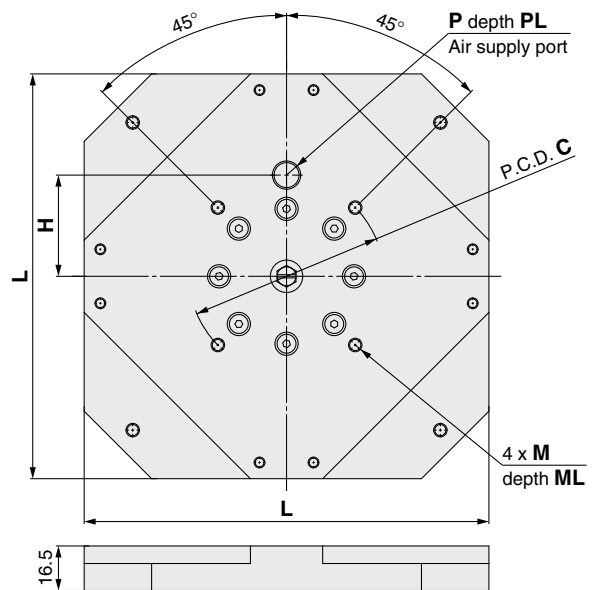

| Part no. | P | PL | M | ML | C | H | D | L |
|------------------------|----------|----|----------|----|----|------|----|-----|
| XT661-4C-X321 | M5 x 0.8 | 5 | M4 x 0.7 | 8 | 32 | 6 | 39 | — |
| XT661-6C-X321 | M5 x 0.8 | 6 | M4 x 0.7 | 6 | 47 | 11 | 59 | — |
| XT661-8C-X321 | M5 x 0.8 | 6 | M4 x 0.7 | 6 | 47 | 17 | 79 | — |
| XT661-10C-X321 | Rc 1/8 | — | M4 x 0.7 | 6 | 47 | 23 | 99 | — |
| XT661-120E-X322 | Rc 1/8 | — | M5 x 0.8 | 7 | 72 | 30.5 | — | 120 |
| XT661-150E-X322 | Rc 1/8 | — | M5 x 0.8 | 7 | 72 | 37.5 | — | 150 |

Non-contact Gripper *XT661 Series*

Dimensions [Bernoulli Type]

With guide assembly

Size: □120

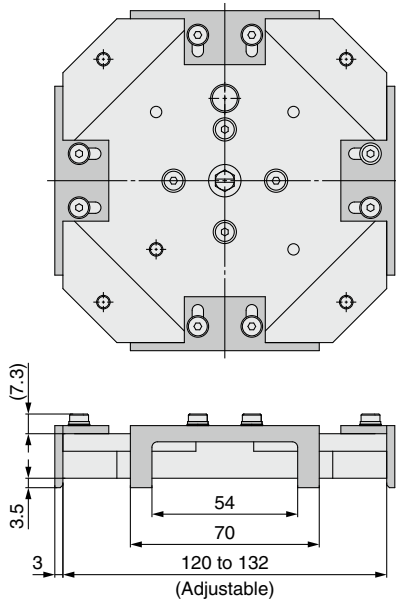

Size: □150

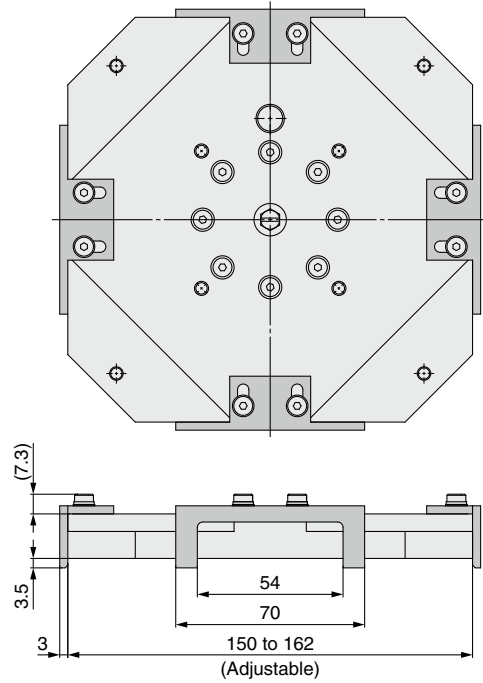

With adjustment bolt assembly

Size: □120

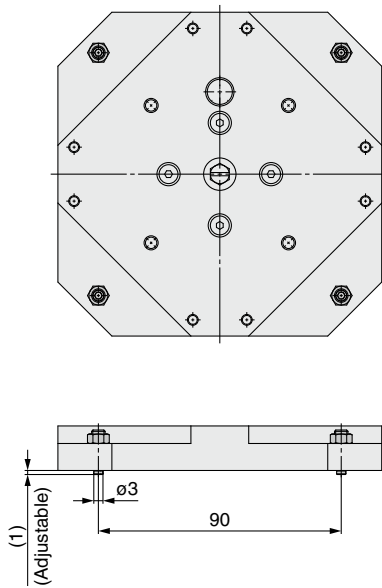

Size: □150

