

Stroke Reading Cylinder with Brake

CE2 Series

ø40, ø50, ø63, ø80, ø100



**Brake mechanism added
to a stroke reading cylinder
which can measure
stroke length.**

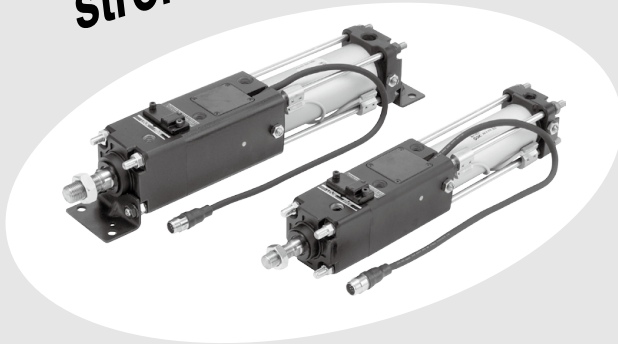

Multi Counter/CEU5



Stroke Reading Cylinder with Brake/CE2

Multi-counter/CEU5

A stroke reading cylinder with an added brake mechanism which can measure stroke length

Brake mechanism

Employs a combination spring and pneumatic lock type.

When there is a drop in air pressure, the workpiece is held by a spring lock.

Locking in both directions is possible.

Locking in either side of cylinder stroke is possible, too.

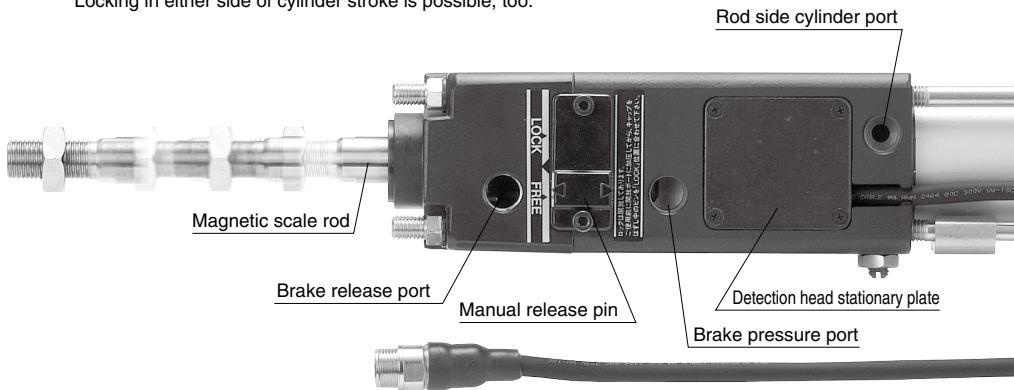

Working Principle of Brake Mechanism

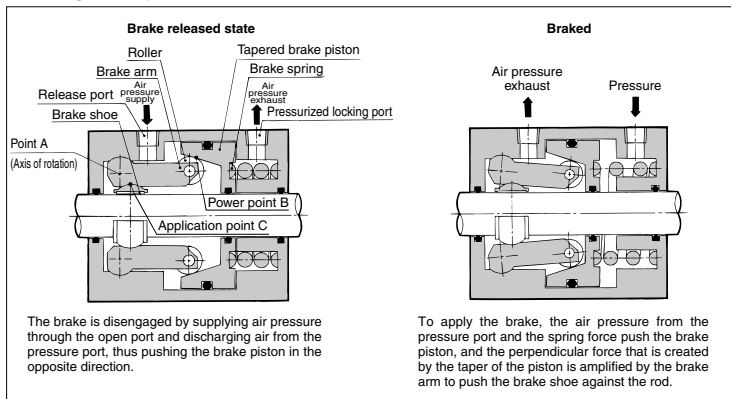

ø40, ø50, ø63, ø80, ø100

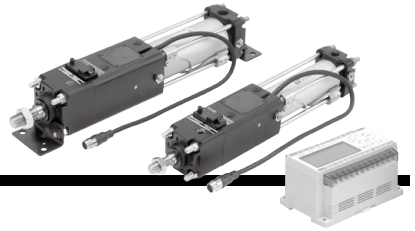

System configuration

Stroke reading cylinder with brake + Counter

- Prevents dropping from raised positions during intermediate stops.

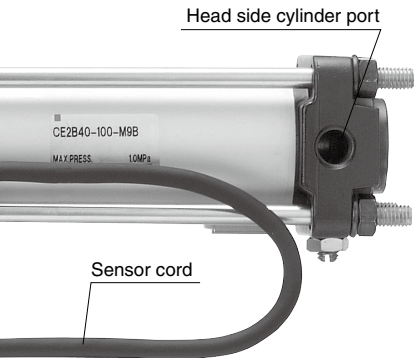

Multi-counter: Seriss CEU5

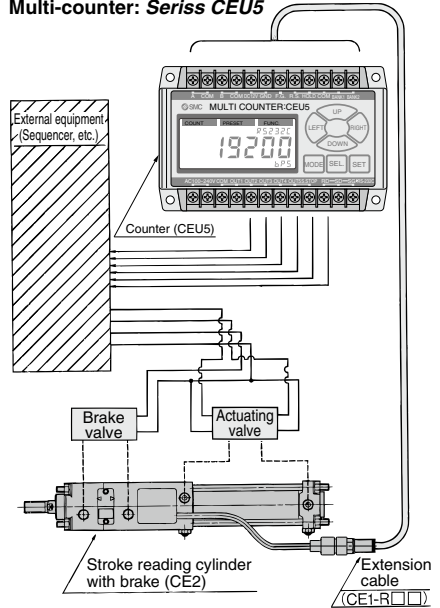

Measuring

Smallest measuring unit 0.1 mm

Magnetic scale rod and built-in detection head

Relation between displacement and output pulse on stroke reading cylinder

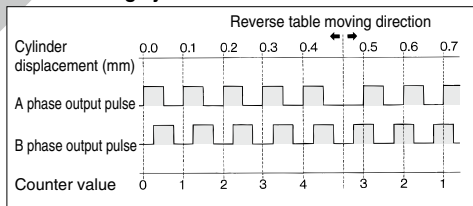

Flow Chart to Confirm Utility of Stroke Reading Cylinder with Brake

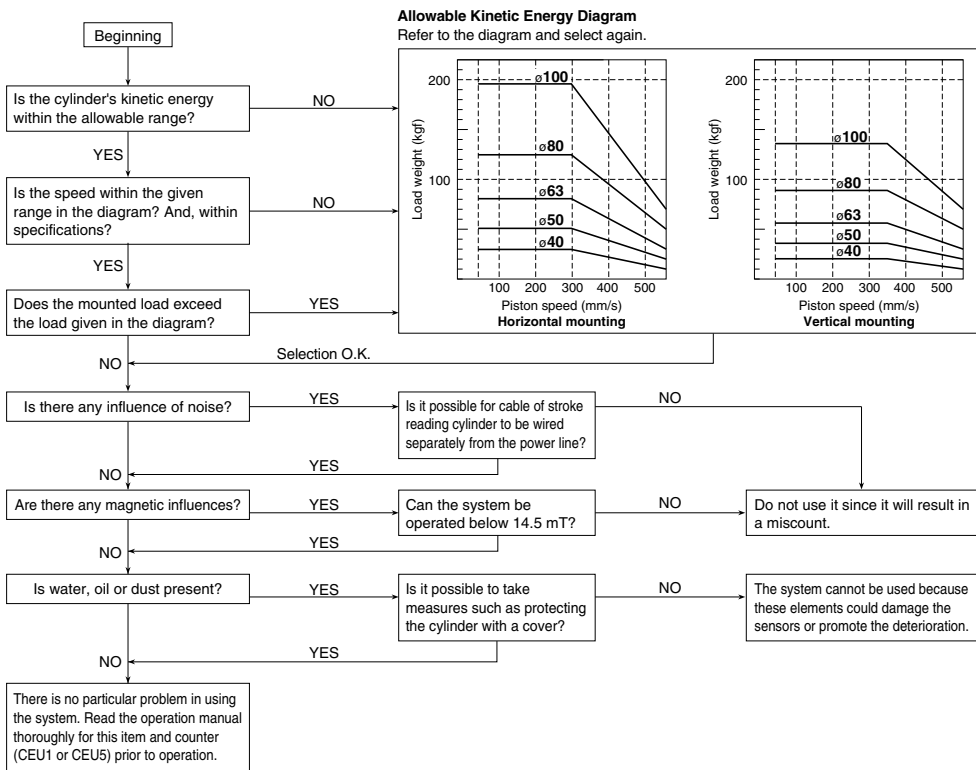

Example of Recommended Pneumatic Circuit

Horizontal mounting

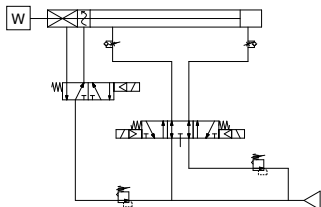

Vertical flat mounting

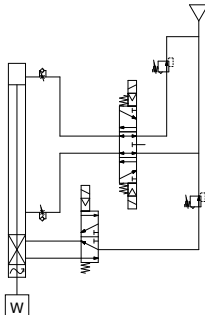

Vertical overhead mounting

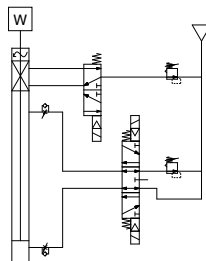

Note) In the case of light load, regulate head side supply pressure.
 * SMC original symbols are used for Stroke Reading Cylinder with Brake.

Recommended Pneumatic Equipment

| Bore size (mm) | Directional control valve | Brake valve | Regulator | Piping | Silencer | Speed controller |
|----------------|---------------------------|-------------|-----------|-------------------------|----------|------------------|
| ø40 | VFS24□OR | VFS21□O | AR425 | Nylon ø8/6 or larger | AN200-02 | AS4000-02 |
| ø50 | VFS24□OR | VFS21□O | AR425 | Nylon ø10/7.5 or larger | AN200-02 | AS4000-02 |
| ø63 | VFS34□OR | VFS21□O | AR425 | Nylon ø12/9 or larger | AN300-03 | AS4000-03 |
| ø80 | VFS44□OR | VFS31□O | AR425 | Nylon ø12/9 or larger | AN300-03 | AS420-03 |
| ø100 | VFS44□OR | VFS31□O | AR425 | Nylon ø12/9 or larger | AN400-04 | AS420-04 |

Caution on Pneumatic Circuit Design

Air balance

Unlike the current pneumatic cylinder that performs a simple reciprocal movement, the stroke reading cylinder with a brake also makes intermediate stops. Thus, it must maintain the proper air balance in a stopped state.

Therefore, the proper air balance must be established in accordance with the mounting orientation of the cylinder.

Use caution the piston rod may be lunched when the next motion gets started after the intermediate stops or commence the operation after the reverse motion gets done, unless the air balance is taken. It may result in degrading its accuracy.

Supply pressure

If line pressure is used directly as supply pressure, any fluctuation in pressure will appear in the form of changes in cylinder characteristics. Therefore, make sure to use a pressure regulator to convert line pressure into supply pressure (Drive: 0.1 to 1 MPa, Brake: 0.3 to 0.5 MPa) for the actuating valve and the brake valve. In order to actuate multiple cylinders at once, use a pressure regulator that can handle a large air flow volume and also consider installing a surge tank.

Stroke Reading Cylinder with Brake



(Note) CE/UKCA-compliant: When connecting to a multi-counter (CEU5□□-D, power supply voltage 24 VDC). Refer to the counter operation manual for details.

CE2 Series

ø40, ø50, ø63, ø80, ø100



How to Order

CE2 B 40 - **100** - **M9BW**

Mounting type

| | |
|---|-----------------------|
| B | Basic type |
| L | Foot type |
| F | Rod side flange type |
| G | Head side flange type |
| C | Single clevis type |
| D | Double clevis type |
| T | Center trunnion type |

Bore size

| | |
|-----|--------|
| 40 | 40 mm |
| 50 | 50 mm |
| 63 | 63 mm |
| 80 | 80 mm |
| 100 | 100 mm |

Port thread type

| | |
|-----|-----|
| Nil | Rc |
| TN | NPT |
| TF | G |

Number of auto switches

| | |
|-----|----------|
| Nil | 2 pcs. |
| S | 1 pc. |
| n | "n" pcs. |

Applicable counter

| |
|-------------|
| CEU5 series |
|-------------|

Suffix for cylinder

| | | |
|-----------|-----|---------------------------|
| Rod boot | J | Nylon tarpaulin |
| | K | Neoprene cross |
| Cushion | Nil | With cushion on both ends |
| | N | Without cushion |
| | R | With rod cushion |
| Connector | H | With head cushion |
| | Nil | With connector |
| | Z | Without connector |

Auto switch

| | |
|-----|---------------------------------------|
| Nil | Without auto switch (Built-in magnet) |
|-----|---------------------------------------|

* For the applicable auto switch model, refer to the table below.

Cylinder stroke (mm)

Refer to "Standard Stroke" on page 1093.

Applicable Auto Switches

Refer to pages 1341 to 1435 for further information on auto switches.

| Type | Special function | Electrical entry | Indicator light | Wiring (Output) | Load voltage | | Auto switch model | | Lead wire length (m) | | | | Pre-wired connector | Applicable load | | | | | | | | | | | | | | | | | | | | | |
|-------------------------|------------------|------------------|-------------------------|-----------------|--------------|-----------|-------------------|---------------|----------------------|-------------------------|--------------|------------------|---------------------|-----------------|---------------|------------|--------------|--------------|-----------|-----|-----|------|-----|------|-----|------|------------|------------|------------|------|------|--------|--------|--------|------|
| | | | | | DC | AC | Tie-rod mounting | Band mounting | 0.5 (Nil) | 1 (M) | 3 (L) | 5 (Z) | | IC circuit | Relay, PLC | | | | | | | | | | | | | | | | | | | | |
| | | | | | | | | | | | | | | | | M9N | G59 | M9P | G5P | M9B | K59 | G39C | G39 | K39C | K39 | M9NW | G59W | M9PW | G5PW | M9BW | K59W | M9NA*1 | M9PA*1 | M9BA*1 | F59F |
| Solid state auto switch | Grommet | Terminal conduit | Yes | 3-wire (NPN) | 24V | 5 V, 12 V | — | M9N | — | ● | ● | ● | ● | ○ | ○ | IC circuit | — | | | | | | | | | | | | | | | | | | |
| | | | | | | | | | | | | | | | | | | 3-wire (PNP) | 12 V | M9B | — | ● | ● | ● | ● | ○ | ○ | | | | | | | | |
| | | | | 2-wire | 12 V | G39C | G39 | — | — | — | — | — | — | — | — | — | | | | | | | | | | | | | | | | | | | |
| | | | | | | | | | | | | | | | | | 3-wire (NPN) | 24V | 5 V, 12 V | — | ● | ● | ● | ● | ○ | ○ | IC circuit | Relay, PLC | | | | | | | |
| | 3-wire (PNP) | 12 V | M9PW | — | ● | ● | ● | ● | ○ | ○ | | | | | | | | | | | | | | | | | | | | | | | | | |
| | | | | | | | | | | | 2-wire | 12 V | M9BW | — | ● | ● | ● | ● | ○ | ○ | — | — | | | | | | | | | | | | | |
| | Grommet | Terminal conduit | Yes | 3-wire (NPN) | 24V | 5 V, 12 V | — | M9NW | — | ● | | | | | | | | | | | | | ● | ● | ● | ○ | ○ | IC circuit | Relay, PLC | | | | | | |
| | | | | | | | | | | | 3-wire (PNP) | 12 V | M9PW | — | ● | ● | ● | ● | ○ | ○ | | | | | | | | | | | | | | | |
| | 2-wire | 12 V | M9BW | — | ● | ● | ● | ● | ○ | ○ | | | | | | | | | | | — | — | | | | | | | | | | | | | |
| | | | | | | | | | | | Grommet | Terminal conduit | Yes | 3-wire (NPN) | 24V | 5 V, 12 V | — | M9NA*1 | — | ○ | | | ○ | ○ | ○ | ○ | — | — | | | | | | | |
| 3-wire (PNP) | 12 V | M9PA*1 | — | ○ | ○ | ○ | ○ | ○ | ○ | | | | | | | | | | | | | | | | | | | | | | | | | | |
| | | | | | | | | | | 2-wire | 12 V | M9BA*1 | — | ○ | ○ | ○ | ○ | ○ | ○ | — | — | | | | | | | | | | | | | | |
| Grommet | Terminal conduit | Yes | 4-wire (NPN) | 24V | 5 V, 12 V | — | F59F | G59F | ● | | | | | | | | | | | | | — | ● | ● | ○ | ○ | IC circuit | — | | | | | | | |
| | | | | | | | | | | 3-wire (NPN equivalent) | 12 V | A96** | — | ● | — | ● | — | — | — | — | — | | | | | | | | — | — | | | | | |
| Grommet | Terminal conduit | No | 3-wire (NPN equivalent) | 24V | 12 V | 100 V | A93** | — | ● | | | | | | | | | | | | | ● | ● | ● | — | — | IC circuit | Relay, PLC | | | | | | | |
| | | | | | | | | | | Grommet | DIN terminal | Yes | 2-wire | 12 V | 100 V or less | A90** | — | ● | — | — | — | | | | | | | | — | — | — | | | | |
| Grommet | DIN terminal | Yes | 2-wire | 12 V | 100 V, 200 V | A54 | B54 | ● | — | | | | | | | | | | | | | ● | ● | — | — | — | | | | | | | | | |
| | | | | | | | | | | Grommet | DIN terminal | Yes | 2-wire | 12 V | 200 V or less | A64 | B64 | ● | — | ● | — | | | | | | — | — | — | | | | | | |
| Grommet | DIN terminal | Yes | 2-wire | 12 V | 100 V, 200 V | A33C | A33 | — | — | | | | | | | | | | | | | — | — | — | — | — | | | | | | | | | |
| | | | | | | | | | | Grommet | DIN terminal | Yes | 2-wire | 12 V | 100 V, 200 V | A34C | A34 | — | — | — | — | | | | | | — | — | — | | | | | | |
| Grommet | DIN terminal | Yes | 2-wire | 12 V | 100 V, 200 V | A44C | A44 | — | — | | | | | | | | | | | | | — | — | — | — | — | | | | | | | | | |
| | | | | | | | | | | Grommet | DIN terminal | Yes | 2-wire | 12 V | 100 V, 200 V | A59W | B59W | ● | — | ● | — | | | | | | — | — | — | | | | | | |

*1 Water resistant type auto switches can be mounted on the above models, but in such case SMC cannot guarantee water resistance. Consult with SMC regarding water resistant types with the above model numbers.
 * Lead wire length symbols: 0.5 m..... Nil (Example) M9NW
 1 m..... M (Example) M9NWM
 3 m..... L (Example) M9NWL
 5 m..... Z (Example) M9NWZ
 * Solid state auto switches marked with "○" are produced upon receipt of order.
 ** Since D-A9□ and D-A9□V cannot be mounted on ø50, use of D-Z7□ or D-Z80 is recommended.

* Since there are other applicable auto switches than listed, refer to page 1103 for details.
 * For details about auto switches with pre-wired connector, refer to pages 1410 and 1411.
 * D-A9□/M9□/M9□W/M9□A(V) auto switches are shipped together (not assembled). (Only auto switch mounting brackets are assembled before shipped.)



Stroke Reading Cylinder with Brake **CE2 Series**

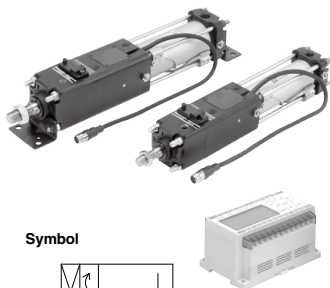

Symbol

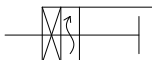

Model

| Series | Type | Action | Bore size (mm) | Lock action |
|--------|----------|---------------|---------------------|---------------------------|
| CE2 | Non-lube | Double acting | 40, 50, 63, 80, 100 | Spring and pneumatic lock |

Rod Boot Material

| Symbol | Rod boot material | Maximum ambient temperature |
|--------|-------------------|-----------------------------|
| J | Nylon tarpaulin | 60°C |
| K | Neoprene cross | 110°C* |

* Maximum ambient temperature for the rod boot itself.

As for multi counter, it will be common to CEP1 and CE1 series. For details, refer to Multi counter/CEU5 on page 1075 respectively.

- Refer to pages 1098 to 1103 for cylinders with auto switches.
- Auto switch proper mounting position (detection at stroke end) and its mounting height
 - Operating range
 - Minimum stroke for auto switch mounting
 - Auto switch mounting brackets/Part no.

Cylinder Specifications

| Bore size (mm) | | ø40 | ø50 | ø63 | ø80 | ø100 |
|----------------------------|-------|---|-----|-----|-----|------|
| Fluid | | Air (Non-lube) | | | | |
| Proof pressure | Drive | 1.5 MPa | | | | |
| | Brake | 0.75 MPa | | | | |
| Maximum operating pressure | Drive | 1 MPa | | | | |
| | Brake | 0.5 MPa | | | | |
| Minimum operating pressure | Drive | 0.1 MPa | | | | |
| | Brake | 0.3 MPa | | | | |
| Piston speed | | 50 to 500 mm/s* | | | | |
| Ambient temperature | | 00 to 60°C (No freezing) | | | | |
| Brake system | | Spring and pneumatic lock type | | | | |
| Sensor cord length | | ø7-500 mm Oil-resistant | | | | |
| Stroke length tolerance | | Up to 250 mm: $\begin{smallmatrix} +1.0 \\ 0 \end{smallmatrix}$; 251 mm to 1000 mm $\begin{smallmatrix} +1.4 \\ 0 \end{smallmatrix}$ | | | | |

* Be aware of the constraints in the allowable kinetic energy.

Sensor Specifications

| | |
|-------------------------------|---|
| Cable | ø7, 6 core twisted pair shielded wire (Oil, Heat and Flame resistant cable) |
| Maximum transmission distance | 20.5 m (when using SMC cable while using controller or counter) |
| Position detection method | Magnetic scale rod/Sensor head <Incremental type> |
| Magnetic field resistance | 14.5 mT |
| Power supply | 10.8 to 26.4 VDC (Power supply ripple: 1% or less) |
| Current consumption | 50 mA |
| Resolution | 0.1 mm/pulse |
| Accuracy | ± 0.2 mm (Note) |
| Output type | Open collector (Max. 30 VDC, 50 mA) |
| Output signal | A/B phase difference output |
| Insulation resistance | 50 MΩ or more (500 VDC measured via megohmmeter) (between case and 12E) |
| Vibration resistance | 33.3 Hz, 6.8 G 2 hrs. each in X, Y directions 4 hrs. in Z direction based upon JIS D 1601 |
| Impact resistance | 30 G, 3 times at X, Y, Z |
| Enclosure | IP65 (IEC standard) Except connector part |
| Extension cable (Option) | 5 m, 10 m, 15 m, 20 m |

Note) Digital error under Counter (CEU5) is included. Besides, the whole accuracy after mounting on an equipment may be varied depending on the mounting condition and surroundings. As an equipment, calibration should be done by customer.

Standard Stroke

| Bore size (mm) | Standard stroke (mm) | | Range of manufacturable stroke* | |
|----------------|----------------------|---------------|---------------------------------|---------------|
| | Without rod boot | With rod boot | Without rod boot | With rod boot |
| 40 | 25 to 850 | 25 to 700 | Up to 1200 | Up to 950 |
| 50 | 25 to 800 | 25 to 650 | Up to 1150 | Up to 900 |
| 63 | 25 to 800 | 25 to 650 | Up to 1150 | Up to 900 |
| 80 | 25 to 750 | 25 to 600 | Up to 1100 | Up to 900 |
| 100 | 25 to 750 | 25 to 600 | Up to 1100 | Up to 850 |

* Strokes longer than the standard stroke are made-to-order products.

* Applicable strokes should be confirmed according to the usage. For details, refer to "CA2 Series" in the Air Cylinders Model Selection on the **Web Catalog**.

Weight

| Bore size (mm) | | 40 | 50 | 63 | 80 | 100 |
|--|--------------------|------|------|------|-------|-------|
| Basic weight | Basic type | 2.18 | 3.39 | 5.29 | 8.66 | 12.09 |
| | Foot type | 2.37 | 3.61 | 5.63 | 9.33 | 13.08 |
| | Flange type | 2.55 | 3.84 | 6.08 | 10.11 | 14.01 |
| | Single clevis type | 2.41 | 3.73 | 5.92 | 9.77 | 13.87 |
| | Double clevis type | 2.45 | 3.82 | 6.08 | 10.06 | 14.39 |
| | Trunnion type | 3.63 | 3.92 | 6.18 | 10.36 | 14.49 |
| Additional weight per each 50 mm of stroke | Aluminum tube | 0.22 | 0.28 | 0.37 | 0.52 | 0.65 |
| | Mounting bracket | | | | | |
| Accessory bracket | Single knuckle | 0.23 | 0.26 | 0.26 | 0.60 | 0.83 |
| | Double knuckle | 0.32 | 0.38 | 0.38 | 0.73 | 1.08 |
| | Knuckle pin | 0.05 | 0.05 | 0.05 | 0.14 | 0.19 |

Calculation example: **CE2L40-100**

• Basic weight.....2.37 (Foot type, ø40)

• Additional weight.....0.22/50 stroke

• Cylinder stroke.....100 stroke

2.37 + 0.22 x 100/50 = 2.81 kg

Accessories

| Mounting | | Basic | Axial foot | Rod flange | Head flange | Single clevis | Double clevis | Center trunnion |
|----------|---------------------------------|-------|------------|------------|-------------|---------------|---------------|-----------------|
| Standard | Rod end nut | ● | ● | ● | ● | ● | ● | ● |
| | Clevis pin | — | — | — | — | — | ● | — |
| Option | Single knuckle joint | ● | ● | ● | ● | ● | ● | ● |
| | Double knuckle joint (with pin) | ● | ● | ● | ● | ● | ● | ● |
| | With rod boot | ● | ● | ● | ● | ● | ● | ● |

* Refer to page 1097 for dimensions and part numbers of the option. Refer to page 1095 for dimensions of the rod boot.

CE2 Series

Construction

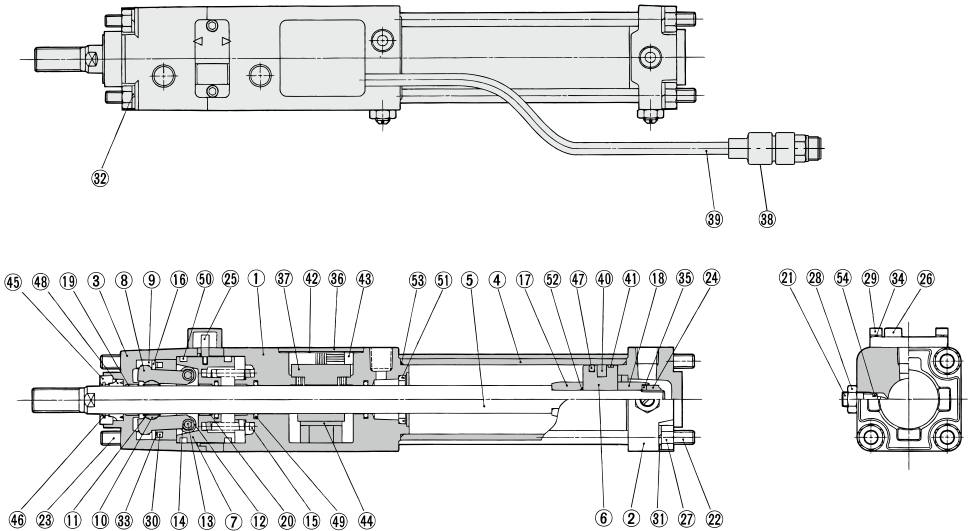

Component parts

| No. | Description | Material | Note |
|-----|-----------------------|---------------------------|-----------------------------------|
| 1 | Rod cover | Aluminum alloy | Black painted after hard anodized |
| 2 | Head cover | Aluminum alloy | Black painted |
| 3 | Cover | Aluminum alloy | Black painted after hard anodized |
| 4 | Cylinder tube | Aluminum alloy | Hard anodized |
| 5 | Piston rod | Free-cutting steel | Hard chrome plated |
| 6 | Piston | Aluminum alloy | Chromated |
| 7 | Brake piston | Carbon steel | Nitriding |
| 8 | Brake arm | Carbon steel | Nitriding |
| 9 | Brake arm holder | Carbon steel | Nitriding |
| 10 | Brake shoe holder | Carbon steel | Nitriding |
| 11 | Brake shoe | Special friction material | |
| 12 | Roller | Chromium molybdenum steel | Nitriding |
| 13 | Pin | Chrome bearing steel | Heat treated |
| 14 | Type E retaining ring | Stainless steel | JIS B 2805E |
| 15 | Brake spring | Steel wire | Dacrodized |
| 16 | Retaining plate | Rolled steel plate | Zinc chromated |
| 17 | Cushion ring A | Rolled steel | Electroless nickel plated |
| 18 | Cushion ring B | Rolled steel | Electroless nickel plated |
| 19 | Bushing | Lead-bronze casted | |
| 20 | Bushing | Lead-bronze casted | |
| 21 | Cushion valve | Rolled steel plate | Electroless nickel plated |
| 22 | Tie-rod | Carbon steel | Chromated |
| 23 | Unit holding tie-rod | Carbon steel | Chromated |
| 24 | Piston nut | Rolled steel plate | Zinc chromated |
| 25 | Non-rotating pin | Carbon steel | High frequency quenched |
| 26 | Pin guide | Carbon steel | Black painted after nitriding |
| 27 | Tie-rod nut | Carbon steel | Black zinc chromated |

| No. | Description | Material | Note |
|-----|-------------------------------|---------------------------|----------------------|
| 28 | Lock nut | Carbon steel | Nickel plated |
| 29 | Hexagon socket head cap screw | Chromium molybdenum steel | Black zinc chromated |
| 30 | Hexagon socket head cap screw | Stainless steel | |
| 31 | Spring washer | Steel wire | Black zinc chromated |
| 32 | Spring washer | Steel wire | Black zinc chromated |
| 33 | Spring washer | Steel wire | Black zinc chromated |
| 34 | Spring washer | Steel wire | Black zinc chromated |
| 35 | Spring washer | Steel wire | Zinc chromated |
| 36 | Sensor cover | Carbon steel | |
| 37 | Detection head assembly | — | |
| 38 | Connector | — | |
| 39 | Cable | — | |
| 40 | Rubber magnet | NBR | |
| 41 | Wear ring | Resin | |
| 42 | Gasket | NBR | |
| 43 | Bushing | NBR | |
| 44 | Amp cushion | NBR | |
| 45 | Seal retainer | Aluminum alloy | |
| 46 | Coil scraper | Phosphor bronze | |
| 47 | Piston seal | NBR | |
| 48 | Rod seal A | NBR | |
| 49 | Rod seal B | NBR | |
| 50 | Brake piston seal | NBR | |
| 51 | Cushion seal | NBR | |
| 52 | Piston gasket | NBR | |
| 53 | Cylinder tube gasket | NBR | |
| 54 | Cushion valve seal | NBR | |

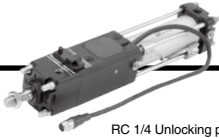

Dimensions: $\varnothing 40$ to $\varnothing 100$

Basic type

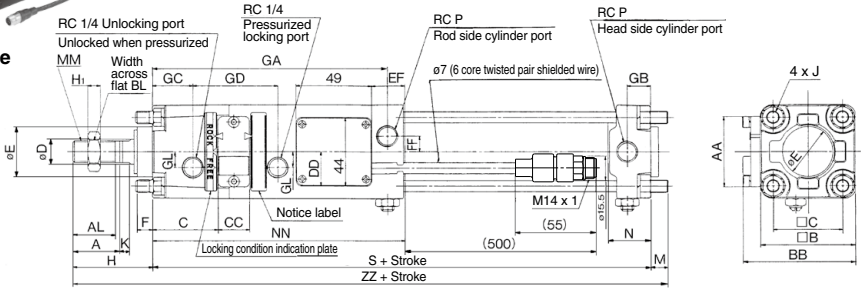

With rod boot

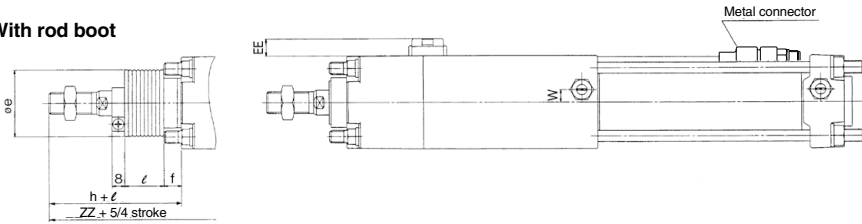

(mm)

| Bore size (mm) | Stroke range | | A | AA | AL | BB | BL | □B | C | CC | □C | DD | D | EF | EE | E | F | FF | GA | GB | GC | GD | GL | H ₁ | J | K | M |
|----------------|------------------|---------------|----|----|----|-------|----|-----|------|----|----|------|----|------|------|----|----|----|-------|----|----|----|----|----------------|------------|----|----|
| | Without rod boot | With rod boot | | | | | | | | | | | | | | | | | | | | | | | | | |
| 40 | 25 to 850 | 25 to 700 | 30 | 45 | 27 | 71.5 | 22 | 60 | 42 | 20 | 44 | 22 | 16 | 21 | 11.5 | 32 | 10 | 10 | 150.5 | 15 | 26 | 54 | 10 | 8 | M8 x 1.25 | 6 | 11 |
| 50 | 25 to 800 | 25 to 650 | 35 | 50 | 32 | 80.5 | 27 | 70 | 46 | 21 | 52 | 24 | 20 | 28.5 | 10.5 | 40 | 10 | 12 | 162.5 | 17 | 27 | 59 | 13 | 11 | M8 x 1.25 | 9 | 11 |
| 63 | 25 to 800 | 25 to 650 | 35 | 60 | 32 | 98.5 | 27 | 85 | 48.5 | 23 | 64 | 24 | 20 | 28.5 | 13.5 | 40 | 10 | 15 | 174 | 17 | 26 | 67 | 18 | 11 | M10 x 1.25 | 9 | 14 |
| 80 | 25 to 750 | 25 to 600 | 40 | 70 | 37 | 117.5 | 32 | 102 | 55 | 23 | 78 | 26.5 | 25 | 36 | 15.5 | 52 | 14 | 17 | 189 | 21 | 30 | 72 | 23 | 13 | M12 x 1.75 | 11 | 17 |
| 100 | 25 to 750 | 25 to 600 | 40 | 80 | 37 | 131.5 | 41 | 116 | 56.5 | 25 | 92 | 35.5 | 30 | 36 | 15.5 | 52 | 14 | 19 | 198 | 21 | 31 | 76 | 25 | 16 | M12 x 1.75 | 11 | 17 |

| Bore size (mm) | MM | N | NN | P | S | W | Without rod boot | | With rod boot | | | | |
|----------------|-----------|----|-------|-----|-------|---|------------------|-------|---------------|------|----|-------|----|
| | | | | | | | H | ZZ | e | f | h | ℓ | ZZ |
| 40 | M14 x 1.5 | 27 | 161.5 | 1/4 | 218.5 | 8 | 51 | 280.5 | 43 | 11.2 | 59 | | |
| 50 | M18 x 1.5 | 30 | 175.5 | 3/8 | 235.5 | 0 | 58 | 304.5 | 52 | 11.2 | 66 | 312.5 | |
| 63 | M18 x 1.5 | 31 | 187 | 3/8 | 254 | 0 | 58 | 326 | 52 | 11.2 | 66 | 334 | |
| 80 | M22 x 1.5 | 37 | 205 | 1/2 | 284 | 0 | 71 | 372 | 65 | 12.5 | 80 | 381 | |
| 100 | M26 x 1.5 | 40 | 214 | 1/2 | 300 | 0 | 72 | 389 | 65 | 14 | 81 | 398 | |

Foot type

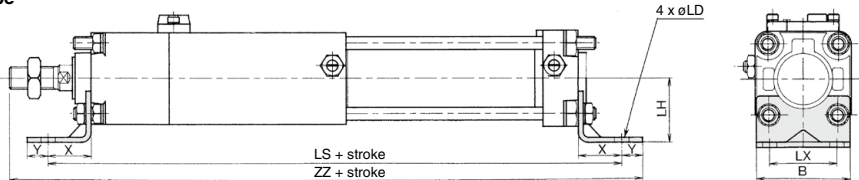

(mm)

| Bore size (mm) | B | LH | LS | LX | X | Y | ZZ | LD |
|----------------|------|----|-------|----|----|----|-------|------|
| 40 | 58.5 | 40 | 272.5 | 42 | 27 | 13 | 309.5 | 9 |
| 50 | 68.5 | 45 | 289.5 | 50 | 27 | 13 | 333.5 | 9 |
| 63 | 83 | 50 | 322 | 59 | 34 | 16 | 362 | 11.5 |
| 80 | 100 | 65 | 372 | 76 | 44 | 16 | 415 | 13.5 |
| 100 | 114 | 75 | 386 | 92 | 43 | 17 | 432 | 13.5 |

CE2 Series

Dimensions: $\varnothing 40$ to $\varnothing 100$

Rod side flange type

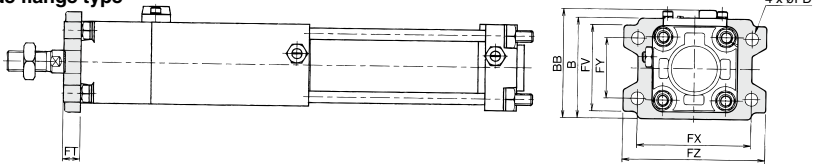

Head side flange type

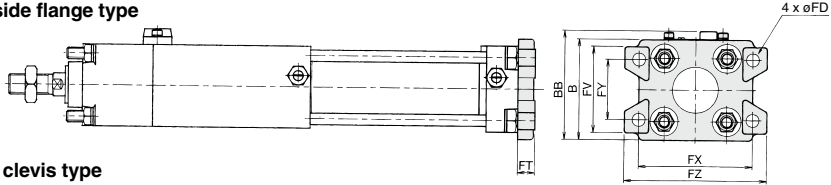

Single clevis type

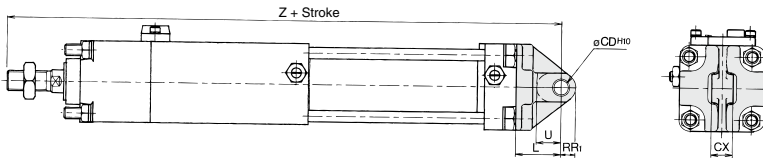

Double clevis type

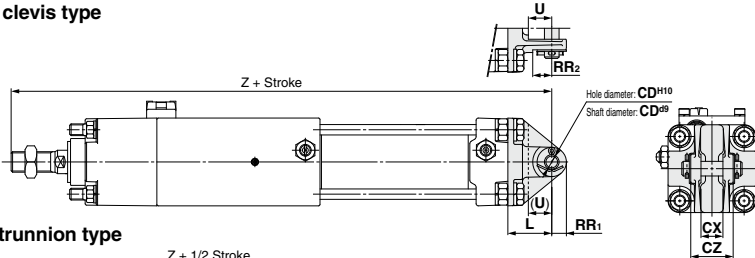

Center trunnion type

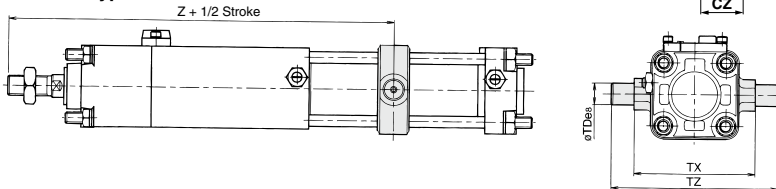

(mm)

| Bore size (mm) | Rod side flange, Head side flange | | | | | | Rod side flange | | | | | | Single clevis, Double clevis | | | | | Single clevis | | | Double clevis | | | Center trunnion | | |
|-------------------|-----------------------------------|-----|-----|----|-----|------|-----------------|-----|-------------------------------------|----|-----------------|-----------------|------------------------------|-------|--|--|------|--|-----|-----|---------------|--|--|-----------------|--|--|
| | FT | FV | FX | FY | FZ | FD | B | BB | CD ^{H10} | L | RR ₁ | RR ₂ | U | Z | CX | CX | CZ | TDe8 | TX | TZ | Z | | | | | |
| 40 | 12 | 60 | 80 | 42 | 100 | 9 | 71 | 77 | 10 ^{+0.058} / ₀ | 30 | 10 | 16 | 16 | 299.5 | 15 ^{+0.1} / _{-0.1} | 15 ^{+0.1} / _{-0.1} | 29.5 | 15 ^{-0.032} / _{-0.059} | 85 | 117 | 227.5 | | | | | |
| 50 | 12 | 70 | 90 | 50 | 110 | 9 | 81 | 86 | 12 ^{+0.070} / ₀ | 35 | 12 | 19 | 19 | 328.5 | 18 ^{-0.1} / _{-0.3} | 18 ^{+0.3} / _{-0.1} | 38 | 15 ^{-0.032} / _{-0.059} | 95 | 127 | 248.5 | | | | | |
| 63 | 15 | 86 | 105 | 59 | 130 | 11.5 | 101 | 107 | 16 ^{+0.070} / ₀ | 40 | 16 | 23 | 23 | 352 | 25 ^{-0.1} / _{-0.3} | 25 ^{+0.3} / _{-0.1} | 49 | 18 ^{-0.032} / _{-0.059} | 110 | 148 | 263 | | | | | |
| 80 | 18 | 102 | 130 | 76 | 160 | 13.5 | 119 | 126 | 20 ^{+0.084} / ₀ | 48 | 20 | 28 | 28 | 403 | 31.5 ^{-0.1} / _{-0.3} | 31.5 ^{+0.3} / _{-0.1} | 61 | 25 ^{-0.040} / _{-0.073} | 140 | 192 | 297 | | | | | |
| 100 | 18 | 116 | 150 | 92 | 180 | 13.5 | 133 | 140 | 25 ^{+0.084} / ₀ | 58 | 25 | 23.5 | 36 | 430 | 35.5 ^{-0.1} / _{-0.3} | 35.5 ^{+0.3} / _{-0.1} | 64 | 25 ^{-0.040} / _{-0.073} | 162 | 214 | 309 | | | | | |

Mounting Bracket Part No.

| Bore size (mm) | 40 | 50 | 63 | 80 | 100 |
|-----------------|---------|---------|---------|---------|---------|
| Axial foot* | CA2-L04 | CA2-L05 | CA2-L06 | CA2-L08 | CA2-L10 |
| Flange | CA2-F04 | CA2-F05 | CA2-F06 | CA2-F08 | CA2-F10 |
| Single clevis | CA2-C04 | CA2-C05 | CA2-C06 | CA2-C08 | CA2-C10 |
| Double clevis** | CA2-D04 | CA2-D05 | CA2-D06 | CA2-D08 | CA2-D10 |

* When axial foot brackets are used, order two pieces per cylinder.

** A clevis pin, flat washers and split pins are shipped together with double clevis.

Allowable Kinetic Energy

Operate the stroke reading cylinder with brake within the proper allowable kinetic energy. It must not be operated out of the allowable range, which is shown in the graph on the right. All sizes must be operated within this range. (Supply pressure 0.5 MPa)

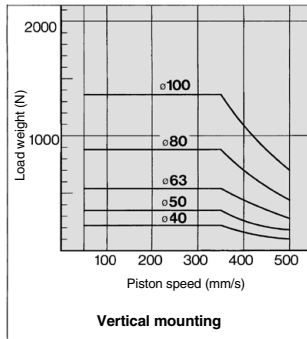
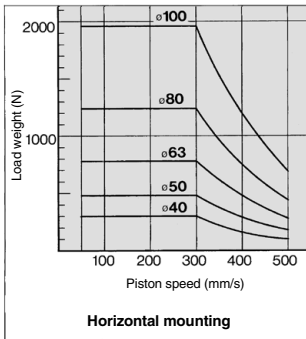

Dimensions of Accessories

Y Type Double Knuckle Joint

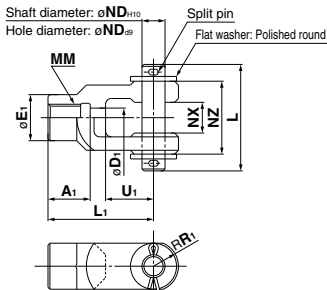

Material: Cast iron (mm)

| Part no. | Applicable bore size | A ₁ | E ₁ | D ₁ | L ₁ | MM | R ₁ | U ₁ | ND | NX | NZ | L | Split pin size | Flat washer size |
|----------|----------------------|----------------|----------------|----------------|----------------|-----------|----------------|----------------|----|--------------------------------------|----|------|----------------|-------------------|
| Y-04D | 40 | 22 | 24 | 10 | 55 | M14 x 1.5 | 13 | 25 | 12 | 16 ^{+0.3} / _{+0.1} | 38 | 55.5 | ø3 x 18 L | Polished round 12 |
| Y-05D | 50, 63 | 27 | 28 | 14 | 60 | M18 x 1.5 | 15 | 27 | 12 | 16 ^{+0.3} / _{+0.1} | 38 | 55.5 | ø3 x 18 L | Polished round 12 |
| Y-08D | 80 | 37 | 36 | 18 | 71 | M22 x 1.5 | 19 | 28 | 18 | 28 ^{+0.3} / _{+0.1} | 55 | 76.5 | ø4 x 25 L | Polished round 18 |
| Y-10D | 100 | 37 | 40 | 21 | 83 | M26 x 1.5 | 21 | 38 | 20 | 30 ^{+0.3} / _{+0.1} | 61 | 83 | ø4 x 30 L | Polished round 20 |

* A knuckle pin, split pins and flat washers are included.

Clevis Pin/Knuckle Pin

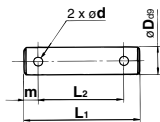

Material: Carbon steel (mm)

| Part no. | Applicable bore size | | Dd9 | L ₁ | L ₂ | m | d | Included split pin | Included flat washer |
|----------|----------------------|------------|--|----------------|----------------|---|---|--------------------|----------------------|
| | Clevis | Knuckle | | | | | | | |
| CDP-2A | 40 | — | 10 ^{-0.040} / _{-0.076} | 46 | 38 | 4 | 3 | ø3 x 18 L | Polished round 10 |
| CDP-3A | 50 | 40, 50, 63 | 12 ^{-0.050} / _{-0.093} | 55.5 | 47.5 | 4 | 3 | ø3 x 18 L | Polished round 12 |
| CDP-4A | 63 | — | 16 ^{-0.050} / _{-0.093} | 71 | 61 | 5 | 4 | ø4 x 25 L | Polished round 16 |
| CDP-5A | — | 80 | 18 ^{-0.050} / _{-0.093} | 76.5 | 66.5 | 5 | 4 | ø4 x 25 L | Polished round 18 |
| CDP-6A | 80 | 100 | 20 ^{-0.065} / _{-0.117} | 83 | 73 | 5 | 4 | ø4 x 30 L | Polished round 20 |
| CDP-7A | 100 | — | 25 ^{-0.065} / _{-0.117} | 88 | 78 | 5 | 4 | ø4 x 36 L | Polished round 24 |

* Split pins and flat washers are included.

I Type Single Knuckle Joint

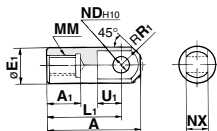

Material: Free cutting sulfur steel (mm)

| Part no. | Applicable bore size | A | A ₁ | E ₁ | L ₁ | MM | R ₁ | U ₁ | ND _{H10} | NX |
|----------|----------------------|-----|----------------|----------------|----------------|-----------|----------------|----------------|-------------------------------------|--------------------------------------|
| I-04A | 40 | 69 | 22 | 24 | 55 | M14 x 1.5 | 15.5 | 20 | 12 ^{+0.070} / ₀ | 16 ^{-0.1} / _{-0.3} |
| I-05A | 50, 63 | 74 | 27 | 28 | 60 | M18 x 1.5 | 15.5 | 20 | 12 ^{+0.070} / ₀ | 16 ^{-0.1} / _{-0.3} |
| I-08A | 80 | 91 | 37 | 36 | 71 | M22 x 1.5 | 22.5 | 26 | 18 ^{+0.070} / ₀ | 28 ^{-0.1} / _{-0.3} |
| I-10A | 100 | 105 | 37 | 40 | 83 | M26 x 1.5 | 24.5 | 28 | 20 ^{+0.084} / ₀ | 30 ^{-0.1} / _{-0.3} |

Rod End Nut (Standard)

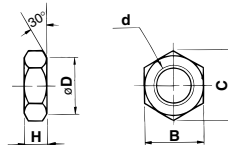

Material: Rolled steel (mm)

| Part no. | Applicable bore size | d | H | B | C | D |
|----------|----------------------|-----------|----|----|------|----|
| NT-04 | 40 | M14 x 1.5 | 8 | 22 | 25.4 | 21 |
| NT-05 | 50, 63 | M18 x 1.5 | 11 | 27 | 31.2 | 26 |
| NT-08 | 80 | M22 x 1.5 | 13 | 32 | 37.0 | 31 |
| NT-10 | 100 | M26 x 1.5 | 16 | 41 | 47.3 | 39 |

Auto Switch Mounting 1

Auto Switch Proper Mounting Position (Detection at Stroke End) and Its Mounting Height

<Band mounting>

D-B5□/B64/B59W

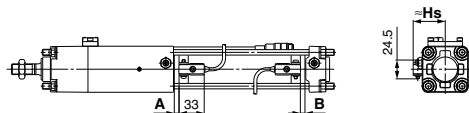

D-A3□
D-G39/K39

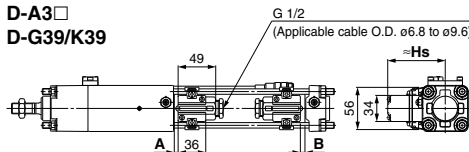

D-G5□/K59
D-G5□W/K59W
D-G5BA
D-G59F/G5NT

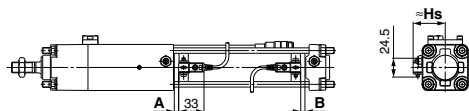

D-A44

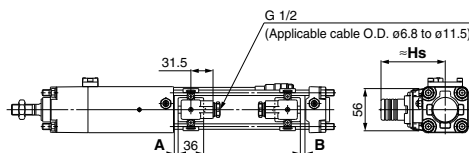

<Tie-rod mounting>

D-A9□/A9□V D-Z7□/Z8□
D-M9□/M9□V D-Y59□/Y69□/Y7P/Y7PV
D-M9□W/M9□WV D-Y7□W/Y7□WV
D-M9□A/M9□AV D-Y7BA

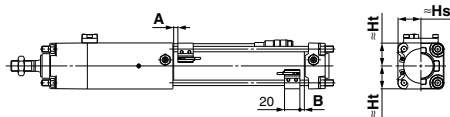

D-A5□/A6□
D-A59W

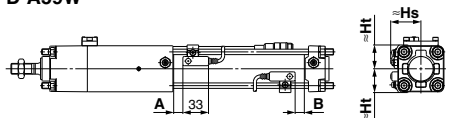

D-A3□C
D-G39C/K39C

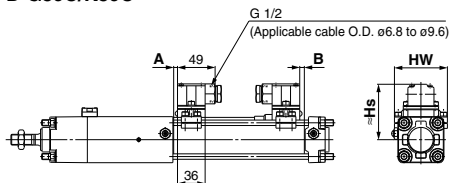

D-F5□/J59
D-F5NT
D-F5□W/J59W
D-F5BA/F59F

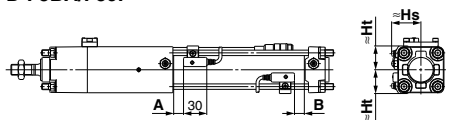

D-A44C

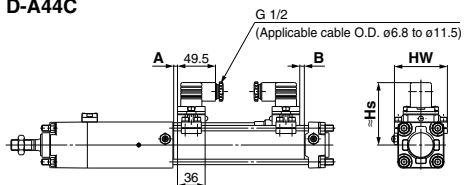

Auto Switch Proper Mounting Position (Detection at Stroke End) and Its Mounting Height

Auto Switch Proper Mounting Position

(mm)

| Auto switch model | D-A9□ D-A9□V | | D-M9□ D-M9□V D-M9□W D-M9□WV D-M9□A D-M9□AV | | D-B59W D-Z7□ D-Z80 D-Y59□ D-Y69□ D-Y7P D-Y7PV D-Y7□WV D-Y7BA | | D-A5□ D-A6□ D-A3□ D-A3□C D-A44 D-A44C D-G39 D-G39C D-K39 D-K39C | | D-B5□ D-B64 | | D-F5□ D-J59 D-F59F D-F5□W D-J59W D-F5BA | | D-G5□ D-K59 D-G5NT D-G5□W D-K59W D-G5BA D-G59F | | D-A59W | | D-F5NT | |
|-------------------|-----------------|------|---|------|--|-----|--|-----|----------------|-----|--|-----|--|-----|--------|------|--------|-----|
| | A | B | A | B | A | B | A | B | A | B | A | B | A | B | A | B | A | B |
| 40 | 6 | 4 | 10 | 8 | 3.5 | 1.5 | 0 | 0 | 0.5 | 0 | 6.5 | 4.5 | 2 | 0 | 4 | 2 | 11.5 | 9.5 |
| 50 | — | — | 10 | 8 | 3.5 | 1.5 | 0 | 0 | 0.5 | 0 | 6.5 | 4.5 | 2 | 0 | 4 | 2 | 11.5 | 9.5 |
| 63 | 8.5 | 7.5 | 12.5 | 11.5 | 6 | 5 | 2.5 | 1.5 | 3 | 2 | 9 | 8 | 4.5 | 3.5 | 6.5 | 5.5 | 14 | 13 |
| 80 | 12 | 10 | 16 | 14 | 9.5 | 7.5 | 6 | 4 | 6.5 | 4.5 | 12.5 | 8 | 6 | 10 | 8 | 17.5 | 15.5 | |
| 100 | 13.5 | 12.5 | 17.5 | 16.5 | 11 | 10 | 7.5 | 6.5 | 8 | 7 | 14 | 13 | 9.5 | 8.5 | 11.5 | 10.5 | 19 | 18 |

* D-A9□ and D-A9□V cannot be mounted on ø50.

Note) Adjust the auto switch after confirming the operating conditions in the actual setting.

Auto Switch Mounting Height

(mm)

| Auto switch model | D-A9□ D-M9□ D-M9□W D-M9□A | | D-A9□V | | D-M9□V D-M9□WV D-M9□AV | | D-Z7□ D-Z80 D-Y59□ D-Y7P D-Y7BA D-Y7□W | | D-Y69□ D-Y7PV D-Y7□WV | | D-B5□ D-B64 D-B59W D-G5□ D-K59 D-G5NT D-G5□W D-K59W D-G5BA D-G59F | | D-A3□ D-G39 D-K39 | | D-A44 | | D-A5□ D-A6□ D-A59W | | D-F5□ D-J59 D-F5□W D-J59W D-F5BA D-F59F D-F5NT | | D-A3□C D-G39C D-K39C | | D-A44C | |
|-------------------|------------------------------------|----|--------|----|------------------------------|----|---|------|-----------------------------|------|--|------|-------------------------|------|-------|------|--------------------------|------|--|------|----------------------------|----|--------|--|
| | Hs | Ht | Hs | Ht | Hs | Ht | Hs | Ht | Hs | Ht | Hs | Ht | Hs | Ht | Hs | Ht | Hs | Ht | Hs | Hw | Hs | Hw | | |
| 40 | 30 | 30 | 32 | 30 | 35 | 30 | 30 | 30 | 30 | 30.5 | 30 | 38 | 72.5 | 80.5 | 40 | 31 | 38.5 | 31 | 73 | 69 | 81 | 69 | | |
| 50 | 34 | 34 | 36.5 | 34 | 39 | 34 | 34 | 34 | 35 | 34 | 43.5 | 78 | 86 | 43.5 | 35 | 42.5 | 35 | 78.5 | 77 | 86.5 | 77 | | | |
| 63 | 41 | 41 | 43.5 | 41 | 46 | 41 | 41 | 41 | 42.5 | 41 | 50.5 | 85 | 93 | 49 | 42 | 48 | 42 | 85.5 | 91 | 93.5 | 91 | | | |
| 80 | 49.5 | 49 | 51.5 | 49 | 54 | 49 | 49.5 | 48.5 | 51 | 48.5 | 59 | 93.5 | 101.5 | 55.5 | 50 | 54 | 50 | 94 | 107 | 102 | 107 | | | |
| 100 | 57 | 56 | 59.5 | 56 | 62.5 | 56 | 58.5 | 56 | 59 | 56 | 69.5 | 104 | 112 | 63 | 57.5 | 62 | 57.5 | 104 | 121 | 112 | 121 | | | |

* D-A9□ and D-A9□V cannot be mounted on ø50.

Minimum Auto Switch Mounting Stroke

| | | n: No. of auto switches (mm) | | | | | |
|--|--|--|--|---|---|--|---|
| Auto switch model | No. of auto switch mounted | Mounting brackets other than center trunnion | Center trunnion | | | | |
| | | | ø40 | ø50 | ø63 | ø80 | ø100 |
| D-A9□ | 2 (Different surfaces, Same surface) 1 | 15 | 75 | — | 80 | 85 | 90 |
| | n | $15 + 40 \frac{(n-2)}{2}$ (n = 2, 4, 6, 8 ...) ^{Note 1} | $75 + 40 \frac{(n-4)}{2}$ (n = 4, 8, 12, 16 ...) ^{Note 2} | — | $80 + 40 \frac{(n-4)}{2}$ (n = 4, 8, 12, 16 ...) ^{Note 2} | $85 + 40 \frac{(n-4)}{2}$ (n = 4, 8, 12, 16 ...) ^{Note 2} | $90 + 40 \frac{(n-4)}{2}$ (n = 4, 8, 12, 16 ...) ^{Note 2} |
| D-A9□V | 2 (Different surfaces, Same surface) 1 | 10 | 50 | — | 55 | 60 | 65 |
| | n | $10 + 30 \frac{(n-2)}{2}$ (n = 2, 4, 6, 8 ...) ^{Note 1} | $50 + 30 \frac{(n-4)}{2}$ (n = 4, 8, 12, 16 ...) ^{Note 2} | — | $55 + 30 \frac{(n-4)}{2}$ (n = 4, 8, 12, 16 ...) ^{Note 2} | $60 + 30 \frac{(n-4)}{2}$ (n = 4, 8, 12, 16 ...) ^{Note 2} | $65 + 30 \frac{(n-4)}{2}$ (n = 4, 8, 12, 16 ...) ^{Note 2} |
| D-M9□ D-M9□W | 2 (Different surfaces, Same surface) 1 | 15 | 80 | 85 | 90 | 95 | |
| | n | $15 + 40 \frac{(n-2)}{2}$ (n = 2, 4, 6, 8 ...) ^{Note 1} | $80 + 40 \frac{(n-4)}{2}$ (n = 4, 8, 12, 16 ...) ^{Note 2} | $85 + 40 \frac{(n-4)}{2}$ (n = 4, 8, 12, 16 ...) ^{Note 2} | $90 + 40 \frac{(n-4)}{2}$ (n = 4, 8, 12, 16 ...) ^{Note 2} | $95 + 40 \frac{(n-4)}{2}$ (n = 4, 8, 12, 16 ...) ^{Note 2} | |
| D-M9□V D-M9□WV | 2 (Different surfaces, Same surface) 1 | 10 | 55 | 60 | 65 | 70 | |
| | n | $10 + 30 \frac{(n-2)}{2}$ (n = 2, 4, 6, 8 ...) ^{Note 1} | $55 + 30 \frac{(n-4)}{2}$ (n = 4, 8, 12, 16 ...) ^{Note 2} | $60 + 30 \frac{(n-4)}{2}$ (n = 4, 8, 12, 16 ...) ^{Note 2} | $65 + 30 \frac{(n-4)}{2}$ (n = 4, 8, 12, 16 ...) ^{Note 2} | $70 + 30 \frac{(n-4)}{2}$ (n = 4, 8, 12, 16 ...) ^{Note 2} | |
| D-M9□A | 2 (Different surfaces, Same surface) 1 | 15 | 80 | 85 | 95 | 100 | |
| | n | $15 + 40 \frac{(n-2)}{2}$ (n = 2, 4, 6, 8 ...) ^{Note 1} | $80 + 40 \frac{(n-4)}{2}$ (n = 4, 8, 12, 16 ...) ^{Note 2} | $85 + 40 \frac{(n-4)}{2}$ (n = 4, 8, 12, 16 ...) ^{Note 2} | $95 + 40 \frac{(n-4)}{2}$ (n = 4, 8, 12, 16 ...) ^{Note 2} | $100 + 40 \frac{(n-4)}{2}$ (n = 4, 8, 12, 16 ...) ^{Note 2} | |
| D-M9□AV | 2 (Different surfaces, Same surface) 1 | 10 | 60 | 65 | 70 | 75 | |
| | n | $10 + 30 \frac{(n-2)}{2}$ (n = 2, 4, 6, 8 ...) ^{Note 1} | $60 + 30 \frac{(n-4)}{2}$ (n = 4, 8, 12, 16 ...) ^{Note 2} | $65 + 30 \frac{(n-4)}{2}$ (n = 4, 8, 12, 16 ...) ^{Note 2} | $70 + 30 \frac{(n-4)}{2}$ (n = 4, 8, 12, 16 ...) ^{Note 2} | $75 + 30 \frac{(n-4)}{2}$ (n = 4, 8, 12, 16 ...) ^{Note 2} | |
| D-A5□/A6 D-F5□/J59 D-F5□W/J59W D-F5BA/F59F | 2 (Different surfaces, Same surface) 1 | 15 | 90 | 100 | 110 | 120 | |
| | n (Same surface) | $15 + 55 \frac{(n-2)}{2}$ (n = 2, 4, 6, 8 ...) ^{Note 1} | $90 + 55 \frac{(n-4)}{2}$ (n = 4, 8, 12, 16 ...) ^{Note 2} | $100 + 55 \frac{(n-4)}{2}$ (n = 4, 8, 12, 16 ...) ^{Note 2} | $110 + 55 \frac{(n-4)}{2}$ (n = 4, 8, 12, 16 ...) ^{Note 2} | $120 + 55 \frac{(n-4)}{2}$ (n = 4, 8, 12, 16 ...) ^{Note 2} | |
| D-A59W | 2 (Different surfaces, Same surface) | 20 | 90 | 100 | 110 | 120 | |
| | n (Same surface) | $20 + 55 \frac{(n-2)}{2}$ (n = 2, 4, 6, 8 ...) ^{Note 1} | $90 + 55 \frac{(n-4)}{2}$ (n = 4, 8, 12, 16 ...) ^{Note 2} | $100 + 55 \frac{(n-4)}{2}$ (n = 4, 8, 12, 16 ...) ^{Note 2} | $110 + 55 \frac{(n-4)}{2}$ (n = 4, 8, 12, 16 ...) ^{Note 2} | $120 + 55 \frac{(n-4)}{2}$ (n = 4, 8, 12, 16 ...) ^{Note 2} | |
| | 1 | 15 | 90 | 100 | 110 | 120 | |
| D-F5NT | 2 (Different surfaces, Same surface) 1 | 25 | 110 | 120 | 130 | 140 | |
| | n (Same surface) | $25 + 55 \frac{(n-2)}{2}$ (n = 2, 4, 6, 8 ...) ^{Note 1} | $110 + 55 \frac{(n-4)}{2}$ (n = 4, 8, 12, 16 ...) ^{Note 2} | $120 + 55 \frac{(n-4)}{2}$ (n = 4, 8, 12, 16 ...) ^{Note 2} | $130 + 55 \frac{(n-4)}{2}$ (n = 4, 8, 12, 16 ...) ^{Note 2} | $140 + 55 \frac{(n-4)}{2}$ (n = 4, 8, 12, 16 ...) ^{Note 2} | |
| D-B5□/B64 D-G5□/K59 D-G5□W D-K59W D-G5BA D-G59F D-G5NT | 2 (Different surfaces) | 15 | 90 | 100 | 110 | | |
| | (Same surface) | 75 | 90 | 100 | 110 | | |
| | (Different surfaces) | $15 + 50 \frac{(n-2)}{2}$ (n = 2, 4, 6, 8, ...) ^{Note 1} | $90 + 50 \frac{(n-4)}{2}$ (n = 4, 8, 12, 16, ...) ^{Note 2} | $100 + 50 \frac{(n-4)}{2}$ (n = 4, 8, 12, 16, ...) ^{Note 2} | $110 + 50 \frac{(n-4)}{2}$ (n = 4, 8, 12, 16, ...) ^{Note 2} | | |
| | n (Same surface) | $75 + 50(n-2)$ (n = 2, 3, 4, ...) | $90 + 50(n-2)$ (n = 2, 4, 6, 8, ...) ^{Note 1} | $100 + 50(n-2)$ (n = 2, 4, 6, 8, ...) ^{Note 1} | $110 + 50(n-2)$ (n = 2, 4, 6, 8, ...) ^{Note 1} | | |
| | 1 | 10 | 90 | 100 | 110 | | |
| D-B59W | 2 (Different surfaces) | 20 | 90 | 100 | 110 | | |
| | (Same surface) | 75 | 90 | 100 | 110 | | |
| | (Different surfaces) | $20 + 50 \frac{(n-2)}{2}$ (n = 2, 4, 6, 8, ...) ^{Note 1} | $90 + 50 \frac{(n-4)}{2}$ (n = 4, 8, 12, 16, ...) ^{Note 2} | $100 + 50 \frac{(n-4)}{2}$ (n = 4, 8, 12, 16, ...) ^{Note 2} | $110 + 50 \frac{(n-4)}{2}$ (n = 4, 8, 12, 16, ...) ^{Note 2} | | |
| | n (Same surface) | $75 + 50(n-2)$ (n = 2, 3, 4, ...) | $90 + 50(n-2)$ (n = 2, 4, 6, 8, ...) ^{Note 1} | $100 + 50(n-2)$ (n = 2, 4, 6, 8, ...) ^{Note 1} | $110 + 50(n-2)$ (n = 2, 4, 6, 8, ...) ^{Note 1} | | |
| | 1 | 15 | 90 | 100 | 110 | | |

Note 1) When "n" is an odd number, an even number that is one larger than this odd number is used for the calculation.

Note 2) When "n" is an odd number, a multiple of 4 that is larger than this odd number is used for the calculation.

Minimum Auto Switch Mounting Stroke

n: No. of auto switches (mm)

| Auto switch model | No. of auto switch mounted | Mounting brackets other than center trunnion | Center trunnion | | | | |
|--|--|--|--|---|---|---|---|
| | | | ø40 | ø50 | ø63 | ø80 | ø100 |
| D-A3□ D-G39 D-K39 | 2 | (Different surfaces) | 35 | 75 | 80 | 90 | |
| | | (Same surface) | 100 | 100 | 100 | 100 | |
| | n | (Different surfaces) | $35 + 30(n-2)$ (n = 2, 3, 4, ...) | $75 + 30(n-2)$ (n = 2, 4, 6, 8, ...) <small>Note 1</small> | $80 + 30(n-2)$ (n = 2, 4, 6, 8, ...) <small>Note 1</small> | $90 + 30(n-2)$ (n = 2, 4, 6, 8, ...) <small>Note 1</small> | |
| | | (Same surface) | $100 + 100(n-2)$ (n = 2, 3, 4, ...) | $100 + 100(n-2)$ (n = 2, 4, 6, 8, ...) <small>Note 1</small> | | | |
| | 1 | 10 | 75 | 80 | 90 | | |
| D-A44 | 2 | (Different surfaces) | 35 | 75 | 80 | 90 | |
| | | (Same surface) | 55 | | | | |
| | n | (Different surfaces) | $35 + 30(n-2)$ (n = 2, 3, 4, ...) | $75 + 30(n-2)$ (n = 2, 4, 6, 8, ...) <small>Note 1</small> | $80 + 30(n-2)$ (n = 2, 4, 6, 8, ...) <small>Note 1</small> | $90 + 30(n-2)$ (n = 2, 4, 6, 8, ...) <small>Note 1</small> | |
| | | (Same surface) | $55 + 50(n-2)$ (n = 2, 3, 4, ...) | $75 + 50(n-2)$ (n = 2, 4, 6, 8, ...) <small>Note 1</small> | $80 + 50(n-2)$ (n = 2, 4, 6, 8, ...) <small>Note 1</small> | $90 + 50(n-2)$ (n = 2, 4, 6, 8, ...) <small>Note 1</small> | |
| | 1 | 10 | 75 | 80 | 90 | | |
| D-A3□C D-G39C D-K39C | 2 | (Different surfaces) | 20 | 75 | 80 | 90 | |
| | | (Same surface) | 100 | 100 | 100 | 100 | |
| | n | (Different surfaces) | $20 + 35(n-2)$ (n = 2, 3, 4, ...) | $75 + 35(n-2)$ (n = 2, 4, 6, 8, ...) <small>Note 1</small> | $80 + 35(n-2)$ (n = 2, 4, 6, 8, ...) <small>Note 1</small> | $90 + 35(n-2)$ (n = 2, 4, 6, 8, ...) <small>Note 1</small> | |
| | | (Same surface) | $100 + 100(n-2)$ (n = 2, 3, 4, 5...) | $100 + 100(n-2)$ (n = 2, 4, 6, 8, ...) <small>Note 1</small> | | | |
| | 1 | 10 | 75 | 80 | 90 | | |
| D-A44C | 2 | (Different surfaces) | 20 | 75 | 80 | 90 | |
| | | (Same surface) | 55 | 75 | 80 | 90 | |
| | n | (Different surfaces) | $20 + 35(n-2)$ (n = 2, 3, 4, ...) | $75 + 35(n-2)$ (n = 2, 4, 6, 8, ...) <small>Note 1</small> | $80 + 35(n-2)$ (n = 2, 4, 6, 8, ...) <small>Note 1</small> | $90 + 35(n-2)$ (n = 2, 4, 6, 8, ...) <small>Note 1</small> | |
| | | (Same surface) | $55 + 50(n-2)$ (n = 2, 3, 4, ...) | $75 + 50(n-2)$ (n = 2, 4, 6, 8, ...) <small>Note 1</small> | $80 + 50(n-2)$ (n = 2, 4, 6, 8, ...) <small>Note 1</small> | $90 + 50(n-2)$ (n = 2, 4, 6, 8, ...) <small>Note 1</small> | |
| | 1 | 10 | 75 | 80 | 90 | | |
| D-Z7□/Z80 D-Y59□/Y7P D-Y7□W | 2 (Different surfaces, Same surface) 1 | 15 | 80 | 85 | 90 | 95 | 105 |
| | n | $15 + 40 \frac{(n-2)}{2}$ (n = 2, 4, 6, 8, ...) <small>Note 1</small> | $80 + 40 \frac{(n-4)}{2}$ (n = 4, 8, 12, 16, ...) <small>Note 2</small> | $85 + 40 \frac{(n-4)}{2}$ (n = 4, 8, 12, 16, ...) <small>Note 2</small> | $90 + 40 \frac{(n-4)}{2}$ (n = 4, 8, 12, 16, ...) <small>Note 2</small> | $95 + 40 \frac{(n-4)}{2}$ (n = 4, 8, 12, 16, ...) <small>Note 2</small> | $105 + 40 \frac{(n-4)}{2}$ (n = 4, 8, 12, 16, ...) <small>Note 2</small> |
| D-Y69□/Y7PV D-Y7□WV | 2 (Different surfaces, Same surface) 1 | 10 | 65 | 75 | 80 | 90 | |
| | n | $10 + 30 \frac{(n-2)}{2}$ (n = 2, 4, 6, 8, ...) <small>Note 1</small> | $65 + 30 \frac{(n-4)}{2}$ (n = 4, 8, 12, 16, ...) <small>Note 2</small> | $75 + 30 \frac{(n-4)}{2}$ (n = 4, 8, 12, 16, ...) <small>Note 2</small> | $80 + 30 \frac{(n-4)}{2}$ (n = 4, 8, 12, 16, ...) <small>Note 2</small> | $90 + 30 \frac{(n-4)}{2}$ (n = 4, 8, 12, 16, ...) <small>Note 2</small> | |
| D-Y7BA | 2 (Different surfaces, Same surface) 1 | 20 | 95 | 100 | 105 | 110 | |
| | n | $20 + 45 \frac{(n-2)}{2}$ (n = 2, 4, 6, 8, ...) <small>Note 1</small> | $95 + 45 \frac{(n-4)}{2}$ (n = 4, 8, 12, 16, ...) <small>Note 2</small> | $100 + 45 \frac{(n-4)}{2}$ (n = 4, 8, 12, 16, ...) <small>Note 2</small> | $105 + 45 \frac{(n-4)}{2}$ (n = 4, 8, 12, 16, ...) <small>Note 2</small> | $110 + 45 \frac{(n-4)}{2}$ (n = 4, 8, 12, 16, ...) <small>Note 2</small> | |

Note 1) When "n" is an odd number, an even number that is one larger than this odd number is used for the calculation.

Note 2) When "n" is an odd number, a multiple of 4 that is larger than this odd number is used for the calculation.

Operating Range

| Auto switch model | Bore size (mm) | | | | |
|--|----------------|----|-----|-----|------|
| | 40 | 50 | 63 | 80 | 100 |
| D-A9□/A9□V | 7 | — | 9 | 9 | 9 |
| D-M9□/M9□V D-M9□W/M9□WV D-M9□A/M9□AV | 5 | 5 | 5.5 | 6 | 6.5 |
| D-Z7□/Z80 | 8 | 7 | 9 | 9.5 | 10.5 |
| D-A3□/A44 D-A3□C/A44C | 9 | 10 | 11 | 11 | 11 |
| D-A5□/A6□ | | | | | |
| D-B5□/B64 | | | | | |
| D-A59W | 13 | 13 | 14 | 14 | 15 |
| D-B59W | 14 | 14 | 17 | 16 | 18 |

| Auto switch model | Bore size (mm) | | | | |
|---|----------------|----|-----|-----|-----|
| | 40 | 50 | 63 | 80 | 100 |
| D-Y59□/Y69□ D-Y7P/Y7□V D-Y7□W/Y7□WV D-Y7BA | 8 | 7 | 5.5 | 6.5 | 6.5 |
| D-F5□/J59/F5□W D-J59W/F5BA D-F5NT D-F59F | 4 | 4 | 4.5 | 4.5 | 4.5 |
| D-G5□/K59/G5□W D-K59W/G5BA D-G5NT/G59F | 5 | 6 | 6.5 | 6.5 | 7 |
| D-G39/K39 D-G39C/K39C | 9 | 9 | 10 | 10 | 11 |

* D-A9□ and D-A9□V cannot be mounted on ø50.

* Since the operating range is provided as a guideline including hysteresis, it cannot be guaranteed (assuming approximately ±30% dispersion). It may vary substantially depending on an ambient environment.

Auto Switch Mounting Bracket: Part No.

<Tie-rod mounting>

| Auto switch model | Bore size (mm) | | | | |
|---|----------------|---------|---------|---------|---------|
| | 40 | 50 | 63 | 80 | 100 |
| D-A9□/A9□V D-M9□/M9□V D-M9□W/M9□WV D-M9□A/M9□AV | BA7-040 | BA7-040 | BA7-063 | BA7-080 | BA7-080 |
| D-A5□/A6□ D-A59W D-F5□/J59 D-F5□W/J59W D-F59F/F5NT | BT-04 | BT-04 | BT-06 | BT-08 | BT-08 |
| D-A3□C/A44C D-G39C/K39C | BA3-040 | BA3-050 | BA3-063 | BA3-080 | BA3-100 |
| D-Z7□/Z80 D-Y59□/Y69□ D-Y7P/Y7P D-Y7□W/Y7□WV D-Y7BA | BA4-040 | BA4-040 | BA4-063 | BA4-080 | BA4-080 |

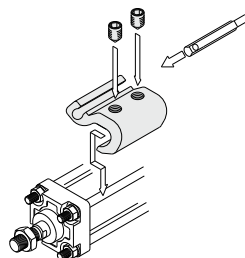

• Mounting example of D-A9□(V)/M9□(V)/M9□W(V)/M9□A(V)

<Band mounting>

| Auto switch model | Bore size (mm) | | | | |
|---|----------------|---------|---------|---------|---------|
| | 40 | 50 | 63 | 80 | 100 |
| D-A3□/A44 D-G39/K39 | BD1-04M | BD1-05M | BD1-06M | BD1-08M | BD1-10M |
| D-B5□/B64 D-B59W D-G5□/K59 D-G5□W/K59W D-G59F D-G5NT | BA-04 | BA-05 | BA-06 | BA-08 | BA-10 |

Note 1) D-A9□ and D-A9□V cannot be mounted on ø50.

Note 2) Auto switch mounting brackets are included in D-A3□C/A44C/G39C/K39C.

Order them in accordance with the cylinder size as shown below.

(Example) ø40: D-A3□C-4, ø50: D-A3□C-5

ø63: D-A3□C-6, ø80: D-A3□C-8, ø100: D-A3□C-10

Order them with the part numbers above when the mounting brackets are required separately.

[Mounting screw set made of stainless steel]

The following set of mounting screws made of stainless steel (including nuts) is available. Use it in accordance with the operating environment.

(Please order the auto switch mounting bracket and band separately, since they are not included.)

BBA1: For D-A5/A6/F5/J5 types

BBA3: For D-B5/B6/G5/K5 types

D-F5BA/G5BA auto switches are set on the cylinder with the stainless steel screws above when shipped. When an auto switch is shipped independently, BBA1 or BBA3 is attached.

Note 3) Refer to pages 1439 and 1447 for the details of BBA1 and BBA3.

Note 4) When using M9□A(V)/Y7BA, do not use the steel set screws which is included with the auto switch mounting brackets above (BA7-□□□, BA4-□□□).

Order a stainless steel screw set (BBA1) separately, and select and use the M4 x 6L stainless steel set screws included in the BBA1.

Besides the models listed in How to Order, the following auto switches are applicable.
Refer to pages 1341 to 1435 for detailed specifications.

| Auto switch type | Part no. | Electrical entry (Fetching direction) | Features |
|--------------------|---------------------------|---------------------------------------|--|
| Reed | D-A93V, A96V | Grommet (Perpendicular) | — |
| | D-A90V | | Without indicator light |
| | D-A53, A56, B53, Z73, Z76 | Grommet (In-line) | — |
| | D-A67, Z80 | | Without indicator light |
| Solid state | D-M9NV, M9PV, M9BV | Grommet (Perpendicular) | — |
| | D-Y69A, Y69B, Y7PV | | Diagnostic indication (2-color indicator) |
| | D-M9NWW, M9PWW, M9BWW | | |
| | D-Y7NWW, Y7PWW, Y7BWW | Grommet (In-line) | Water resistant (2-color indicator) |
| | D-M9NAV, M9PAV, M9BAV | | — |
| | D-Y59A, Y59B, Y7P | | Diagnostic indication (2-color indicator) |
| | D-F59, F5P, J59 | | |
| | D-Y7NWW, Y7PW, Y7BW | | Water resistant (2-color indicator) |
| | D-F59W, F5PW, J59W | | |
| | D-F5BA, Y7BA | | |
| | D-F5NT, G5NT | | |

* For solid state auto switches, auto switches with a pre-wired connector are also available. Refer to pages 1410 and 1411 for details.

* Normally closed (NC = b contact) solid state auto switches (D-M9□E(V)/Y7G/Y7H) are also available. Refer to pages 1360 and 1362 for details.



CE2 Series

Specific Product Precautions

Be sure to read this before handling the products.

Refer to page 9 for safety instructions and pages 10 to 19 for actuator and auto switch precautions.

Sensor

⚠ Caution

Because a magnetic system is adopted in the sensor unit of the stroke reading cylinder with brake, the presence of a strong magnetic fields in the vicinity of the sensor could lead to a malfunction.

Operate the system with an external magnetic field of 14.5 mT.

This is equivalent to a magnetic field of approximately 18 cm in radius from a welding area using a welding amperage of almost 15,000 amperes. To use the system in a magnetic field that exceeds this value, use a magnetic material to shield the sensor unit.

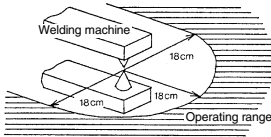

The sensor unit is adjusted to an appropriate position at the time of shipment. Therefore, never detach the sensor unit from the body. Make sure that water does not splash on the sensor unit (enclosure IP65). Do not pull on the sensor cable.

Noise

Operating the stroke reading cylinder with brake in the vicinity of equipment that generates noise, such as a motor or a welder, could result in miscounting. Therefore, minimize the generation of noise as much as possible, and keep the wiring separate.

Also, the maximum transmission distance of the stroke reading cylinder with brake is 20.5 m. Make sure that the wiring does not exceed this distance. Besides, when the transmission distance is over 20.5 m, use the dedicated transmission box (Part no. CE1-H0374).

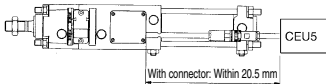

How to Manually Disengage the Lock and Change from the Unlocked to the Locked State

Manual unlocking

1. Loosen the two hexagon socket head cap bolts and remove the pin guide.
2. As viewed from the end of the rod, the pin is tilted 15° to the left of the center.
3. Supply an air pressure of 0.3 MPa or more to the unlocking port.
4. Rotate the pin 30° to the right with a wooden implement such as the grip of a wooden hammer or a resin stick without scratching.

How to manually change from an unlocked state to a locked state

1. Loosen the two hexagon socket head cap bolts and remove the pin guide.
2. As viewed from the end of the rod, the pin is tilted 15° to the right of the center.
3. Supply air pressure of 0.3 MPa to the unlocking port.
4. Rotate the pin 30° by pushing it with a wooden implement such as the grip of a wooden hammer or a resin stick.

(Note) Never rotate the pin by striking it since this may bend or damage the pin. Be careful when pushing the pin since the surface is slippery.

5. Inside the pin guide, there is a slotted hole that is slightly larger than the pin. Align the pin with the slotted hole and secure them to cover, using the hexagon socket head cap screws that were removed in step 1. The convex of the pin guide and "LOCK" on the locking condition indication plate will align.

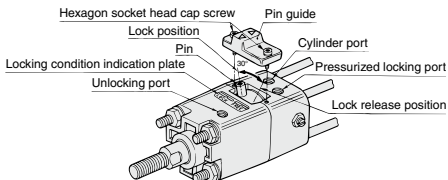

Caution on Handling

⚠ Caution

1. Operate the cylinder in such a way that the load is always applied in the axial direction.

In case the load is applied in a direction other than the axial direction of the cylinder, provide a guide to constrain the load itself. In such a case, take precautions to prevent off-centering. If the piston rod and the load are off-centered, the speed of the movement of the piston could fluctuate, which could affect the piston's stopping accuracy and shorten the life of the brake unit.

2. If there is a large amount of dust in the operating environment, use a cylinder with a bellows to prevent the intrusion of dust. Also, be aware that the operating temperature range is between 0 and 60°C.

3. The brake unit and the cylinder rod cover area are assembled as shown in the diagram below. For this reason, unlike ordinary cylinders, it is not possible to use the standard type mounted directly onto a machine by screwing in the cylinder tie-rods.

Furthermore, when replacing mounting brackets, the unit holding tie-rods may get loosen. Tighten them once again in such a case.

Use a socket wrench when replacing mounting brackets or retightening the unit holding tie-rods.

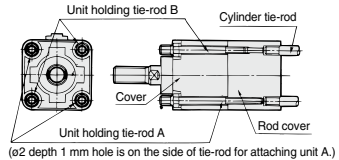

| Bore size (mm) | Mounting bracket nut | | Unit holding tie-rod | |
|----------------|----------------------------------|--------|---------------------------------------|---|
| | Nut | Socket | Width across flats | Socket |
| 40 | JIS B 1181 Class 3 M8 x 1.25 | 13 | JIS B 4636 2 point angle socket 13 | 10 JIS B 4636 2 point angle socket 10 |
| 50 | JIS B 1181 Class 3 M10 x 1.25 | 17 | JIS B 4636 2 point angle socket 17 | 13 JIS B 4636 2 point angle socket 13 |
| 63 | JIS B 1181 Class 3 M10 x 1.25 | 17 | JIS B 4636 2 point angle socket 17 | 13 JIS B 4636 2 point angle socket 13 |
| 80 | JIS B 1181 Class 3 M12 x 1.75 | 19 | JIS B 4636 2 point angle socket 19 | 17 JIS B 4636 2 point angle socket 17 |

Operating Cautions

Counting speed of the counter

Be aware that if the speed of the stroke reading cylinder with brake is faster than the counting speed of the counter, the counter will miscount.

Use CEU5.

Cylinder speed < Counting speed of the counter
(Cylinder speed 500 mm/sec = Counting speed of the counter 5 kcps)

Miscounting by lurching or bounding

If the stroke reading cylinder with brake lurches or bounds during an IN or OUT movement, or due to other factors, be aware that the cylinder speed could increase momentarily, possibly exceeding the counter's counting speed or the sensor's response speed, which could lead to miscounting.