

Miniature Body

- Full length is shortened by up to approx. **20%**.
- Volume is reduced by up to approx. **45%**.

(Compared with the CQS series cylinders, double acting, with magnet)

Dimensions (With Magnet) (mm)

Bore size (mm)	A(a)	B(b)	C(c)
12	17(25)	26.5(25)	19.5(22)
16	21(29)	29.5(29)	21(22)
20	25(36)	36(36)	23.5(29.5)

() : Dimensions of the CQS series cylinders

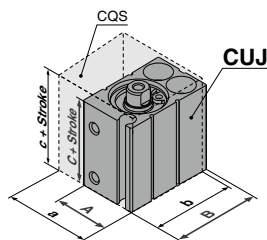

- Full length is shortened by up to approx. **64%**.
- Volume is reduced by up to approx. **70%**.

(Compared with the CU series cylinders, double acting, without magnet)

Dimensions (Without Magnet) (mm)

Bore size (mm)	A(a)	B(b)	C(c)
4	10(—)	15(—)	13(—)
6	13(13)	19(22)	13(33)
8	13(—)	21(—)	13(—)
10	13.5(15)	22(24)	13(36)
12	17(—)	26.5(—)	15.5(—)
16	21(20)	29.5(32)	16.5(30)
20	25(26)	36(40)	19.5(36)

() : Dimensions of the CU series cylinders

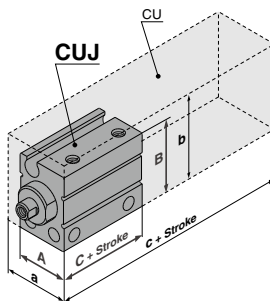

Ø4, Ø6, Ø8, Ø10

Concentrates wiring and piping on one side

Allows more efficient installation, since four directions can be used freely.

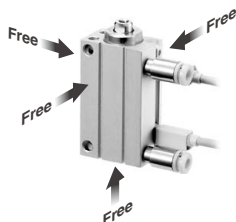

Allows installation from four directions.

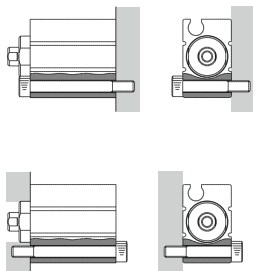

Ø12, Ø16, Ø20

With counterbore for mounting

2 kinds of bodies are available. There is no protrusion for a mounting bolt.

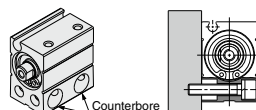

Lateral mounting body/ CUJB

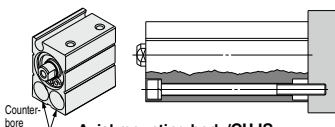

Axial mounting body/ CUJS

CUJ Series $\varnothing 4, \varnothing 6, \varnothing 8, \varnothing 10, \varnothing 12, \varnothing 16, \varnothing 20$

Two auto switches can be installed even for a 4 mm stroke.*

* $\varnothing 12$ to $\varnothing 20$ are available starting from a 5 mm stroke.

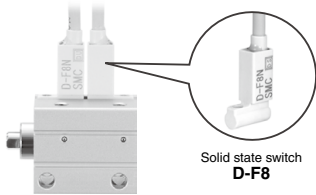

Solid state switch
D-F8

Easy seal replacement

Seals can be replaced easily by just removing the rod cover ($\varnothing 4$ to $\varnothing 10$) or retaining ring ($\varnothing 12$ to $\varnothing 20$).

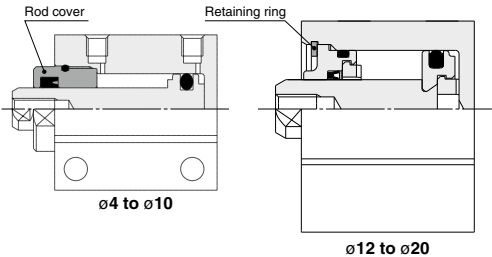

$\varnothing 4$ to $\varnothing 10$

$\varnothing 12$ to $\varnothing 20$

$\varnothing 4, \varnothing 6, \varnothing 8, \varnothing 10$

With boss (h9)

Centering can be done easily.

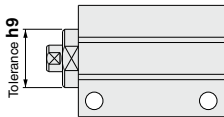

Clean room compliant Clean Series (except $\varnothing 4$)

CUJ Series 10-11-

(Refer to pages 703 and 712.)

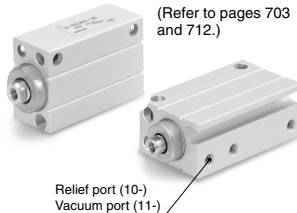

Relief port (10-)
Vacuum port (11-)

$\varnothing 12, \varnothing 16, \varnothing 20$

Standard equipment with damper

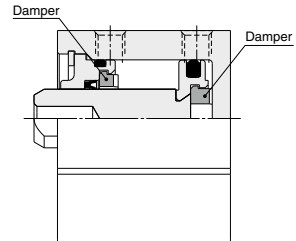

Damper

Damper

RoHS compliant

Applications

Short pitch mounting is possible.

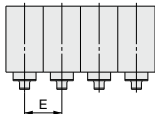

Pitch Dimensions
(Without Magnet) (mm)

Bore size	E
4	10 Note 1)
6	13 Note 1)
8	13 Note 1)
10	13.5 Note 1)
12	17
16	21
20	25

Note 1) Body width dimensions have plus tolerances, so E dimensions should also be designed for plus tolerances. ($\varnothing 4$ to $\varnothing 10$ only)

Note 2) Refer to page 717 for built-in magnet.

Lowering the center of gravity when using an external guide

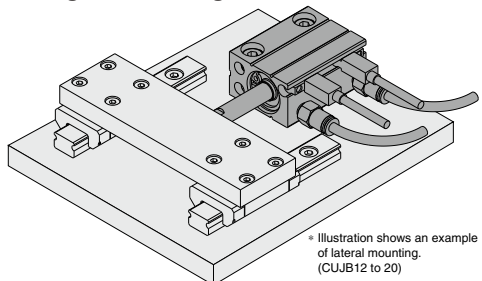

* Illustration shows an example of lateral mounting. (CUJB12 to 20)

Mini Free Mount Cylinder

CUJ Series

ø4, ø6, ø8, ø10



How to Order

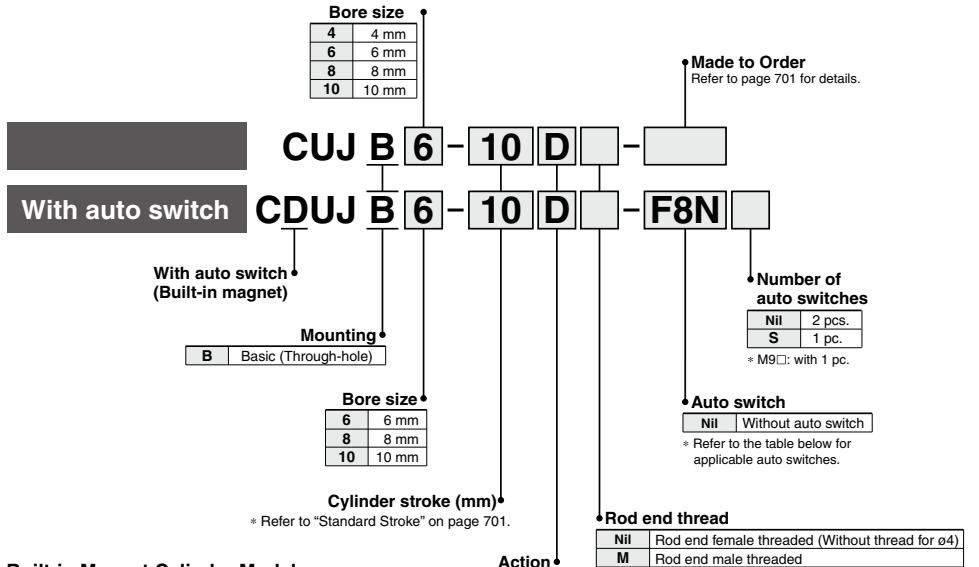

Built-in Magnet Cylinder Model

In the case of built-in magnet without auto switch, the symbol for auto switch is "Nil".
(Example) CDUJB8-15DM

Applicable Auto Switches

Refer to pages 1271 through to 1365 for additional information on auto switches.

Type	Special function	Electrical entry	Indicator light	Wiring (Output)	Load voltage		Auto switch model		Lead wire length (m) *			Pre-wired connector	Applicable load		
					DC	AC	Perpendicular	In-line	0.5 (Nil)	1 (M)	3 (L)		5 (Z)	IC circuit	Relay, PLC
									—	●	●		○		
Solid state auto switch	—	Grommet	Yes	3-wire (NPN)	5 V, 12 V	—	M9N	●	●	●	○	○	IC circuit	Relay, PLC	
				3-wire (PNP)			F8N	—	—	—	—	—			
				2-wire	M9P		●	●	●	○	○				
				3-wire (NPN)	F8P		●	—	●	○	—				
				3-wire (PNP)	M9B		●	●	●	○	○				
				2-wire	F8B		—	—	—	—	—				
	Diagnostic indication (2-color indicator)	Grommet	Yes	Yes	3-wire (NPN)	5 V, 12 V	—	M9NW	●	●	●	○	○	IC circuit	Relay, PLC
					3-wire (PNP)			M9PW	●	●	●	○	○		
					2-wire	M9BW		●	●	●	○	○			
					3-wire (NPN)	M9NA**		○	○	●	○	○			
					3-wire (PNP)	M9PA**		○	○	●	○	○			
					2-wire	M9BA**		○	○	●	○	○			

** Water resistant type auto switches can be mounted on the above models, but in such case SMC cannot guarantee water resistance. Consult with SMC regarding water resistant types with the above model numbers.

* Lead wire length symbols: 0.5 m Nil (Example) M9N
1 m M (Example) M9NM
3 m L (Example) M9NL
5 m Z (Example) M9NZ

* Auto switches marked with "○" are produced upon receipt of order.

Note 1) For 2-color indicator, use caution on hysteresis. Refer to page 1281, "Auto Switch Hysteresis" prior to use.

Note 2) Refer to pages 1271 through to 1365 for detailed auto switch specifications.

* Auto switches are included, (but not assembled).

Specifications



Bore size (mm)		4	6	8	10
Action		Double acting; Single acting, spring return			
Fluid		Air			
Proof pressure		1.05 MPa			
Minimum operating pressure	Double acting	0.15 MPa			0.1 MPa
	Single acting, spring return	0.35 MPa	0.3 MPa		0.2 MPa
Maximum operating pressure		0.7 MPa			
Ambient and fluid temperature		Without auto switch: -10 to 70°C (No freezing) With auto switch: -10 to 60°C (No freezing)			
Cushion		None			
Lubrication		Non-lube			
Piston speed		50 to 500 mm/s			
Stroke length tolerance		+0.5			
Mounting		Through-hole			

Theoretical Output: Double Acting

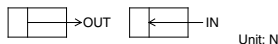

Bore size (mm)	Rod size (mm)	Operating direction	Piston area (mm ²)	Operating pressure (MPa)		
				0.3	0.5	0.7
4	2	OUT	12.6	3.76	6.28	8.79
		IN	9.4	2.82	4.71	6.59
6	4	OUT	28.3	8.48	14.13	19.79
		IN	15.7	4.71	7.85	10.99
8	5	OUT	50.3	15.07	25.13	35.18
		IN	30.6	9.18	15.31	21.44
10	6	OUT	78.5	23.56	39.26	54.97
		IN	50.3	15.07	25.13	35.18

Symbol

Double acting, single rod, without cushion

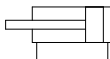

Single acting, spring return

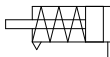

Standard Stroke

Action	Bore size (mm)	Standard stroke (mm)
Double acting	4	4, 6, 8, 10, 15, 20
	6	4, 6, 8, 10, 15, 20
	8, 10	25, 30
Single acting, spring return	4	4, 6
	6	4, 6, 8
	8, 10	4, 6, 8, 10

Spring Reaction Force: Single Acting, Spring Return

Spring in pre-loaded condition



When the spring is set in the cylinder.

Spring in loaded condition



When the spring is contracted by applying air.

Bore size (mm)	Spring condition	Stroke (mm)			
		4	6	8	10
4	Pre-loaded	1.70	1.27	—	—
	Loaded	2.55	2.55	—	—
6	Pre-loaded	2.45	2.01	1.57	—
	Loaded	3.33	3.33	3.33	—
8	Pre-loaded	4.67	3.76	2.86	1.96
	Loaded	6.47	6.47	6.47	6.47
10	Pre-loaded	5.04	4.18	3.31	2.45
	Loaded	6.77	6.77	6.77	6.77



Made to Order
Click here for details

Symbol	Contents
-XA□	Change of Rod End Shape <small>Note 1)</small>
-XB6	Heat resistant cylinder (-10 to 150°C) <small>Note 1)</small>
-XC22	Fluororubber seals <small>Note 2)</small>

Note1) Except models with auto switch and single-acting, spring return type
Except bore size 4

Note2) Except single acting, spring return type and bore size 4

Moisture Control Tube IDK Series



When operating an actuator with a small diameter and a short stroke at a high frequency, the dew condensation (water droplet) may occur inside the piping depending on the conditions.

Simply connecting the moisture control tube to the actuator will prevent dew condensation from occurring. For details, refer to the [Web Catalog](#).

Weight: Double Acting

Bore size (mm)	Standard stroke (mm)							Additional weight		
	4	6	8	10	15	20	25	30	Built-in magnet	Rod end male threaded
CUJB4	7.2	7.9	8.6	9.3	11.1	12.8	—	—	—	0.4
CUJB6	12.4	13.6	14.8	16.0	18.9	21.8	24.7	27.6	2.7	0.8
CUJB8	15.6	17.0	18.4	19.7	23.0	26.4	29.9	33.4	3.0	1.5
CUJB10	17.9	19.4	20.8	22.3	25.9	29.5	33.1	36.7	3.2	2.6

Weight: Single Acting, Spring Return

Bore size (mm)	Standard stroke (mm)				Additional weight	
	4	6	8	10	Built-in magnet	Rod end male threaded
CUJB4	7.2	7.9	—	—	—	0.4
CUJB6	12.8	14.0	15.2	—	2.4	0.8
CUJB8	15.8	17.2	18.6	19.9	2.5	1.5
CUJB10	17.9	19.4	20.8	22.3	2.4	2.6

CUJ Series

Mounting

How to Mount: Through-hole mounting bolts are available.

How to Order: Add the "CUJ-" in front of the bolts to be used.

Example) CUJ-M3 x 27 L

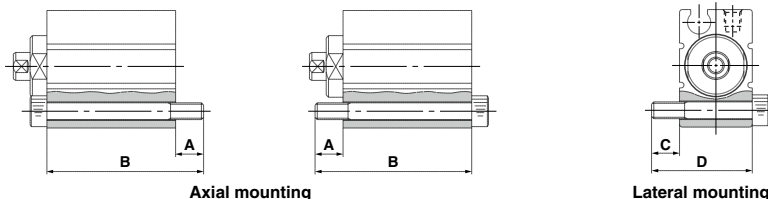

Without Auto Switch (Without Magnet)

For Axial Mounting

Cylinder model	A	B	Mounting bolt size
CUJB4-4	4	21	M2.5 x 21 L
-6		23	M2.5 x 23 L
-8		25	M2.5 x 25 L
-10		27	M2.5 x 27 L
-15		32	M2.5 x 32 L
-20		37	M2.5 x 37 L <small>Note</small>
CUJB6-4	5	22	M3 x 22 L
-6		24	M3 x 24 L
-8		26	M3 x 26 L
-10		28	M3 x 28 L
-15		33	M3 x 33 L
-20		38	M3 x 38 L
-25	43	M3 x 43 L	
-30	48	M3 x 48 L	
CUJB8-4	5	22	M3 x 22 L
-6		24	M3 x 24 L
-8		26	M3 x 26 L
-10		28	M3 x 28 L
-15		33	M3 x 33 L
-20		38	M3 x 38 L
-25	43	M3 x 43 L	
-30	48	M3 x 48 L	
CUJB10-4	5	22	M3 x 22 L
-6		24	M3 x 24 L
-8		26	M3 x 26 L
-10		28	M3 x 28 L
-15		33	M3 x 33 L
-20		38	M3 x 38 L
-25	43	M3 x 43 L	
-30	48	M3 x 48 L	

Note) Only M2.5 x 37 L is made of stainless steel. Others are made of structural steel.

For Lateral Mounting

Cylinder model	C	D	Mounting bolt size
CUJB4-4	4	14	M2.5 x 14 L
-6			
-8			
-10			
-15			
-20			
CUJB6-4	5	18	M3 x 18 L
-6			
-8			
-10			
-15			
-20			
-25			
-30			
CUJB8-4	5	18	M3 x 18 L
-6			
-8			
-10			
-15			
-20			
-25			
-30			
CUJB10-4	5	18	M3 x 18 L
-6			
-8			
-10			
-15			
-20			
-25			
-30			

With Auto Switch (Built-in Magnet)

For Axial Mounting

Cylinder model	A	B	Mounting bolt size
CDUJB6-4	5	27	M3 x 27 L
-6		29	M3 x 29 L
-8		31	M3 x 31 L
-10		33	M3 x 33 L
-15		38	M3 x 38 L
-20		43	M3 x 43 L
-25	48	M3 x 48 L	
-30	53	M3 x 53 L	
CDUJB8-4	5	27	M3 x 27 L
-6		29	M3 x 29 L
-8		31	M3 x 31 L
-10		33	M3 x 33 L
-15		38	M3 x 38 L
-20		43	M3 x 43 L
-25	48	M3 x 48 L	
-30	53	M3 x 53 L	
CDUJB10-4	5	27	M3 x 27 L
-6		29	M3 x 29 L
-8		31	M3 x 31 L
-10		33	M3 x 33 L
-15		38	M3 x 38 L
-20		43	M3 x 43 L
-25	48	M3 x 48 L	
-30	53	M3 x 53 L	

For Lateral Mounting

Cylinder model	C	D	Mounting bolt size
CDUJB6-4	5	18	M3 x 18 L
-6			
-8			
-10			
-15			
-20			
-25			
-30			
CDUJB8-4	5	18	M3 x 18 L
-6			
-8			
-10			
-15			
-20			
-25			
-30			
CDUJB10-4	5	18	M3 x 18 L
-6			
-8			
-10			
-15			
-20			
-25			
-30			

■ Clean Series

How to Order

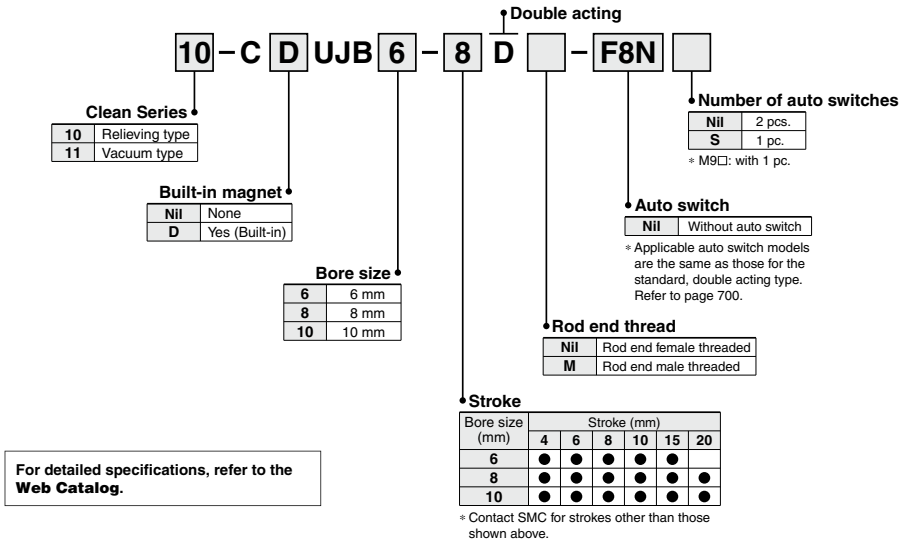

Specifications

The specifications are the same as those for the standard, double acting type. Refer to page 701. However, the operating piston speed is ranged from 50 to 400 mm/s.

Dimensions

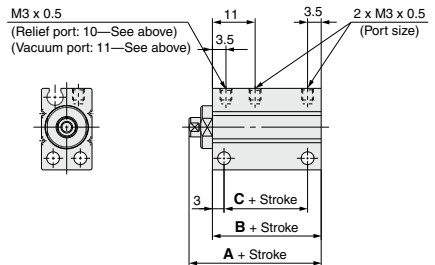

Bore size (mm)	Without auto switch			With auto switch		
	A	B	C	A	B	C
6, 8, 10	24	18	11.5	29	23	16.5

(mm)



Construction

Double Acting

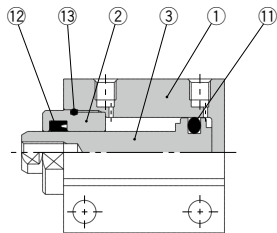

Without magnet

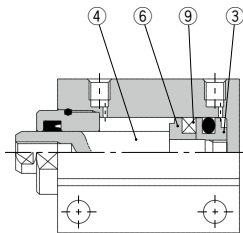

Built-in magnet

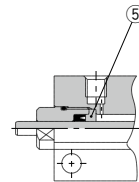

ø4

Single Acting, Spring Return

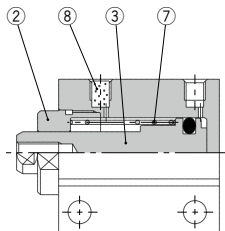

Without magnet

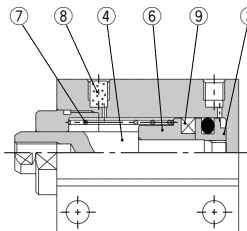

Built-in magnet

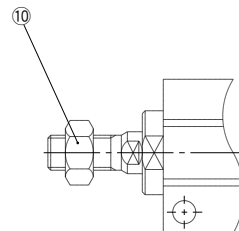

Rod end male threaded

Component Parts

No.	Description	Material	Note
1	Cylinder tube	Aluminum alloy	Hard anodized
2	Rod cover	Copper alloy	Electroless nickel plated
3	Piston	Stainless steel	
	Without switch	Aluminum alloy	Chromated
4	Piston rod	Stainless steel	
5	Seal retainer	Aluminum alloy	Chromated (CUJB4 only)
6	Magnet retainer	Aluminum alloy	Chromated
7	Return spring	Piano wire	
8	Bronze element	Sintered metallic BC	
9	Magnet	—	
10	Rod end nut	Iron	Chromated
11	Piston seal	NBR	
12	Rod seal	NBR	
13	Tube gasket	NBR	

Replacement Parts: Seal Kit Double Acting

Bore size (mm)	Kit no.	Contents
4	CUJB4-PS	Set of 11, 12, 13 and grease pack.
6	CUJB6-PS	
8	CUJB8-PS	
10	CUJB10-PS	

* Seal kit 11 to 13 comes as a set. Use the kit number for each bore size.

Single Acting, Spring Return

Bore size (mm)	Kit no.	Contents
4	CUJB4-S-PS	Set of 11 and grease pack.
6	CUJB6-S-PS	
8	CUJB8-S-PS	
10	CUJB10-S-PS	

* Use the following part number for ordering a grease pack only.
Grease part no.: GR-L-005 (5 g)

Dimensions: $\phi 4$ Double Acting; Single Acting, Spring Return

Without Magnet: CUJB4

Note) The position of the width across flats may not be parallel to the cylinder tube.

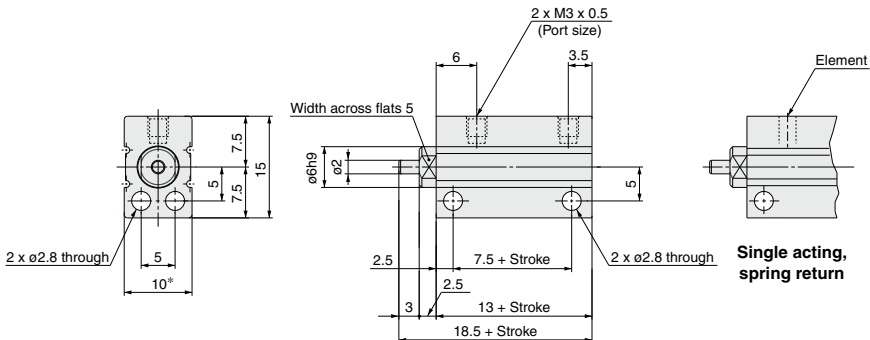

Rod end male threaded

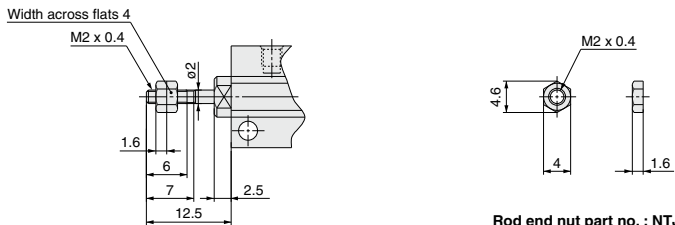

* Use caution especially when multiple cylinders are used in parallel such as stacking because the body width dimensions have plus tolerances.
Contact SMC for a product with body width dimensions having different tolerances.

CUJ Series

Dimensions: $\phi 6$ Double Acting; Single Acting, Spring Return

Without Magnet: CUJB6

Note) The position of the width across flats may not be parallel to the cylinder tube.

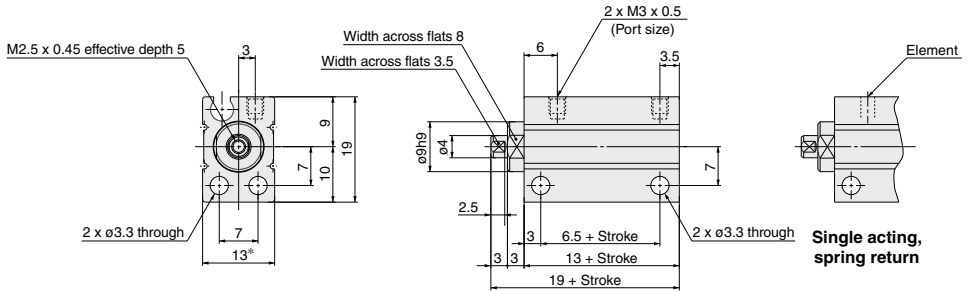

Built-in Magnet: CDUJB6

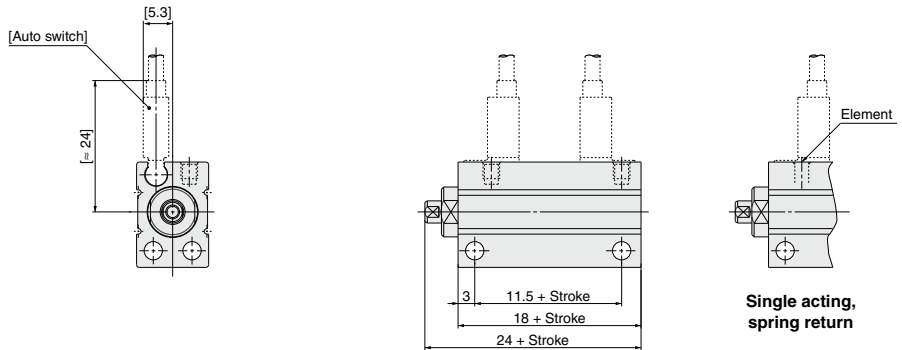

Rod end male threaded

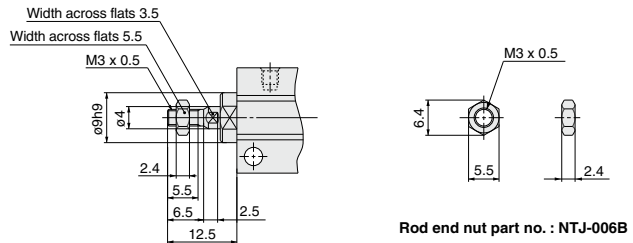

* Use caution especially when multiple cylinders are used in parallel such as stacking because the body width dimensions have plus tolerances.
Contact SMC for a product with body width dimensions having different tolerances.

CUJ Series

Dimensions: $\phi 10$ Double Acting; Single Acting, Spring Return

Without Magnet: CUJB10

Note) The position of the width across flats may not be parallel to the cylinder tube.

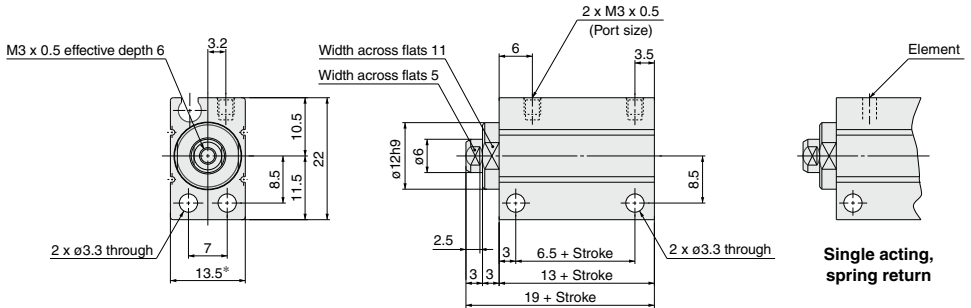

Built-in Magnet: CDUJB10

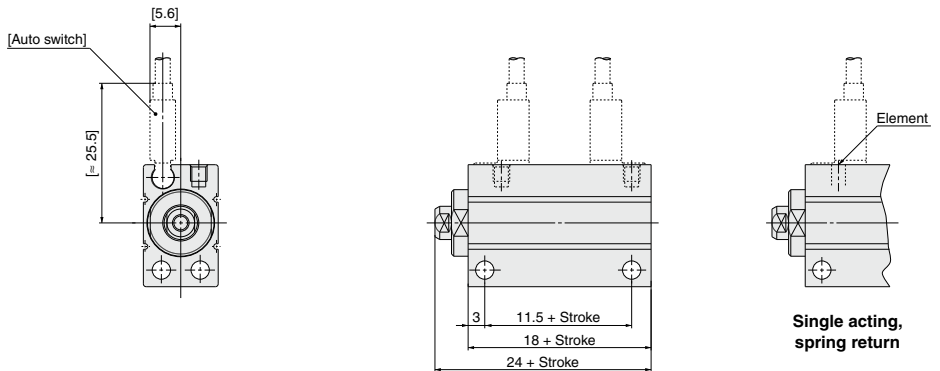

Rod end male threaded

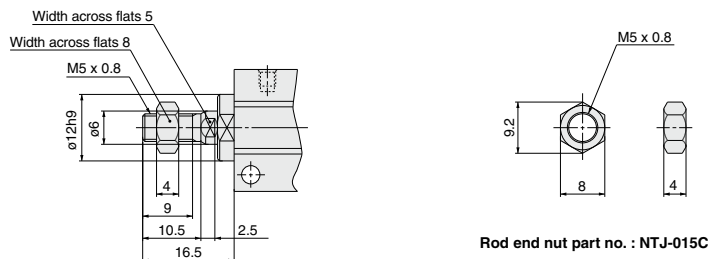

Rod end nut part no. : NTJ-015C

* Use caution especially when multiple cylinders are used in parallel such as stacking because the body width dimensions have plus tolerances. Contact SMC for a product with body width dimensions having different tolerances.

Mini Free Mount Cylinder

CUJ Series

ø12, ø16, ø20



How to Order

CUJ B 12 - 30 D - [] - []

With auto switch **CDUJ B 12 - 30 D** - [] - **F8N** - [] - []

With auto switch (Built-in magnet)

Mounting direction

B Lateral mounting

S Axial mounting

Made to Order
Refer to page 710 for details.

Auto switch

Nil	2 pcs.
S	1 pc.

* M9□: with 1 pc.

Auto switch

Nil	Without auto switch
-----	---------------------

* Refer to the table below for applicable auto switches.

Rod end thread

Nil	Rod end female threaded
M	Rod end male threaded

Action

D	Double acting
S	Single acting, spring return
T	Single acting, spring extend

Bore size

12	12 mm
16	16 mm
20	20 mm

Cylinder stroke (mm)
* Refer to "Standard Stroke" on page 710.

Built-in Magnet Cylinder Model

In the case of built-in magnet without auto switch, the symbol for auto switch is "Nil".
(Example) CDUJB12-15DM

Applicable Auto Switches

Refer to pages 1271 through to 1365 for additional information on auto switches.

Type	Special function	Electrical entry	Indicator light	Wiring (Output)	Load voltage		Auto switch model		Lead wire length (m) *			Pre-wired connector	Applicable load			
					DC	AC	Perpendicular	In-line	0.5 (Nil)	1 (M)	3 (L)			5 (Z)		
Solid state auto switch	—	Grommet	Yes	3-wire (NPN)	5 V, 12 V	—	—	M9N	●	●	●	○	○	IC circuit		
				3-wire (PNP)			F8N	—	—	—	—	—	—		—	
				2-wire	12 V		—	M9P	●	●	●	○	○		—	
				3-wire (NPN)	24 V		5 V, 12 V	F8P	—	—	—	—	—		—	
				3-wire (PNP)			12 V	—	M9B	●	●	●	○		○	—
				2-wire	5 V, 12 V		F8B	—	—	—	—	—	—		—	
	Diagnostic indication (2-color indicator)	Grommet	Yes	3-wire (NPN)	5 V, 12 V		—	M9NW	●	●	●	○	○	○	IC circuit	
				3-wire (PNP)			—	M9PW	●	●	●	○	○	○		
				2-wire	12 V		—	M9BW	●	●	●	○	○	—		
				3-wire (NPN)	5 V, 12 V		—	M9A**	○	○	●	○	○	○		IC circuit
				3-wire (PNP)	12 V		—	M9PA**	○	○	●	○	○	○		
				2-wire	12 V		—	M9BA**	○	○	●	○	○	○		—

** Water resistant type auto switches can be mounted on the above models, but in such case SMC cannot guarantee water resistance. Consult with SMC regarding water resistant types with the above model numbers.

* Lead wire length symbols: 0.5 m Nil (Example) M9N
1 m M (Example) M9NM
3 m L (Example) M9NL
5 m Z (Example) M9NZ

* Auto switches marked with "○" are produced upon receipt of order.

Note 1) For 2-color indicator, use caution on hysteresis. Refer to page 1281, "Auto Switch Hysteresis" prior to use.

Note 2) Refer to pages 1271 through to 1365 for detailed auto switch specifications.

* Auto switches are included, (but not assembled).

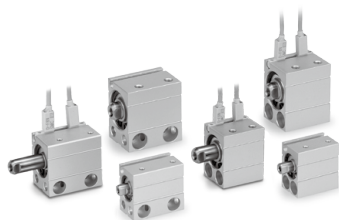

Symbol

Double acting, single rod, rubber bumper

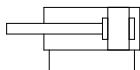

Single acting, spring return, rubber bumper

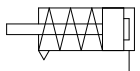

Single acting, spring extend, without cushion

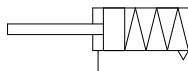

Made to Order

[Click here for details](#)

Symbol	Contents
-XA□	Change of Rod End Shape <small>Note 1)</small>
-XB6	Heat resistant cylinder (-10 to 150°C) <small>Note 2)</small>
-XC22	Fluororubber seals <small>Note 3)</small>

Note 1) Excluding single acting, spring extend type.

Note 2) Except models with auto switch and single acting, spring return/extend type.

Note 3) Excluding single acting, spring return/extend type.

A bumper is a standard product.

Theoretical Output: Double Acting

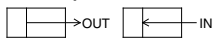

Unit: N

Bore size (mm)	Operating direction	Operating pressure MPa		
		0.3	0.5	0.7
12	OUT	34	57	79
	IN	25	42	59
16	OUT	60	101	141
	IN	45	75	106
20	OUT	94	157	220
	IN	71	118	165

Moisture Control Tube IDK Series



When operating an actuator with a small diameter and a short stroke at a high frequency, the dew condensation (water droplet) may occur inside the piping depending on the conditions.

Simply connecting the moisture control tube to the actuator will prevent dew condensation from occurring. For details, refer to the [Web Catalog](#).

Specifications

Bore size (mm)		12	16	20
Action		Double acting; Single acting, spring return/extend		
Fluid		Air		
Proof pressure		1.05 MPa		
Minimum operating pressure	Double acting	0.07 MPa		0.05 MPa
	Single acting, spring return/extend	0.25 MPa		0.18 MPa
Maximum operating pressure		0.7 MPa		
Ambient and fluid temperature		Without auto switch: -10 to 70°C (No freezing) With auto switch: -10 to 60°C (No freezing)		
Cushion		Rubber bumper (Double acting; Single acting, spring return), None (Single acting, spring extend)		
Lubrication		Non-lube		
Piston speed		50 to 500 mm/s*		
Stroke length tolerance		+1.0 0		
Mounting		CUJB: Through-hole (lateral, axial direction: 2 locations each) CUJS: Through-hole (axial direction: 2 locations)		

* Depending on the circuit condition, the piston speed may not reach the maximum speed.

Standard Stroke

Bore size (mm)	Operating direction	Standard stroke (mm)
12	Double acting	5, 10, 15, 20, 25, 30, 35, 40, 45, 50
16		
20		
12	Single acting, spring return/extend	5, 10
16		
20		

Theoretical Output: Spring Reaction Force/Single Acting

Action	Bore size (mm)	Rod size (mm)	Piston area (mm ²)	Stroke (mm)	Operating direction	Operating pressure (MPa)			Spring reaction force	
						0.3	0.5	0.7	Second	First
Spring return	12	6	113	5	OUT	24.5	47.5	69.5	9.5	6
				10					9.5	3.5
	16	8	201	5		49	90	130	11	7.5
				10					11	4.5
	20	10	314	5		77.5	140.5	203.5	16.5	10.5
				10					16.5	5.5
Spring extend	12	6	85	5	IN	13.5	30.5	47.5	11.5	3
				10					10	3
	16	8	151	5		25.5	55.5	86.5	19.5	5
				10					19.5	5
	20	10	236	5		43.5	90.5	137.5	27	5.5
				10					27.5	6

1. Single acting, spring return

Spring in pre-loaded condition

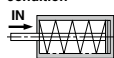

When the spring is set in the cylinder.

Spring in loaded condition

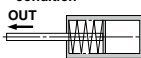

When the spring is contracted by applying air.

2. Single acting, spring extend

Spring in pre-loaded condition



When the spring is set in the cylinder.

Spring in loaded condition

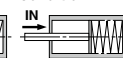

When the spring is contracted by applying air.

Weight

Double acting

Unit: g

Bore size (mm)	Standard stroke (mm)										Additional weight	
	5	10	15	20	25	30	35	40	45	50	Built-in magnet	Rod end male threaded
CUJ □ 12	21	26	31	35	40	45	50	55	60	65	6	4
CUJ □ 16	32	39	46	53	60	67	74	81	88	95	9	8
CUJ □ 20	52	62	72	82	92	102	112	122	132	142	12	13

Single acting

Unit: g

Action	Bore size (mm)	Standard stroke (mm)		Additional weight	
		5	10	Built-in magnet	Rod end male threaded
Spring return	12	23	28	6	4
	16	34	41	9	8
	20	53	63	11	13
Spring extend	12	23	28	6	2
	16	34	41	8	4
	20	59	68	9	7

Mounting

How to Mount: Through-hole mounting bolts are available.

How to Order: Add the "CUJB-" in front of the bolts to be used.

Example) CUJB-M5 x 30 L
(For CUJS20-5)

* The order number at above includes one mounting bolt and one spring washer.

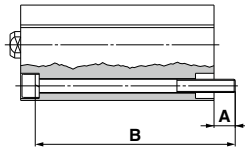

Axial mounting

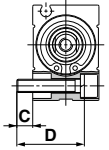
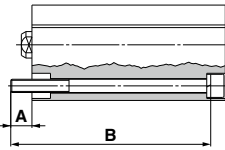

Lateral mounting

* When mounting the cylinder, be sure to use the included spring washer.

Without Auto Switch (Without Magnet)

For Axial Mounting

Material: Structural steel

Cylinder model	A	B	Mounting bolt size
CUJS12-5			
-10	8.5	25	M4 x 25 L
-15		30	M4 x 30 L
-20		35	M4 x 35 L
-25		40	M4 x 40 L
-30		45	M4 x 45 L
-35		50	M4 x 50 L
-40		55	M4 x 55 L
-45		60	M4 x 60 L
-50		65	M4 x 65 L
-50		70	M4 x 70 L
CUJS16-5			
-10	7.5	25	M4 x 25 L
-15		30	M4 x 30 L
-20		35	M4 x 35 L
-25		40	M4 x 40 L
-30		45	M4 x 45 L
-35		50	M4 x 50 L
-40		55	M4 x 55 L
-45		60	M4 x 60 L
-50		65	M4 x 65 L
-50		70	M4 x 70 L
CUJS20-5			
-10	10.5	30	M5 x 30 L
-15		35	M5 x 35 L
-20		40	M5 x 40 L
-25		45	M5 x 45 L
-30		50	M5 x 50 L
-35		55	M5 x 55 L
-40		60	M5 x 60 L
-45		65	M5 x 65 L
-50		70	M5 x 70 L
-50		75	M5 x 75 L

For Lateral Mounting

Material: Structural steel

Cylinder model	C	D	Mounting bolt size
CUJB12-5			
-10	8.5	20	M4 x 20 L
-15			
-20			
-25			
-30			
-35			
-40			
-45			
-50			
CUJB16-5			
-10	9.5	25	M4 x 25 L
-15			
-20			
-25			
-30			
-35			
-40			
-45			
-50			
CUJB20-5			
-10	7.5	25	M5 x 25 L
-15			
-20			
-25			
-30			
-35			
-40			
-45			
-50			

With Auto Switch (Built-in Magnet)

For Axial Mounting

Material: Structural steel

Cylinder model	A	B	Mounting bolt size
CDUJS12-5			
-10	9.5	30	M4 x 30 L
-15		35	M4 x 35 L
-20		40	M4 x 40 L
-25		45	M4 x 45 L
-30		50	M4 x 50 L
-35		55	M4 x 55 L
-40		60	M4 x 60 L
-45		65	M4 x 65 L
-50		70	M4 x 70 L
-50		75	M4 x 75 L
CDUJS16-5			
-10	8	30	M4 x 30 L
-15		35	M4 x 35 L
-20		40	M4 x 40 L
-25		45	M4 x 45 L
-30		50	M4 x 50 L
-35		55	M4 x 55 L
-40		60	M4 x 60 L
-45		65	M4 x 65 L
-50		70	M4 x 70 L
-50		75	M4 x 75 L
CDUJS20-5			
-10	11.5	35	M5 x 35 L
-15		40	M5 x 40 L
-20		45	M5 x 45 L
-25		50	M5 x 50 L
-30		55	M5 x 55 L
-35		60	M5 x 60 L
-40		65	M5 x 65 L
-45		70	M5 x 70 L
-50		75	M5 x 75 L
-50		80	M5 x 80 L

For Lateral Mounting

Material: Structural steel

Cylinder model	C	D	Mounting bolt size
CDUJB12-5			
-10	8.5	20	M4 x 20 L
-15			
-20			
-25			
-30			
-35			
-40			
-45			
-50			
CDUJB16-5			
-10	9.5	25	M4 x 25 L
-15			
-20			
-25			
-30			
-35			
-40			
-45			
-50			
CDUJB20-5			
-10	7.5	25	M5 x 25 L
-15			
-20			
-25			
-30			
-35			
-40			
-45			
-50			

■ Clean Series

How to Order

Double acting

10 - C D UJ B 12 - 30 D - F8N

Clean Series

10	Relieving type
11	Vacuum type

Built-in magnet

Nil	None
D	Yes (Built-in)

Number of auto switches

Nil	2 pcs.
S	1 pc.

* M9□: with 1 pc.

Auto switch

Nil	Without auto switch
-----	---------------------

* Applicable auto switch models are the same as those for the standard, double acting type. Refer to page 709.

Bore size

12	12 mm
16	16 mm
20	20 mm

Mounting direction

B Lateral mounting

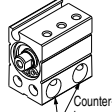

S Axial mounting

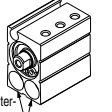

Stroke

Bore size (mm)	Stroke (mm)									
	5	10	15	20	25	30	35	40	45	50
12	●	●	●	●	●	●	—	—	—	—
16	●	●	●	●	●	●	—	—	—	—
20	●	●	●	●	●	●	●	●	●	●

* Contact SMC for strokes other than those shown above.

For detailed specifications, refer to the [Web Catalog](#).

Specifications

The specifications are the same as those for the standard, double acting type. Refer to page 710. However, the operating piston speed is ranged from 50 to 400 mm/s.

Dimensions

Lateral mounting/C□UJB

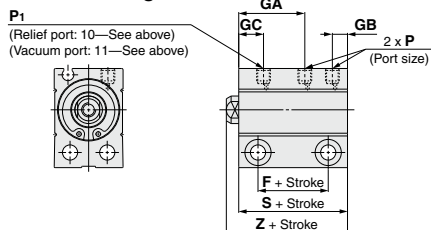

Bore size (mm)	Without magnet (mm)			
	F	GA	S	Z
12	11.5	15.5	23.5	27
16	13.5	17.5	25.5	29
20	15.5	18.5	29.5	34

Bore size (mm)	Built-in magnet (mm)			
	F	GA	S	Z
12	15.5	15.5	27.5	31
16	18	18	30	33.5
20	19.5	18.5	33.5	38

Axial mounting/C□UJS

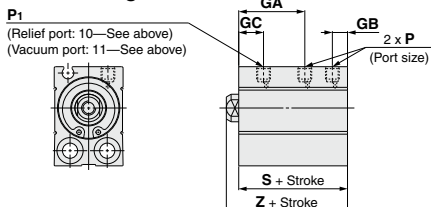

Bore size (mm)	(mm)			
	GC	GB	P ₁	P
12	7	4	M3 x 0.5	M3 x 0.5
16	8.5	4	M3 x 0.5	M3 x 0.5
20	8.5	5.5	M5 x 0.8	M5 x 0.8



Construction

Double Acting

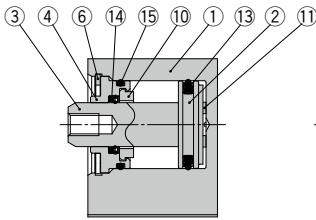

Without magnet

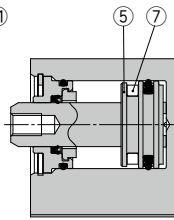

Built-in magnet

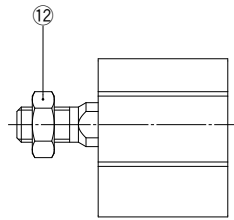

Rod end male threaded

Single Acting, Spring Return

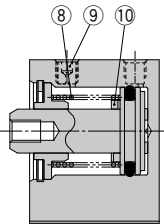

Without magnet

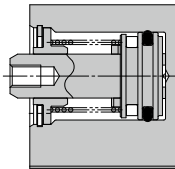

Built-in magnet

Single Acting, Spring Extend

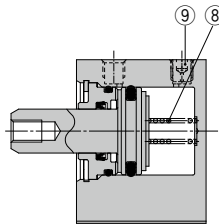

Without magnet

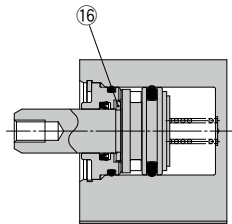

Built-in magnet

Component Parts

No.	Description	Material	Note
1	Cylinder tube	Aluminum alloy	Hard anodized
2	Piston	Aluminum alloy	Trivalent chromated
3	Piston rod	Stainless steel	
4	Collar	Aluminum alloy	Hard anodized
5	Magnet holder	Aluminum alloy	Trivalent chromated
6	Retaining ring	Steel for special applications	Phosphate coated
7	Magnet	—	
8	Return spring	Steel wire	Zinc trivalent chromated
9	Element	Bronze casted	(for ø12, ø16)
9	Plug with fixed restrictor	Structural steel	Nickel plated (for ø20)
10	Damper A	Resin	
11	Damper B	Resin	
12	Rod end nut	Steel wire	Chromated
13	Piston seal	NBR	
14	Rod seal	NBR	
15	O-ring	NBR	
16	Retaining ring	Steel for special applications	Nickel plated

Replacement Parts: Seal Kit

Double Acting

Bore size (mm)	Kit no.	Contents
12	CUJB12-PS	Set of 13, 14, 15 and grease pack.
16	CUJB16-PS	
20	CUJB20-PS	

Single Acting, Spring Return

Bore size (mm)	Kit no.	Contents
12	CUJB12-S-PS	Set of 13 and grease pack.
16	CUJB16-S-PS	
20	CUJB20-S-PS	

Single Acting, Spring Extend

Bore size (mm)	Kit no.	Contents
12	CUJB12-T-PS	Set of 13, 14, 15 and grease pack.
16	CUJB16-T-PS	
20	CUJB20-T-PS	

* Use the following part number for ordering a grease pack only.
Grease part no.: GR-L-005 (5 g)

CUJ Series

Dimensions: $\phi 12$, $\phi 16$, $\phi 20$ Double Acting

Lateral Mounting

Without Magnet: CUJB□-□D

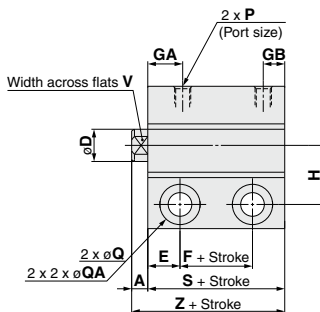
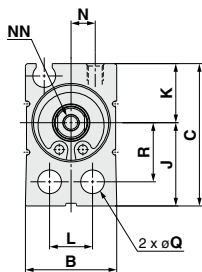

Built-in Magnet: CDUJB□-□D

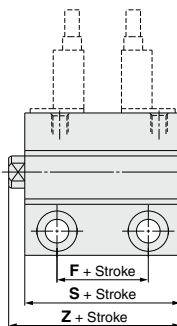
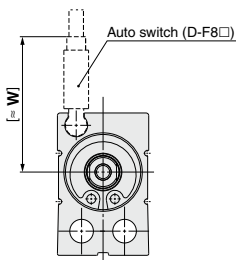

Rod end male threaded

Rod end nut

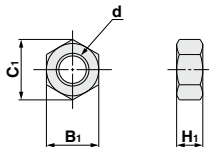
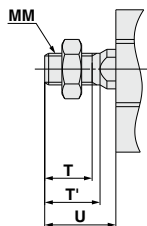

Part no.	Bore size (mm)	d	H ₁	B ₁	C ₁
NTJ-015C	12	M5 x 0.8	4	8	9.2
NT-015A	16	M6 x 1	5	10	11.5
NT-02	20	M8 x 1.25	5	13	15

Bore size (mm)	A	B	C	D	E	GB	H	J	K	L	MM	NN	N	P	Q
12	3.5	17	26.5	6	6	4	11	15.5	11	8	M5 x 0.8	M3 x 0.5 effective depth of thread 6	3.5	M3 x 0.5	4.4 through
16	3.5	21	29.5	8	6	4	12.5	17	12.5	11.5	M6 x 1	M4 x 0.7 effective depth of thread 8	5.5	M3 x 0.5	4.4 through
20	4.5	25	36	10	7	5.5	15.5	21	15	13.5	M8 x 1.25	M5 x 0.8 effective depth of thread 7	7	M5 x 0.8	5.5 through

Bore size (mm)	QA	R	T	T'	U	V	W	Without magnet				Built-in magnet			
								F	GA	S	Z	F	GA	S	Z
12	7.5 depth, depth of counterbore 7	11	9	10.5	14	5	26	3.5	7.5	15.5	19	7.5	7.5	19.5	23
16	7.5 depth, depth of counterbore 7	12.5	10	12	15.5	6	27.5	4	8.5	16.5	20	8.5	9	21	24.5
20	9.5 depth, depth of counterbore 9	15.5	12	14	18.5	8	30	5.5	8.5	19.5	24	9.5	8.5	23.5	28

Axial Mounting

Without Magnet: CUJS□□□D

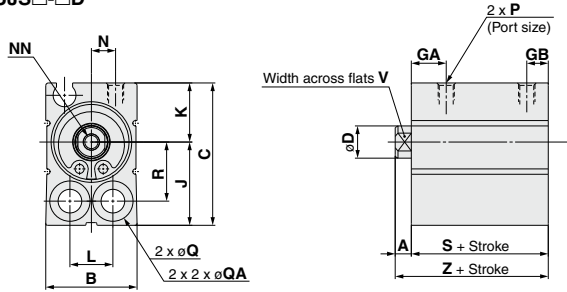

Built-in Magnet: CDUJS□□□D

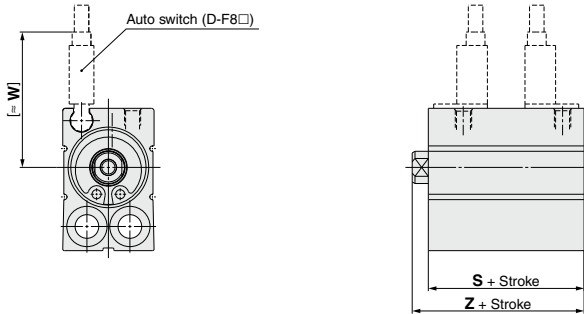

Rod end male threaded

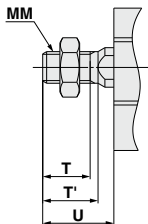

Note) Refer to page 714 for details on rod end nuts.

Bore size (mm)	(mm)													
	A	B	C	D	GB	J	K	L	MM	NN	N	P	Q	QA
12	3.5	17	26.5	6	4	15.5	11	8	M5 x 0.8	M3 x 0.5 effective depth of thread 6	3.5	M3 x 0.5	4.4 through	7.5 depth, depth of counterbore 5.5
16	3.5	21	29.5	8	4	17	12.5	11.5	M6 x 1	M4 x 0.7 effective depth of thread 8	5.5	M3 x 0.5	4.4 through	7.5 depth, depth of counterbore 5.5
20	4.5	25	36	10	5.5	21	15	13.5	M8 x 1.25	M5 x 0.8 effective depth of thread 7	7	M5 x 0.8	5.5 through	9.5 depth, depth of counterbore 6.5

Bore size (mm)	R	T	T'	U	V	W	Without magnet			Built-in magnet		
							GA	S	Z	GA	S	Z
12	11	9	10.5	14	5	26	7.5	15.5	19	7.5	19.5	23
16	12.5	10	12	15.5	6	27.5	8.5	16.5	20	9	21	24.5
20	15.5	12	14	18.5	8	30	8.5	19.5	24	8.5	23.5	28

CUJ Series

Dimensions: $\phi 12$, $\phi 16$, $\phi 20$ Single Acting, Spring Return/Extend

Lateral Mounting

Without Magnet: CUJB□-□S/T

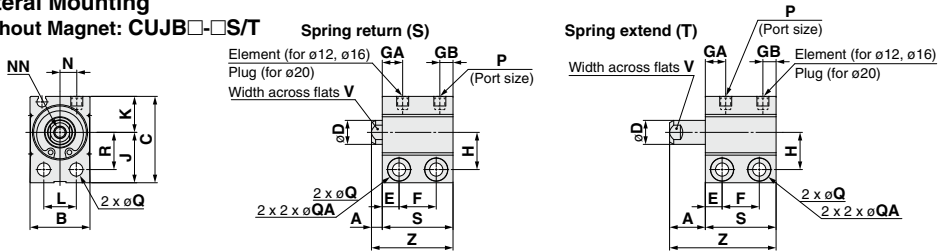

Built-in Magnet: CDUJB□-□S/T

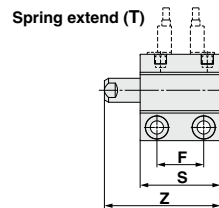
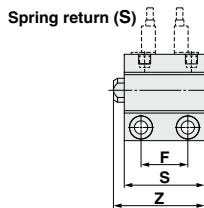
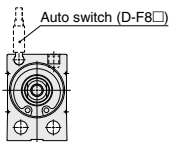

Rod end male threaded

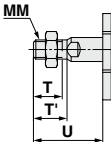

Note) Refer to page 714 for details on rod end nuts.

CUJB□-□S/T Common Dimensions

(mm)

Bore size (mm)	B	C	D	E	GB	H	J	K	L	MM	NN	N	P	Q	QA
12	17	26.5	6	6	4	11	15.5	11	8	M5 x 0.8	M3 x 0.5 effective depth of thread 6	3.5	M3 x 0.5	4.4 through	7.5 depth, depth of counterbore 7
16	21	29.5	8	6	4	12.5	17	12.5	11.5	M6 x 1	M4 x 0.7 effective depth of thread 8	5.5	M3 x 0.5	4.4 through	7.5 depth, depth of counterbore 7
20	25	36	10	7	5.5	15.5	21	15	13.5	M8 x 1.25	M3 x 0.8 effective depth of thread 7	7	M5 x 0.8	5.5 through	9.5 depth, depth of counterbore 9

Bore size (mm)	R	T	T'	V	W	Without magnet	Built-in magnet
						GA	GA
12	1.1	9	10.5	5	26	7.5	7.5
16	12.5	10	12	6	27.5	8.5	9
20	15.5	12	14	8	30	8.5	8.5

Spring Return CUJB□-□S

(mm)

Bore size (mm)	A	U	Without magnet								Built-in magnet							
			F		S		Z		F		S		Z					
			5 st	10 st	5 st	10 st	5 st	10 st	5 st	10 st	5 st	10 st	5 st	10 st				
12	3.5	14	10	15	22	27	25.5	30.5	14	19	26	31	29.5	34.5				
16	3.5	15.5	9	14	21.5	26.5	25	30	13.5	18.5	26	31	29.5	34.5				
20	4.5	18.5	10.5	15.5	24.5	29.5	29	34	14.5	19.5	28.5	33.5	33	38				

Spring Extend CUJB□-□T

(mm)

Bore size (mm)	A		U		Without magnet						Built-in magnet					
	F		S		Z		F		S		Z					
	5 st	10 st	5 st	10 st	5 st	10 st	5 st	10 st	5 st	10 st	5 st	10 st				
12	8.5	13.5	19	24	8.5	13.5	20.5	25.5	29	39	12.5	17.5	24.5	29.5	33	43
16	8.5	13.5	20.5	25.5	9	14	21.5	26.5	30	40	13.5	18.5	26	31	34.5	44.5
20	9.5	14.5	23.5	28.5	10.5	15.5	24.5	29.5	34	44	14.5	19.5	28.5	33.5	38	48

Axial Mounting

Without magnet: **CUJS□-□S/T**

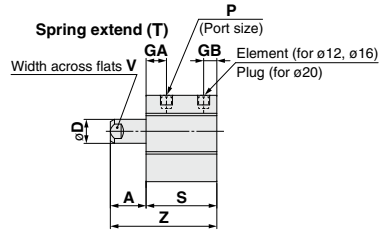
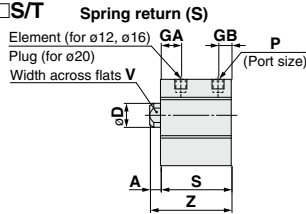
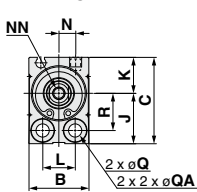

Built-in magnet: **CDUJS□-□S/T**

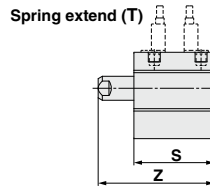
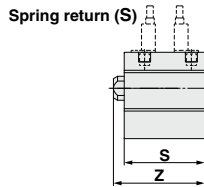
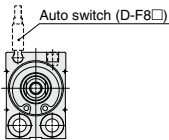

Rod end male threaded

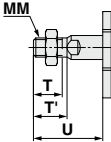

Note) Refer to page 714 for details on rod end nuts.

CUJS□-□S/T Common Dimensions

(mm)

Bore size (mm)	B	C	D	GB	J	K	L	MM	NN	N	P	Q	QA
12	17	26.5	6	4	15.5	11	8	M5 x 0.8	M3 x 0.5 effective depth of thread 6	3.5	M3 x 0.5	4.4 through	Depth 5.5
16	21	29.5	8	4	17	12.5	11.5	M6 x 1	M4 x 0.7 effective depth of thread 8	5.5	M3 x 0.5	4.4 through	Depth 5.5
20	25	36	10	5.5	21	15	13.5	M8 x 1.25	M3 x 0.8 effective depth of thread 7	7	M5 x 0.8	5.5 through	Depth 6.5

Bore size (mm)	R	T	T'	V	W	Without magnet		Built-in magnet	
						GA	GA	GA	GA
12	1.1	9	10.5	5	26	7.5	7.5		
16	12.5	10	12	6	27.5	8.5	9		
20	15.5	12	14	8	30	8.5	8.5		

Spring Return CUJS□-□S

(mm)

Bore size (mm)	A	U	Without magnet				Built-in magnet			
			S		Z		S		Z	
			5 st	10 st	5 st	10 st	5 st	10 st	5 st	10 st
12	3.5	14	22	27	25.5	30.5	26	31	29.5	34.5
16	3.5	15.5	21.5	26.5	25	30	26	31	29.5	34.5
20	4.5	18.5	24.5	29.5	29	34	28.5	33.5	33	38

Spring Extend CUJS□-□T

(mm)

Bore size (mm)	A		U		Without magnet				Built-in magnet			
					S		Z		S		Z	
	5 st	10 st	5 st	10 st	5 st	10 st	5 st	10 st	5 st	10 st	5 st	10 st
12	8.5	13.5	5	24	20.5	25.5	29	39	24.5	29.5	33	43
16	8.5	13.5	20.5	25.5	21.5	26.5	30	40	26	31	34.5	44.5
20	9.5	14.5	23.5	28.5	24.5	29.5	34	44	28.5	33.5	38	48

Auto Switch Mounting

Auto Switch: Proper Mounting Position (Detection at Stroke End)

D-F8□

D-M9□/M9□W/M9□A

• When detecting extended stroke end

• When detecting retracted stroke end

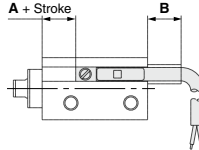
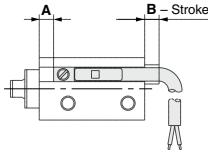
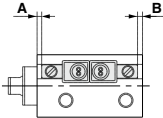

Bore size (mm)	D-F8□						D-M9□/M9□W D-M9□A					
	Double acting		Single acting, Spring return		Single acting, Spring extend		Double acting		Single acting, Spring return		Single acting, Spring extend	
	A	B	A	B	A	B	A	B	A	B	A	B
6												
8	1	1	1	1	—	—	3	7	3	7	—	—
10												
12	2	1	3.5	1	2	1	4	7	5.5	7	4	7
16	3	1	3	1	3	1	5	6.5	5	6.5	5	6.5
20	5	2	5	2	5	2	7	6	7	6	7	6

Note 1) Solid state switch D-M9□/M9□W/M9□A: with 1 pc.
 Note 2) Adjust the mounting position after confirming the auto switch operation.

Auto Switch Mounting

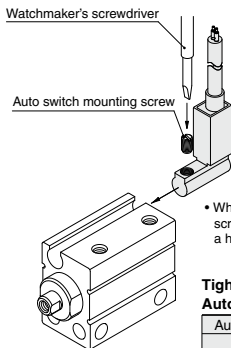

• When tightening an auto switch mounting screw, use a watchmaker's screwdriver with a handle of approx. 5 to 6 mm in diameter.

Tightening Torque for Auto Switch Mounting Screw (N·m)

Auto switch model	Tightening torque
D-F8□	0.10 to 0.20
D-M9□	
D-M9□W	0.05 to 0.15
D-M9□A	0.05 to 0.10

Operating Range

Auto switch model	Applicable bore size (mm)					
	6	8	10	12	16	20
D-F8□	2	2.5	2.5	3	4	4
D-M9□						
D-M9□W	3	3.5	3.5	4	4	5
D-M9□A						

* This is a guideline including hysteresis, not meant to be guaranteed. (assuming approx. ±30% dispersion)

This will vary substantially depending on the ambient environment.

Caution on Proximity Installation

1. When cylinders with auto switches are adjacent to one another as shown in the figure below, provide a space between them of at least, the amount shown in the tables below.

If the space is not sufficient, the magnets in adjacent cylinders may cause the auto switches to malfunction.

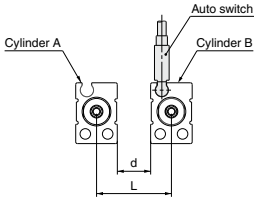

Without Shielding Plate

Bore	ø6	ø8	ø10	ø12	ø16	ø20
L	19	19	19.5	21	25	29
d	6	6	6	4	4	4

With Shielding Plate

Bore	ø6	ø8	ø10	ø12	ø16	ø20
L	16	13.5	14	18	22	26
d	3	0.5	0.5	1	1	1

- * The space can be reduced by attaching a shielding plate (steel plate 0.2 to 0.3 mm thick) to the side of the cylinder. In the case of a ø6 bore size, be sure to attach the shielding plate on Cylinder A (on the surface opposite to the switch groove).

Shown below is the dimensions of the separately sold shielding plate (MU-S025) for reference.

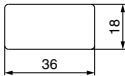

Material: Ferritic stainless steel, thickness: 0.3 mm
Possible to attach this on the cylinder since the reverse side is treated with glue.

2. In the case of ø6 bore size cylinders with auto switches, keep the auto switch groove side surface at least 2.5 mm away from a magnetic substance.

If a magnetic material gets closer within 2.5 mm, the auto switches may malfunction due to a drop in magnetic force.

- * If this surface is to be used for mounting, a spacer composed of a non-magnetic substance (aluminum, etc.) is required as shown in the figure below.

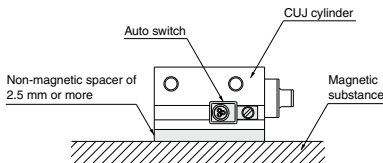



CUJ Series

Specific Product Precautions 1

Be sure to read this before handling the products. Refer to page 20 for safety instructions and pages 21 to 30 for actuator and auto switch precautions.

Design

⚠ Warning

Do not use an exhaust center. If its use cannot be avoided, use an lurching-prevention circuit, or consult SMC.

Mounting

⚠ Caution

1. When mounting a mini free mount cylinder, tighten the bolts with the proper tightening torque.

Applicable bore size (mm)	Bolt	Proper tightening torque (N·m)*
4	M2.5 x 0.45	0.54 ±20% (0.432 to 0.648)
6	M3 x 0.5	1.06 ±20% (0.848 to 1.272)
8		
10		
12	M4 x 0.7	3.27 ±20% (2.61 to 3.92)
16		
20	M5 x 0.8	6.6 ±20% (5.28 to 7.92)

* Torque coefficient: 0.2

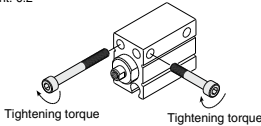

2. Mounting the bolt from the rod side with a $\phi 12$ to $\phi 20$ lateral mounting body may result in interference with the workpiece. Use an axial mounting body.

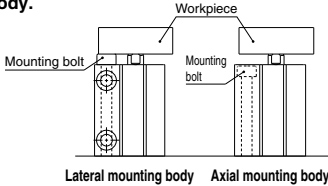

3. Use caution especially when multiple cylinders are used in parallel such as stacking because the dimensions of the body's width have plus tolerances. Contact us for information on a product with body width dimensions having different tolerances. ($\phi 4$, $\phi 6$, $\phi 8$, $\phi 10$ only)

4. If the cylinder's mounting surface is not sufficiently flat, it may result in malfunction. We recommend that the cylinder's mounting surface flatness should be 1/100 mm or less.

5. When mounting the product laterally, mount the product so that the entire surface on the cylinder side is in contact with the cylinder mounting plate.

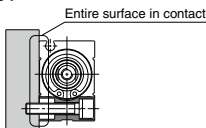

Allowable Kinetic Energy

⚠ Caution

When driving an inertial load, operate a cylinder with kinetic energy within the allowable value. The range in the chart below that is delineated by bold solid lines indicates the relationship between load mass and maximum driving speeds.

Bore size (mm)	4	6	8	10	12	16	20
Piston speed (m/s)	0.05 to 0.5						
Allowable kinetic energy (J)	3.8×10^{-3}	6.25×10^{-3}	9.35×10^{-3}	12.5×10^{-3}	0.030	0.053	0.077

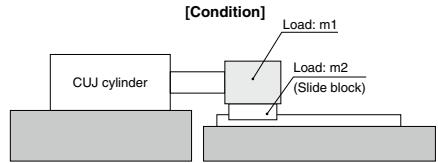
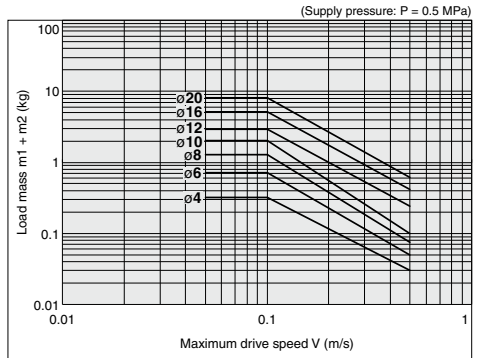

Single Acting Cylinders

⚠ Caution

1. Do not move the load with the thrust (spring reaction force) on the cylinder retracting side. Otherwise, it will cause poor stroke or malfunction.
2. Do not remove the element or plug.



CUJ Series Specific Product Precautions 2

Be sure to read this before handling the products. Refer to page 20 for safety instructions and pages 21 to 30 for actuator and auto switch precautions.

Selection

Strictly observe the limiting range of lateral load on a piston rod. (Refer to the graphs below.) If this product is used beyond the limits, it may shorten the machine life or cause damage.

Double Acting, Female Threaded, Without Magnet (Without Auto Switch)

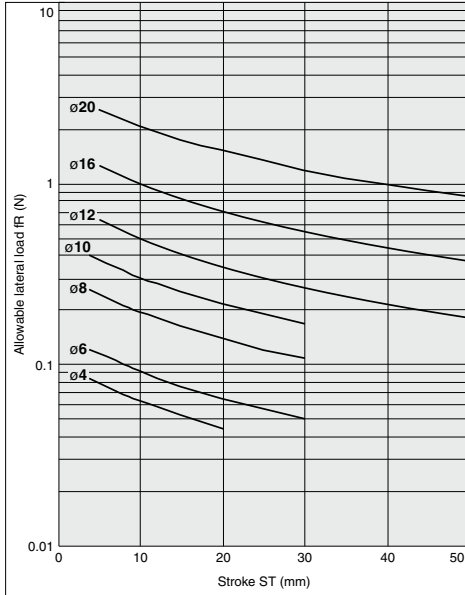

Double Acting, Female Threaded, With Magnet (With Auto Switch)

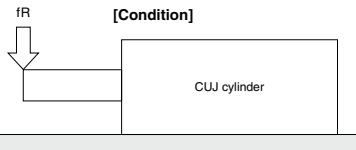
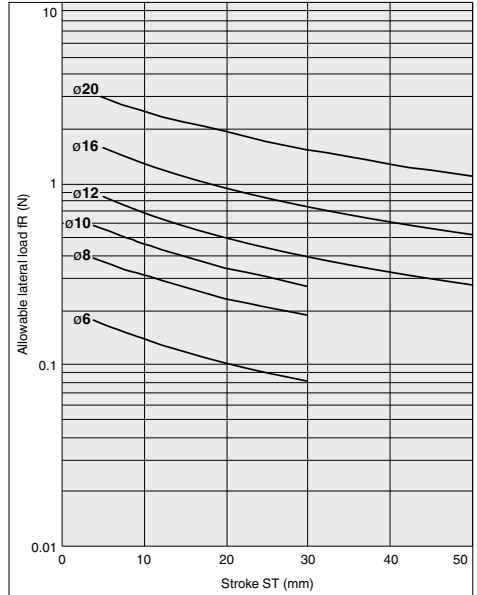

⚠ Caution

Adjust the cylinder drive speed by installing a speed controller, beginning at a low speed and gradually adjusting to the specified speed.

Lubrication

⚠ Caution

Lubrication to the non-lube type cylinders

Lubrication is not necessary since these cylinders are lubricated at the factory.

However, when you lubricate the cylinder, use synthetic oil (polyalphaolefin oil or equivalent). In that case, continue to lubricate the cylinder. Otherwise, loss of the initial lubricant may result in malfunction.

* Oil lubrication is not possible with the clean series.



CUJ Series

Specific Product Precautions 3

Be sure to read this before handling the products. Refer to page 20 for safety instructions and pages 21 to 30 for actuator and auto switch precautions.

Caution on Mounting Speed Controllers and Fittings

⚠ Caution

Since the cylinder port size of M3 x 0.5 (M5 x 0.8 for $\phi 20$ only) is used, use the cylinder series models listed below when connecting speed controllers and fittings directly to cylinders.

- After manually tightening speed controllers and fittings, tighten approximately a quarter turn (a 1/6 turn for $\phi 20$ only) more using a tightening tool. In cases where there are gaskets in two places such as universal elbows, universal tees, etc., double the additional tightening to a half turn (a 1/3 turn for $\phi 20$ only). If screws are tightened excessively, air leakage may result due to broken threads or a deformed gasket. If screws are tightened insufficiently, looseness and accompanying air leakage are likely to occur.

<Speed Controllers>

With Magnet (With Auto Switch)

Bore size (mm)	6, 8, 10	12, 16	20
Port size	M3 x 0.5		M5 x 0.8
Stroke (mm)	4 or more	5 or more	5 or more
AS12□1F-M3-02	●	●	—
AS12□1F-M5-02	—	—	●
AS12□1F-M3-23	○	●	—
AS12□1F-M5-23	—	—	●
AS12□1F-M3-04	○	●	—
AS12□1F-M5-04	—	—	●
AS12□1F-M5-06	—	—	●
AS13□1F-M3-23	○	●	—
AS13□1F-M3-04	○	●	—
AS13□1F-M5-23	—	—	●
AS13□1F-M5-04	—	—	●
AS13□1F-M5-06	—	—	●

- : Applicable to mounting condition 1, 2, 3 and 4.
- : Applicable to mounting condition 1 and 3.

Without Magnet (Without Auto Switch)

Bore size (mm)	4, 6, 8, 10			12, 16	20
Port size	M3 x 0.5				M5 x 0.8
Stroke (mm)	4	6	8 or more	5 or more	5 or more
AS12□1F-M3-02	○	○	○	●	—
AS12□1F-M5-02	—	—	—	—	●
AS12□1F-M3-23	—	○	○	●	—
AS12□1F-M5-23	—	—	—	—	●
AS12□1F-M3-04	—	—	○	●	—
AS12□1F-M5-04	—	—	—	—	●
AS12□1F-M5-06	—	—	—	—	●
AS13□1F-M3-23	—	○	○	●	—
AS13□1F-M3-04	—	—	○	●	—
AS13□1F-M5-23	—	—	—	—	●
AS13□1F-M5-04	—	—	—	—	●
AS13□1F-M5-06	—	—	—	—	●

- : Applicable to mounting condition 1, 2, 3 and 4.
- : Applicable to mounting condition 1 and 3.

Fig. (1)

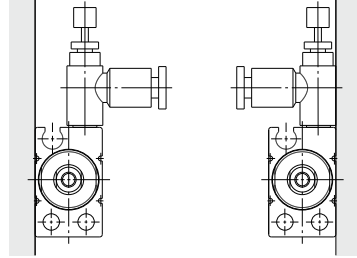

Mounting condition 1

Mounting condition 2

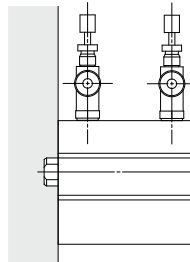

Mounting condition 3

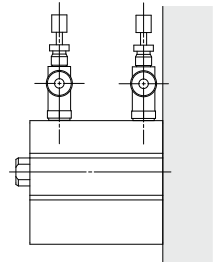

Mounting condition 4



CUJ Series Specific Product Precautions 4

Be sure to read this before handling the products. Refer to page 20 for safety instructions and pages 21 to 30 for actuator and auto switch precautions.

Caution on Mounting Speed Controllers and Fittings

<One-touch Fittings and Hose Nipples>

With Magnet (With Auto Switch)

Bore size (mm)		6, 8, 10			12, 16		20	
Port size		M3 x 0.5					M5 x 0.8	
Stroke (mm)		4	6 or more	5 or more	5	10 or more		
Male connector (with hexagon socket head)	KQ2S02-M3G	●	●	●	—	—		
	KQ2S23-M3G	●	●	●	—	—		
	KQ2S23-M5□	—	—	—	●	●		
	KQ2S04-M3G	△	△	●	—	—		
	KQ2S04-M5□	—	—	—	●	●		
Male connector	KQ2S06-M5□	—	—	—	●	●		
	KQ2H02-M3G	●	●	●	—	—		
	KQ2H02-M5□	—	—	—	●	●		
	KQ2H23-M3G	△	△	●	—	—		
	KQ2H23-M5□	—	—	—	●	●		
	KQ2H04-M3G	△	△	△	—	—		
	KQ2H04-M5□	—	—	—	●	●		
Barb fitting	KQ2H06-M5	—	—	—	△	△		
	M-3AU-3&4	●	●	●	—	—		
	M-3ALU-3&4	●	●	●	—	—		
	M-5AU-3&4&6	—	—	—	●	●		
M-5ALU-3&4&6	—	—	—	●	●			

- : Applicable to mounting condition 1, 2, 3 and 4.
- : Applicable to mounting condition 1, 2 and 3.
- △ : Applicable to mounting condition 1 and 3.
- * During actual operation, use the speed control device circuit.

Without Magnet (Without Auto Switch)

Bore size (mm)		4		6, 8, 10		12, 16		20	
Port size		M3 x 0.5					M5 x 0.8		
Stroke (mm)		4	6 or more	4	6 or more	5	10 or more	5	10 or more
Male connector (with hexagon socket head)	KQ2S02-M3G	●	●	●	●	●	●	—	—
	KQ2S23-M3G	●	●	●	●	●	●	—	—
	KQ2S23-M5□	—	—	—	—	—	—	●	●
	KQ2S04-M3G	—	○	—	△	●	●	—	—
	KQ2S04-M5□	—	—	—	—	—	—	●	●
Male connector	KQ2S06-M5□	—	—	—	—	—	—	●	●
	KQ2H02-M3G	●	●	●	●	●	●	—	—
	KQ2H02-M5□	—	—	—	—	—	—	●	●
	KQ2H23-M3G	—	○	—	△	●	●	—	—
	KQ2H23-M5□	—	—	—	—	—	—	●	●
	KQ2H04-M3G	—	○	—	△	—	△	—	—
	KQ2H04-M5□	—	—	—	—	—	—	●	●
Male elbow	KQ2H06-M5	—	—	—	—	—	—	—	△
	KQ2L02-M3G	●	●	●	●	●	●	—	—
	KQ2L02-M5□	—	—	—	—	—	—	●	●
	KQ2L23-M3G	—	○	—	△	●	●	—	—
	KQ2L23-M5□	—	—	—	—	—	—	●	●
	KQ2L04-M3G	—	○	—	△	●	●	—	—
Barb fitting	KQ2L04-M5□	—	—	—	—	—	—	●	●
	KQ2L06-M5□	—	—	—	—	—	—	●	●
	M-3AU-3&4	●	●	●	●	●	●	—	—
	M-5AU-3&4&6	—	—	—	—	—	—	●	●
M-3ALU-3&4	●	●	●	●	●	●	—	—	
M-5ALU-3&4&6	—	—	—	—	—	—	●	●	

- : Applicable to mounting condition 1, 2, 3 and 4.
- : Applicable to mounting condition 1, 2 and 3.
- △ : Applicable to mounting condition 1 and 3.
- * During actual operation, use the speed control device circuit.

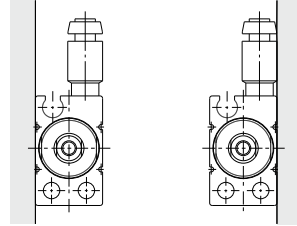

Mounting condition 1

Mounting condition 2

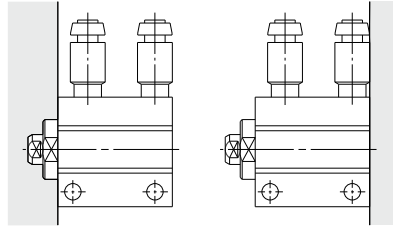

Mounting condition 3

Mounting condition 4

- * The above figures show the mounting conditions with the KJS One-touch fittings.
- ** Refer to the [Web Catalog](#) for details One-touch fittings and hose nipples.