

# Rotary Clamp Cylinder

## MK Series

ø12, ø16, ø20, ø25, ø32, ø40, ø50, ø63

Allowable moment of inertia **3** times higher  
New structure! MK series

Overall length is the same as the previous products! Mounting dimensions are interchangeable with the previous MK series.



Possible to mount small auto switches on **4** surfaces

- Auto switches can be mounted on any of the **4** surfaces to suit the installation conditions (**2** surfaces for ø20 and ø25).
- No projection of auto switch



### 2-color indicator solid state auto switch

Accurate setting of the mounting position can be performed without mistakes.

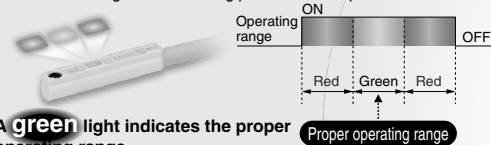

A **green** light indicates the proper operating range.

Application Example

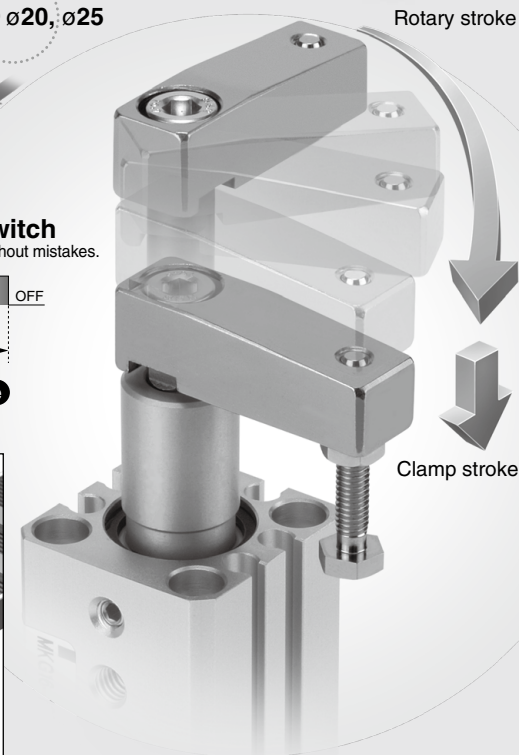
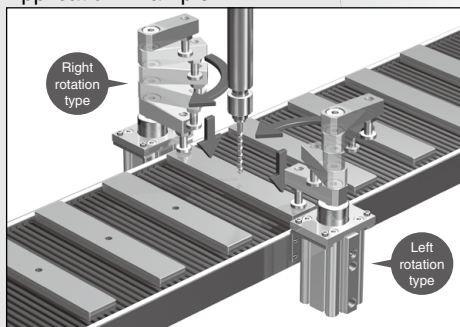

Allowable moment of inertia **3 times higher**

Allowable moment of inertia is the same as the heavy-duty MK2 series.

Allowable Moment of Inertia ( $\phi 32, \phi 40$ )

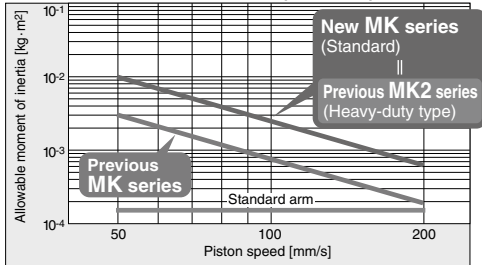

Maintenance can be performed for all sizes.

Seal kit and guide pin are replaceable.

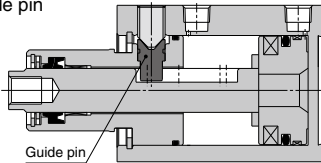

Standard stroke range has been expanded.

Manufacturable strokes have been newly added, making a wide range of strokes available. (★ indicates the added strokes.)

	Bore size	Stroke			
		10	20	30	50
MK	12	●	●	★	—
	16	●	●	★	—
	20	●	●	★	—
	25	●	●	★	—
	32	●	●	★	★
	40	●	●	★	★
	50	★	●	★	●
	63	★	●	★	●

## Mounting method

■ Flange mounting

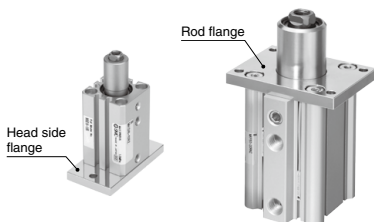

■ Direct mounting

2 types of cylinder mounting, through-hole mounting and tap mounting, are available for mounting the cylinder.

\* For the tap mounting, the thread length is different from the previous product.

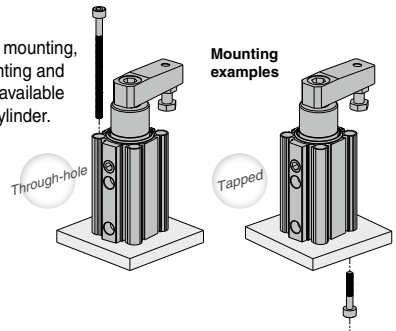

Overall length is shortened.  
 (equivalent to the previous MK series)

3 to 10 mm shorter than the previous MK2 series, making the product more compact.

■ Overall length comparison

Overall length is shortened.

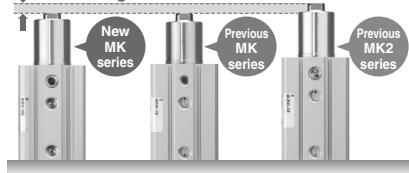

■ Overall Length Dimensions

Bore size	Shortened dimensions (compared to the previous MK2 series)	MK series overall length (at 20st)
20	3 mm	112.5
25	5 mm	113.5
32	8 mm	133.5
40	8 mm	134.5
50	10 mm	152
63	10 mm	155

Magnetic field resistant auto switch can be used.

Applicable to the D-P3DWA type

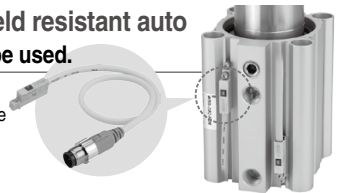

Clamping rotary direction can be selected from 2 types.

Clamping rotary direction can be selected to suit the setting conditions.

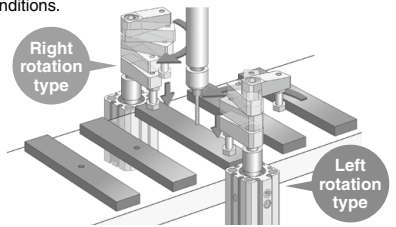

# MK Series Model Selection

Item	Series	MK
Max. piston speed <sup>Note)</sup> [mm/s]	ø12 to ø63	200
Non-rotating accuracy (Clamp part)	ø12	±1.4°
	ø16 to ø25	±1.2°
	ø32, ø40	±0.9°
	ø50, ø63	±0.7°
Rotary angle		90°±10°
Horizontal mounting		Not allowed

Note) Maximum piston speed indicates the maximum speed possible when employing a standard arm.

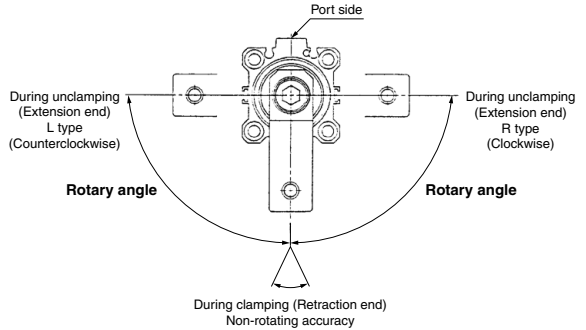

## Designing Arms

### ⚠ Caution

When arms are to be made separately, their length and weight should be within the following range.

#### 1. Allowable bending moment

Use the arm length and operating pressure within **Graph (1)** for allowable bending moment loaded piston rod.

Graph (1)

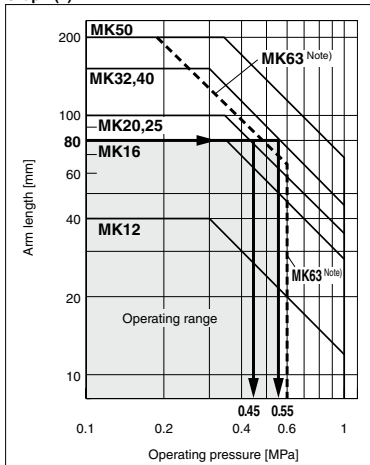

- When the arm length is 80 mm, pressure should be MK20/25: 0.45 MPa or less, MK32/40: 0.55 MPa or less.

Note) Use ø63 within a pressure range from 0.1 to 0.6 MPa. If ø63 is used within a pressure range from 0.61 to 1 MPa, please use -X2071.



#### 2. Moment of inertia

When the arm is long and heavy, damage of internal parts may be caused due to inertia. Use the moment of inertia and cylinder speed within **Graph (2)** based on arm requirements.

Graph (2)

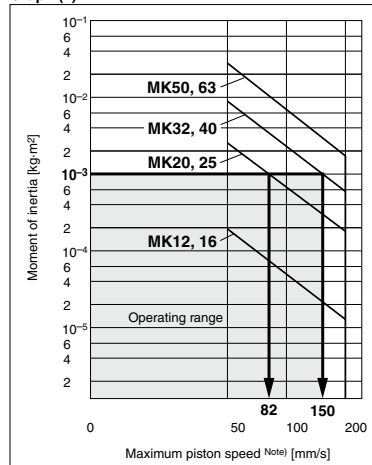

- When the arm's moment of inertia is  $1 \times 10^{-3} \text{ kg}\cdot\text{m}^2$ , cylinder speed should be MK20/25: 82 mm/s or less, MK32/40: 150 mm/s or less.

• For calculating the moment of inertia, refer to page 401.  
Note) Maximum piston speed is equivalent to approximately 1.6x the average piston speed. (Rough indication)

# MK Series

## Moment of Inertia

Note 1) Maximum piston speed is equivalent to approximately 1.6x the average piston speed. (Rough indication)

Note 2) The moment of inertia of the standard arm single unit is the value for the arm only. The values of accessories are not included.

Calculate the operating conditions and operate this product within the allowable range.

If the allowable range is exceeded, increase the bore size or use the MK2T series.

(Refer to page 419 for details of the MK2T series.)

### ø12, ø16

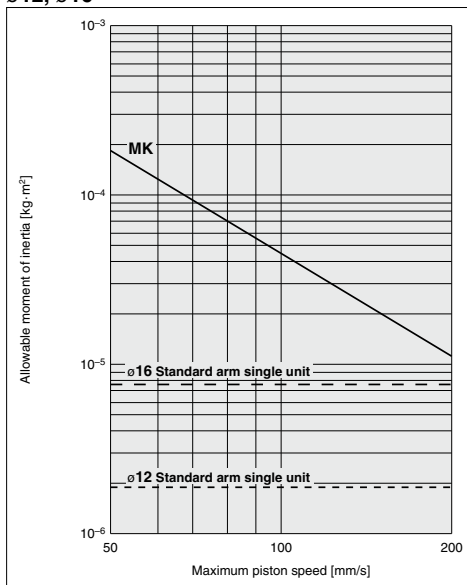

### ø20, ø25

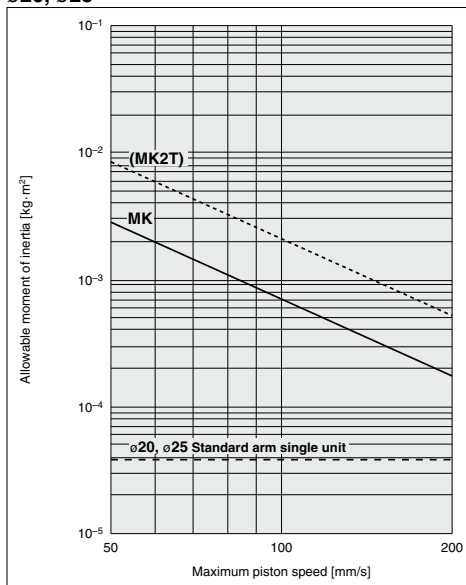

### ø32, ø40

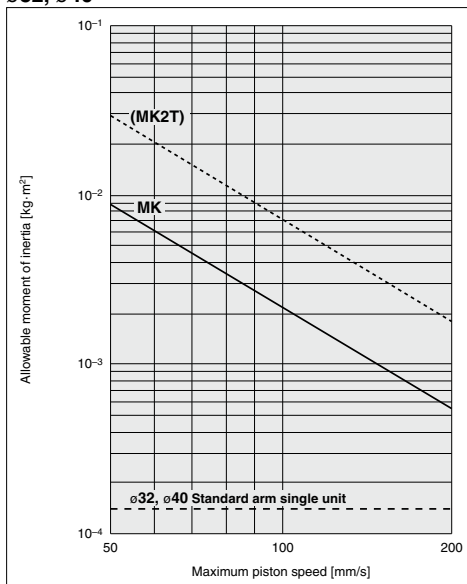

### ø50, ø63

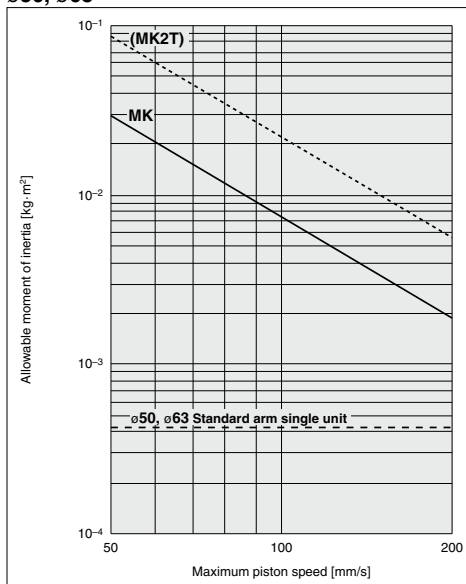

## Moment of Inertia

(Note) Maximum piston speed is equivalent to approximately 1.6x the average piston speed. (Rough indication)

Calculation example when arms other than the options are used.

- Calculate the moment of inertia of the arm.

$$I_1 = m_1 \cdot \frac{A^2 + B^2}{12} + m_1 \cdot \left[ \frac{A}{2} - S \right]^2$$

- Calculate the moment of inertia of the attachment for arm.

$$I_2 = m_2 \cdot \frac{D^2}{8} + m_2 \cdot L^2$$

<Calculation example> when the cylinder bore size is  $\phi 32$ .

A = 0.1 m      D = 0.02 m  
 B = 0.03 m    m<sub>1</sub> = 0.35 kg  
 S = 0.012 m   m<sub>2</sub> = 0.15 kg  
 L = 0.076 m

$$I_1 = 0.35 \times \frac{0.1^2 + 0.03^2}{12} + 0.35 \times \left( \frac{0.1}{2} - 0.012 \right)^2 = 8.2 \times 10^{-4} \text{ kg}\cdot\text{m}^2$$

$$I_2 = 0.15 \times \frac{0.02^2}{8} + 0.15 \times 0.076^2 = 8.7 \times 10^{-4} \text{ kg}\cdot\text{m}^2$$

- Calculate the actual moment of inertia.

$$I = I_1 + I_2 = (8.2 + 8.7) \times 10^{-4} = 1.7 \times 10^{-3} \text{ kg}\cdot\text{m}^2$$

Calculation result (when the bore size is  $\phi 32$  and clamp stroke is 10 mm.)

Model	Max. piston speed	Average piston speed <small>Note 1)</small>	Total stroke <small>Note 2)</small>	Stroke time <small>Note 3)</small>
MK	115 mm/s	72 mm/s	25 mm	0.35 seconds

Note 1) Average piston speed = Max. piston speed  $\div 1.6$

Note 2) Total stroke = Clamp stroke + Rotary stroke

Note 3) Total stroke  $\div$  Average piston speed

The stroke time should be longer than the above mentioned stroke time.

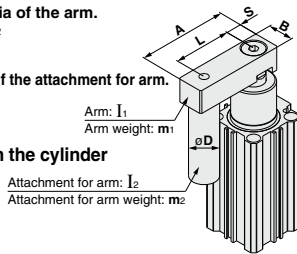

$\phi 32, \phi 40$

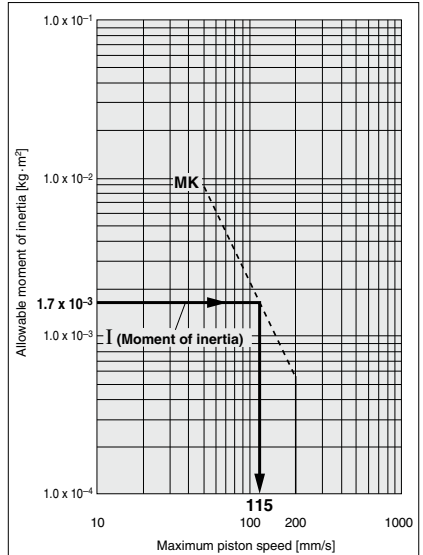

## Calculation Equation List for Moment of Inertia

I: Moment of inertia [kg·m<sup>2</sup>]    m: Load mass [kg]

If arms other than the options are used, be sure to calculate the moment of inertia of the arm before selecting it.

### 1. Thin shaft

Position of rotational axis:  
 Perpendicular to the shaft, and attached near one end

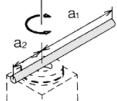

$$I = m_1 \cdot \frac{a_1^2}{3} + m_2 \cdot \frac{a_2^2}{3}$$

### 2. Thin shaft

Position of rotational axis:  
 Perpendicular to the shaft, and attached at the center of gravity

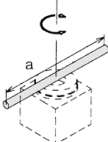

$$I = m \cdot \frac{a^2}{12}$$

### 3. Thin rectangular plate (Rectangular parallelepiped)

Position of rotational axis:  
 Parallel to side b, and attached at the center of gravity

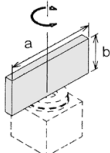

$$I = m \cdot \frac{a^2}{12}$$

### 4. Thin rectangular plate (Rectangular parallelepiped)

Position of rotational axis:  
 Perpendicular to the plate, and attached near one end

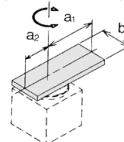

$$I = m_1 \cdot \frac{4a_1^2 + b^2}{12} + m_2 \cdot \frac{4a_2^2 + b^2}{12}$$

### 5. Thin rectangular plate (Rectangular parallelepiped)

Position of rotational axis:  
 Attached at the center of gravity, and perpendicular to the plate  
 (Same as also thick rectangular plate)

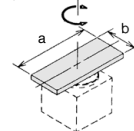

$$I = m \cdot \frac{a^2 + b^2}{12}$$

### 6. Load at the end of lever arm

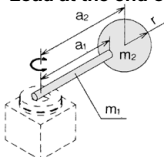

$$I = m_1 \cdot \frac{a_1^2}{3} + m_2 \cdot a_2^2 + k$$

$$k = m_2 \cdot \frac{2l^2}{5}$$

## ⚠ Caution

### 1. Do not use the cylinder under the following environments:

- An area in which fluids such as cutting oil splash on the piston rod
- An area in which foreign matter such as particles, cutting chips, or dust is present
- An area in which the ambient temperature exceeds the operating range
- An area exposed to direct sunlight
- An environment that poses the risk of corrosion

### 2. A cylinder could malfunction or the non-rotating accuracy could be affected if a rotational force is applied to the piston rod. Therefore, observe the particulars given below before operating the cylinder.

- 1) Make sure to mount the cylinder vertically (Fig. (1)).
- 2) Do not absolutely perform any work (such as clamping or acting as a stopper, etc.) in the rotary direction (Fig. (2)).
- 3) To clamp, make sure to do so within the clamp stroke (straight-line stroke) (Fig. (3)).
- 4) Make sure that the clamping surface of the workpiece is perpendicular to the cylinder's axial line (Fig. (4)).
- 5) Do not operate the cylinder in such a way that an external force causes the workpiece to move while being clamped (Fig. (5)).
- 6) Furthermore, do not operate the cylinder in an application in which a rotational force will be applied to the piston rod.

- 1) Do not operate the cylinder horizontally.  
When using the cylinder horizontally, use the MK2T series.

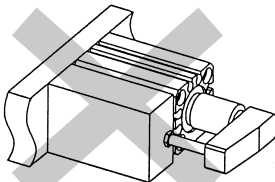

Fig. (1)

- 2) Do not perform any work in the rotary direction.

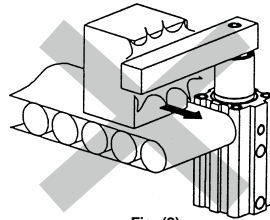

Fig. (2)

- 3) Do not clamp during the rotary stroke. Clamp should be performed within the clamp stroke.

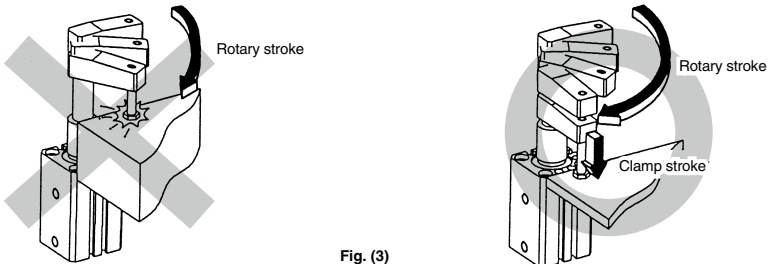

Fig. (3)

- 4) Do not clamp on a slanted surface.

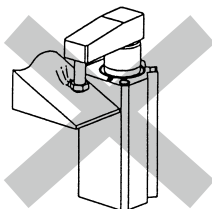

Fig. (4)

- 5) Make sure that the workpiece does not move during clamping.

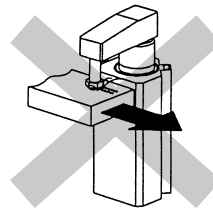

Fig. (5)

# Rotary Clamp Cylinder: Standard

# MK Series

ø12, ø16, ø20, ø25, ø32, ø40, ø50, ø63

## How to Order

**MK B 20** - **10 R N Z** - **M9BW** -

**Rotary clamp cylinder** •

**Mounting bracket** •

Symbol	Mounting
<b>B</b>	Through-hole/Both ends tapped common (Basic)
<b>F</b>	Rod flange
<b>G</b>	Head flange

\* Rod flange, head flanges are shipped together, (but not assembled).

**Bore size** •

12	12 mm
16	16 mm
20	20 mm
25	25 mm
32	32 mm
40	40 mm
50	50 mm
63	63 mm

**Port thread type** •

Nil	M thread	ø12 to ø25
	Rc	
TN	NPT	ø32 to ø63
	G	

**Clamp stroke** •

Symbol	Clamp stroke	Applicable bore size
<b>10</b>	10 mm	ø12 to ø63
<b>20</b>	20 mm	
<b>30</b>	30 mm	
<b>50</b>	50 mm	ø32 to ø63

**Auto switch type**

<b>Nil</b>	2 pcs.
<b>S</b>	1 pc.

**Auto switch type**

<b>Nil</b>	Without auto switch (Built-in magnet)
------------	---------------------------------------

**Auto switch multiple side mounting**

**Body option**

<b>Nil</b>	Standard (Female thread)
<b>N</b>	With arm

\* Arms are shipped together, (but not assembled).

**Rotary direction (Unclamp → Clamp)**

<b>R</b>	Clockwise
<b>L</b>	Counterclockwise

During unclamping (Extension end)  
L type (Counterclockwise)

During unclamping (Extension end)  
R type (Clockwise)

During clamping (Retraction end)

## Applicable Auto Switches/Refer to pages 1341 to 1435 for further information on auto switches.

Type	Special function	Electrical entry	Indicator/light	Wiring (Output)	Load voltage		Auto switch model		Lead wire length (m)					Pre-wired connector	Applicable load						
					DC	AC	Perpendicular	In-line	0.5 (Nil)	1 (M)	3 (L)	5 (Z)	None (N)								
Solid state auto switch	—	Grommet	Yes	3-wire (NPN)	24 V	—	M9NV	M9N	●	●	●	○	—	○	IC circuit	Relay, PLC					
				3-wire (PNP)					5 V, 12 V	M9PV	M9P	●	●	●			○	—	○		
				2-wire					12 V	M9BV	M9B	●	●	●			○	—	○		
	3-wire (NPN)			24 V	—	M9NVV	M9NW	●	●	●	○	—	○	IC circuit							
	3-wire (PNP)							5 V, 12 V	M9PVV	M9PW	●	●	●		○		—	○			
	2-wire							12 V	M9BVV	M9BW	●	●	●		○		—	○			
	Water resistant (2-color indicator)			Grommet	Yes	3-wire (NPN)	24 V	—	M9NAV*1	M9NA*1	○	○	●	○	—		○	IC circuit			
						3-wire (PNP)					5 V, 12 V	M9PAV*1	M9PA*1	○	○		●		○	—	○
						2-wire					12 V	M9BAV*1	M9BA*1	○	○		●		○	—	○
Magnetic field resistant (2-color indicator)	Grommet	Yes	2-wire (Non-polar)	—	—	—	P3DWA*	●	—	●	●	—	●	—							
Reed auto switch	—	Grommet	No	3-wire (NPN equivalent)	—	5 V	—	A96V	A96	●	—	—	—	—	IC circuit	—					
				2-wire	12 V	100 V	A93V*2	A93	●	●	●	●	—	—	—	Relay, PLC					
					24 V	5 V, 12 V	100 V or less	A90V	A90	●	—	●	—	—	—	IC circuit					

\*1 Water resistant type auto switches can be mounted on the above models, but in such case SMC cannot guarantee water resistance. Consult with SMC regarding water resistant types with the above model numbers.

\*2 1 m type lead wire is only applicable to D-A93.

\* Lead wire length symbols: 0.5 m ..... Nil (Example) M9NW  
 1 m ..... M (Example) M9NWM  
 3 m ..... L (Example) M9NWL  
 5 m ..... Z (Example) M9NZW

\* Solid state auto switches marked with "○" are produced upon receipt of order.  
 \* For D-P3DWA□, ø32 to ø63 are available.

\* Since there are other applicable auto switches than listed, refer to page 414 for details.  
 \* For details about auto switches with pre-wired connector, refer to pages 1410 and 1411.  
 \* Auto switches are shipped together, (but not assembled).



## Symbol

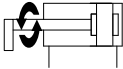

## Rotary Angle

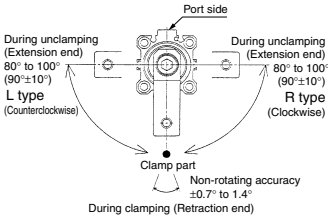

**Made to Order: Individual Specifications**  
 (For details, refer to pages 415 and 417.)

Symbol	Description
-X2071	Max. operating pressure 1.0 MPa
-X2094	Overall length is the same as the previous MK2 series
-X2172	With boss in head end
-X2177	The dimension of head end flange is the same as the previous series MK and MK2
-X2997	Rotary angle 60° specifications

## Made to Order Specifications

(For details, refer to pages 1471 to 1637.)

Symbol	Description
-XB6	Heat resistant cylinder (-10 to 150°C) w/o auto switch only (Note 1)
-XC4	With heavy duty scraper (Note 2)
-XC22	Fluororubber seals (Note 3)

Note 1) Except ø12 and ø16.

Note 2) Applicable to ø16 to ø63 (Rod flange type only applicable to ø32 to ø63)

Note 3) The bumper is a standard product.

For details on the water-resistant cylinder and the series compatible with secondary batteries (25A-), refer to the **Web Catalog**.

## Specifications

Bore size (mm)	12	16	20	25	32	40	50	63
<b>Action</b>	Double acting							
<b>Rotary angle</b> (Note 1)	90° ±10°							
<b>Rotary direction</b> (Note 2)	Clockwise, Counterclockwise							
<b>Rotary stroke (mm)</b>	7.5		9.5		15		19	
<b>Clamp stroke (mm)</b>	10, 20, 30		10, 20, 30, 50		10, 20, 30, 50		19	
<b>Theoretical clamp force (N)</b> (Note 3)	40	75	100	185	300	525	825	1400
<b>Fluid</b>	Air							
<b>Proof pressure</b>	1.5 MPa							
<b>Operating pressure range</b>	0.1 to 1 MPa							
<b>Ambient and fluid temperature</b>	Without auto switch: -10 to 70°C (No freezing) With auto switch: -10 to 60°C (No freezing)							
<b>Lubrication</b>	Non-lube							
<b>Piping port size</b>	M5 x 0.8		Rc1/8, NPT1/8 G1/8		Rc1/4, NPT1/4 G1/4			
<b>Mounting</b>	Through-hole/Both ends tapped common, Head flange, Rod flange							
<b>Cushion</b>	Rubber bumper							
<b>Stroke length tolerance</b>	+0.6 -0.4							
<b>Piston speed</b> (Note 5)	50 to 200 mm/s							
<b>Non-rotating accuracy (Clamp part)</b> (Note 1)	±1.4°		±1.2°		±0.9°		±0.7°	

Note 1) Refer to Rotary Angle figure.

Note 2) Direction of rotation viewed from the rod end when the piston rod is retracting

Note 3) Clamp force at 0.5 MPa

Note 4) When using the cylinder within a pressure range from 0.61 to 1 MPa, please use -X2071.

Note 5) Be sure to install a speed controller to the cylinder, and adjust the cylinder speed to make it within the range from 50 to 200 mm/s. To adjust the speed, start with the needle in the completely closed position, and then adjust it by opening gradually.

## Theoretical Output

Bore size (mm)	Rod size (mm)	Operating direction	Piston area (cm <sup>2</sup> )	Operating pressure (MPa)			
				0.3	0.5	0.7	1.0
12	6	IN	0.8	25	42	59	85
		OUT	1.1	34	57	79	113
16	8	IN	1.5	45	75	106	151
		OUT	2.0	60	101	141	201
20	12	IN	2.0	60	101	141	201
		OUT	3.1	94	157	220	314
25	12	IN	3.8	113	189	264	378
		OUT	4.9	147	245	344	491
32	16	IN	6.0	181	302	422	603
		OUT	8.0	241	402	563	804
40	16	IN	10.6	317	528	739	1056
		OUT	12.6	377	628	880	1257
50	20	IN	16.5	495	825	1155	1649
		OUT	19.6	589	982	1374	1963
63	20	IN	28.0	841	1402	—	—
		OUT	31.2	935	1559	—	—

Note) Theoretical output (N) = Pressure (MPa) x Piston area (cm<sup>2</sup>) x 100

Operating direction IN: Clamp OUT: Unclamp

## Option/Arm

Bore size (mm)	Part no.	Accessories
12	MK-A012Z	Clamp bolt, Hexagon socket head cap screw, Hexagon nut, Spring washer
16	MK-A016Z	
20	MK-A020Z	
25	MK-A025Z	
32	MK-A032Z	
40	MK-A040Z	
50	MK-A050Z	
63	MK-A063Z	

## Mounting Bracket/Flange

Bore size (mm)	Rod flange	Head flange	Accessories
12	MKZ-RF012	CQS-F012	Special hexagon socket head cap screw (4 pcs.)
16	MKZ-RF016	CQS-F016	
20	MKZ-RF020	MKZ-F020	
25	MKZ-RF025	MKZ-F025	Special hexagon socket head cap screw (2 pcs.)
32	MKZ-RF032	MKZ-F032	
40	MKZ-RF040	MKZ-F040	Special hexagon socket head cap screw (4 pcs.)
50	MKZ-RF050	MKZ-F050	
63	MKZ-RF063	MK2T-F063	
		MK2T-F063	



## Weight

Clamp stroke (mm)	Bore size (mm)							
	12	16	20	25	32	40	50	63
10	69	94	222	282	445	517	921	1256
20	84	113	250	319	494	570	1001	1364
30	99	132	279	355	542	623	1081	1472
50	—	—	—	—	639	728	1241	1687

Unit: g

## Additional Weight

Bore size (mm)	12	16	20	25	32	40	50	63
With arm	13	32	100	100	200	200	350	350
Rod flange (including mounting bolt)	56	65	123	135	155	203	363	518
Head flange (including mounting bolt)	58	69	130	150	175	209	371	578

Unit: g

Calculation: (Example) **MKG20-10RNZ**

- Standard calculation: MKB20-10RZ...222 g
- Extra weight calculation: Head flange .....130 g  
With arm .....100 g  
452 g

## Mounting Bolt for MKB-Z

Mounting: Mounting bolt for through-hole type is available.

Refer to the following for ordering procedures.

Order the actual number of bolts that will be used.

**Example) CQ-M3x50L 4 pcs.**

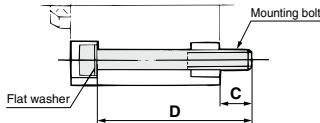

Note) Be sure to use a flat washer to mount cylinders via through-holes.

Cylinder model	C	D	Mounting bolt part no.
<b>MKB12-10□Z</b>	8	50	CQ-M3 x 50L
-20□Z		60	x 60L
-30□Z		70	x 70L
<b>MKB16-10□Z</b>	8	50	CQ-M3 x 50L
-20□Z		60	x 60L
-30□Z		70	x 70L
<b>MKB20-10□Z</b>	9	75	CQ-M5 x 75L
-20□Z		85	x 85L
-30□Z		95	x 95L
<b>MKB25-10□Z</b>	8	75	CQ-M5 x 75L
-20□Z		85	x 85L
-30□Z		95	x 95L
<b>MKB32-10□Z</b>	9.5	85	CQ-M5 x 85L
-20□Z		95	x 95L
-30□Z		105	x 105L
-50□Z		125	x 125L
<b>MKB40-10□Z</b>	11	80	CQ-M5 x 80L
-20□Z		90	x 90L
-30□Z		100	x 100L
-50□Z		120	x 120L
<b>MKB50-10□Z</b>	10.5	90	CQ-M6 x 90L
-20□Z		100	x 100L
-30□Z		110	x 110L
-50□Z		130	x 130L
<b>MKB63-10□Z</b>	14.1	95	CQ-M8 x 95L
-20□Z		105	x 105L
-30□Z		115	x 115L
-50□Z		135	x 135L

## Clamp Arm Mounting

### ⚠ Caution

Use a clamp arm that is available as an option.

To fabricate a clamp arm, make sure that the allowable bending moment and the inertial moment will be within the specified range. Refer to Graph 1 and 2 on page 399.

## Ensuring Safety

### ⚠ Caution

If one side of the piston is pressurized by supplying air with the clamp arm attached, the piston will move vertically while the clamp arm rotates.

This operation could be hazardous to personnel, as their hands or feet could get caught by the clamp arm, or could lead to equipment damage. Therefore, it is important to secure as a danger zone a cylindrical area with the length of the clamp arm as its radius, and the stroke plus 20 mm as its height.

## Clamp Arm Mounting and Removal

### ⚠ Caution

When the arm is mounted onto or removed from the piston rod, do not fix the cylinder body, but hold the arm with a spanner when tightening or loosening the bolt (Fig. 1).

If the bolt is tightened with the cylinder body fixed, excessive rotation force will be applied to the piston rod, which may damage the internal components.

Note that when making an arm, machine it so that it engages with the width across flats on the rod end to prevent it from rotating.

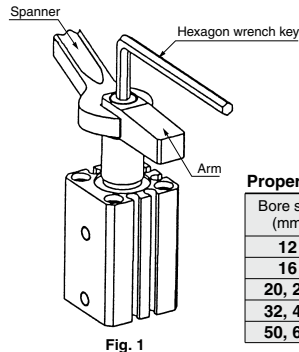

Fig. 1

### Proper Tightening Torque

Bore size (mm)	Proper tightening torque (N·m)
<b>12</b>	0.5 to 0.7
<b>16</b>	2.8 to 3.5
<b>20, 25</b>	11.5 to 14.0
<b>32, 40</b>	24 to 30
<b>50, 63</b>	75 to 90

## Flange Mounting

### ⚠ Caution

The mounting bolt for the rod flange or head flange should be tightened to the torque shown in the table below.

Bore size	Thread size	Tightening torque
ø12, 16	M4 x 0.7	1.4 to 2.6 N·m
ø20 to 40	M6 x 1.0	9.0 to 12.0 N·m
ø50	M8 x 1.25	11.4 to 22.4 N·m
ø63	M10 x 1.5	25.0 to 44.9 N·m

# MK Series

## Construction

### New MK12, 16

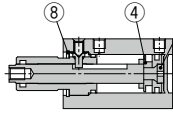

### New MK20 to 32

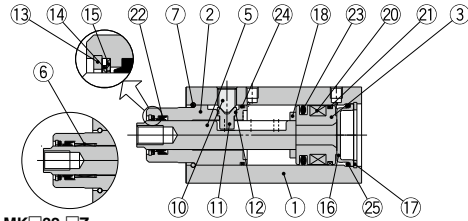

MK□32-□Z

### New MK40 to 63

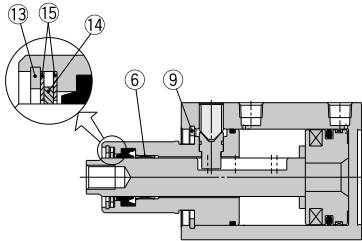

### With arm (N)

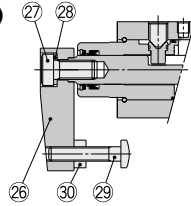

### Rod flange (F)

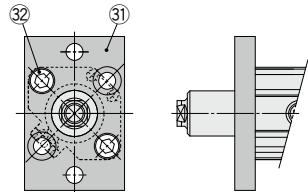

### Head flange (G)

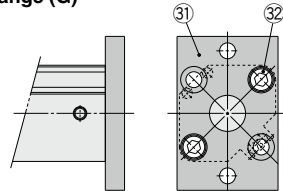

## Component Parts

No.	Description	Material	Note
1	Cylinder tube	Aluminum alloy	Hard anodized
2	Rod cover	Aluminum alloy	Hard anodized
3	Piston	Aluminum alloy	
4	Magnet holder	Aluminum alloy	
5	Piston rod	Stainless steel	ø12 to ø25 Nitriding
5		Carbon steel	ø32 to ø63 Heated, Nickel plated
6	Bushing	Copper bearing material	ø32 to ø63 only
7	Stop ring	Stainless steel	ø20 to ø32 only
8	Round R-type retaining ring	Carbon tool steel	ø12, ø16 only
9	C-type retaining ring	Carbon tool steel	ø40 to ø63 only
10	Hexagon socket head set screw	Chromium molybdenum steel	Sharp end section: 90°
11	Guide pin	Stainless steel	Nitriding
12	O-ring	NBR	
13	Round R-type retaining ring	Carbon tool steel	Except ø12, ø16
14	Coil scraper	Phosphor bronze	Except ø12, ø16
15	Scraper pressure	Stainless steel	Except ø12, ø16
16	Head cover	Rolled steel	Electroless nickel plated
17	C-type retaining ring	Carbon tool steel	ø20 to ø32 only

## Component Parts

No.	Description	Material	Note
18	Bumper	Urethane	
19	Bumper B	Urethane	ø12, ø16 only
20	Magnet	—	
21	Wear ring	Resin	Except ø12, ø16
22	Rod seal	NBR	
23	Piston seal	NBR	
24	Gasket	NBR	
25	O-ring	NBR	ø20 to ø32 only
26	Arm	Rolled steel	
27	Hexagon socket head cap screw	Chromium molybdenum steel	
28	Spring washer	Hard steel	
29	Clamp bolt	Chromium molybdenum steel	
30	Hexagon nut	Rolled steel	
31	Flange	Rolled steel	Rod flange is not compatible with the head flange.
32	Hexagon socket head cap screw	Chromium molybdenum steel	Qty. ø12, ø16, ø32 to ø40: 4 pcs. ø20, ø25: 2 pcs.

## Replacement Parts/Seal Kit

Bore size (mm)	ø12	ø16	ø20	ø25	ø32	ø40	ø50	ø63
Kit no.	CQSB12-PS	CQSB16-PS	MK20Z-PS	MK25Z-PS	MK32Z-PS	MK2T40-PS	MK2T50-PS	MK63Z-PS
Contents	Set of nos. above 22 23 24			Set of nos. above 14 22 23 24 25		Set of nos. above 14 22 23 24		

\* Seal kit includes numbers in the table. Order the seal kit, based on each bore size.

\* Since the seal kit does not include a grease pack, order it separately. Grease pack part no.: GR-S-010 (10 g)

## Replacement Parts/Guide Pin Kit

Bore size (mm)	ø12	ø16	ø20	ø25	ø32	ø40	ø50	ø63
Kit no.	MK12Z-GS	MK16Z-GS	MK20Z-GS	MK25Z-GS	MK32Z-GS	MK40Z-GS	MK50Z-GS	MK63Z-GS
Contents	Set of nos. above 10 11 12							

\* Guide pin kit includes numbers in the table. Order the guide pin kit, based on each bore size.

\* For the replacement procedure of the replacement parts/seal and guide pin kits, refer to the Operation Manual.

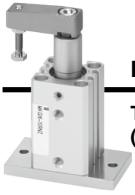

## Dimensions: $\varnothing 12, \varnothing 16$

The outline dimensions shown are when the rod is retracted.

### Through-hole/Both ends tapped common (Basic)

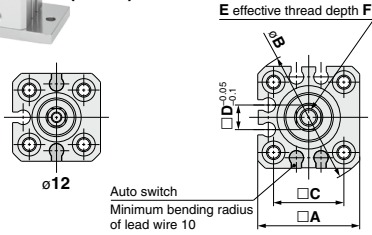

Auto switch  
Minimum bending radius  
of lead wire 10

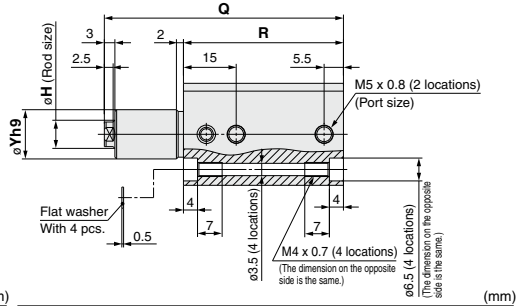

### Basic (mm)

Model	A	B	C	D	E	F	H	$\varnothing Yh9$
<b>MKB12-Z</b>	25	32	15.5	5	M3 x 0.5	5.5	6	11 <sub>-0.043</sub>
<b>MKB16-Z</b>	29	38	20	7	M5 x 0.8	6.5	8	14 <sub>-0.043</sub>

Model	Rod state	Clamp stroke (mm)					
		10 mm		20 mm		30 mm	
		Q	R	Q	R	Q	R
<b>MKB12-Z</b>	Retracted	68	45.5	88	55.5	108	65.5
	Extended	85.5		115.5		145.5	
<b>MKB16-Z</b>	Retracted	68	45.5	88	55.5	108	65.5
	Extended	85.5		115.5		145.5	

### With arm

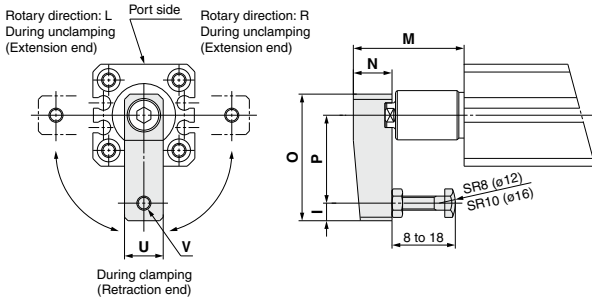

Rotary direction: L  
During unclamping  
(Extension end)

Rotary direction: R  
During unclamping  
(Extension end)

During clamping  
(Retraction end)

### With Arm (mm)

Model	I	N	O	P	U	V
<b>MKB12-Z</b>	4	8	29	20	8	M3 x 0.5
<b>MKB16-Z</b>	5	11	36	25	11	M4 x 0.7

Model	Rod state	M (mm)		
		10 mm	20 mm	30 mm
<b>MKB12-Z</b>	Retracted	28.5	38.5	48.5
	Extended	46	66	86
<b>MKB16-Z</b>	Retracted	31.5	41.5	51.5
	Extended	49	69	89

### Head flange

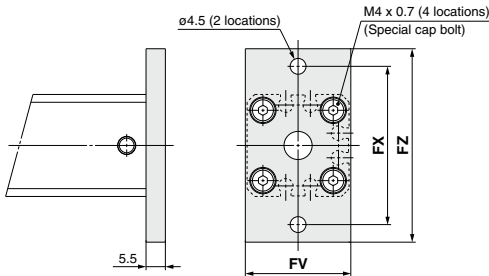

### Head Flange (mm)

Model	FV	FX	FZ
<b>MKG12-Z</b>	25	45	55
<b>MKG16-Z</b>	30	45	55

### Rod flange

- \* The dimensions other than MM dimensions are the same as those of head flange.
- \* The arm dimensions other than M dimensions are the same as those of with arm.

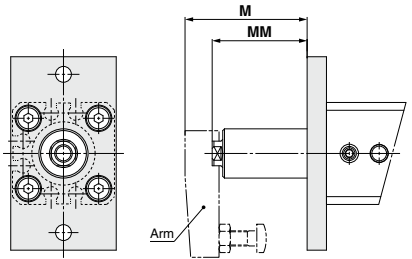

### Rod Flange (mm)

Model	Rod state	M (mm)			MM (mm)		
		10 mm	20 mm	30 mm	10 mm	20 mm	30 mm
<b>MKF12-Z</b>	Retracted	23	33	43	17	27	37
	Extended	40.5	60.5	80.5	34.5	54.5	74.5
<b>MKF16-Z</b>	Retracted	26	36	46	17	27	37
	Extended	43.5	63.5	83.5	34.5	54.5	74.5

# MK Series



Dimensions:  $\varnothing 20$ ,  $\varnothing 25$

The outline dimensions shown are when the rod is retracted.

## Through-hole/Both ends tapped common (Basic)

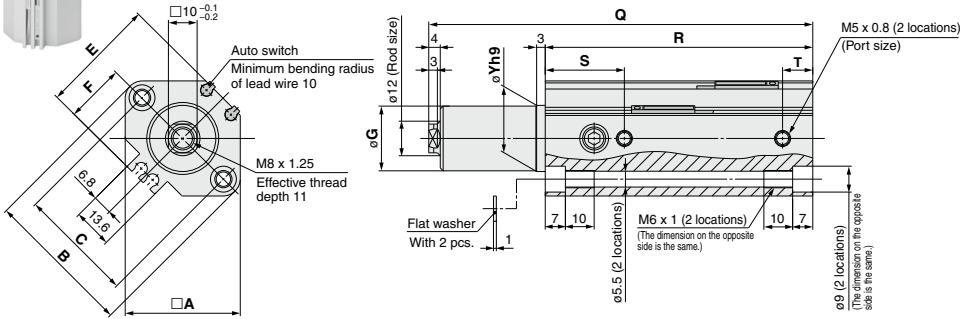

Basic (mm)								
Model	A	B	C	E	F	G	$\varnothing Yh9$	T
MKB20-Z	36	47	36	35.5	18	17.9	$18_{-0.043}^0$	28
MKB25-Z	40	52	40	40.5	21	22.5	$23_{-0.052}^0$	27.5

Model	Rod state	Clamp stroke (mm)					
		10 mm		20 mm		30 mm	
		Q	R	Q	R	Q	R
MKB20-Z	Retracted	92.5	72	112.5	82	132.5	92
	Extended	112	142			172	
MKB25-Z	Retracted	93.5	73	113.5	83	133.5	93
	Extended	113	143			173	

## With arm

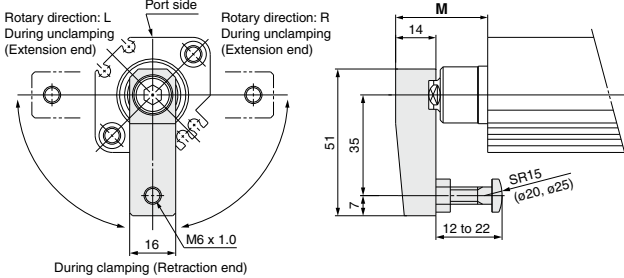

(Note) The above figure is with the auto switch (D-M9□) mounted.

## With Arm

Model	Rod state	M (mm)		
		Clamp stroke		
		10 mm	20 mm	30 mm
MKB20-Z	Retracted	32	42	52
	Extended	51.5	71.5	91.5
MKB25-Z	Retracted	32	42	52
	Extended	51.5	71.5	91.5

## Head flange

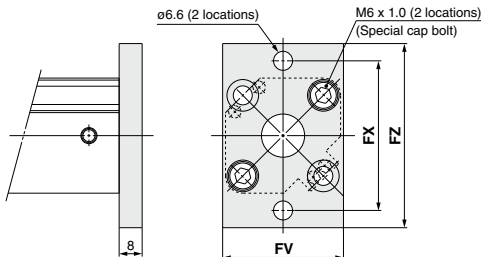

Head Flange (mm)			
Model	FV	FX	FZ
MKG20-Z	39	48	60
MKG25-Z	42	52	64

## Rod flange

\* The dimensions other than MM dimensions are the same as those of head flange.  
\* The arm dimensions other than M dimensions are the same as those of with arm.

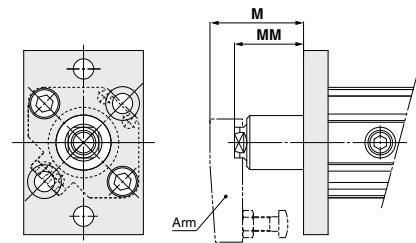

## Rod Flange

Model	Rod state	M (mm)			MM (mm)		
		Clamp stroke			Clamp stroke		
		10 mm	20 mm	30 mm	10 mm	20 mm	30 mm
MKF20-Z	Retracted	24	34	44	12.5	22.5	32.5
	Extended	43.5	63.5	83.5	32	52	72
MKF25-Z	Retracted	24	34	44	12.5	22.5	32.5
	Extended	43.5	63.5	83.5	32	52	72



## Dimensions: $\varnothing 32$ , $\varnothing 40$ , $\varnothing 50$ , $\varnothing 63$

The outline dimensions shown are when the rod is retracted.

### Through-hole/Both ends tapped common (Basic)

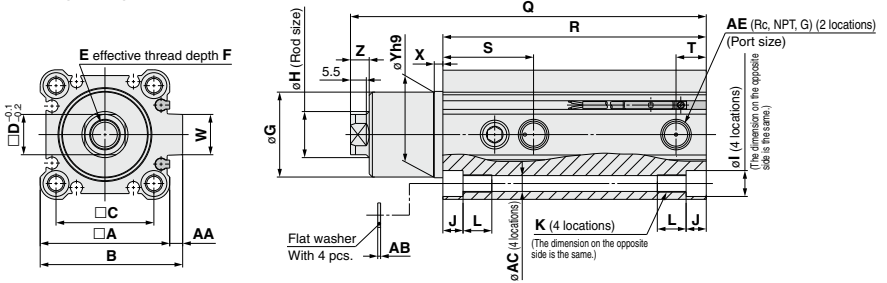

### Basic

Model	A	B	C	D	E	F	G	H	I	J	K	L	S	T	W	X	$\varnothing Y_{H9}$	Z	AA	AB	$\varnothing AC$	AE
<b>MKB32-Z</b>	45	49.5	34	14	M10 x 1.5	12	29.5	16	9	7	M6 x 1.0	10	31.5	10.5	14	3	$30_{-0.062}^0$	6.5	4.5	1	5.5	1/8
<b>MKB40-Z</b>	52	57	40	14	M10 x 1.5	12	29.5	16	9	7	M6 x 1.0	10	29	9	15	3	$30_{-0.062}^0$	6.5	5	1	5.5	1/4
<b>MKB50-Z</b>	64	71	50	17	M12 x 1.75	15	36.5	20	11	8	M8 x 1.25	14	34	11.5	19	3.5	$37_{-0.062}^0$	7.5	7	1	6.6	1/4
<b>MKB63-Z</b>	77	84	60	17	M12 x 1.75	15	47.5	20	14	10.5	M10 x 1.5	18	34.5	10.5	19	3.5	$48_{-0.062}^0$	7.5	7	1.4	9	1/4

Model	Rod state	Clamp stroke							
		10 mm		20 mm		30 mm		50 mm	
		Q	R	Q	R	Q	R	Q	R
<b>MKB32-Z</b>	Retracted	113.5	81.5	133.5	91.5	153.5	101.5	193.5	121.5
	Extended	138.5		168.5		198.5		258.5	
<b>MKB40-Z</b>	Retracted	114.5	75	134.5	85	154.5	95	194.5	115
	Extended	139.5		169.5		199.5		259.5	
<b>MKB50-Z</b>	Retracted	132	86.5	152	96.5	172	106.5	212	126.5
	Extended	161		191		221		281	
<b>MKB63-Z</b>	Retracted	135	90	155	100	175	110	215	130
	Extended	164		194		224		284	

Note) The above figure is with the auto switch (D-M9□) mounted.

### With arm

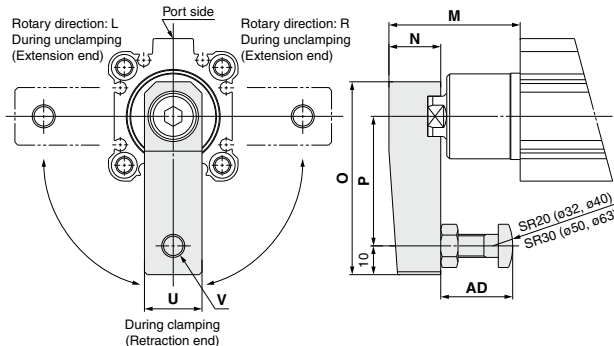

### With Arm

Model	N	O	P	U	V	AD
<b>MKB32-Z</b>	18	67	45	20	M8 x 1.25	15 to 25
<b>MKB40-Z</b>	18	67	45	20	M8 x 1.25	15 to 25
<b>MKB50-Z</b>	22	88	65	22	M10 x 1.5	30 to 40
<b>MKB63-Z</b>	22	88	65	22	M10 x 1.5	30 to 40

Model	Rod state	Clamp stroke			
		M			
		10 mm	20 mm	30 mm	50 mm
<b>MKB32-Z</b>	Retracted	45.5	55.5	65.5	85.5
	Extended	70.5	90.5	110.5	150.5
<b>MKB40-Z</b>	Retracted	53	63	73	93
	Extended	78	98	118	158
<b>MKB50-Z</b>	Retracted	63	73	83	103
	Extended	92	112	132	172
<b>MKB63-Z</b>	Retracted	62.5	72.5	82.5	102.5
	Extended	91.5	111.5	131.5	171.5

# MK Series



Dimensions:  $\varnothing 32$ ,  $\varnothing 40$ ,  $\varnothing 50$ ,  $\varnothing 63$

The outline dimensions shown are when the rod is retracted.

## Head flange

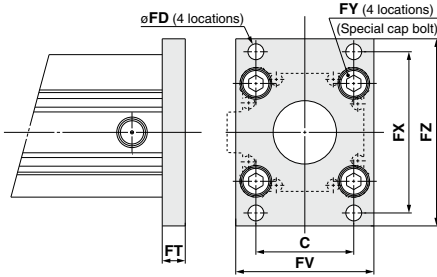

### Head Flange

(mm)

Model	C	$\varnothing$ FD	FT	FV	FX	FY	FZ
<b>MKG32-Z</b>	34	5.5	8	48	56	M6 x 1.0	65
<b>MKG40-Z</b>	40	5.5	8	54	62	M6 x 1.0	72
<b>MKG50-Z</b>	50	6.6	9	67	76	M8 x 1.25	89
<b>MKG63-Z</b>	60	9	9	80	92	M10 x 1.5	108

## Rod flange

- \* The dimensions other than MM dimensions are the same as those of head flange.
- \* The arm dimensions other than M dimensions are the same as those of with arm.

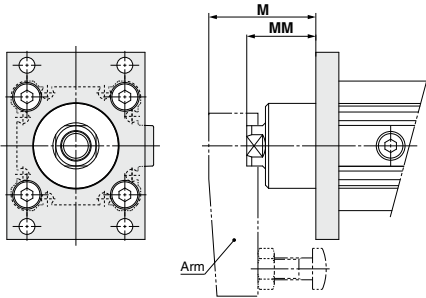

### Rod flange

(mm)

Model	Rod state	M				MM			
		Clamp stroke				Clamp stroke			
		10 mm	20 mm	30 mm	50 mm	10 mm	20 mm	30 mm	50 mm
<b>MKF32-Z</b>	Retracted	37.5	47.5	57.5	77.5	24	34	44	64
	Extended	62.5	82.5	102.5	142.5	49	69	89	129
<b>MKF40-Z</b>	Retracted	45	55	65	85	31.5	41.5	51.5	71.5
	Extended	70	90	110	150	56.5	76.5	96.5	136.5
<b>MKF50-Z</b>	Retracted	54	64	74	94	36.5	46.5	56.5	76.5
	Extended	83	103	123	163	65.5	85.5	105.5	145.5
<b>MKF63-Z</b>	Retracted	53.5	63.5	73.5	93.5	36	46	56	76
	Extended	82.5	102.5	122.5	162.5	65	85	105	145

# Auto Switch Mounting

## Auto Switch Proper Mounting Position (Detection at Stroke End) and its Mounting Height

ø12

D-M9□  
D-M9□W  
D-M9□A  
D-A9□

D-M9□V  
D-M9□WV  
D-M9□AV  
D-A9□V

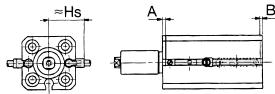

When mounted

a)

b)

ø16

When mounted

a)

b)

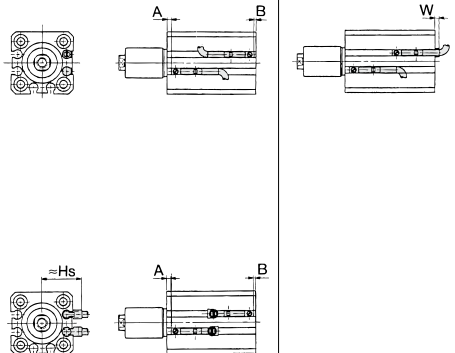

### Auto Switch Proper Mounting Position

(mm)

Bore size (mm)	D-M9□ D-M9□W D-M9□AV			D-M9□V D-M9□WV			D-M9□A			D-A9□ D-A9□V		
	A	B	W	A	B	W	A	B	W	A	B	W
12	12	4	6	12	4	4	12	4	8	8	0	4.5 (2)
16	12	4	6	12	4	4	12	4	8	8	0	4.5 (2)

Note 1) ( ): D-A96, A9□V

Note 2) When setting an auto switch, confirm the operation and adjust its mounting position.

### Auto Switch Mounting Height

(mm)

Auto switch model	D-M9□V D-M9□WV D-M9□AV		D-A9□V
	Hs		Hs
Bore size	Hs		Hs
12	19		17
16	21		19

### Operating Range

(mm)

Auto switch model	Bore size							
	12	16	20	25	32	40	50	63
D-M9□/M9□V D-M9□W/M9□WV D-M9□A/M9□AV	3	4	5	5.5	5	5	5	6.5
D-A9□/A9□V	6	7.5	10	9	9	9.5	9.5	11
D-F7□/J79 D-F7□V/J79C D-F7□W/F7□WV D-J79W D-F79F/F7BA D-F7BAV/F7NT	—	—	6	6	6	6.5	6.5	7.5
D-A7□/A80 D-A7□H/A80H D-A73C/A80C	—	—	12	11	10.5	11.5	11	13
D-A79W	—	—	15.5	14	14	15.5	14.5	17
D-P3DWA	—	—	—	—	6	5.5	6	7

\* Since this is a guideline including hysteresis, not meant to be guaranteed (assuming approximately ±30% dispersion).

There may be the case it will vary substantially depending on the ambient environment.

\* The D-M9□(V), M9□W(V), M9□A(V), and A9□(V) with ø12 or ø16 (MK), or ø32 or more (MK, MK2) indicate the operating range when using the current auto switch mounting groove, without using auto switch mounting bracket BQ2-012.

# MK Series

## Auto Switch Proper Mounting Position (Detection at Stroke End) and its Mounting Height

D-M9□  
D-M9□V  
D-M9□W  
D-M9□WV

D-M9□A  
D-M9□AV  
D-A9□  
D-A9□V

ø20, ø25

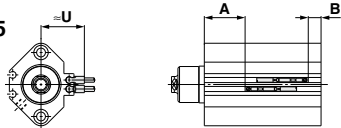

ø32 to ø63

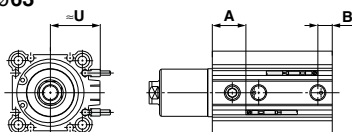

D-F7□/J79  
D-F7□V  
D-J79C  
D-F7□W/J79W  
D-F7□WV  
D-F7BA/F7BAV

D-F79F/F7NT  
D-A7□/A80  
D-A73C/A80C  
D-A7□H/A80H  
D-A79W

ø20, ø25

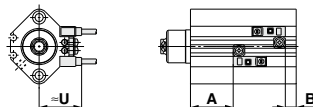

ø32 to ø63

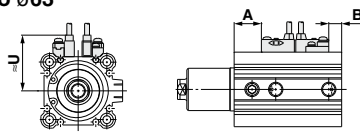

D-P3DWA  
ø32 to ø63

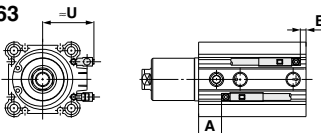

### Auto Switch Proper Mounting Position

Bore size (mm)	D-M9□ D-M9□V D-M9□W D-M9□WV D-M9□A D-M9□AV		D-F7□/J79 D-F7□V D-J79C/F7□W D-F7□WV D-F7BA D-F7BAV D-F79F/J79W D-A7□H/A80H D-A73C/A80C D-A72		D-F7NT		D-A9□ D-A9□V		D-A73 D-A80		D-A79W		D-P3DWA	
	A	B	A	B	A	B	A	B	A	B	A	B	A	B
20	30.5	10.0	28.0	7.5	33.0	12.5	26.5	6.0	27.5	7.0	25.0	4.5	—	—
25	29.5	12.0	27.0	9.5	32.0	14.5	25.5	8.0	26.5	9.0	24.0	6.5	—	—
32	31.5	13.0	29.0	10.5	34.0	15.5	27.5	9.0	28.5	10.0	26.0	7.5	27	8.5
40	25.0	13.0	22.5	10.5	27.5	15.5	21.0	9.0	22.0	10.0	19.5	7.5	20.5	8.5
50	29.0	16.5	26.5	14.0	31.5	19.0	25.0	12.5	26.0	13.5	23.5	11.0	24.5	12
63	29.5	19.5	27.0	17.0	32.0	22.0	25.5	15.5	26.5	16.5	24.0	14.0	25	15

Note) When setting an auto switch, confirm the operation and adjust its mounting position.



### Auto Switch Mounting Height

(mm)

Auto switch model	D-M9□V	D-A9□V	D-F7□/J79 D-F7□W D-J79W D-F7BA D-F79F D-F7NT D-A7□H D-A80H	D-F7□V D-F7□WV	D-J79C	D-A7□ D-A80	D-A73C D-A80C	D-A79W	D-P3DWA
Bore size	U	U	U	U	U	U	U	U	U
20	25	23	25.5	27.5	30	24.5	31	28	—
25	28	26	28	30.5	32.5	27.5	34	31	—
32	28.5	26.5	36	26.5	39.5	34	40.5	37.5	35.5
40	32	30	38	40	42.5	37.5	43.5	40.5	38
50	37.5	35	43.5	45	48	43	49	46	43
63	42.5	40.5	48.5	50.5	53.5	48	54.5	51.5	48

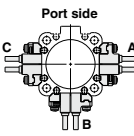

**Auto Switch Mounting Bracket/Parts No.**

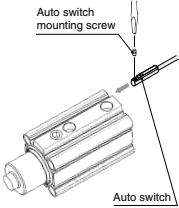
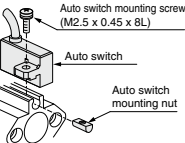
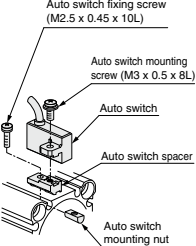
Applicable auto switch	D-M9□/M9□V D-M9□W/M9□VV D-M9□A/M9□AV D-A9□/A9□V	D-F7□/F7□V/J79/J79C/F7□W/J79W/F7□VW D-F7BA/F7BAV/F79F/F7NT D-A7□/A80/A7□H/A80H/A73C/A80C/A79W	D-P3DWA											
Bore size (mm)	ø12 to ø63	ø20, ø25	ø32 to ø63											
Auto switch mounting bracket part no.	—	BQ4-012	BQ5-032											
Auto switch mounting bracket fitting parts lineup/weight	—	<ul style="list-style-type: none"> <li>Auto switch mounting screw (M2.5 x 8L)</li> <li>Auto switch mounting nut</li> <li>Weight: 1.5 g</li> </ul>	<ul style="list-style-type: none"> <li>Auto switch fixing screw (M2.5 x 10L)</li> <li>Auto switch mounting screw (M3 x 8L)</li> <li>Auto switch spacer</li> <li>Auto switch mounting nut</li> <li>Weight: 3.5 g</li> </ul>											
		When requesting the enclosure of the auto switch mounting bracket with the cylinder for shipment, add "BQ" to the end of the cylinder part number. Standard model no. +BQ Example: MKB20-10LZ-BQ												
Auto switch mounting surface	Surfaces with auto switch mounting slot ø12, ø16 ø20, ø25	Auto switch mounting rail side only	A/B/C side except port side	Surfaces with auto switch mounting slot										
	ø32 to ø63	ø20, ø25												
Mounting of auto switch	 <p>Auto switch mounting screw</p> <p>Auto switch</p>	<ol style="list-style-type: none"> <li>Insert the nut into the auto switch mounting slot on the cylinder tube, and place it in the roughly estimated setting position.</li> <li>Engage the ridge on the auto switch mounting arm with the recess in the cylinder tube rail, and slide it to the position of the nut.</li> <li>Gently screw the auto switch mounting screw into the thread of the auto switch mounting nut through the mounting hole on the auto switch mounting arm.</li> <li>Confirm where the mounting position is, and tighten the auto switch mounting screw to fix the auto switch. The tightening torque of the M2.5 screw must be 0.25 to 0.35 N·m.</li> <li>The detection position can be changed under the conditions in step ③.</li> </ol>	<ol style="list-style-type: none"> <li>Insert the nut into the auto switch mounting slot on the cylinder tube, and place it in the roughly estimated setting position.</li> <li>With the lower tapered part of the auto switch spacer facing the outside of the cylinder tube, line up the M2.5 through hole with the M2.5 female of the auto switch mounting nut.</li> <li>Gently screw the auto switch mounting nut fixing screw (M2.5) into the thread of the auto switch mounting nut through the mounting hole.</li> <li>Engage the ridge on the auto switch mounting arm with the recess in the auto switch spacer.</li> <li>Tighten the auto switch mounting screw (M3) to fix the auto switch. The tightening torque of the M3 screw must be 0.35 to 0.45 N·m.</li> <li>Confirm where the mounting position is, and tighten the auto switch fixing screw (M2.5) to fix the auto switch mounting nut. The tightening torque of the M2.5 screw must be 0.25 to 0.35 N·m.</li> <li>The detection position can be changed under the conditions in step ⑤.</li> </ol>	<ol style="list-style-type: none"> <li>Insert the mounting bracket into the mating groove of the cylinder tube.</li> <li>Check the detecting position of the auto switch and fix the auto switch firmly with the hexagon socket head cap screw (M2.5 x 12L).*</li> <li>If the detecting position is changed, go back to step ①.</li> </ol> <p>Note 1) Ensure that the auto switch is covered with the mating groove to protect the auto switch.</p> <p>Note 2) The tightening torque for the hexagon socket head cap screw (M2.5 x 12L) is 0.2 to 0.3 N·m.</p>										
	<p>• When tightening the auto switch mounting screw, use a watchmakers' screwdriver with a handle 5 to 6 mm in diameter.</p> <p><b>Tightening torque of auto switch mounting screw (N·m)</b></p> <table border="1"> <thead> <tr> <th>Auto switch model</th> <th>Tightening torque</th> </tr> </thead> <tbody> <tr> <td>D-M9□(V)</td> <td rowspan="3">0.05 to 0.15</td> </tr> <tr> <td>D-M9□W(V)</td> </tr> <tr> <td>D-A93</td> </tr> <tr> <td>D-M9□A(V)</td> <td rowspan="2">0.05 to 0.10</td> </tr> <tr> <td>D-A9□(V)</td> </tr> <tr> <td>(Excludes the D-A93)</td> <td>0.10 to 0.20</td> </tr> </tbody> </table>	Auto switch model	Tightening torque	D-M9□(V)	0.05 to 0.15	D-M9□W(V)	D-A93	D-M9□A(V)	0.05 to 0.10	D-A9□(V)	(Excludes the D-A93)	0.10 to 0.20	 <p>Auto switch mounting screw (M2.5 x 0.45 x 8L)</p> <p>Auto switch</p> <p>Auto switch mounting nut</p>	 <p>Auto switch fixing screw (M2.5 x 0.45 x 10L)</p> <p>Auto switch mounting screw (M3 x 0.5 x 8L)</p> <p>Auto switch</p> <p>Auto switch spacer</p> <p>Auto switch mounting nut</p>
Auto switch model	Tightening torque													
D-M9□(V)	0.05 to 0.15													
D-M9□W(V)														
D-A93														
D-M9□A(V)	0.05 to 0.10													
D-A9□(V)														
(Excludes the D-A93)	0.10 to 0.20													

Note) The auto switch mounting bracket and auto switch are enclosed with the cylinder for shipment.

Other than the models listed in "How to Order", the following auto switches are applicable.  
For detailed specifications, refer to pages 1341 to 1435.

Auto switch type	Model	Electrical entry	Features	Applicable bore size
Reed	D-A72, A73	Grommet (Perpendicular)	—	ø20 to ø63
	D-A80		Without indicator light	
	D-A79W		Diagnostic indication (2-color indicator)	
	D-A73C	Connector (Perpendicular)	—	
	D-A80C		Without indicator light	
	D-A72H, A73H, A76H		—	
D-A80H	Grommet (In-line)	Without indicator light		
Solid state	D-F7NV, F7PV, F7BV	Grommet (Perpendicular)	—	ø20 to ø63
	D-F7NVV, F7BWW		Diagnostic indication (2-color indicator)	
	D-F7BAV		Water resistant (2-color indicator)	
	D-J79C	Connector (Perpendicular)	—	
	D-F79, F7P, J79		—	
	D-F79W, F7PW, J79W		Diagnostic indication (2-color indicator)	
	D-F7BA		Water resistant (2-color indicator)	
	D-F79F		With diagnostic output (2-color indicator)	
	D-F7NT		With timer	

\* With pre-wired connector is also available for solid state auto switches. For details, refer to pages 1410 and 1411.

## Mounting

### ⚠ Caution

#### When a Magnetic Body Surrounds the Cylinder

- When a magnetic body surrounds the cylinder as shown in the figure below (including when the magnetic body is only on one side of the cylinder), the movement of the auto switch may become unstable, so please contact SMC.

ø12 to ø16  
ø32 to ø63

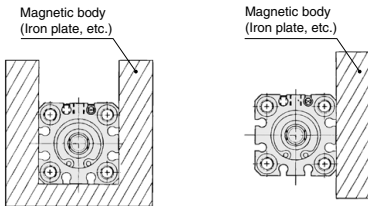

ø20, ø25

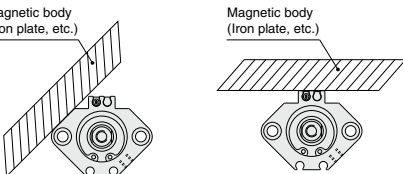

#### With Magnetic Field Resistant Auto Switch D-P3DWA

- If welding cables or welding gun electrodes are in the vicinity of the cylinder, the magnets in the cylinder could be affected by the external magnetic fields. (Please contact SMC if the welding amperage exceeds 16000 A.) If the source of strong magnetism comes in contact with the cylinder with an auto switch, make sure to install the cylinder away from the source of the magnetism.  
If the cylinder is to be used in an environment in which spatter will come in direct contact with the lead wires, cover the lead wires with a protective tube. For the protective tube, use a tube I.D. ø7 or more, which excels in heat resistance and flexibility.  
Please contact SMC if an inverter welder or a DC welder will be used.

# MK Series

# Made to Order: Individual Specifications 1

Please contact SMC for detailed dimensions, specifications and lead times.



## 1 Max. Operating Pressure 1.0 MPa **-X2071**

Symbol

MK **Mounting** 63 - **Stroke** Rotary direction **N Z - X2071**

- Use this specification if the pressure is between 0.61 and 1.0 MPa when using MK□63-□□□.

- The rod end and arm dimensions are different from those of the standard type. (Refer to the "Without arm" diagram below.) Be sure to use the dedicated MK-A063-X2071 arm assembly, and do not use the MK-A050Z standard arm.

- When manufacturing the arm, use the same design as the MK-A063-X2071 for the piston rod connecting part. (Refer to the "With arm" diagram below.)

**Body option**

Nil	Without arm
N	With arm

**Max. operating pressure** 1.0 MPa

### Specifications

Bore size (mm)	63
Operating pressure range	0.1 to 1.0 MPa

\* Specifications other than the above are the same as the standard.

## Construction/Dimensions

(The outline dimensions shown are when the rod is retracted.) Dimensions other than those marked with "\*" are the same as the standard.

### Without arm

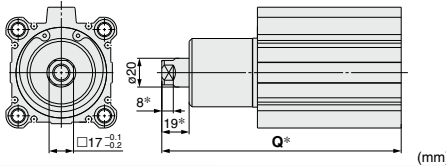

Model	Rod state	Q			
		Clamp stroke			
		10 mm	20 mm	30 mm	50 mm
MK□63-□□Z-X2071	Retracted	146.5	166.5	186.5	226.5
	Extended	175.5	205.5	235.5	295.5

### With arm

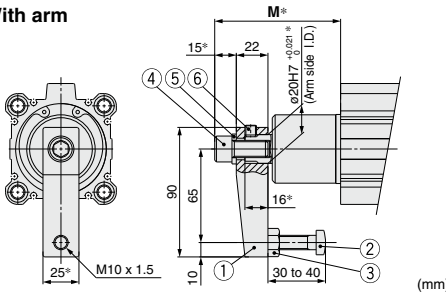

Model	Rod state	M			
		Clamp stroke			
		10 mm	20 mm	30 mm	50 mm
MK□63-□□Z-X2071	Retracted	77.5	87.5	97.5	117.5
	Extended	106.5	126.5	146.5	186.5

## Arm assembly

### MK-A063-X2071

Max. operating pressure 1.0 MPa

### Arm Assembly Component Parts

No.	Description	Material	Note
1	Arm	Rolled steel	
2	Clamp bolt	Chromium molybdenum steel	
3	Hexagon nut	Rolled steel	
4	Hexagon socket head cap screw	Chromium molybdenum steel	M12 x 25L
5	Spring washer	Hard steel	
6	Hexagon socket head set screw	Chromium molybdenum steel	Flat point M8 x 8L

\* The arm assembly consists of the parts No. 1 to 6.

## 2 Overall Length Is the Same as the Previous MK2 Series **-X2094**

Symbol

MK **Mounting** Bore size - **Stroke** Rotary direction **Body option** Z - **X2094**

- The overall length Q (from the end on the head side to the rod end) is the same as the MK2 series.

Overall length is the same as the MK2 series

### Applicable bore size/Stroke

Bore size	Stroke
ø20	10, 20
ø25	
ø32	
ø40	
ø50	20, 50
ø63	

## Dimensions

(The outline dimensions shown are when the rod is retracted.) Dimensions other than those marked with "\*" are the same as the standard.

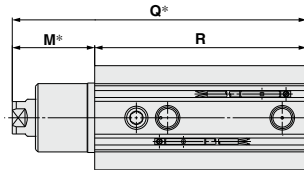

Bore size	Rod state	Clamp stroke								
		10 mm			20 mm			50 mm		
		Q	R	M	Q	R	M	Q	R	M
ø20	Retracted	95.5	72	23.5	115.5	82	33.5	—	—	—
	Extended	115	72	43	145	82	63	—	—	—
ø25	Retracted	98.5	73	25.5	118.5	83	35.5	—	—	—
	Extended	118	73	45	148	83	65	—	—	—
ø32	Retracted	121.5	81.5	40	141.5	91.5	50	—	—	—
	Extended	146.5	81.5	65	176.5	91.5	85	—	—	—
ø40	Retracted	122.5	75	47.5	142.5	85	57.5	—	—	—
	Extended	147.5	75	72.5	177.5	85	92.5	—	—	—
ø50	Retracted	—	—	—	162	96.5	65.5	222	126.5	95.5
	Extended	—	—	—	201	96.5	104.5	291	126.5	164.5
ø63	Retracted	—	—	—	165	100	65	225	130	95
	Extended	—	—	—	204	100	104	294	130	164



### 3 With Boss in Head End

Symbol  
**-X2172**

MKB **Bore size** - **Stroke** **Rotary direction** **Body option** Z - **X2172**

↓ With boss in head end

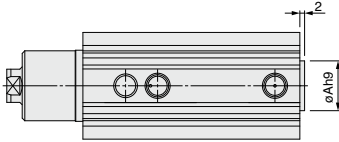

Bore size	$\phi A h9$
$\phi 20$	13 $\begin{smallmatrix} 0 \\ -0.043 \end{smallmatrix}$
$\phi 25$	15 $\begin{smallmatrix} 0 \\ -0.043 \end{smallmatrix}$
$\phi 32$	21 $\begin{smallmatrix} 0 \\ -0.052 \end{smallmatrix}$
$\phi 40$	28 $\begin{smallmatrix} 0 \\ -0.052 \end{smallmatrix}$
$\phi 50$	35 $\begin{smallmatrix} 0 \\ -0.062 \end{smallmatrix}$
$\phi 63$	35 $\begin{smallmatrix} 0 \\ -0.062 \end{smallmatrix}$

### 4 The Dimension of Head End Flange is the Same as the Previous MK and MK2 Series

Symbol  
**-X2177**

MKG **Bore size** - **Stroke** **Rotary direction** **Body option** Z - **X2177**

↓ The dimension of head flange is the same as the previous MK and MK2 series

- The mounting dimension of head end flange and pin hole size are the same as the previous MK and MK2 series.

Note) A centering location ring is used for the connection part between the cylinder and head end flange.

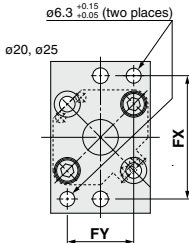

Bore size	FX	FY
$\phi 20$	48	25.5
$\phi 25$	52	28
$\phi 32$	56	—
$\phi 40$	62	—
$\phi 50$	76	—
$\phi 63$	92	—

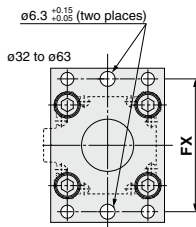

**5 Rotary Angle 60° Specifications**

Symbol

**-X2997**

MK Mounting Bore size - Stroke Rotary direction Body option Z - Auto switch - X2997

● Rotary angle 60° specifications

**Specifications**

Bore size (mm)	12	16	20	25	32	40	50	63
Rotary angle (°)	60 ±10							
Rotary stroke (mm)	5	5	6.3	6.3	10	10	12.7	12.7

\* Specifications other than the above are the same as the standard.

**Dimensions: Same as standard product**

**Rotary Angle**

