

Air Cooled Aftercooler

HAA Series

The HAA series can cool high temperature compressed air from compressors down to 40°C or less and efficiently remove moisture from the air. The air cooled aftercooler does not require cooling equipment and is free from concerns such as water supply cut-off or freezing. Maintenance is easy and the running cost is reasonable.

Compact size and lightweight
Uses minimal floor space
Built-in drain separator
Dust-protecting filter optional



HAA15



HAA7

Symbol



Working Principle

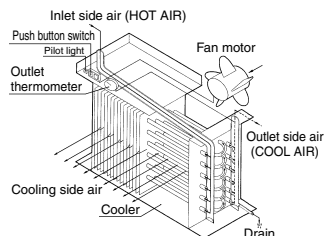

Model/Standard Specifications

Model		HAA7	HAA15	HAA22	HAA37			
Rated performance	Max. flow capacity (L/min (ANR)) ⁽¹⁾	1000	2200	3300	5700			
	Inlet air temperature (°C)	70						
	Inlet air pressure (MPa)	0.7						
	Ambient temperature (°C)	32						
	Outlet air temperature (°C)	40						
Operating performance	Fluid	Compressed air						
	Inlet air temperature (°C)	5 to 100						
	Inlet air pressure (MPa)	0.05 to 1.0 (With auto drain: 0.15 to 1.0) 0.05 to 0.97 (With auto drain: 0.15 to 0.97)						
	Ambient temperature (°C)	2 to 50						
Electrical specifications	Installation features	Indoor						
	Power source	Single phase 100 VAC (50/60 Hz)	Single phase 200 VAC (50/60 Hz)	Single phase 100 VAC (50/60 Hz)	Three phases 200 VAC (50/60 Hz)	Three phases 200 VAC (50/60 Hz)		
	Power consumption (W)	50 Hz	55	58	55	50	90	276
		60 Hz	58	65	65	60	130	346
	Current (A)	50 Hz	0.8	0.43	0.8	0.4	0.4	2.2
		60 Hz	0.81	0.46	0.9	0.35	0.45	2.0
Proof pressure (MPa)	1.5							
Cooling fan dia. (mm)	255		300		400	350 x 2 pcs.		
Cooler		Aluminum plate tube with fins						
Port size for inlet/outlet air		Rp 3/4 socket		1B union		1 1/2B union		
Port size for drain outlet piping (Auto drain)		Rc 3/8 (Rc 3/8)			Rc 1/2 (Rc 3/8)			
Weight (kg)		18	24	36	55			
Coating color		Munsell N-8 (White), Munsell 2.5PB5/6.5 (Blue)						
Applicable compressor (kW) ⁽²⁾		7.5	15	22	37			
Standard equipment	Thermometer for outlet air temp. (1 pc.)	—	●	●	●			
Accessory ⁽³⁾	Drain valve (1 pc.)	3/8B			1/2B			
	Union (2 pcs.)	—	1B	1 1/2B				

Note 1) ANR indicates the flow rate converted to the value at 20°C under the atmospheric pressure and the state of relative humidity 65%.

Note 2) Based on discharge rate and discharge temperature (70°C) of screw type compressors.

Note 3) The accessories should be mounted by user.

Option Specifications

Applicable model	HAA7	HAA15	HAA22	HAA37
With terminal	●	●	●	(Standard) *

* HAA37 has an external push button with terminal.

Accessory (Option)

Applicable model	HAA7	HAA15	HAA22	HAA37
Auto drain	AD402-03D-6-A			AD402-04D-6-A
Dust-protecting filter	HAA7-F	HAA15-F	HAA22-F	HAA37-F
Mounting bench	HAA7-S	HAA15-S	HAA22-S	HAA37-S

* The accessories should be mounted by user.

Model Selection (Flow Capacity L/min (ANR))

Model		HAA7	HAA15	HAA22	HAA37
Inlet air temperature	50°C	1500	4000	6000	7000
	70°C	1000	2200	3300	5700
	100°C	700	1500	2200	4300

Conditions: Outlet temperature 40°C, Ambient temperature 32°C, Air pressure 0.7 MPa

How to Order

HAA 15 - 10 1 - - -

Basic size

Symbol	Applicable air compressor
7	7.5 kW
15	15 kW
22	22 kW
37	37 kW

Port size

Symbol	Size	Applicable model
06	Rp 3/4 socket	HAA7
10	1 st union	HAA15
14	1 1/2 nd union	HAA22, 37

Suffix

Symbol	Description
Nil	—
T	With terminal (Provided as standard for HAA37.)

Accessory (Option)

Symbol	Description
Nil	—
D	Auto drain
F	Dust-protecting filter
S	Mounting bench

Source voltage

Symbol	Voltage	Applicable model
1	Single phase 100 VAC	HAA7, 15
2	Single phase 200 VAC	HAA7
3	Three phase 200 VAC	HAA15, 22, 37

How to Calculate Outlet Air Temperature

Outlet air temperature can be calculated with inlet air temperature, ambient temperature and amount of air in the following procedure.

(Example) Inlet air temperature: 100°C, Ambient temperature: 20°C, Amount of air: 2000 L/min (ANR), Air pressure: 0.7 MPa, Model: HAA22-14

Outlet Air Temperature at Above Conditions

- (1) Use outlet air temperature of 38.5°C from outlet air temperature table. At this time correction factor line becomes ⊙.
- (2) To get correction factor of 1.35 use ambient temperature correction factor ⊙ at 20°C.
- (3) To get outlet air temperature divide 38.5°C from (1) by 1.35 from (2).
Outlet temperature = 38.5 ÷ 1.35 = 28.5°C

Correction Factor by Ambient Temperature

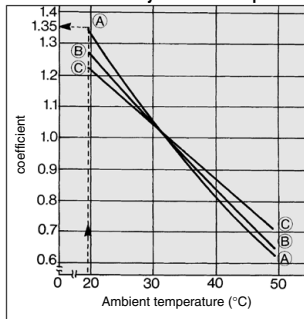

Outlet Air Temperature

Model	Correction factor	Air flow (L/min (ANR))	Inlet air temperature (°C)		
			50°C	70°C	100°C
HAA7	(A)	500	34.5	35	35.5
	(B)	1000	38	40	42.5
	(C)	1500	40	44	47.5
HAA15	(A)	1000	33	35.5	36
	(B)	2200	36.5	40	42.5
	(C)	3000	38	42	44
HAA22	(A)	2000	34	37	38.5
	(B)	3300	36	40	42.5
	(C)	4000	37	41.5	45
HAA37	(A)	4000	34	38	39
	(B)	5700	35	40	43
	(C)	7000	36	42	45

Conditions: • Air pressure 0.7 MPa, Ambient temperature 32°C.
• Inlet air temperature 50°C is saturated air. At 70°C or more, it is humid air with dew point 67°C.

⚠ Precautions

- Be sure to read this before handling the products.
- For safety instructions and air preparation equipment precautions, refer to the "Handling Precautions for SMC Products" and the "Operation Manual" on the SMC website: <https://www.smcworld.com>

Caution on Design

⚠ Caution

1. Do not obstruct the aftercooler's vent inlet and outlet, and install the equipment more than 20 cm away from the walls or other equipment.
2. Install the aftercooler in a location that facilitates maintenance and inspection.
3. Install the aftercooler in a location with minimal vibrations.
4. Ventilate the area because the surrounding temperature increases due to the exhaust heat from the aftercooler.
5. The air cooled type aftercooler cannot be used in a location in which the temperature exceeds 50°C. In such a case, use a water cooled type aftercooler instead.
6. The maximum allowable temperature of the inlet air is 100°C. If the inlet air exceeds this temperature, select an appropriate water cooled type aftercooler.
7. Prevent fins from becoming clogged. Do not use this aftercooler in an area that has viscous dust (electrostatic paint powder, oily particles, etc.). If it must be used under such conditions due to unavoidable circumstances, please contact SMC beforehand.

Mounting

⚠ Caution

1. Do not interchange the connections to the compressed air inlet and the compressed air outlet. When tightening the air inlet and outlet piping, make sure to use a pipe wrench to hold the inlet and outlet nozzles of the product.
2. Connect a drain pipe because drainage is created when the compressed air is cooled.
3. The drain pipe must have a minimum pipe bore of 10 mm, and a maximum length of 5 m (when installing an optional auto-drain).

Maintenance

⚠ Caution

1. Inspect the cooler at least once a week and clean it to prevent it from becoming obstructed.
2. Discharge the drainage on a regular basis in accordance with the amount of drainage that is created. (Use of an optional auto drain is recommended for automatic discharge.)

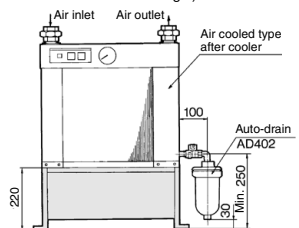

If the aftercooler is equipped with an auto-drain, the following mounting frame is necessary.
Mounting frame (Option: Refer to page 26, Accessories.)

HAA Series

Flow Rate Characteristics Air pressure 0.7 MPa

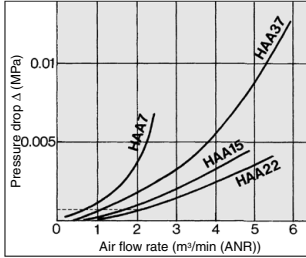

(Example) To get pressure drop at 0.3 MPa of air pressure, 2000 L/min (ANR) of air flow, and model HAA22, use $\Delta P = 0.0007$ MPa at 0.7 MPa from the table and convert P_1 to 0.3 MPa.

$$\begin{aligned} \text{Pressure drop} &= \frac{(0.7 + 0.1013) \times \Delta P}{P_1 + 0.1013} \\ &= \frac{0.8013 \times 0.0007}{0.3 + 0.1013} \\ &= 0.0014 \text{ MPa} \end{aligned}$$

Dimensions

HAA7

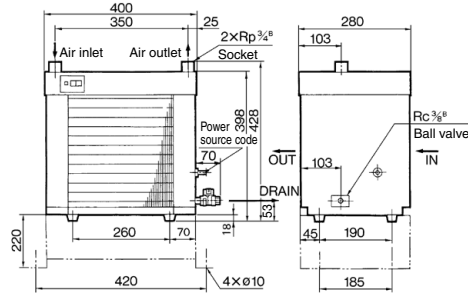

HAA37

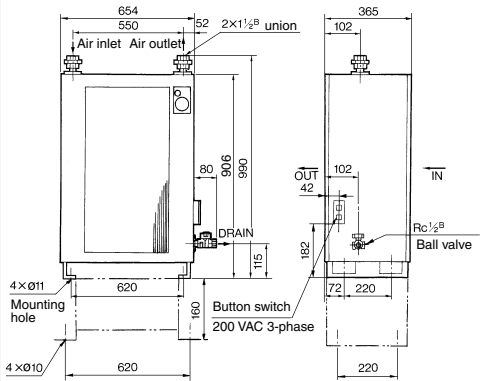

HAA15/22

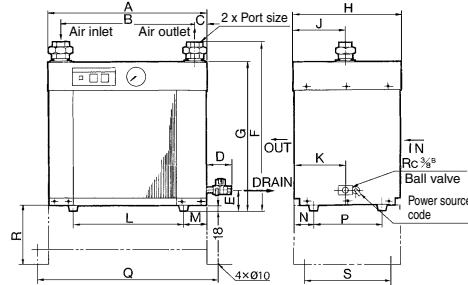

Model	Port size	A	B	C	D	E	F	G	H	J	K	L	M	N	P	Q	R	S
HAA15	1" union	460	394	33	70	59	485	428	320	150	150	320	70	58	200	480	220	225
HAA22	1 1/2" union	588	484	52	70	60	580	505	333	150	150	400	94	65	200	610	220	238