

Angular Type Air Gripper

MHC2/MHCA2/MHCM2 Series

ø6, ø7

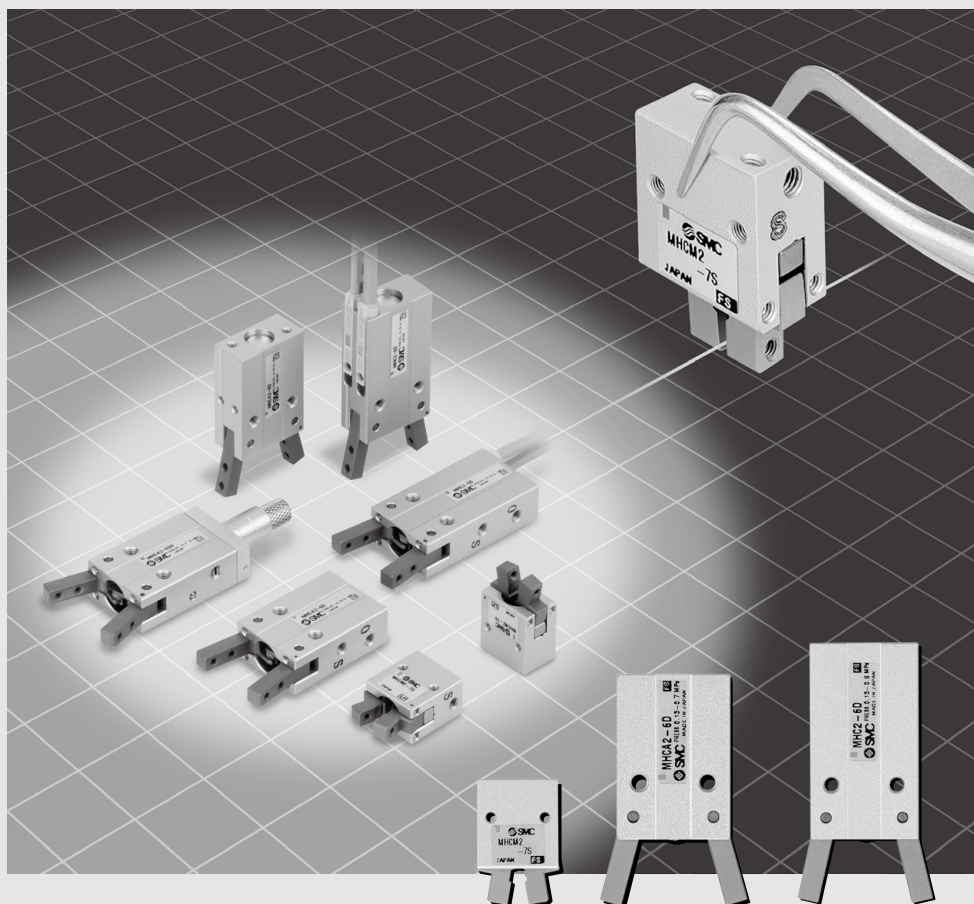

Angular type air gripper

MHC2/MHCA2/MHCM2 Series

MHC2-6□

Auto switch is attachable.

48 mm x 20 mm x 10 mm 22 g

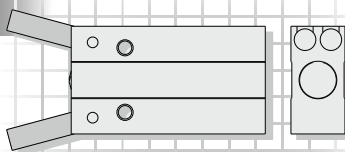

MHCA2-6□

Short body.

41 mm x 20 mm x 10 mm 19 g

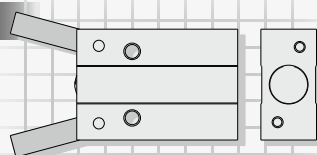

MHCM2-7S

Smallest size and lightest weight in MHC series.

23 mm x 15 mm x 10 mm 9.5 g

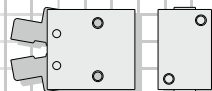

Body option (Only for MHCA2-6)

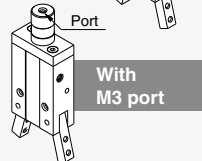
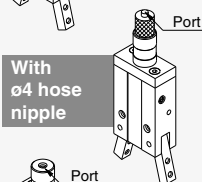
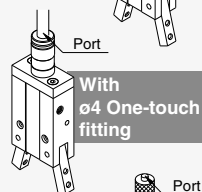
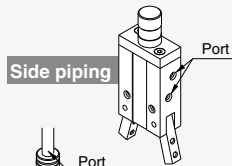

Variations



Model	MHC2-6□	MHCA2-6□	MHCM2-7S
Cylinder bore	ø6	ø6	ø7
Action	Double acting Single acting (Normally open)		Single acting (Normally open)
Opening/Closing angle (Both sides)	30° to -10°		20° to -7°
Holding moment (at 0.5 MPa)	0.038 N-m (Double acting) 0.024 N-m (Single acting)		0.017 N-m
Repeat ability	±0.02 mm		
Maximum operating frequency	180 c. p.m		
Weight	22 g (Note)	19 g	9.5 g
Auto switch	Solid state auto switch (2-wire, 3-wire)	—	—
Body option	—	End boss type	—

Note) Not including auto switch weight.



MHC2/MHCA2/MHCM2 Series Specific Product Precautions

Be sure to read this before handling the products.

Mounting

Warning

1. Tighten the screw within the specified torque range when mounting the air gripper.
Tightening with a torque above the limit can cause malfunction, while insufficient tightening can cause slippage and dropping.

How to Mount Air Grippers

Axial Mounting (Body tapped)

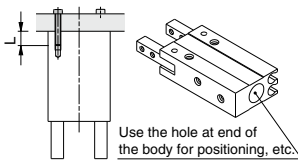

Model	Bolt	Max. tightening torque N·m	Max. screw-in depth L mm
MHCA2-6	M2 x 0.4	0.15	6
MHCM2-7S	M2 x 0.4	0.15	4

Note) MHC2-6 is not compatible with axial mounting.

Model	Hole dia. mm	Hole depth mm
MHCA2-6	$\phi 7H_8^{+0.022}$	1.5

Vertical mounting (Body tapped)

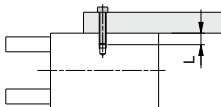

Model	Bolt	Max. tightening torque N·m	Max. screw-in depth L mm
MHCA2-6	M2 x 0.4	0.15	4

Note) MHC2-6 and MHCM2-7S are not compatible with vertical mounting.

Lateral mounting (Body tapped, body through-hole)

● Body tapped

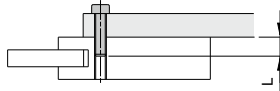

Model	Bolt	Max. tightening torque N·m	Max. screw-in depth L mm
MHC2-6	M3 x 0.5	0.88	10
MHCA2-6	M3 x 0.5	0.88	10
MHCM2-7S	M2 x 0.4	0.15	10

● Body through-hole

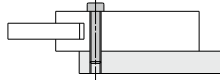

Model	Bolt	Max. tightening torque N·m
MHC2-6	M2.5 x 0.45	0.49
MHCA2-6	M2.5 x 0.45	0.49

Note) MHCM2-7S is not compatible with body through-hole mounting.

Warning

2. Do not scratch or dent the air gripper by dropping or bumping it when mounting.
Slight deformation can cause inaccuracy or a malfunction.
3. Tighten the screw within the specified torque range when mounting the attachment.
Tightening with a torque above the limit can cause malfunction, while insufficient tightening can cause slippage and dropping.

How to Mount Attachment to the Finger

Make sure to mount the attachments on fingers with the tightening torque in the table below by using bolts, etc., for the female threads on fingers.

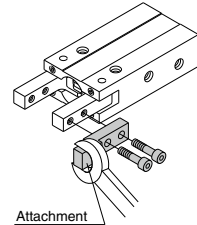

Model	Bolt	Max. tightening torque N·m
MHC□2-6	M2 x 0.4	0.15
MHCM2-7S	M2 x 0.4	0.15

Operating Environment

Caution

Use caution for the anti-corrosiveness of finger guide section.

Except for some models, martensitic stainless steel is used for the finger. However, be aware that its anti-corrosion performance is inferior to austenitic stainless steel. In particular, the finger might be rusted in an environment where water droplets are adhered to it due to dew condensation.

MHC2/MHCA2/MHCM2 Series

Model Selection

Model Selection

Selection Procedure



Step 1 Confirmation of Gripping Force

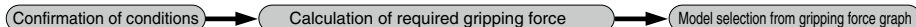

Example Workpiece mass: **0.01 kg**

Gripping method: External gripping

Model selection criteria with respect to workpiece mass

- Although differences will exist depending on factors such as shape and the coefficient of friction between the attachments and workpieces, select a model which will provide a gripping force 10 to 20 times the ^(Note 1) weight of the workpiece.
- (Note 1) Refer to the model selection illustration for more information.
- Furthermore, in cases with high acceleration or impact, etc., it is necessary to allow an even greater margin of safety.

Example: When it is desired to set the gripping force at 10 times or more the workpiece weight.
 Required gripping force = $0.01 \text{ kg} \times 10 \times 9.8 \text{ m/s}^2$
 = Approx. 0.98 N or more

Length of gripping point: **25mm**

Operating pressure: **0.4MPa**

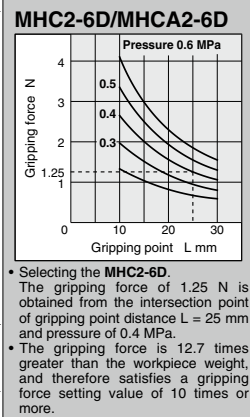

Model Selection Illustration

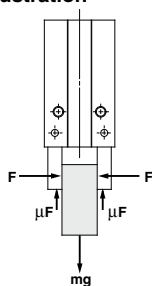

When gripping a workpiece as in the figure to the left and with the following definitions,
F: Gripping force (N)
μ: Coefficient of friction between attachments and workpiece
m: Workpiece mass (kg)
g: Gravitational acceleration (= 9.8 m/s²)
mg: Workpiece weight (N)

the conditions under which the workpiece will not drop are

$$2 \times \mu F > mg$$

Number of fingers

and therefore,

$$F > \frac{mg}{2 \times \mu}$$
 With "a" as the safety margin,
 F is determined as follows:

$$F = \frac{mg}{2 \times \mu} \times a$$

Gripping force at least 10 to 20 times the workpiece weight
 The "10 to 20 times or more of the workpiece weight" recommended by SMC is calculated with the safety margin of a = 4, which allows for impacts that occur during normal transportation, etc.

When $\mu = 0.2$	When $\mu = 0.1$
$F = \frac{mg}{2 \times 0.2} \times 4$ $= 10 \times mg$	$F = \frac{mg}{2 \times 0.1} \times 4$ $= 20 \times mg$

10 x workpiece weight 20 x workpiece weight

(Note) - Even in cases where the coefficient of friction is greater than $\mu = 0.2$, for safety reasons, SMC recommends selecting a gripping force which is at least 10 to 20 times the workpiece weight.
 - It is necessary to allow a greater safety margin for high accelerations and strong impacts, etc.

Step 1 Effective Gripping Force: MHC□2 Series External Gripping Force

- Expressing the effective gripping force

The effective gripping force shown in the graphs to the right is expressed as F , which is the thrust of one finger when both fingers and attachments are in full contact with the workpiece as shown in the figure below.

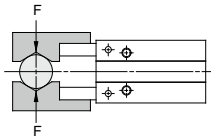

External Gripping

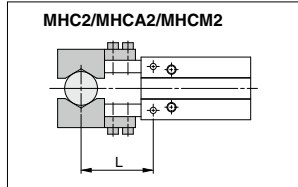

- If there is an overhang, please consult with SMC.

MHC2-6D/MHCA2-6D

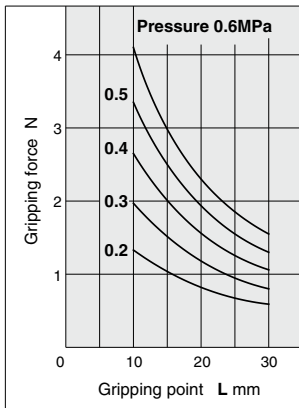

MHC2-6S/MHCA2-6S

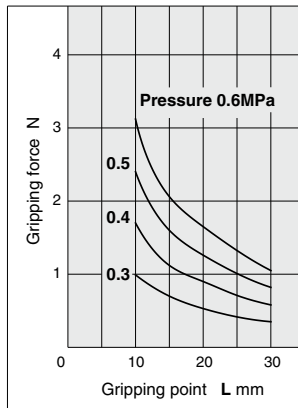

MHCM2-7S

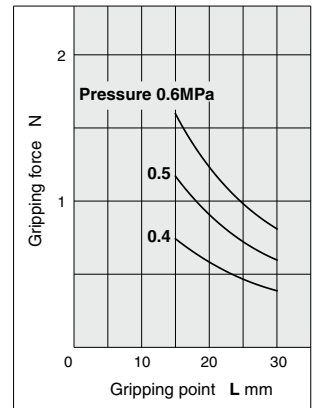

MHC2/MHCA2/MHCM2 Series

Step 2 Confirmation of Inertial Moment of Attachment

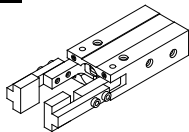

Confirm the inertial moment of one of the two attachments.
For example, in calculating the inertial moment of an attachment in the picture on the left, divide it into 2 rectangular parallelepipeds, A part and B part.

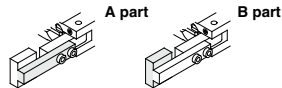

Procedure	Formula	Example						
<p>1. Calculate the operating conditions and attachment dimensions.</p>	<p>A part</p> <p>B part</p>	<p>Operating equipment: MHC2-6D a = 20 (mm) b = 3 (mm) c = 4 (mm) d = 4 (mm) e = 5 (mm) f = 6 (mm)</p>						
<p>2. Calculate the inertial moment of the attachment.</p>	<p>A part</p> <p>Weight calculation $m_1 = a \times b \times c \times \text{Relative density}$</p> <p>Inertial moment around Z1 axis $I_{z1} = \{m_1 (a^2 + b^2) / 12\} \times 10^{-6}$</p> <p>Inertial moment around Z axis $I_A = I_{z1} + m_1 f_1^2 \times 10^{-6}$</p> <p>B part</p> <p>Weight calculation $m_2 = d \times e \times f \times \text{Relative density}$</p> <p>Inertial moment around Z2 axis $I_{z2} = \{m_2 (d^2 + e^2) / 12\} \times 10^{-6}$</p> <p>Inertial moment around Z axis $I_B = I_{z2} + m_2 f_2^2 \times 10^{-6}$</p> <p>Thus, the total inertial moment is $I = I_A + I_B$ <small>(*: Unit conversion constant)</small></p>	<p>Assuming the attachment material is aluminium alloy (relative density=2.7), $r_1 = 16.4$ (mm).</p> <p>$m_1 = 20 \times 3 \times 4 \times 2.7 \times 10^{-6}$ $= 6.48 \times 10^{-4}$ (kg)</p> <p>$I_{z1} = \{6.48 \times 10^{-4} \times (20^2 + 3^2) / 12\} \times 10^{-6}$ $= 2.21 \times 10^{-8}$ (kg·m²)</p> <p>$I_A = 2.21 \times 10^{-8} + 6.48 \times 10^{-4} \times 16.4^2 \times 10^{-6}$ $= 0.20 \times 10^{-6}$ (kg·m²)</p> <p>$r_2 = 23.5$(mm)</p> <p>$m_2 = 4 \times 5 \times 6 \times 2.7 \times 10^{-6}$ $= 3.24 \times 10^{-4}$ (kg)</p> <p>$I_{z2} = \{3.24 \times 10^{-4} \times (4^2 + 5^2) / 12\} \times 10^{-6}$ $= 1.11 \times 10^{-9}$ (kg·m²)</p> <p>$I_B = 1.11 \times 10^{-9} + 3.24 \times 10^{-4} \times 23.5^2 \times 10^{-6}$ $= 0.18 \times 10^{-6}$ (kg·m²)</p> <p>$I = 0.20 \times 10^{-6} + 0.18 \times 10^{-6}$ $= 0.38 \times 10^{-6}$ (kg·m²)</p>						
<p>3. Confirm from the table that the inertial moment of one attachment is within the allowable range.</p>	<p>MHC2-6D/MHCA2-6D</p> <table border="1"> <tr> <td>Finger opening and closing speed</td> <td>Allowable inertial moment of attachment</td> </tr> <tr> <td>Without speed controller</td> <td>0.5×10^{-6} Kg·m²</td> </tr> <tr> <td>With speed controller 3/4 to 1 and 1/2 reverse rotation from fully close state</td> <td>1.5×10^{-6} Kg·m²</td> </tr> </table> <p>Attachment inertial moment > Allowable inertial moment</p>	Finger opening and closing speed	Allowable inertial moment of attachment	Without speed controller	0.5×10^{-6} Kg·m ²	With speed controller 3/4 to 1 and 1/2 reverse rotation from fully close state	1.5×10^{-6} Kg·m ²	<p>Attachment inertial moment 0.38×10^{-6} (kg·m²) < Allowable inertial moment without speed controller 0.5×10^{-6} (kg·m²)</p> <p>Therefore, the attachment can be used without a speed controller.</p>
Finger opening and closing speed	Allowable inertial moment of attachment							
Without speed controller	0.5×10^{-6} Kg·m ²							
With speed controller 3/4 to 1 and 1/2 reverse rotation from fully close state	1.5×10^{-6} Kg·m ²							

Symbol

Symbol	Definition	Unit
Z	Central axis of finger rotation	—
Z1	Axis which contains center of gravity of attachment A part and is parallel to Z	—
Z2	Axis which contains center of gravity of attachment B part and is parallel to Z	—
I	Total inertial moment of attachment	kg·m ²
Iz1	Inertial moment around Z1 axis of attachment A part	kg·m ²
Iz2	Inertial moment around Z2 axis of attachment B part	kg·m ²
IA	Inertial moment around Z axis of attachment A part	kg·m ²
IB	Inertial moment around Z axis of attachment B part	kg·m ²
m1	Weight of attachment A part	kg
m2	Weight of attachment B part	kg
r1	Distance between axes Z and Z1	mm
r2	Distance between axes Z and Z2	mm

Limiting Range of Attachment Inertial Moment

MHC2-6D/MHCA2-6D

Finger opening and closing speed	Allowable inertial moment of attachment	Weight (Guide)
Without speed controller ^{Note)}	0.5 x 10 ⁻⁶ kg·m ²	2 g or less
With speed controller 3/4 to 1 and 1/2 reverse rotation from fully close state	1.5 x 10 ⁻⁶ kg·m ²	3.5 g or less

MHC2-6S/MHCA2-6S

Finger opening and closing speed	Allowable inertial moment of attachment	Weight (Guide)
Without speed controller ^{Note)}	0.5 x 10 ⁻⁶ kg·m ²	2 g or less
With speed controller 3/4 to 2 reverse rotation from fully close state	1.5 x 10 ⁻⁶ kg·m ²	3.5 g or less

MHCM2-7S

Finger opening and closing speed	Allowable inertial moment of attachment	Weight (Guide)
Without speed controller ^{Note)}	0.3 x 10 ⁻⁶ kg·m ²	2 g or less
With speed controller 1/2 to 1 3/4 reverse rotation from fully close state	1.0 x 10 ⁻⁶ kg·m ²	3.3 g or less

* Applicable speed controller ——— Air gripper direct connection type AS1211F-M3
 Use a meter-in type.
 Note) In the case of MHCM2-7S, provide a run off space because the speed controller protrudes from the body top surface by 0.6 mm.

Note) Sometimes the workpiece may not be gripped precisely because of excessive speed in finger opening and closing. Therefore, use a meter-in type speed controller to adjust the finger opening and closing speed.

Angular Type Air Gripper

MHC2-6/MHCA2-6 Series

ø6

How to Order

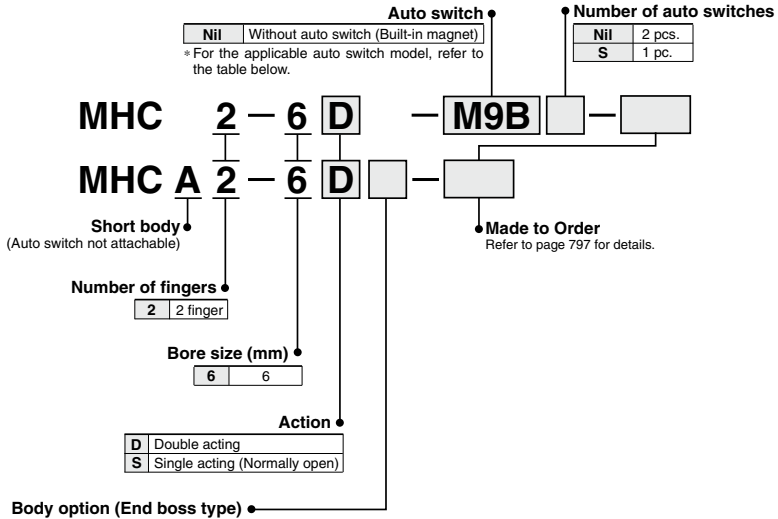

Nil: Basic type

E: Side ported
(Double acting/
Single acting)

K: Axial ported
with One-touch fitting
(Single acting)

H: Axial ported
with ø4 hose nipple
(Single acting)

M: Axial M3 port
(Single acting)

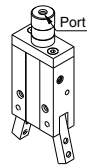
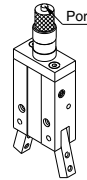
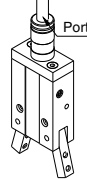
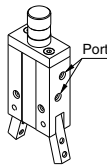
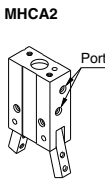
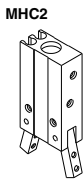

Applicable Auto Switches

Refer to pages 929 to 983 for further information on auto switches.

Type	Special function	Electrical entry	Indicator light	Wiring (Output)	Load voltage		Auto switch model		Lead wire length (m)*			Pre-wired connector	Applicable load
					DC	AC	Perpendicular	In-line	0.5 (Nil)	1 (M)	3 (L)		
Solid state auto switch	—	Grommet	Yes	3-wire (NPN)	5 V,	—	M9NV	M9N	●	●	○	○	IC circuit
				3-wire (PNP)	12 V		M9PV	M9P	●	●	○	○	
				2-wire	12 V		M9BV	M9B	●	●	○	○	
				3-wire (NPN)	5 V,		M9NWV	M9NW	●	●	○	○	
				3-wire (PNP)	12 V		M9PWV	M9PW	●	●	○	○	
				2-wire	12 V		M9BWW	M9BW	●	●	○	○	
	Diagnosis (2-color indicator)	Grommet	Yes	Yes	3-wire (NPN)	5 V,	M9NAV**	M9NA**	○	○	●	○	IC circuit
					3-wire (PNP)	12 V	M9PAV**	M9PA**	○	○	○	○	
					2-wire	12 V	M9BAV**	M9BA**	○	○	○	○	
					3-wire (NPN)	5 V,			○	○	○	○	
					3-wire (PNP)	12 V			○	○	○	○	
					2-wire	12 V			○	○	○	○	

** Water resistant type auto switches can be mounted on the above models, but in such case SMC cannot guarantee water resistance.

* Lead wire length symbols: 0.5 m Nil (Example) M9N

* Auto switches marked with "○" are made to order specification.

1 m M (Example) M9NM

3 m L (Example) M9NL

5 m Z (Example) M9NZ

Note) When using the 2-color indicator type, please make the setting so that the indicator is lit in red to ensure the detection at the proper position of the air gripper.

Angular Type Air Gripper **MHC2-6/MHCA2-6 Series**



Symbol

Double acting:
External grip

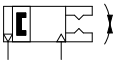

Single acting/ Normally open:
External grip



Made to Order
[Click here for details](#)

Symbol	Specifications/Description
-X4	Heat resistance (100°C)
-X5	Fluororubber seal
-X53	EPDM seal/Fluorine grease
-X56	Axial piping type
-X63	Fluorine grease
-X64	Finger: Side Tapped Mounting
-X65	Finger: Through-hole mounting
-X79	Grease for food processing machines, Fluorine grease
-X79A	Grease for food processing machines
-X81A	Anti-corrosive treatment of finger

Moisture Control Tube IDK Series



When operating an actuator with a small diameter and a short stroke at a high frequency, the dew condensation (water droplet) may occur inside the piping depending on the conditions.

Simply connecting the moisture control tube to the actuator will prevent dew condensation from occurring. For details, refer to the [Web Catalog](#).

Specifications

Fluid		Air
Operating pressure	Double acting	0.15 to 0.6 MPa
	Single acting: Normally open	0.3 to 0.6 MPa
Ambient and fluid temperature		-10 to 60°C
Repeatability		±0.02 mm
Maximum operating frequency		180 c.p.m
Lubrication		Non-lube
Action		Double acting, Single acting (Normally open)
Auto switch (Option) ^{Note)}		Solid state auto switch (3-wire, 2-wire)

Note) Refer to pages 929 to 983 for further information on auto switches.

Model

Action	Model	Cylinder bore (mm)	Gripping moment ⁽¹⁾ (Effective value) N·m	Opening/Closing angle (Both sides)	Weight ⁽²⁾ (g)
Double acting	MHC2-6D	6	0.038	30° to -10°	22
	MHCA2-6D	6			19
Single acting (Normally open)	MHC2-6S	6	0.024	30° to -10°	22
	MHCA2-6S	6			19

Note 1) At the pressure of 0.5 MPa

Note 2) Excluding the auto switch weight.

Option

●Body Option/End Boss Type

Symbol	Piping port location	Type of piping port	Applicable model	
		MHCA2-6	Double acting	Single acting
Nil	Basic type	M3 x 0.5	●	●
E	Side ported	M3 x 0.5	●	●
K	Axial ported	With ø4 One-touch fitting	—	●
H		With ø4 hose nipple	—	●
M		M3 x 0.5	—	●

MHC2-6/MHCA2-6 Series

Construction

MHC2-6

Double acting/With fingers open

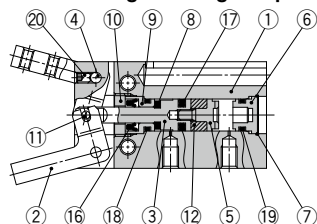

Double acting/With fingers closed Single acting

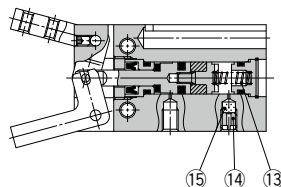
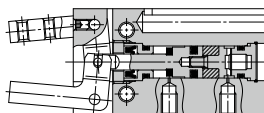

Component Parts

No.	Description	Material	Note
1	Body	Aluminum alloy	Hard anodized
2	Finger	Stainless steel	Heat treatment
3	Piston	Stainless steel	
4	Lever shaft	Stainless steel	Nitriding
5	Magnet holder	Stainless steel	
6	Cap	Aluminum alloy	Hard anodized
7	Clip	Stainless steel	
8	Bumper	Urethane rubber	
9	Holder	Brass	Electroless nickel plated
10	Holder lock	Stainless steel	

No.	Description	Material	Note
11	Needle roller	High carbon chromium bearing steel	Heat treated
12	Magnet	—	Nickel plated
13	N.O. spring	Piano wire	Zinc chromated
14	Exhaust plug	Brass	Electroless nickel plated
15	Exhaust filter A	Resin sponge	
16	Rod seal	NBR	
17	Piston seal	NBR	
18	Gasket	NBR	
19	Gasket	NBR	
20	Hexagon socket cap screw	Stainless steel	

Replacement Parts

Description	Kit no.	Main parts	Note
Seal kit		Please contact SMC to replace seal kit	

MHCA2-6 (Short body type)

Double acting/With fingers open

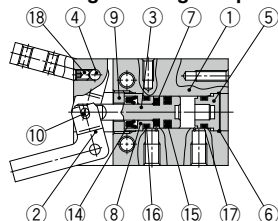

Double acting/With fingers closed Single acting

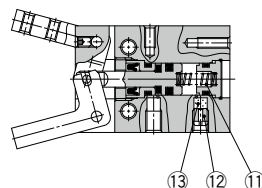
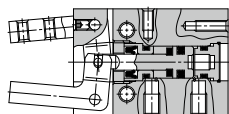

Component Parts

No.	Description	Material	Note
1	Body	Aluminum alloy	Hard anodized
2	Finger	Stainless steel	Heat treatment
3	Piston	Stainless steel	
4	Lever shaft	Stainless steel	Nitriding
5	Cap	Aluminum alloy	Hard anodized
6	Clip	Stainless steel	
7	Bumper	Urethane rubber	
8	Holder	Brass	Electroless nickel plated
9	Holder lock	Stainless steel	

No.	Description	Material	Note
10	Needle roller	High carbon chromium bearing steel	Heat treated
11	N.O. spring	Piano wire	Zinc chromated
12	Exhaust plug	Brass	Electroless nickel plated
13	Exhaust filter A	Resin sponge	
14	Rod seal	NBR	
15	Piston seal	NBR	
16	Gasket	NBR	
17	Gasket	NBR	
18	Hexagon socket cap screw	Stainless steel	

Replacement Parts

Description	Kit no.	Main parts	Note
Seal kit		Please contact SMC to replace seal kit	

Dimensions

MHC2-6□

4 x M2 x 0.4 through
Thread for attachment
mounting

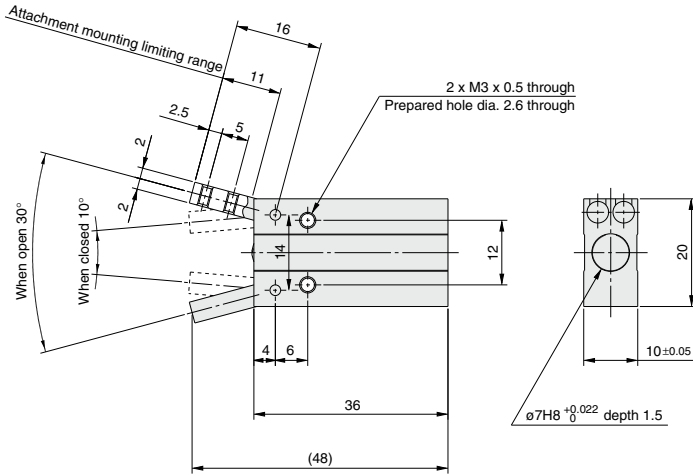
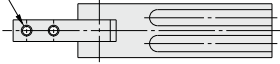

Auto switch mounting groove dimensions

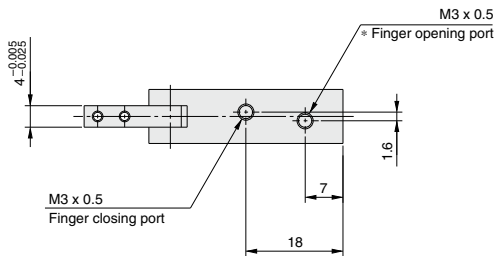

* In the case of MHC2-6S, finger opening port is a breathing hole.

MHC2-6/MHCA2-6 Series

Dimensions

MHCA2-6□ (Short body type)

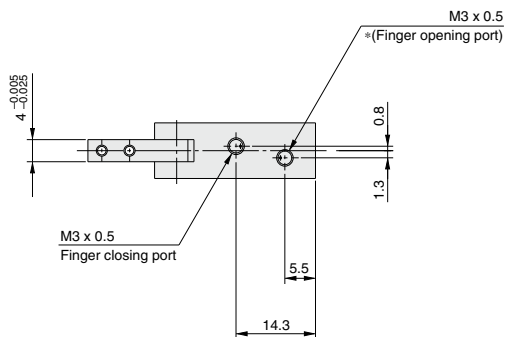
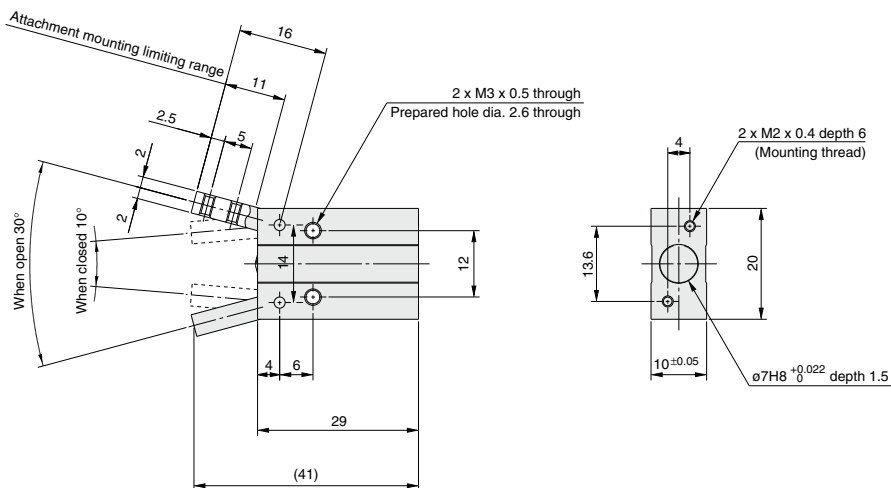
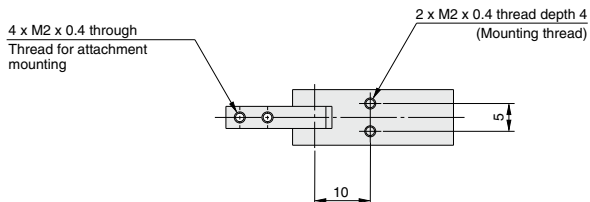

* In the case of MHCA2-6S, finger opening port is a breathing hole.

MHCA2 Series

Body Option: End Boss Type

Applicable Model

Symbol	Piping port location	Type of piping port	Applicable model	
			Double acting	Single acting
E	Side ported	M3 x 0.5	●	●
H	Axial ported	With ø4 hose nipple	—	●
K		With ø4 One-touch fitting	—	●
M		M3 x 0.5	—	●

Side Ported [E]

MHCA2-6□E

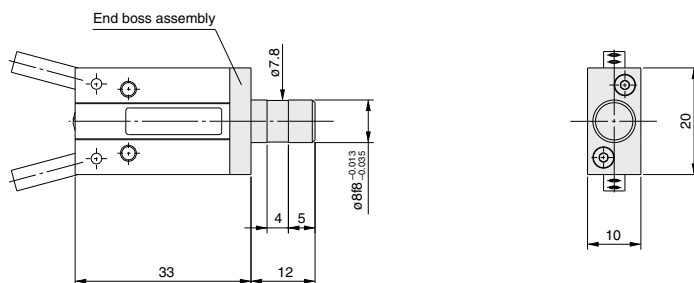

* The specifications and dimensions not given above are identical with those of the standard type.

Axial Ported (With hose nipple) [H]

MHCA2-6SH

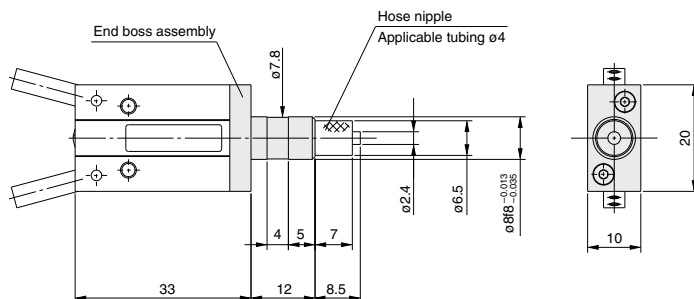

* The specifications and dimensions not given above are identical with those of the standard type.

Applicable Tubing

Description/Model	Nylon tubing	Soft nylon tubing	Polyurethane tubing	Polyurethane coil tubing
	T0425	TS0425	TU0425	TCU0425B-1
Specifications				
Outside diameter mm	4	4	4	4
Max. operating pressure MPa	1.0	0.8	0.5	0.5
Min. bending radius mm	13	12	10	—
Operating temperature °C	-20 to 60	-20 to 60	-20 to 60	-20 to 60
Material	Nylon 12	Nylon 12	Polyurethane	Polyurethane

Refer to the **Web Catalog** regarding One-touch fittings and tubing.

MHC2-6/MHCA2-6 Series

Axial Ported (With One-touch fitting) [K]

MHCA2-6SK

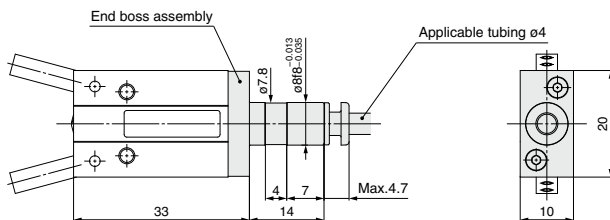

* The specifications and dimensions not given above are identical with those of the standard type.

Applicable Tubing

Description/Model	Nylon tubing	Soft nylon tubing	Polyurethane tubing	Polyurethane coil tubing
Specifications	T0425	TS0425	TU0425	TCU0425B-1
Outside diameter mm	4	4	4	4
Max. operating pressure MPa	1.0	0.8	0.5	0.5
Min. bending radius mm	13	12	10	—
Operating temperature °C	-20 to 60	-20 to 60	-20 to 60	-20 to 60
Material	Nylon12	Nylon12	Polyurethane	Polyurethane

Refer to the [Web Catalog](#) regarding One-touch fittings and tubing.

Axial Ported (With M3 port) [M]

MHCA2-6SM

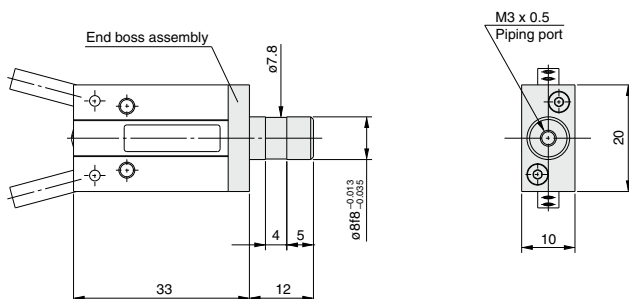

* The specifications and dimensions not given above are identical with those of the standard type.

Weight

Unit: g

Model	End boss type (Symbol)			
	E	H	K	M
MHCA2-6□□	23	23	23	23

MHC2-6/MHCA2-6 Series

Auto Switch Installation Examples and Mounting Positions

Various auto switch applications are possible through different combinations of auto switch quantities and detecting positions.

1) Detection when Gripping Exterior of Workpiece

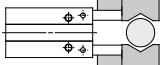
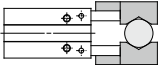
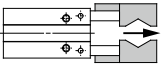
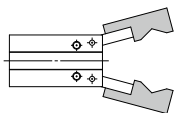
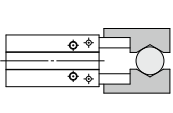
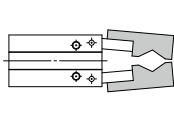
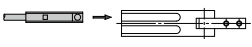
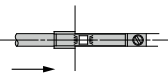
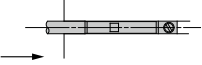
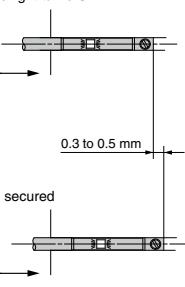
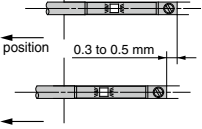
Detection example		1. Confirmation of fingers in reset position	2. Confirmation of workpiece held	3. Confirmation of workpiece released	
Position to be detected		Position of fingers fully opened 	Position when gripping workpiece 	Position of fingers fully closed 	
Operation of auto switch		Auto switch turned on when fingers return. (Light ON)	Auto switch turned on when gripping a workpiece. (Light ON)	When a workpiece is not held (Abnormal operation): Auto switch to turn ON (Light ON)	
Detection combinations	One auto switch + One position, any of ①, ② and ③ can be detected.	●	●	●	
	Two auto switches + Two positions of ①, ② and ③ can be detected.	Pattern A	●	—	
		Pattern B	—	●	●
Pattern C	●	—	●		
How to determine auto switch installation position		Step 1) Fully open the fingers. 	Step 1) Position fingers for gripping a workpiece. 	Step 1) Fully close the fingers. 	
At no pressure or low pressure, connect the auto switch to a power supply, and follow the directions.		Step 2) Insert the auto switch into the auto switch installation groove in the direction shown in the drawing. 			
		Step 3) Slide the auto switch in the direction of the arrow until the indicator light illuminates.	Step 3) Slide the auto switch in the direction of the arrow until the light illuminates and fasten it at a position 0.3 to 0.5 mm in the direction of the arrow beyond the position where the indicator light illuminates.		
			Position where light turns ON		
		Step 4) Slide the auto switch further in the direction of the arrow until the indicator light goes out.			
		Step 5) Move the auto switch in the opposite direction and fasten it at a position 0.3 to 0.5 mm beyond the position where the indicator light illuminates.	Position to be secured		
Position where light turns ON					
Fitting position					

Note 1) It is recommended to grip a workpiece when the fingers are in parallel with each other.

Note 2) When holding a workpiece close at the end of open/close stroke of fingers, detecting performance of the combinations listed in the above table may be limited, depending on the hysteresis of an auto switch, etc.

MHC2-6/MHCA2-6 Series

Auto Switch Hysteresis

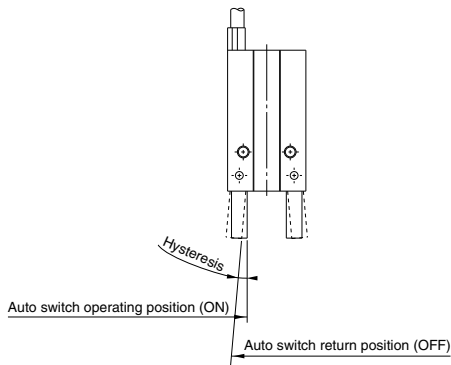

Hysteresis

Model	D-M9□(V), M9□A(V)
MHC2-6□	4°

Auto Switch Mounting

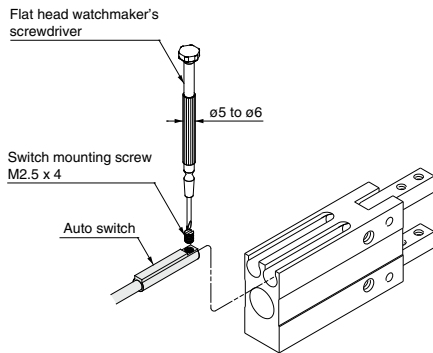

Note) Use a watchmaker's screwdriver with a grip diameter of 5 to 6 mm to tighten the auto switch mounting screw. Also, tighten with a torque of about 0.05 to 0.15 N·m, or about 0.05 to 0.10 N·m for D-M9□A(V).

Protrusion of Auto Switch from Edge of Body

- The amount of auto switch protrusion from the body end surface is shown in the table below.
- Use this as a standard when mounting, etc.

Lead wire type	Illustration	In-line entry		Perpendicular entry	
		D-M9□ M9□W	D-M9□A	D-M9□V M9□WV	D-M9□AV
Air gripper model	Auto switch model				
	Finger position				
MHC2-6□	Open	6.5 mm	8.5 mm	4.5 mm	6.5 mm
	Close	9 mm	11 mm	7 mm	9 mm

Angular Type Air Gripper/Compact Type MHCM2-7S Series

ø7

How to Order

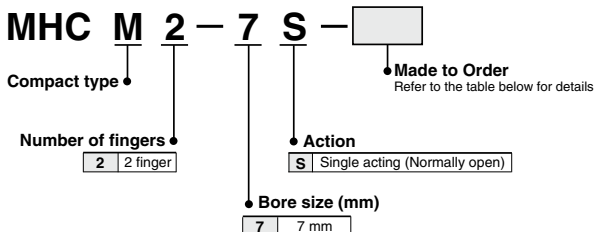

Symbol

Single acting/ Normally open: External grip



Specifications

Fluid	Air
Operating pressure	0.4 to 0.6 MPa
Ambient and fluid temperature	-10 to 60°C
Repeatability	±0.02 mm
Maximum operating frequency	180 c.p.m.
Lubrication	Non-lube
Action	Single acting (Normally open)

Model

Action	Model	Cylinder bore (mm)	Gripping moment ^{Note)} (Effective value) N·m	Opening/Closing angle (Both sides)	Weight (g)
Single acting (Normally open)	MHCM2-7S	7	0.017	20° to -7°	9.5

Note) At the pressure of 0.5 MPa



Made to Order
[Click here for details](#)

Symbol	Specifications/Description
-X4	Heat resistance (100°C)
-X5	Fluororubber seal
-X56	Axial piping type
-X63	Fluorine grease
-X79	Grease for food processing machines, Fluorine grease
-X79A	Grease for food processing machines
-X81A	Anti-corrosive treatment of finger

Moisture Control Tube IDK Series



When operating an actuator with a small diameter and a short stroke at a high frequency, the dew condensation (water droplet) may occur inside the piping depending on the conditions.

Simply connecting the moisture control tube to the actuator will prevent dew condensation from occurring. For details, refer to the [Web Catalog](#).

MHCM2-7S Series

Construction/MHCM2-7S (Compact type)

Single acting/With fingers open

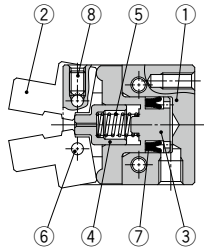

With fingers closed

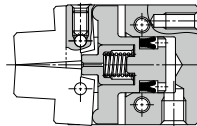

Component Parts

No.	Description	Material	Note	Replacement parts order no.
1	Body	Aluminium alloy	Hard anodized	
2	Finger	Stainless steel	Heat treatment	
3	Piston	Stainless steel	Heat treatment	
4	Pusher	Stainless steel		
5	Spring	Piano wire	Zinc chromated	
6	Needle roller	High carbon chromium bearing steel		
7	Piston seal	NBR		MYN-4
8	Hexagon socket cap screw	Stainless steel		

Dimensions

MHCM2-7S

