

# Air Cylinder

## CG1 Series

ø20, ø25, ø32, ø40, ø50, ø63, ø80, ø100

RoHS

Female rod end available as standard

Rod end types suitable for the application can be selected.

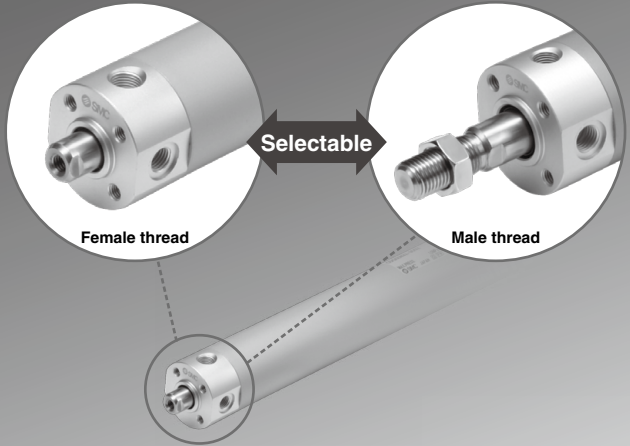

Easy fine adjustment of auto switch position

Fine adjustment of the auto switch position is possible by simply loosening the screw attached to the auto switch.

Transparent switch bracket improves visibility of indicator LED.

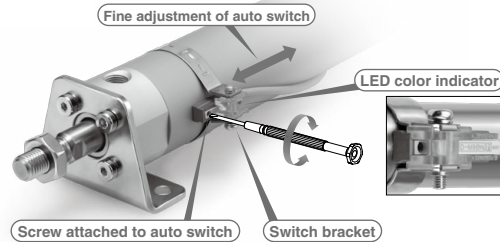

No trunnion mounting female thread added to basic type variation

No foreign matter accumulation due to the simple construction

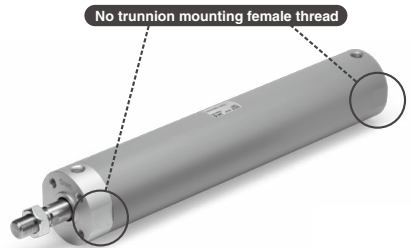

## Part numbers with rod end bracket and/or pivot bracket available

Not necessary to order a bracket for the applicable cylinder separately

(Note) Mounting bracket is shipped together with the product, but not assembled.

Example) CDG1 **D** N20-50Z- **N W** -M9BW  
 • Mounting

Pivot bracket	
Nil	None
N	Pivot bracket is shipped together with the product, but not assembled.



Rod end bracket	
Nil	None
V	Single knuckle joint
W	Double knuckle joint

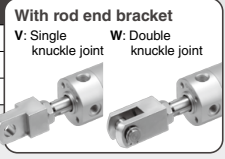

\* Applicable to only mounting D, U and T.

## Various mounting bracket options

- Suitable mounting brackets can be selected for the installation condition.
- Improved amount of mounting freedom

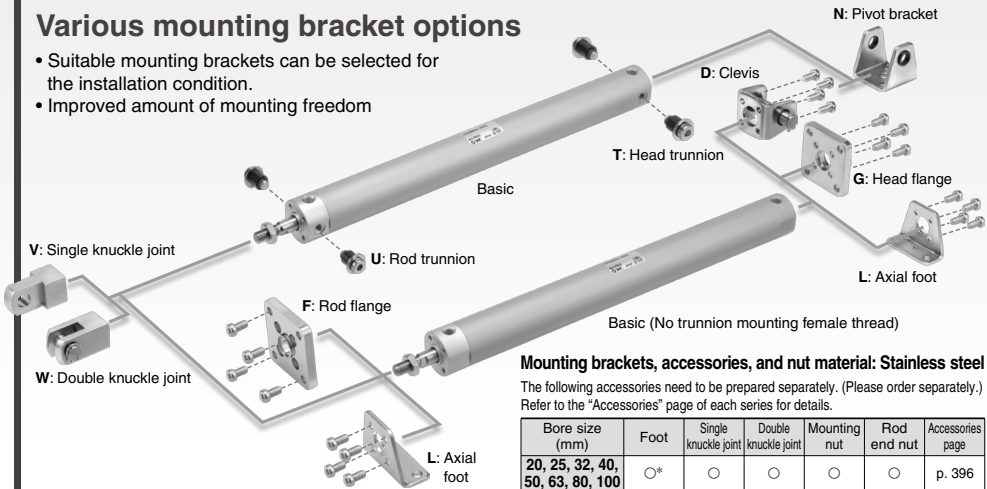

### Mounting brackets, accessories, and nut material: Stainless steel

The following accessories need to be prepared separately. (Please order separately.) Refer to the "Accessories" page of each series for details.

Bore size (mm)	Foot	Single knuckle joint	Double knuckle joint	Mounting nut	Rod end nut	Accessories page
20, 25, 32, 40, 50, 63, 80, 100	○*	○	○	○	○	p. 396

\* Except bore size 20 and 25.

## Easy fine adjustment of auto switch position

Fine adjustment of the auto switch set position can be performed by loosening the auto switch attached screw without loosening the auto switch mounting band. Operability improved compared with the current auto switch set position adjustment, where the complete switch mounting band requires loosening.

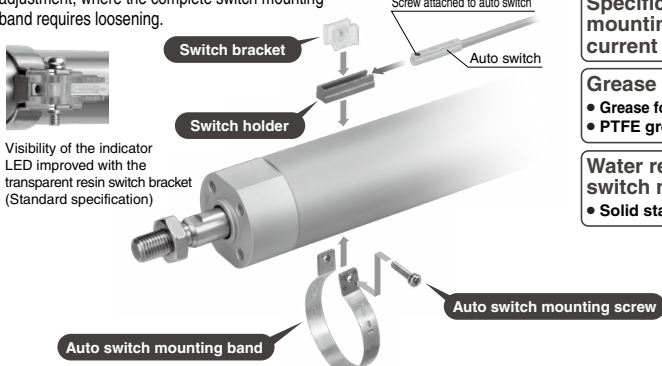

Visibility of the indicator LED improved with the transparent resin switch bracket (Standard specification)

## No environmental hazardous substances used

Compliant with EU RoHS directive. Lead free bushing is used as sliding material.

Specifications, performance and mounting method are same as the current product.







Grease is selectable. (Option)  
 • Grease for food processing equipment (XC85)  
 • PTFE grease (X446)

Water resistant compact auto switch now available  
 • Solid state auto switch D-M9□A(V)

## Stroke Variations

Bore size (mm)	Standard stroke								
	25	50	75	100	125	150	200	250	300
20	●	●	●	●	●	●	●	●	●
25	●	●	●	●	●	●	●	●	●
32	●	●	●	●	●	●	●	●	●
40	●	●	●	●	●	●	●	●	●
50	●	●	●	●	●	●	●	●	●
63	●	●	●	●	●	●	●	●	●
80	●	●	●	●	●	●	●	●	●
100	●	●	●	●	●	●	●	●	●

## Series Variations \* For details about the clean series, refer to the Web Catalog.

Series	Action	Type	Cushion	Bore size (mm)								Variations			Page	
				20	25	32	40	50	63	80	100	With rod boot	Air-hydro	Clean series		
Standard CG1-Z 	Double acting	Single rod	Rubber bumper	●	●	●	●	●	●	●	●	●	●	●	●	Page 378
			Air cushion	●	●	●	●	●	●	●	●	●	●	●	●	
	Double acting	Double rod	Rubber bumper	●	●	●	●	●	●	●	●	●	●	●	●	Page 398
Non-rotating rod CG1K-Z 	Double acting	Single rod	Rubber bumper	●	●	●	●	●	●	●	●	●	●	●	●	Page 413
			Air cushion	●	●	●	●	●	●	●	●	●	●	●	●	●
	Double acting	Double rod	Rubber bumper	●	●	●	●	●	●	●	●	●	●	●	●	Page 418
Direct mount CG1R-Z 	Double acting	Single rod	Rubber bumper	●	●	●	●	●	●	●	●	●	●	●	●	Page 422
			Air cushion	●	●	●	●	●	●	●	●	●	●	●	●	●
Direct mount, Non-rotating rod CG1KR-Z 	Double acting	Single rod	Rubber bumper	●	●	●	●	●	●	●	●	●	●	●	●	Page 427
With end lock CBG1 	Double acting	Single rod	Rubber bumper	●	●	●	●	●	●	●	●	●	●	●	●	Page 431
			Air cushion	●	●	●	●	●	●	●	●	●	●	●	●	●
Smooth Cylinder CG1Y-Z 	Double acting	Single rod	Rubber bumper	●	●	●	●	●	●	●	●	●	●	●	●	Web Catalog
CG3 series																
Short type, Standard CG3 	Double acting	Single rod	Rubber bumper	●	●	●	●	●	●	●	●	●	●	●	●	Page 451

## Environmentally Resistant Specifications

### Water Resistant ■ Corrosion Resistant

Stainless steel cylinder (CG5 Series) ..... p. 1117

### Water Resistant

The use of a special scraper allows for improved water resistance.

Water-resistant cylinder (CG1□R/V) ..... p. 1192

### Corrosion Resistant

Fluororubber seal (-XC22) ..... p. 1508

### Dust Resistant

Durability is 4 times stronger than the standard model.

Compact cylinder with stable lubrication function (Lube-retainer) (CG1□M) ..... p. 1201

Prevents dust, etc., adhered to the rod from entering the internal parts

With heavy duty scraper (-XC4) ..... p. 1459

### Spatter Resistant

With coil scraper (-XC35) ..... p. 1520

### Temperature Measures

Heat resistant/Cold resistant cylinder (-XB6, -XB7) ..... p. 1428, 1430

Refer to "Operating Environment" in the Actuator Precautions.

## Applications Requiring Lateral Load Resistance

For use in applications in which a lateral load exceeding the allowable value is to be applied, consider using a guide cylinder.

# Combinations of Standard Products and Made to Order Specifications

## CG1 Series

●	: Standard
◎	: Made to Order
○	: Special product (Please contact SMC for details.)
—	: Not available

Symbol	Specifications	Applicable bore size	CG1 (Standard type)				CG1K (Non-rotating rod type)					
			Double acting		Single acting		Double acting					
			Single rod		Double rod		Single rod		Single rod		Double rod	
			Rubber	Air	Rubber	Air	Rubber	Rubber	Air	Rubber		
			Page 378	Page 398	Page 406	Page 413	Page 418					
		ø20 to ø100	●	●	●	●	●	●	●	●		
Long st	Long stroke	ø20 to ø100	●	●	●	●	○	● <sup>Note 13</sup>	● <sup>Note 13</sup>	● <sup>Note 13</sup>		
D	Built-in magnet		●	●	●	●	●	●	●	●		
CG1□F	With One-touch fittings <sup>Note 15)</sup>	ø20 to ø63	●	○	○	○	○	○	○	○		
CG1□-□ <sub>k</sub>	With rod boot	ø20 to ø100	● <sup>Note 11)</sup>	● <sup>Note 11)</sup>	● <sup>Note 11)</sup>	● <sup>Note 11)</sup>	○	○	○	○		
CG1□H	Air-hydro type	ø20 to ø63	●	—	●	—	—	—	—	—		
10-, 11-	Clean series	ø20 to ø100	●	● <sup>Note 1)</sup>	●	● <sup>Note 1)</sup>	○	—	—	—		
25A- <sup>Note 9)</sup>	Copper (Cu) and Zinc (Zn) restrictions	ø20 to ø100	●	●	○	○	○	○	○	○		
20- <sup>Note 9)</sup>	Copper <sup>Note 8)</sup> and Fluorine-free	ø20 to ø100	●	●	●	●	○	●	○	●		
CG1□ <sup>R</sup>	Water resistant	ø32 to ø100	●	●	●	●	○	—	—	—		
CG1□M	Cylinder with stable lubrication function (Lube-retainer)	ø20 to ø100	●	○	○	○	—	—	—	—		
XB6	Heat resistant cylinder (-10 to 150°C) <sup>Note 7)</sup>	ø20 to ø100	◎ <sup>Note 2)</sup>	◎	◎ <sup>Note 2)</sup>	◎	○	—	—	—		
XB7	Cold resistant cylinder (-40 to 70°C) <sup>Note 7)</sup>		◎ <sup>Note 2)</sup>	○	◎ <sup>Note 2)</sup> ◎ <sup>Note 5)</sup>	○	○	—	—	—		
XB9	Low speed cylinder (10 to 50 mm/s)		◎	○	○	○	—	—	—	—		
XB13	Low speed cylinder (5 to 50 mm/s)		◎	○	○	○	—	—	—	—		
XC4	With heavy duty scraper	ø32 to ø63	◎	◎	◎	◎	○	—	—	—		
XC6	Made of stainless steel	ø20 to ø100	◎	◎	◎	◎	◎	—	—	—		
XC8	Adjustable stroke cylinder/Adjustable extension type	ø20 to ø63	◎	◎	—	—	○	◎	○	—		
XC9	Adjustable stroke cylinder/Adjustable retraction type		◎	◎	—	—	○	◎	○	—		
XC10	Dual stroke cylinder/Double rod type		◎	◎	—	—	○	◎	◎	—		
XC11	Dual stroke cylinder/Single rod type		◎	◎	—	—	—	◎	○	—		
XC12	Tandem cylinder		◎	◎	—	—	—	◎	○	○		
XC13	Auto switch rail mounting		ø20 to ø100	◎	◎	◎	◎	◎	○	○		
XC20	Head cover axial port	ø20 to ø63	◎	○	—	—	◎	○	○			
XC22	Fluororubber seal		◎ <sup>Note 2)</sup>	◎	◎ <sup>Note 2)</sup>	◎	○	○	○			
XC27	Double clevis and double knuckle joint pins made of stainless steel	ø20 to ø100	◎	◎	○	○	◎	◎	◎	○		
XC29	Double knuckle joint with spring pin		◎	◎	○	○	◎ <sup>Note 6)</sup>	○	○	○		
XC35	With coil scraper		◎	◎	○	○	○	—	—	—		
XC37	Larger throttle diameter of connection port	ø20 to ø63	◎	◎	◎	◎	◎	○	○	○		
XC42	Built-in shock absorber in head cover side		◎	◎	—	—	○	○	○	—		
XC85	Grease for food processing equipment	ø20 to ø100	◎	◎	◎	◎	◎	○	○	○		
X446	PTFE grease	ø20 to ø100	◎	◎	◎	◎	◎	○	○	○		

Note 1) ø40 to ø63 only  
 Note 2) Without bumper  
 Note 3) ø32 to ø100 only  
 Note 4) SV type only (Heat resistant grease is used.)  
 Note 5) ø20 to ø63 only  
 Note 6) Single acting/spring return type (S) only  
 Note 7) The products with an auto switch are not compatible.

CG1R (Direct mount type)		CG1KR (Direct mount, Non-rotating rod type)		CBG1 <sup>Note 15)</sup> (With end lock)		CG1□Y <sup>Note 12)</sup> (Smooth Cylinder)		
Double acting		Double acting		Double acting		Double acting		
Single rod		Single rod		Single rod		Single rod		
Rubber	Air	Rubber	Rubber	Air	—			
Page 422		Page 427		Page 431		Web Catalog		
ø20 to ø63		ø20 to ø63		ø20 to ø100		ø20 to ø100		Symbol
●	●	●	●	●	●	●	●	Standard
○	○	○	●	●	● <sup>Note 10)</sup>	○	○	Long st
●	●	●	●	●	●	○	○	D
○	○	○	○	○	○	○	○	CG1□F
○	○	○	●	●	○	○	○	CG1□-□ <sub>k</sub>
○	—	—	—	—	—	—	—	CG1□H
●	○	—	○	○	—	—	—	10-, 11-
○	○	○	○	○	○	○	○	25A- <sup>Note 9)</sup>
●	●	○	○	○	○	—	—	20- <sup>Note 9)</sup>
○	○	—	○	○	○	—	—	CG1□ <sup>R</sup>
○	○	—	—	—	—	—	—	CG1□M
◎ <sup>Note 2)</sup>	◎	—	○	○	—	—	—	XB6
◎ <sup>Note 2)</sup>	○	—	—	—	—	—	—	XB7
◎	○	—	○	○	—	—	—	XB9
◎	○	—	—	—	—	—	—	XB13
○	○	—	○	○	—	—	—	XC4
◎	◎	—	○	○	○	◎	◎	XC6
◎	○	◎	○ <sup>Note 13)</sup>	○ <sup>Note 13)</sup>	○	○	○	XC8
◎	○	◎	○ <sup>Note 14)</sup>	○ <sup>Note 14)</sup>	○	○	○	XC9
○	○	○	○	○	○	○	○	XC10
○	○	○	○	○	○	○	○	XC11
○	○	○	○	○	○	—	—	XC12
◎	○	○	◎	◎	○	○	○	XC13
◎	○	◎	○	○	○	◎	◎	XC20
◎ <sup>Note 2)</sup>	◎	○	○	○	○	—	—	XC22
○	○	○	○	○	○	◎	◎	XC27
○	○	○	○	○	○	○	○	XC29
○	○	—	○	○	○	—	—	XC35
○	○	○	○	○	○	○	○	XC37
○	○	○	○	○	○	—	—	XC42
◎	◎	○	○	○	○	—	—	XC85
◎	◎	—	—	—	—	—	—	X446

Note 8) Copper-free for the externally exposed part. For details, refer to the **Web Catalog**.

Note 9) For details, refer to the **Web Catalog**.

Note 10) Long stroke is beyond the performance guarantee.

Note 11) Female rod end is available as a special order.

Note 12) For details about the smooth cylinder, refer to the **Web Catalog**.

Note 13) Available only for locking at head end.

Note 14) Available only for locking at rod end.

Note 15) The shape is the same as the current product.

# Air Cylinder: Standard Type Double Acting, Single Rod

## CG1 Series

ø20, ø25, ø32, ø40, ø50, ø63, ø80, ø100

RoHS

### How to Order



CG1 **B** **N** **20** **100** **Z** **---** **---** **---**

With auto switch

CDG1 **B** **N** **20** **100** **Z** **---** **---** **---** **M9BW** **---** **---**

With auto switch  
(Built-in magnet)

#### Mounting

<b>B</b>	Basic
<b>Z*</b>	Basic (without trunnion mounting female thread)
<b>L</b>	Axial foot
<b>F</b>	Rod flange
<b>G</b>	Head flange
<b>U*</b>	Rod trunnion
<b>T*</b>	Head trunnion
<b>D</b>	Clevis

- \* Not available for ø80 and ø100.
- \* Mounting bracket is shipped together with the product, but not assembled.
- \* The cylinder for F, G, L, D mounting types is Z: Basic (without trunnion mounting female thread).

#### Bore size

<b>20</b>	20 mm
<b>25</b>	25 mm
<b>32</b>	32 mm
<b>40</b>	40 mm
<b>50</b>	50 mm
<b>63</b>	63 mm
<b>80</b>	80 mm
<b>100</b>	100 mm

#### Type

<b>N</b>	Rubber bumper
<b>A</b>	Air cushion

#### Port thread type

Rubber bumper			Air cushion		
<b>Nil</b>	Rc	ø20 to ø100	M5 x 0.8	Rc	ø20, ø25
<b>TN</b>	NPT	ø20 to ø100	NPT*	Rc	ø32 to ø100
<b>TF</b>	M5 x 0.8	ø20, ø25	G*	Rc	ø32 to ø100
	G	ø32 to ø100			

\* Not available for ø20 and ø25.

#### Pivot bracket

<b>Nil</b>	None
<b>N</b>	Pivot bracket is shipped together with the product, but not assembled

- \* Only for D, U, T mounting types
- \* Pivot bracket is shipped together with the product, but not assembled.

#### Rod end bracket

<b>Nil</b>	None
<b>V</b>	Single knuckle joint
<b>W</b>	Double knuckle joint

- \* No bracket is provided for the female rod end.
- \* Rod end bracket is shipped together with the product, but not assembled.
- \* A knuckle joint pin is not provided with the single knuckle joint.

#### Made to Order

For details, refer to page 379.

#### Number of auto switches

<b>Nil</b>	2 pcs.
<b>S</b>	1 pc.
<b>n</b>	"n" pcs.

#### Auto switch

<b>Nil</b>	Without auto switch
------------	---------------------

- \* For applicable auto switches, refer to the table below.

#### Suffix for cylinder (Rod boot)

<b>Nil</b>	Without rod boot
<b>J</b>	Nylon tarpaulin
<b>K</b>	Heat resistant tarpaulin

- \* In the case of rod boot, and a foot bracket or rod flange as a bracket, those parts are to be assembled at the time of shipment.
- \* For female rod end, no rod boot is provided.

#### Rod end thread

<b>Nil</b>	Male rod end
<b>F</b>	Female rod end

#### Cylinder stroke (mm)

Refer to "Standard Strokes" on page 379.

\* Refer to "Ordering Example of Cylinder Assembly" on page 380.

### Applicable Auto Switches/Refer to pages 1271 to 1365 for further information on auto switches.

Type	Special function	Electrical entry	Indicator light	Wiring (Output)	Load voltage		Auto switch model			Lead wire length (m)	Pre-wired connector	Applicable load													
					DC	AC	Applicable bore size																		
							ø20 to ø63	ø80, ø100	0.5 (Nil)				1 (M)	3 (L)	5 (Z)	None (N)									
Solid state auto switch	Diagnostic indication (2-color indicator)	Grommet	Yes	3-wire (NPN)	24 V	5 V, 12 V	—	Perpendicular	In-line	In-line	●	●	●	●	○	IC circuit									
				M9NV				M9N	G59	●	●	●	●	○											
				M9PV				M9P	G5P	●	●	●	●	○											
		M9BV		M9B				K59	●	●	●	●	○												
		—		H7C				—	●	—	—	●	—												
		M9NVW		M9NW				G59W	●	●	●	●	○												
	Water resistant (2-color indicator)	Connector	Grommet	3-wire (NPN)	24 V	5 V, 12 V	—	—	Perpendicular	In-line	In-line	●	●	●	●		○								
				M9PWV					M9PW	G5PW	●	●	●	●	○										
				M9BWV					M9BW	K59W	●	●	●	●	○										
				M9NAV <sup>ø1</sup>					M9NA <sup>ø1</sup>	—	○	○	○	○	○										
With diagnostic output (2-color indicator)	Grommet	Yes	3-wire (PNP)	24 V	5 V, 12 V	—	—	Perpendicular	In-line	In-line	○	○	○	○	○										
			M9PAV <sup>ø1</sup>					M9PA <sup>ø1</sup>	—	○	○	○	○	○											
Reed auto switch	Diagnostic indication (2-color indicator)	Grommet	Yes	3-wire (NPN)	24 V	12 V	—	—	—	—	—	—	—	—	—	IC circuit									
				A96V													A96	—	●	●	●	●	○		
				A93V <sup>ø2</sup>													A93	—	●	●	●	●	○		
		A90V		A90													—	●	●	●	●	○			
		—		B54													—	●	●	●	●	○			
		—		B64													—	●	●	●	●	○			
	Connector	Grommet	Yes	2-wire	24 V	12 V	—	—	—	—	—	—	—	—	—		—								
																		—	C73C	—	●	●	●	●	○
																		—	C80C	—	●	●	●	●	○
																		—	B59W	—	●	●	●	●	○

- \* 1 Water resistant type auto switches can be mounted on the above models, but in such case SMC cannot guarantee water resistance.
- \* A water-resistant type cylinder is recommended for use in an environment which requires water resistance. However, please contact SMC for water-resistant cylinder of ø20 and ø25.
- \* 2 1 m type lead wire is only applicable to D-A93.
- \* Lead wire length symbols: 0.5 m..... Nil (Example) M9NW 5 m..... Z (Example) M9NWZ
- 1 m..... M (Example) M9NWMM None..... N (Example) H7CN
- 3 m..... L (Example) M9NWL
- \* Solid state auto switches marked with "○" are produced upon receipt of order.
- \* Since there are other applicable auto switches than listed above, refer to page 446 for details.
- \* For details about auto switches with pre-wired connector, refer to pages 1340 and 1341.
- \* The D-A93□□/M9□□□ auto switches are shipped together, (but not assembled). (However, only the auto switch mounting brackets are assembled before shipment.)

## Specifications



### Symbol

Rubber bumper

Air cushion

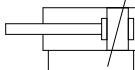
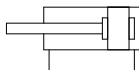

**Made to Order: Individual Specifications**  
(For details, refer to page 447.)

Symbol	Specifications
-X446	PTFE grease

### Made to Order

[Click here for details](#)

Symbol	Specifications
-XA□	Change of rod end shape
-XB6	Heat resistant cylinder (-10 to 150°C)*1
-XB7	Cold resistant cylinder (-40 to 70°C)*2
-XB9	Low speed cylinder (10 to 50 mm/s)
-XB13	Low speed cylinder (5 to 50 mm/s)
-XC4	With heavy duty scraper
-XC6	Made of stainless steel
-XC8	Adjustable stroke cylinder/Adjustable extension type
-XC9	Adjustable stroke cylinder/Adjustable retraction type
-XC10	Dual stroke cylinder/Double rod type
-XC11	Dual stroke cylinder/Single rod type
-XC12	Tandem cylinder
-XC13	Auto switch rail mounting
-XC20	Head cover axial port
-XC22	Fluororubber seal*1
-XC27	Double clevis and double knuckle joint pins made of stainless steel
-XC29	Double knuckle joint with spring pin
-XC35	With coil scraper
-XC37	Larger throttle diameter of connection port
-XC42	Built-in shock absorber in head cover side
-XC85	Grease for food processing equipment

\*1 Cylinders with rubber bumper have no bumper.

\*2 Only compatible with cylinders with rubber bumper, but has no bumper.

Refer to pages 440 to 446 for cylinders with auto switches.
<ul style="list-style-type: none"> <li>• Auto switch proper mounting position (detection at stroke end) and its mounting height</li> <li>• Minimum stroke for auto switch mounting</li> <li>• Auto switch mounting brackets/Part no.</li> <li>• Operating range</li> <li>• Cylinder mounting bracket, by stroke/Auto switch mounting surfaces</li> </ul>



## Precautions

Refer to page 448 before handling.

Bore size (mm)		20	25	32	40	50	63	80	100	
<b>Action</b>		Double acting, Single rod								
<b>Lubricant</b>		Not required (Non-lube)								
<b>Fluid</b>		Air								
<b>Proof pressure</b>		1.5 MPa								
<b>Maximum operating pressure</b>		1.0 MPa								
<b>Minimum operating pressure</b>		0.05 MPa								
<b>Ambient and fluid temperature</b>		Without auto switch: -10°C to 70°C (No freezing) With auto switch: -10°C to 60°C								
<b>Piston speed</b>		50 to 1000 mm/s							50 to 700 mm/s	
<b>Stroke length tolerance</b>		Up to 1000 st <sup>+1,4</sup> / <sub>0</sub> mm, Up to 1500 st <sup>+1,8</sup> / <sub>0</sub> mm								
<b>Cushion</b>		Rubber bumper, Air cushion								
<b>Mounting**</b>		Basic, Basic (without trunnion mounting female thread), Axial foot, Rod flange, Head flange, Rod trunnion, Head trunnion, Clevis								
<b>Allowable kinetic energy (J)</b>	<b>Rubber bumper</b>	<b>Male rod end</b>	0.28	0.41	0.66	1.20	2.00	3.40	5.90	9.90
		<b>Female rod end</b>	0.11	0.18	0.29	0.52	0.91	1.54	2.71	4.54
	<b>Air cushion</b>	<b>Male rod end</b>	R: 0.35 H: 0.42	R: 0.56 H: 0.65	0.91	1.80	3.40	4.90	11.80	16.70
		<b>Female rod end</b>	0.11	0.18	0.29	0.52	0.91	1.54	2.71	4.54

\* R: Rod side, H: Head side

\*\* Cylinder sizes ø80 and ø100 do not have basic (without trunnion mounting female thread), rod trunnion and head trunnion types. Foot, flange and clevis types of cylinder sizes from ø20 to ø63 do not have trunnion mounting female thread. Operate the cylinder within the allowable kinetic energy.

## Accessories

Refer to page 395 for part numbers and dimensions.

Mounting		Basic	Axial foot	Rod flange	Head flange	Rod trunnion	Head trunnion	Clevis
Standard	Rod end nut	●	●	●	●	●	●	●
	Clevis pin	—	—	—	—	—	—	●
Option	Single knuckle joint	●	●	●	●	●	●	●
	Double knuckle joint (with pin)*2	●	●	●	●	●	●	●
	Pivot bracket*1	—	—	—	—	●*3	●*3	●
	Rod boot	●	●	●	●	●	●	●

\*1 Not available for ø80 and ø100.

\*2 A double knuckle joint pin and retaining rings are shipped together.

\*3 Stainless steel mounting brackets and accessories are also available.

Refer to page 396 for details.

## Standard Strokes

Bore size	Standard stroke <sup>Notes1)</sup>	Manufacturable stroke (mm)
20	25, 50, 75, 100, 125, 150, 200	1 to 1500
25		
32		
40	25, 50, 75, 100, 125,	1 to 1500
50, 63	150, 200, 250, 300	
80		
100		

Note 1) Intermediate strokes not listed above are produced upon receipt of order. Manufacture of intermediate strokes at 1 mm intervals is possible. (Spacers are not used.)

Note 2) Applicable strokes should be confirmed according to the usage. For details, refer to "Air Cylinders Model Selection" on pages 8 to 19. In addition, the products that exceed the standard stroke might not be able to fulfill the specifications due to the deflection etc.

# CG1 Series

## Ordering Example of Cylinder Assembly

Cylinder model: **CDG1DN20-100Z-NW-M9BW**

Mounting	D: Clevis
Pivot bracket	N: Yes
Rod end bracket	W: Double knuckle joint
Auto switch D-M9BW:	2 pcs.

\*Pivot bracket, double knuckle joint and auto switch are shipped together with the product, but not assembled.

## Rod Boot Material

Symbol	Rod boot material	Maximum operating temperature
<b>J</b>	Nylon tarpaulin	70°C
<b>K</b>	Heat resistant tarpaulin	110°C*

\* Maximum ambient temperature for the rod boot itself.

## Mounting Brackets/Part No.

Mounting bracket	Order qty	Bore size (mm)								Contents
		20	25	32	40	50	63	80	100	
Axial foot	2 (Note)	CG-L020	CG-L025	CG-L032	CG-L040	CG-L050	CG-L063	CG-L080	CG-L100	2 feet, 8 mounting bolts
Flange	1	CG-F020	CG-F025	CG-F032	CG-F040	CG-F050	CG-F063	CG-F080	CG-F100	1 flange, 4 mounting bolts
Trunnion pin	1	CG-T020	CG-T025	CG-T032	CG-T040	CG-T050	CG-T063	—	—	2 trunnion pins, 2 trunnion bolts, 2 flat washers
Clevis	1	CG-D020	CG-D025	CG-D032	CG-D040	CG-D050	CG-D063	CG-D080	CG-D100	1 clevis, 4 mounting bolts, 1 clevis pin, 2 retaining rings
Pivot bracket	1	CG-020-24A	CG-025-24A	CG-032-24A	CG-040-24A	CG-050-24A	CG-063-24A	CG-080-24A	CG-100-24A	1 pivot bracket

Note) Order two feet per cylinder.

## Mounting Brackets, Accessories/Material, Surface Treatment

Segment	Description	Material	Surface treatment
Mounting brackets	Foot	Carbon steel	Nickel plating
	Flange	Carbon steel (ø20 to ø63)	Nickel plating
		Cast iron (ø80, ø100)	Nickel plating
	Clevis	Carbon steel (ø20 to ø63)	Nickel plating
		Cast iron (ø80, ø100)	Nickel plating
	Trunnion pin	Trunnion pin	Carbon steel
Trunnion bolt		Carbon steel	Nickel plating
Flat washer		Carbon steel	Nickel plating
Accessories	Rod end nut	Carbon steel	Zinc chromated
	Single knuckle joint	Carbon steel (ø20 to ø32)	Nickel plating
		Cast iron (ø40 to ø100)	Zinc chromated
	Double knuckle joint	Carbon steel (ø20 to ø32)	Nickel plating
		Cast iron (ø40 to ø100)	Zinc chromated
	Knuckle pin	Carbon steel	—
	Clevis pin	Carbon steel	—
	Pivot bracket	Carbon steel (ø20 to ø63)	Nickel plating
		Cast iron (ø80, ø100)	Nickel plating
	Mounting bolt	Carbon steel	Nickel plating
Retaining ring	Carbon tool steel	Phosphate coating	

## Mounting Procedure

### Mounting procedure for trunnion

Follow the procedures below when mounting a pivot bracket on the trunnion.

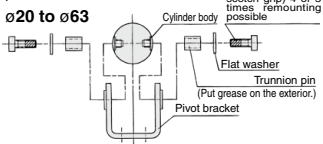

### Mounting procedure for clevis

Follow the procedures below when mounting a pivot bracket on the clevis.

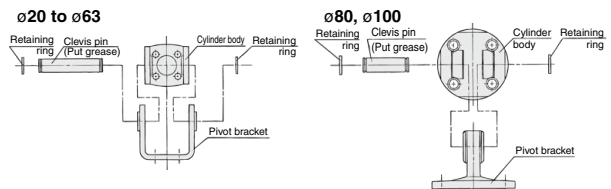



## Weights

		(kg)							
Bore size (mm)		20	25	32	40	50	63	80	100
Basic weight	Basic (B)	0.11	0.17	0.24	0.44	0.79	1.06	2.07	3.16
	Basic (Z)	0.11	0.17	0.25	0.45	0.80	1.09	—	—
	Axial foot	0.21	0.29	0.40	0.67	1.26	1.77	3.04	4.91
	Flange	0.18	0.26	0.38	0.65	1.16	1.64	2.78	4.44
	Trunnion	0.12	0.19	0.28	0.49	0.88	1.20	—	—
	Clevis	0.17	0.25	0.39	0.68	1.19	1.78	2.77	4.44
Pivot bracket		0.08	0.09	0.17	0.25	0.44	0.80	0.98	1.75
Single knuckle joint		0.05	0.09	0.09	0.10	0.22	0.22	0.39	0.57
Double knuckle joint (with pin)		0.05	0.09	0.09	0.13	0.26	0.26	0.64	1.31
Additional weight per 50 mm of stroke		0.05	0.07	0.09	0.14	0.21	0.25	0.35	0.50
Additional weight for switch magnet		0.01	0.01	0.01	0.01	0.01	0.02	0.02	0.04
Additional weight with air cushion		0	0.01	0.04	0	0.01	0.04	0	0.04
Weight reduction for female rod end		-0.01	-0.02	-0.02	-0.05	-0.10	-0.10	-0.19	-0.27
Additional weight for long stroke		0.01	0.01	0.02	0.03	0.06	0.12	0.21	0.31

Calculation (Example) **CDG1FN20-100Z**  
(Built-in magnet, Flange, ø20, 100 stroke)

- Basic weight ..... 0.18 kg (Flange, ø20)
  - Additional weight for stroke ..... 0.05 kg/50 mm
  - Air cylinder stroke ..... 100 mm
  - Additional weight for switch magnet ..... 0.01 kg
- $0.18 + 0.05 \times (100/50) + 0.01 = \mathbf{0.29 \text{ kg}}$

## Built-in One-touch Fittings (The shape is the same as the current product.)

**CG1** Mounting type **N** Bore size **F** - Stroke

↓ Built-in One-touch fittings

This type has the One-touch fittings integrated in a cylinder, which enables to reduce the piping labor and installing space dramatically.

## Dimensions (Dimensions other than those shown below are the same as the standard type.)

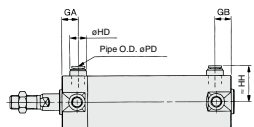

Bore size (mm)	GA	GB	HD	HH	PD
20	12	12	13	24.2	6
25	12	10 (12)	13	26.7	6
32	12	10 (12)	13	30.2	6
40	12	10 (12)	16	34.6	8
50	13	13	20	40.6	10
63	13	13	20	47.1	10

Note ( ) : Long stroke

## Specifications

Bore size (mm)	20, 25, 32, 40, 50, 63
<b>Action</b>	Double acting
<b>Fluid</b>	Air
<b>Maximum operating pressure</b>	1.0 MPa
<b>Minimum operating pressure</b>	0.05 MPa
<b>Piston speed</b>	50 to 750 mm/s
<b>Cushion</b>	Rubber bumper
<b>Mounting</b>	Basic, Axial foot, Rod flange, Head flange, Rod trunnion, Head trunnion, Clevis (used for changing the port location by 90°)

- \* Auto switch can be mounted.
- \* Female rod end is not available.
- \* Use the current seal kit.

## Applicable Tubing O.D./I.D.

Bore size (mm)	20	25	32	40	50	63
Applicable tubing O.D. (mm)	6/4	6/4	6/4	8/6	10/7.5	10/7.5
Applicable tubing material	Can be used for either nylon, soft nylon or polyurethane tubing.					

## Clean Series

**10-CG1** Mounting type Type (Cushion) Bore size - Stroke Rod end thread **Z**

↓ Clean Series (With relief port)

The type which is applicable for using inside the clean room graded ISO Class 4 by making an actuator's rod section a double seal construction and discharging by relief port directly to the outside of clean room.

For details about the clean series, refer to the **Web Catalog**.

## Specifications

Bore size (mm)	20, 25, 32, 40, 50, 63, 80, 100
<b>Action</b>	Double acting
<b>Fluid</b>	Air
<b>Maximum operating pressure</b>	1.0 MPa
<b>Minimum operating pressure</b>	0.05 MPa
<b>Cushion</b>	Rubber bumper, Air cushion
<b>Piston speed</b>	30 to 400 mm/s
<b>Relief port size</b>	M5 x 0.8
<b>Mounting</b>	Basic, Axial foot, Rod flange, Head flange**

- \* Auto switch can be mounted.
- \*\* The basic type is B type only. However, no trunnion mounting female thread is provided.

# CG1 Series

## Air-hydro

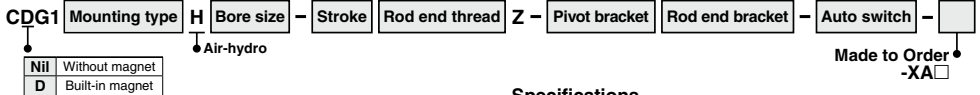

Low pressure hydraulic cylinder of 1.0 MPa or less  
 When using together with the CC series air-hydro unit, constant and low speed actuation and intermediate stopping similar to hydraulic units are possible with the use of valves and other pneumatic equipment.

**Dimensions** (Dimensions other than those shown below are the same as the standard type.)

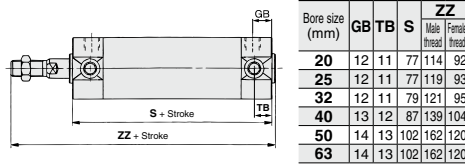

## Specifications

Bore size (mm)	20, 25, 32, 40, 50, 63
<b>Action</b>	Double acting
<b>Fluid</b>	Turbine oil
<b>Proof pressure</b>	1.5 MPa
<b>Maximum operating pressure</b>	1.0 MPa
<b>Minimum operating pressure</b>	0.18 MPa
<b>Piston speed</b>	15 to 300 mm/s
<b>Cushion</b>	Rubber bumper (Standard equipment)
<b>Ambient and fluid temperature</b>	5 to 60°C
<b>Mounting</b>	Basic, Axial foot, Rod flange, Head flange, Rod trunnion, Head trunnion, Clevis
<b>Made to Order</b>	Change of rod end shape

\* Auto switch can be mounted.

## Water Resistant

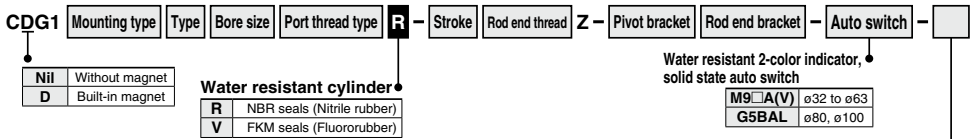

## Caution

Since the scraper is press-fit into the rod cover, it cannot be replaced.

Applicable for use in an environment with water splashing such as food processing and car wash equipment, etc.

## Specifications

Bore size (mm)	32, 40, 50, 63, 80, 100
<b>Action</b>	Double acting, Single rod
<b>Cushion</b>	Rubber bumper/Air cushion
<b>Auto switch mounting</b>	Band mounting type
<b>Made to Order</b>	XC6: Made of stainless steel

\* Specifications other than above are the same as standard type.

**Dimensions** (Dimensions other than those shown below are the same as the standard type.)

### With rubber bumper

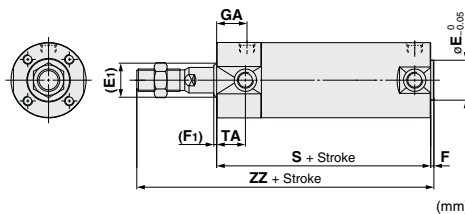

Bore size	(E1)	E*	(F1)	F*	GA			S	TA	WA	ZZ	
					Rc	NPT	G				Male thread	Female thread
32	17	18	2	2	18	16.5	77 (85)	17	22	119 (127)	93 (101)	
40	21	25	2	2	19	19	84 (93)	18	23	136 (145)	101 (110)	
50	26	30	2	2	21	21	97 (109)	20	25	157 (169)	115 (127)	
63	26	32	2	2	21	21	97 (109)	20	25	157 (169)	115 (127)	
80	32	40	3	3	28	25.5	116 (130)	—	32	190 (204)	138 (152)	
100	37	50	3	3	29	26.5	117 (131)	—	33	191 (205)	142 (156)	

\* Dimensions marked with "\*" are the same as the standard type.

\* ( ) : Denotes the dimensions for long stroke.

### With air cushion

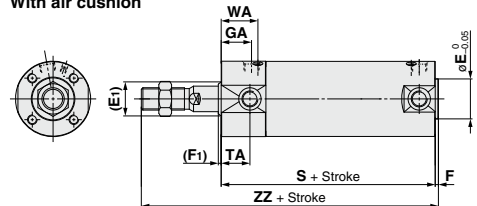

Refer to page 1189 for details.

**Cylinder with Stable Lubrication Function (Lube-retainer)**

CDG1 Mounting N Bore size M - Stroke Rod end thread Z - Pivot bracket Rod end bracket - Auto switch

• With auto switch  
(Built-in magnet)

• Cylinder with Stable Lubrication Function  
(Lube-retainer)



**Specifications**

Bore size (mm)	<b>20, 25, 32, 40, 50, 63, 80, 100</b>
Action	Double acting, Single rod
Minimum operating pressure	0.1 MPa
Cushion	Rubber bumper

\* Specifications other than the above are the same as the standard type.

**Dimensions** (Dimensions other than those shown below are the same as the standard type.)

\* No trunnion mounting female thread is provided on the rod side. (For B: Basic)

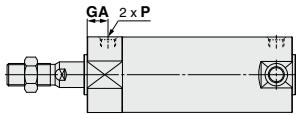

Refer to the **Web Catalog** for details.

(mm)		
Bore size	GA	P
<b>20</b>	14	M5 x 0.8
<b>25</b>	13	M5 x 0.8
<b>32</b>	(12)	(Rc 1/8)
<b>40</b>	(13)	(Rc 1/8)
<b>50</b>	(14)	(Rc 1/4)
<b>63</b>	(14)	(Rc 1/4)
<b>80</b>	(20)	(Rc 3/8)
<b>100</b>	(20)	(Rc 1/2)

\* When female thread is used, use a washer, etc. to prevent the contact part at the rod end from being deformed depending on the material of the workpiece.

( ): Same as the standard model.

\* The mounting dimensions of the mounting bracket are the same as the standard type.

# CG1 Series

## Construction

### With rubber bumper

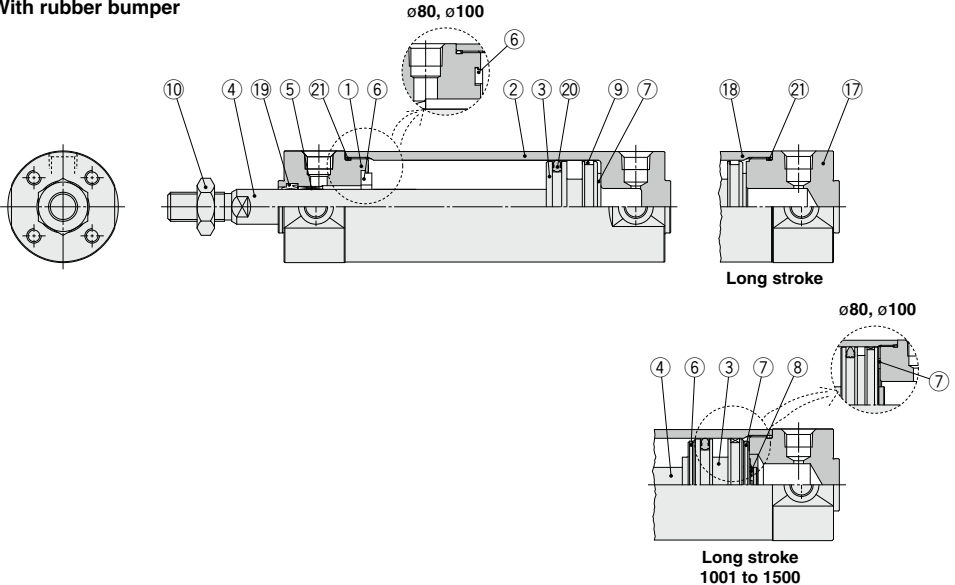

### With air cushion

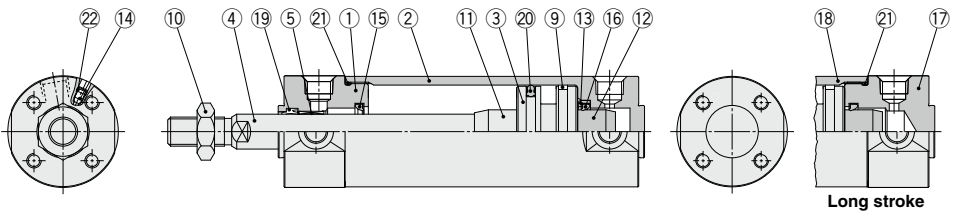

### Component Parts

No.	Description	Material	Note
1	Rod cover	Aluminum alloy	Anodized
2	Tube cover	Aluminum alloy	Hard anodized
3	Piston	Aluminum alloy	
4	Piston rod	Stainless steel	For ø20 or ø25 with built-in magnet
		Carbon steel <sup>*</sup>	Hard chrome plating <sup>*</sup>
5	Bushing	Bearing alloy	
6	Bumper	Resin	ø32 or larger is common.
7	Bumper	Resin	
8	Retaining ring	Stainless steel	Except ø80 and ø100
9	Wear ring	Resin	
10	Rod end nut	Carbon steel	Zinc chromated
11	Cushion ring A	Aluminum alloy	
12	Cushion ring B	Aluminum alloy	
13	Seal retainer	Rolled steel	Zinc chromated
14	Cushion valve	ø40 or smaller	Carbon steel
		ø50 or larger	Steel wire
			Zinc chromated

Note) For cylinders with auto switches, the magnet is installed in the piston.

\* The material for ø20, ø25 cylinders with auto switches is made of stainless steel.

No.	Description	Material	Note
15	Cushion seal A	Urethane	ø32 or larger is common.
16	Cushion seal B	Urethane	
17	Head cover	Aluminum alloy	Anodized
18	Cylinder tube	Aluminum alloy	Hard anodized
19	Rod seal	NBR	
20	Piston seal	NBR	
21	Tube gasket	NBR	
22	Valve seal	NBR	

### Replacement Parts: Seal Kit

Bore size (mm)	Kit no.	Contents
20	CG1N20Z-PS	Set of the nos. 19, 20, 21
25	CG1N25Z-PS	
32	CG1N32Z-PS	
40	CG1N40Z-PS	

Note) As sizes ø50 and larger cannot be disassembled, the seal cannot be replaced.

Note) Refer to the Specific Product Precautions on page 448 for Disassembly/Replacement.

\* The seal kit includes a grease pack (10 g).

Order with the following part number when only the grease pack is needed. **Grease pack part number: GR-S-010** (10 g)

**Basic: CG1BN**

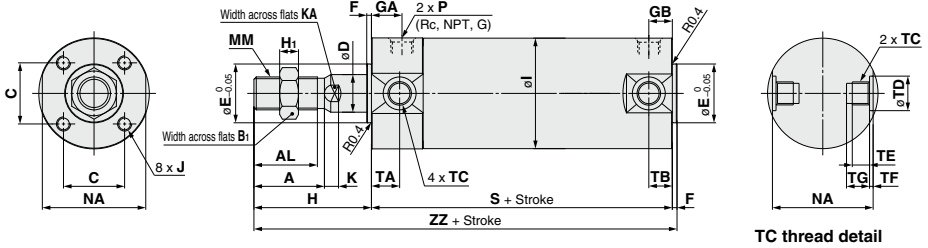

**With air cushion**

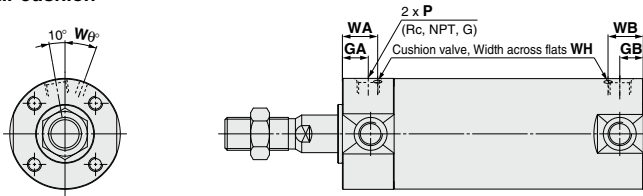

**Basic (Without trunnion mounting female thread): CG1ZN**

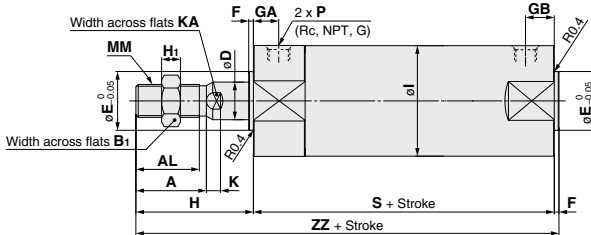

Bore size	Stroke range		Rc, NPT port			G port						(mm)										
	Standard	Long stroke	GA	GB	P	GA	GB	P	A	AL	B <sub>1</sub>	C	D	E	F	H	H <sub>1</sub>	I	J	K	KA	MM
20	Up to 200	201 to 1500	12	10 (12)	1/8	12	10 (12)	M5 x 0.8	18	15.5	13	14	8	12	2	35	5	26	M4 x 0.7 depth 7	5	6	M8 x 1.25
25	Up to 300	301 to 1500	12	10 (12)	1/8	12.5	10 (12.5)	M5 x 0.8	22	19.5	17	16.5	10	14	2	40	6	31	M5 x 0.8 depth 7.5	5.5	8	M10 x 1.25
32	Up to 300	301 to 1500	12	10 (12)	1/8	10.5	10 (10.5)	1/8	22	19.5	17	20	12	18	2	40	6	38	M5 x 0.8 depth 8	5.5	10	M10 x 1.25
40	Up to 300	301 to 1500	13	10 (13)	1/8	13	10 (10)	1/8	30	27	19	26	16	25	2	50	8	47	M6 x 1 depth 12	6	14	M14 x 1.5
50	Up to 300	301 to 1500	14	12 (14)	1/4	14	12 (14)	1/4	35	32	27	32	20	30	2	58	11	58	M8 x 1.25 depth 16	7	18	M18 x 1.5
63	Up to 300	301 to 1500	14	12 (14)	1/4	14	12 (14)	1/4	35	32	27	38	20	32	2	58	11	72	M10 x 1.5 depth 16	7	18	M18 x 1.5
80	Up to 300	301 to 1500	20	16 (20)	3/8	17.5	16 (17.5)	3/8	40	37	32	50	25	40	3	71	13	89	M10 x 1.5 depth 22	10	22	M22 x 1.5
100	Up to 300	301 to 1500	20	16 (20)	1/2	17.5	16 (17.5)	1/2	40	37	41	60	30	50	3	71	16	110	M12 x 1.75 depth 22	10	26	M26 x 1.5

Bore size	(mm)					With Air Cushion					(mm)					TC Thread					(mm)				
	NA	S	TA	TB	ZZ	Bore size	Rc, NPT port		WA	WB	Wθ	WH	Bore size	TC	TD	TE	TF	TG	Bore size	TC	TD	TE	TF	TG	
20	24	69 (77)	11	11	106 (114)	20	12	10 (12)	M5 x 0.8	16	15	(16)	25°	1.5	20	M5 x 0.8	8 <sup>0.08</sup>	4	0.5	5.5					
25	29	69 (77)	11	11	111 (119)	25	12.5	10 (12.5)	M5 x 0.8	16	14.5	(16)	25°	1.5	25	M6 x 0.75	10 <sup>0.08</sup>	5	1	6.5					
32	35.5	71 (79)	11	10 (11)	113 (121)	32	12	10 (12)	1/8	16	14	(16)	25°	1.5	32	M8 x 1.0	12 <sup>0.08</sup>	5.5	1	7.5					
40	44	78 (87)	12	10 (12)	130 (139)	40	13	10 (13)	1/8	17	15	(17)	20°	1.5	40	M10 x 1.25	14 <sup>0.08</sup>	6	1.25	8.5					
50	55	90 (102)	13	12 (13)	150 (162)	50	14	12 (14)	1/4	18	16	(18)	20°	3	50	M12 x 1.25	16 <sup>0.08</sup>	7.5	2	10					
63	69	90 (102)	13	12 (13)	150 (162)	63	14	12 (14)	1/4	18	17	(18)	20°	3	63	M14 x 1.5	18 <sup>0.08</sup>	11.5	3	14.5					
80	86	108 (122)	—	—	182 (196)	80	20	16 (20)	3/8	24	20	(24)	20°	4	80	—	—	—	—	—					
100	106	108 (122)	—	—	182 (196)	100	20	16 (20)	1/2	24	20	(24)	20°	4	100	—	—	—	—	—					

Note ( ) : Denotes the dimensions for long stroke.

\* Cylinder sizes ø80 and ø100 do not have trunnion mounting female thread on the width across flats NA.

# CG1 Series

## Basic: CG1BN

### With rod boot

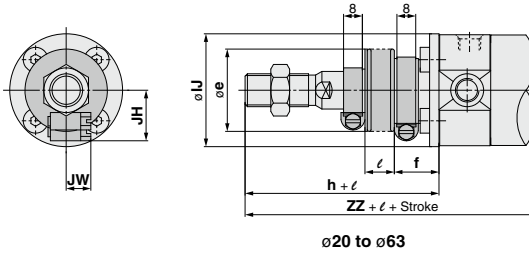

ø20 to ø63

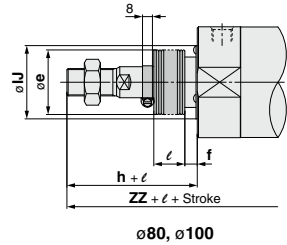

ø80, ø100

### With Rod Boot (mm)

Bore size	e	f	h	lJ	JH (Reference)	JW (Reference)	l	ZZ
20	30	18	55	27	15.5	10.5	1/4 stroke	126 (134)
25	30	19	62	32	16.5	10.5		133 (141)
32	35	19	62	38	18.5	10.5		135 (143)
40	35	19	70	48	21.5	10.5		150 (159)
50	40	19	78	59	24	10.5		170 (182)
63	40	20	78	72	24	10.5		170 (182)
80	52	10	80	59	—	—		191 (205)
100	62	7	80	71	—	—		191 (205)

\* The minimum stroke with rod boot is 20 mm.

### Female rod end

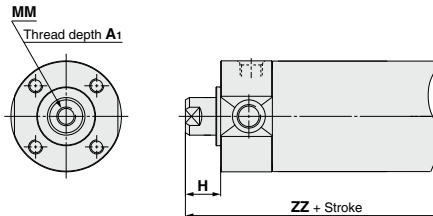

### Female Rod End (mm)

Bore size	A1	H	MM	ZZ
20	8	13	M4 x 0.7	84 (92)
25	8	14	M5 x 0.8	85 (93)
32	12	14	M6 x 1	87 (95)
40	13	15	M8 x 1.25	95 (104)
50	18	16	M10 x 1.5	108 (120)
63	18	16	M10 x 1.5	108 (120)
80	21	19	M14 x 1.5	130 (144)
100	25	22	M16 x 1.5	133 (147)

\* When female thread is used, use a washer etc. to prevent the contact part at the rod end from being deformed depending on the material of the workpiece.

**Axial Foot: CG1LN**

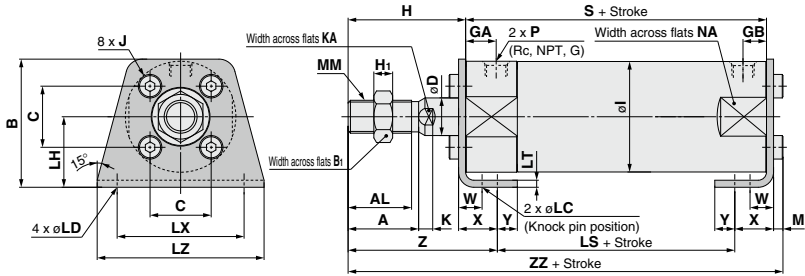

**With air cushion**

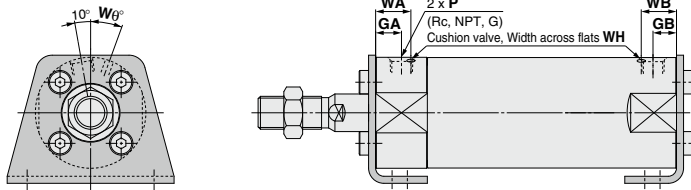

**With rod boot**

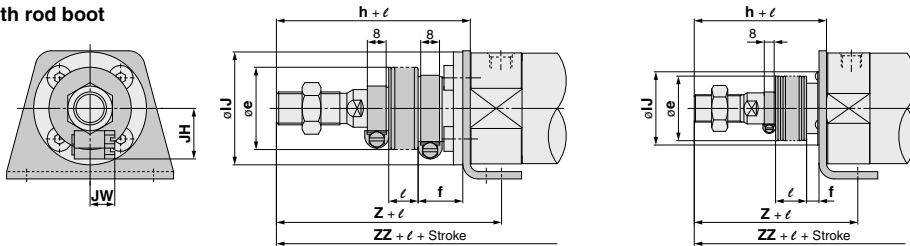

ø80, ø100

Bore size	Stroke range		Rc, NPT port			G port			G port																				
	Standard	Long stroke	GA	GB	P	GA	GB	P	A	AL	B	B1	C	D	H	H1	I	J	K	KAL	LC	LD	LH	LS	LT	LX	LZ	M	MM
20	Up to 200	201 to 1500	12	10 (12)	1/8	12	10 (12)	M5 x 0.8	18	15.5	34	13	14	8	35	5	26	M4 x 0.7	5	6	4	6	20	45 (53)	3	32	44	3	M8 x 1.25
25	Up to 300	301 to 1500	12	10 (12)	1/8	12.5	10 (12.5)	M5 x 0.8	22	19.5	38.5	17	16.5	10	40	6	31	M5 x 0.8	5.5	8	4	6	22	45 (53)	3	36	49	3.5	M10 x 1.25
32	Up to 300	301 to 1500	12	10 (12)	1/8	10.5	10 (10.5)	1/8	22	19.5	45	17	20	12	40	6	38	M5 x 0.8	5.5	10	4	7	25	45 (53)	3	44	58	3.5	M10 x 1.25
40	Up to 300	301 to 1500	13	10 (13)	1/8	13	10 (10)	1/8	30	27	54.5	19	26	16	50	8	47	M6 x 1	6	14	4	7	30	51 (60)	3	54	71	4	M14 x 1.5
50	Up to 300	301 to 1500	14	12 (14)	1/4	14	12 (14)	1/4	35	32	70.5	27	32	20	58	11	58	M8 x 1.25	7	18	5	10	40	55 (67)	4.5	66	86	5	M18 x 1.5
63	Up to 300	301 to 1500	14	12 (14)	1/4	14	12 (14)	1/4	35	32	82.5	27	38	20	58	11	72	M10 x 1.5	7	18	5	12	45	55 (67)	4.5	82	106	5	M18 x 1.5
80	Up to 300	301 to 1500	20	16 (20)	3/8	17.5	16 (17.5)	3/8	40	37	101	32	50	25	71	13	89	M10 x 1.5	10	22	6	11	55	60 (74)	4.5	100	125	5	M22 x 1.5
100	Up to 300	301 to 1500	20	16 (20)	1/2	17.5	16 (17.5)	1/2	40	37	121	41	60	30	71	16	110	M12 x 1.75	10	26	6	14	65	60 (74)	6	120	150	7	M26 x 1.5

ø80, ø100

(mm)

Bore size	(mm) With Air Cushion							(mm) With Rod Boot																
	NA	S	W	X	Y	Z	ZZ	Bore size	Rc, NPT port		WA	WB	Wθ	WH	Bore size	e	f	h	IJ	JH	JW	ℓ	Z	ZZ
									GA	GB	P									Reference	Reference	1/2 stroke		
20	24	69 (77)	10	15	7	47	110 (118)	20	12	10 (12)	M5 x 0.8	16	15 (16)	25°	1.5	20	30	18	55	27	15.5		10.5	67
25	29	69 (77)	10	15	7	52	115.5 (123.5)	25	12	10 (12.5)	M5 x 0.8	16	14.5 (16)	25°	1.5	25	30	19	62	32	16.5	10.5	74	137.5 (145.5)
32	35.5	71 (79)	10	16	8	53	117.5 (125.5)	32	12	10 (12)	1/8	16	14 (16)	25°	1.5	32	35	19	62	38	18.5	10.5	75	139.5 (147.5)
40	44	78 (87)	10	16.5	8.5	63.5	135 (144)	40	13	10 (13)	1/8	17	15 (17)	20°	1.5	40	35	19	70	48	21.5	10.5	83.5	155 (164)
50	55	90 (102)	17.5	22	11	75.5	157.5 (169.5)	50	14	12 (14)	1/4	18	16 (18)	20°	3	50	40	19	78	59	24	10.5	95.5	177.5 (189.5)
63	69	90 (102)	17.5	22	13	75.5	157.5 (169.5)	63	14	12 (14)	1/4	18	17 (18)	20°	3	63	40	20	78	72	24	10.5	95.5	177.5 (189.5)
80	86	108 (122)	20	28.5	14	95	188.5 (202.5)	80	20	16 (20)	3/8	24	20 (24)	20°	4	80	52	10	80	59	—	—	104	197.5 (211.5)
100	106	108 (122)	20	30	16	95	192 (206)	100	20	16 (20)	1/2	24	20 (24)	20°	4	100	62	7	80	71	—	—	104	201 (215)

\* For female rod end, since the wrench flap (K and KA portions) will be inside of the bracket when the piston rod is retracted at the stroke end, extend the piston rod to tighten the nut using a tool, and mount a workpiece on the rod end.  
\* Refer to the basic type for the female rod end.

Note ( ) : Denotes the dimensions for long stroke.

\* The minimum stroke with rod boot is 20 mm.

# CG1 Series

## Rod Flange: CG1FN

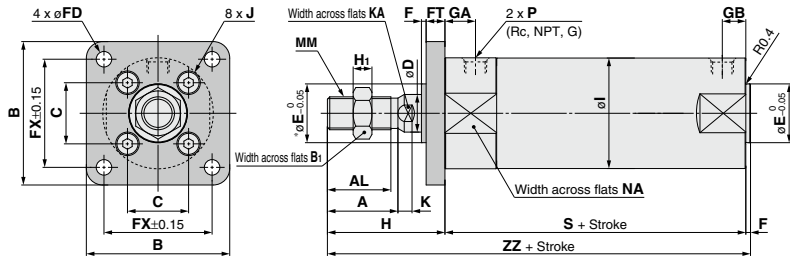

### With air cushion

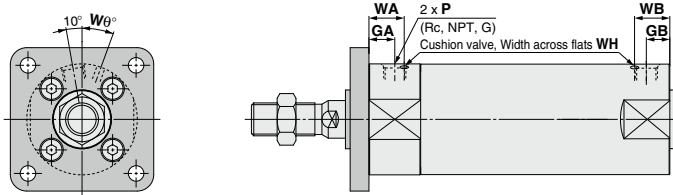

### With rod boot

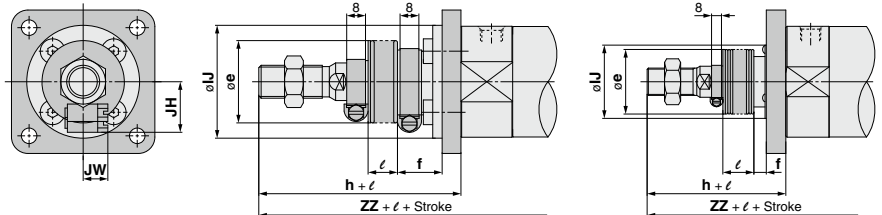

$\phi 80, \phi 100$

Bore size	Stroke range		Rc, NPT port			G port			A	AL	B	B <sub>i</sub>	C	D	E	F	FD	FT	FX	H	H <sub>i</sub>	I	J	K
	Standard	Long stroke	GA	GB	P	GA	GB	P																
20	Up to 200	201 to 1500	12	10 (12)	1/8	12	10 (12)	M5 x 0.8	18	15.5	40	13	14	8	12	2	5.5	6	28	35	5	26	M4 x 0.7	5
25	Up to 300	301 to 1500	12	10 (12)	1/8	12.5	10 (12.5)	M5 x 0.8	22	19.5	44	17	16.5	10	14	2	5.5	7	32	40	6	31	M5 x 0.8	5.5
32	Up to 300	301 to 1500	12	10 (12)	1/8	10.5	10 (10.5)	1/8	22	19.5	53	17	20	12	18	2	6.6	7	38	40	6	38	M5 x 0.8	5.5
40	Up to 300	301 to 1500	13	10 (13)	1/8	13	10 (10)	1/8	30	27	61	19	26	16	25	2	6.6	8	46	50	8	47	M6 x 1	6
50	Up to 300	301 to 1500	14	12 (14)	1/4	14	12 (14)	1/4	35	32	76	27	32	20	30	2	9	9	58	58	11	58	M8 x 1.25	7
63	Up to 300	301 to 1500	14	12 (14)	1/4	14	12 (14)	1/4	35	32	92	27	38	20	32	2	11	9	70	58	11	72	M10 x 1.5	7
80	Up to 300	301 to 1500	20	16 (20)	3/8	17.5	16 (17.5)	3/8	40	37	104	32	50	25	40	3	11	11	82	71	13	89	M10 x 1.5	10
100	Up to 300	301 to 1500	20	16 (20)	1/2	17.5	16 (17.5)	1/2	40	37	128	41	60	30	50	3	14	14	100	71	16	110	M12 x 1.75	10

Bore size	(mm) With Air Cushion					(mm) With Rod Boot																
	KA	MM	NA	S	ZZ	Bore size	Rc, NPT port			WA	WB	W $\theta$	WH	Bore size	e	f	h	IJ	JH (Reference)	JW (Reference)	$\ell$	ZZ
20	6	M8 x 1.25	24	69 (77)	106 (114)	20	12	10 (12)	M5 x 0.8	16	15 (16)	25°	1.5	20	30	18	55	27	15.5	10.5	—	126 (134)
25	8	M10 x 1.25	29	69 (77)	111 (119)	25	12.5	10 (12.5)	M5 x 0.8	16	14.5 (16)	25°	1.5	25	30	19	62	32	16.5	10.5	—	133 (141)
32	10	M10 x 1.25	35.5	71 (79)	113 (121)	32	12	10 (12)	1/8	16	14 (16)	25°	1.5	32	35	19	62	38	18.5	10.5	—	135 (143)
40	14	M14 x 1.5	44	78 (87)	130 (139)	40	13	10 (13)	1/8	17	15 (17)	20°	1.5	40	35	19	70	48	21.5	10.5	—	150 (159)
50	18	M18 x 1.5	55	90 (102)	150 (162)	50	14	12 (14)	1/4	18	16 (18)	20°	3	50	40	19	78	59	24	10.5	—	170 (182)
63	18	M18 x 1.5	69	90 (102)	150 (162)	63	14	12 (14)	1/4	18	17 (18)	20°	3	63	40	20	78	72	24	10.5	—	170 (182)
80	22	M22 x 1.5	86	108 (122)	182 (196)	80	20	16 (20)	3/8	24	20 (24)	20°	4	80	52	10	80	59	—	—	—	191 (205)
100	26	M26 x 1.5	106	108 (122)	182 (196)	100	20	16 (20)	1/2	24	20 (24)	20°	4	100	62	7	80	71	—	—	—	191 (205)

\* For female rod end, since the wrench flap (K and KA portions) will be inside of the bracket when the piston rod is retracted at the stroke end, extend the piston rod to tighten the nut using a tool, and mount a workpiece on the rod end.

\* Refer to the basic type for the female rod end.  
Note ( ) : Denotes the dimensions for long stroke.

\* The minimum stroke with rod boot is 20 mm.



**Head Flange: CG1GN**

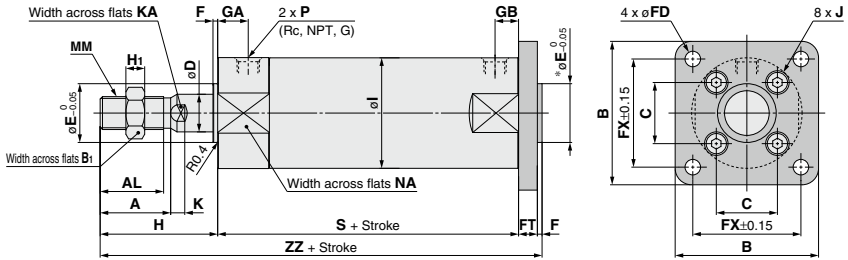

\* End boss is machined on the flange for  $\phi E$ .

**With air cushion**

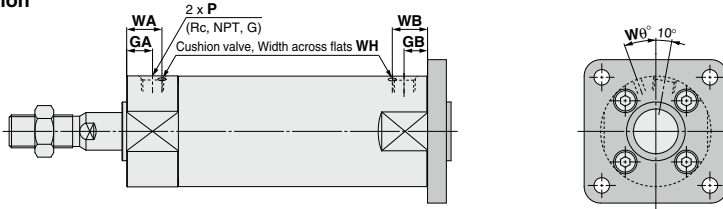

**With rod boot**

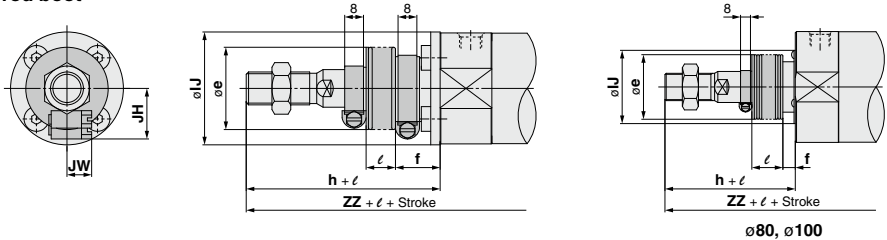

Bore size	Stroke range		Rc, NPT port			G port			A	AL	B	B <sub>1</sub>	C	D	E	F	FD	FT	FX	H	H <sub>1</sub>	I	J	K
	Standard	Long stroke	GA	GB	P	GA	GB	P																
20	Up to 200	201 to 1500	12	10 (12)	1/8	12	10 (12)	M5 x 0.8	18	15.5	40	13	14	8	12	2	5.5	6	28	35	5	26	M4 x 0.7	5
25	Up to 300	301 to 1500	12	10 (12)	1/8	12.5	10 (12.5)	M5 x 0.8	22	19.5	44	17	16.5	10	14	2	5.5	7	32	40	6	31	M5 x 0.8	5.5
32	Up to 300	301 to 1500	12	10 (12)	1/8	10.5	10 (10.5)	1/8	22	19.5	53	17	20	12	18	2	6.6	7	38	40	6	38	M5 x 0.8	5.5
40	Up to 300	301 to 1500	13	10 (13)	1/8	13	10 (10)	1/8	30	27	61	19	26	16	25	2	6.6	8	46	50	8	47	M6 x 1	6
50	Up to 300	301 to 1500	14	12 (14)	1/4	14	12 (14)	1/4	35	32	76	27	32	20	30	2	9	58	58	11	58	M8 x 1.25	7	
63	Up to 300	301 to 1500	14	12 (14)	1/4	14	12 (14)	1/4	35	32	92	27	38	20	32	2	11	9	70	58	11	72	M10 x 1.5	7
80	Up to 300	301 to 1500	20	16 (20)	3/8	17.5	16 (17.5)	3/8	40	37	104	32	50	25	40	3	11	11	82	71	13	89	M10 x 1.5	10
100	Up to 300	301 to 1500	20	16 (20)	1/2	17.5	16 (17.5)	1/2	40	37	128	41	60	30	50	3	14	14	100	71	16	110	M12 x 1.75	10

Bore size	(mm) With Air Cushion					(mm) With Rod Boot					JH (Reference)	JW (Reference)	$\ell$	ZZ											
	KA	MM	NA	S	ZZ	Bore size	GA	GB	P	WA					WB	W $\theta$	WH								
20	6	M8 x 1.25	24	69 (77)	112 (120)	20	12	10 (12)	M5 x 0.8	16	15	(16)	25°	1.5	20	30	19	62	32	16.5	10.5	140 (148)	—	—	—
25	8	M10 x 1.25	29	69 (77)	118 (126)	25	12.5	10 (12.5)	M5 x 0.8	16	14.5	(16)	25°	1.5	25	30	19	62	32	16.5	10.5	140 (148)	—	—	—
32	10	M10 x 1.25	35.5	71 (79)	120 (128)	32	12	10 (12)	1/8	16	14	(16)	25°	1.5	32	35	19	62	38	18.5	10.5	142 (150)	—	—	—
40	14	M14 x 1.5	44	78 (87)	138 (147)	40	13	10 (13)	1/8	17	15	(17)	20°	1.5	40	35	19	70	48	21.5	10.5	158 (167)	—	—	—
50	18	M18 x 1.5	55	90 (102)	159 (171)	50	14	12 (14)	1/4	18	16	(18)	20°	3	50	40	19	78	54	24	10.5	179 (191)	—	—	—
63	18	M18 x 1.5	69	90 (102)	159 (171)	63	14	12 (14)	1/4	18	17	(18)	20°	3	63	40	20	78	72	24	10.5	179 (191)	—	—	—
80	22	M22 x 1.5	86	108 (122)	193 (207)	80	20	16 (20)	3/8	24	20	(24)	20°	4	80	52	10	80	59	—	—	202 (216)	—	—	—
100	26	M26 x 1.5	106	108 (122)	196 (210)	100	20	16 (20)	1/2	24	20	(24)	20°	4	100	62	7	80	71	—	—	205 (219)	—	—	—

\* Refer to the basic type for the female rod end.  
Note ( ) : Denotes the dimensions for long stroke.

\* The minimum stroke with rod boot is 20 mm.

# CG1 Series

## Rod Trunnion: CG1UN

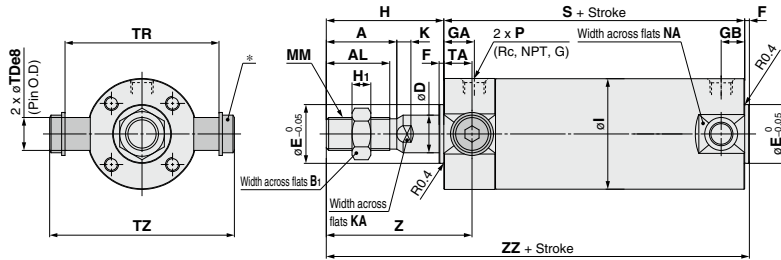

\* Constructed of a trunnion pin, flat washer and hexagon socket head cap bolt.

### With air cushion

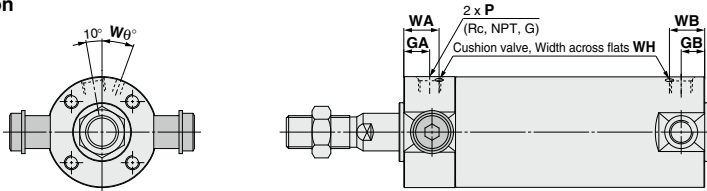

### With rod boot

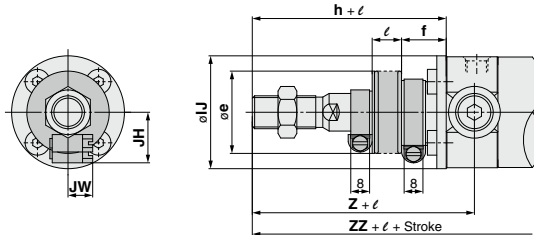

Bore size	Stroke range		Rc. NPT port			G port			A	AL	B <sub>1</sub>	D	E	F	H	H <sub>1</sub>	I	K	KA	MM	NA	S
	Standard	Long stroke	GA	GB	P	GA	GB	P														
20	Up to 200	201 to 1500	12	10 (12)	1/8	12	10 (12)	M5 x 0.8	18	15.5	13	8	12	2	35	5	26	5	6	M8 x 1.25	24	69 (77)
25	Up to 300	301 to 1500	12	10 (12)	1/8	12.5	10 (12.5)	M5 x 0.8	22	19.5	17	10	14	2	40	6	31	5.5	8	M10 x 1.25	29	69 (77)
32	Up to 300	301 to 1500	12	10 (12)	1/8	10.5	10 (10.5)	1/8	22	19.5	17	12	18	2	40	6	38	5.5	10	M10 x 1.25	35.5	71 (79)
40	Up to 300	301 to 1500	13	10 (13)	1/8	13	10 (10)	1/8	30	27	19	16	25	2	50	8	47	6	14	M14 x 1.5	44	78 (87)
50	Up to 300	301 to 1500	14	12 (14)	1/4	14	12 (14)	1/4	35	32	27	20	30	2	58	11	58	7	18	M18 x 1.5	55	90 (102)
63	Up to 300	301 to 1500	14	12 (14)	1/4	14	12 (14)	1/4	35	32	27	20	32	2	58	11	72	7	18	M18 x 1.5	69	90 (102)

(mm)

Bore size	(mm) With Air Cushion					(mm) With Rod Boot					(mm)												
	TA	TDe8	TR	TZ	ZZ	Bore size	Rc. NPT port		WA	WB	W <sub>0</sub>	WH	Bore size	e	f	h	J	JH	JW	ℓ	Z	ZZ	
							GA	GB	P								Reference	Reference					
20	11	8 <sup>+0.020</sup> <sub>-0.047</sub>	39	47.6	46	106 (114)	20	12	10 (12)	M5 x 0.8	16	15 (16)	25°	1.5	20	30	18	55	27	15.5	10.5	66	126 (134)
25	11	10 <sup>+0.020</sup> <sub>-0.047</sub>	43	53	51	111 (119)	25	12.5	10 (12.5)	M5 x 0.8	16	14.5 (16)	25°	1.5	25	30	19	62	32	16.5	10.5	73	133 (141)
32	11	12 <sup>+0.020</sup> <sub>-0.059</sub>	54.5	67.7	51	113 (121)	32	12	10 (12)	1/8	16	14 (16)	25°	1.5	32	35	19	62	38	18.5	10.5	73	135 (143)
40	12	14 <sup>+0.020</sup> <sub>-0.059</sub>	65.5	78.7	62	130 (139)	40	13	10 (13)	1/8	17	15 (17)	20°	1.5	40	35	19	70	48	21.5	10.5	82	150 (159)
50	13	16 <sup>+0.020</sup> <sub>-0.059</sub>	80	98.6	71	150 (162)	50	14	12 (14)	1/4	18	16 (18)	20°	3	50	40	19	78	59	24	10.5	91	170 (182)
63	13	18 <sup>+0.020</sup> <sub>-0.059</sub>	98	119.2	71	150 (162)	63	14	12 (14)	1/4	18	17 (18)	20°	3	63	40	20	78	72	24	10.5	91	170 (182)

\* Refer to the basic type for the female rod end.

Note ( ) : Denotes the dimensions for long stroke.

\* The minimum stroke with rod boot is 20 mm.

**Head Trunnion: CG1TN**

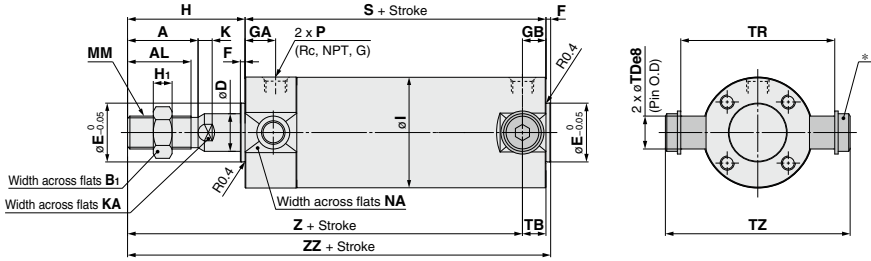

\* Constructed of a trunnion pin, flat washer and hexagon socket head cap bolt.

**With air cushion**

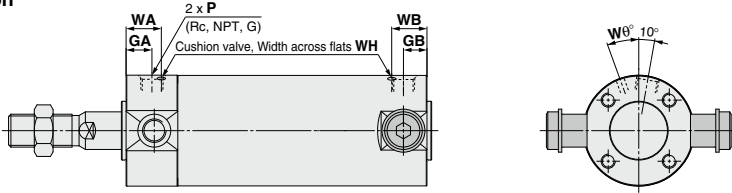

**With rod boot**

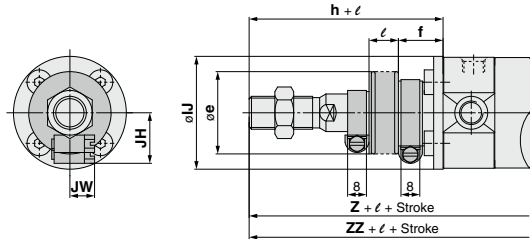

Bore size	Stroke range		Rc, NPT port			G port			A	AL	B <sub>1</sub>	D	E	F	H	H <sub>1</sub>	I	K	KA	MM	NA	S
	Standard	Long stroke	GA	GB	P	GA	GB	P														
20	Up to 200	201 to 1500	12	10 (12)	1/8	12	10 (12)	M5 x 0.8	18	15.5	13	8	12	2	35	5	26	5	6	M8 x 1.25	24	69 (77)
25	Up to 300	301 to 1500	12	10 (12)	1/8	12.5	10 (12.5)	M5 x 0.8	22	19.5	17	10	14	2	40	6	31	5.5	8	M10 x 1.25	29	69 (77)
32	Up to 300	301 to 1500	12	10 (12)	1/8	10.5	10 (10.5)	1/8	22	19.5	17	12	18	2	40	6	38	5.5	10	M10 x 1.25	35.5	71 (79)
40	Up to 300	301 to 1500	13	10 (13)	1/8	13	10 (10)	1/8	30	27	19	16	25	2	50	8	47	6	14	M14 x 1.5	44	78 (87)
50	Up to 300	301 to 1500	14	12 (14)	1/4	14	12 (14)	1/4	35	32	27	20	30	2	58	11	58	7	18	M18 x 1.5	55	90 (102)
63	Up to 300	301 to 1500	14	12 (14)	1/4	14	12 (14)	1/4	35	32	27	20	32	2	58	11	72	7	18	M18 x 1.5	69	90 (102)

Bore size	Stroke range		Rc, NPT port			WA	WB	W <sub>θ</sub>	WH	Bore size	e	f	h	IJ	JH	JW	l	Z	ZZ
	Standard	Long stroke	GA	GB	P														
20	11	8 <sub>0.020</sub> 10 <sub>0.047</sub>	39	47.6	93 (101)	16	15	(16)	25°	1.5	20	30	18	55	27	15.5	10.5	113 (121)	126 (134)
25	11	10 <sub>0.020</sub> 14 <sub>0.066</sub>	43	53	98 (106)	16	14.5	(16)	25°	1.5	25	30	19	62	32	16.5	10.5	120 (128)	133 (141)
32	10	12 <sub>0.020</sub> 15 <sub>0.055</sub>	54.5	67.7	101 (108)	16	14	(16)	25°	1.5	32	35	19	62	38	18.5	10.5	123 (130)	135 (143)
40	10 (12)	14 <sub>0.020</sub> 18 <sub>0.066</sub>	65.5	78.7	118 (125)	17	15	(17)	20°	1.5	40	35	19	70	48	21.5	10.5	138 (145)	150 (159)
50	12 (13)	16 <sub>0.020</sub> 20 <sub>0.066</sub>	80	98.6	136 (147)	18	16	(18)	20°	3	50	40	19	78	59	24	10.5	156 (167)	170 (182)
63	12 (13)	18 <sub>0.020</sub> 22 <sub>0.066</sub>	98	119.2	136 (147)	18	17	(18)	20°	3	63	40	20	78	72	24	10.5	156 (167)	170 (182)

\* Refer to the basic type for the female rod end.  
Note ( ) : Denotes the dimensions for long stroke.

\* The minimum stroke with rod boot is 20 mm.

# CG1 Series

## Clevis: CG1DN (ø20 to ø63)

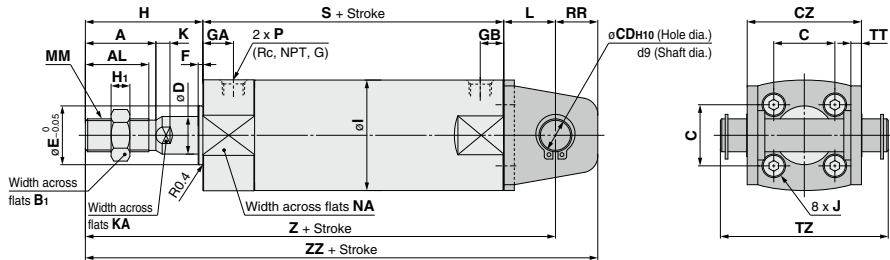

### With air cushion

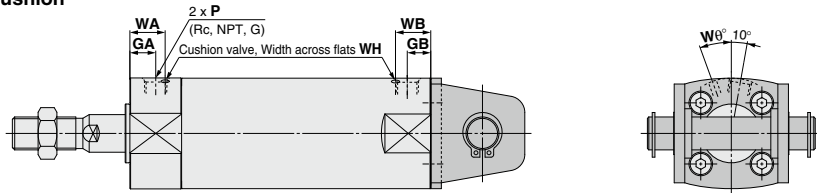

### With rod boot

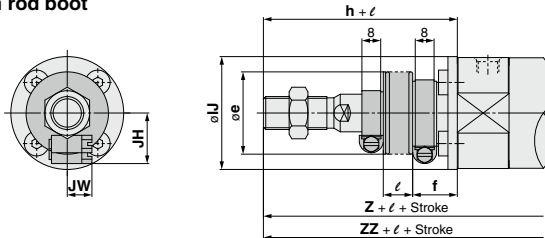

Stroke range		Rc, NPT port			G port																					
Bore size	Standard	Long stroke	GA	GB	P	GA	GB	P	A	AL	B <sub>1</sub>	C	CD	CZ	D	E	F	H	H <sub>1</sub>	I	J	K	KA	L	MM	NA
	20	Up to 200	201 to 1500	12	10 (12)	1/8	12	10 (12)	M5 x 0.8	18	15.5	13	14	8	29	8	12	2	35	5	26	M4 x 0.7	5	6	14	M8 x 1.25
25	Up to 300	301 to 1500	12	10 (12)	1/8	12.5	10 (12.5)	M5 x 0.8	22	19.5	17	16.5	10	33	10	14	2	40	6	31	M5 x 0.8	5.5	8	16	M10 x 1.25	29
32	Up to 300	301 to 1500	12	10 (12)	1/8	10.5	10 (10.5)	1/8	22	19.5	17	20	12	40	12	18	2	40	6	38	M5 x 0.8	5.5	10	20	M10 x 1.25	35.5
40	Up to 300	301 to 1500	13	10 (13)	1/8	13	10 (10)	1/8	30	27	19	26	14	49	16	25	2	50	8	47	M6 x 1	6	14	22	M14 x 1.5	44
50	Up to 300	301 to 1500	14	12 (14)	1/4	14	12 (14)	1/4	35	32	27	32	16	60	20	30	2	58	11	58	M8 x 1.25	7	18	25	M18 x 1.5	55
63	Up to 300	301 to 1500	14	12 (14)	1/4	14	12 (14)	1/4	35	32	27	38	18	74	20	32	2	58	11	72	M10 x 1.5	7	18	30	M18 x 1.5	69

  

(mm)														(mm)				(mm)							
Bore size	RR	S	TT	TZ	Z	ZZ	Applicable pin part no.	Bore size	Rc, NPT port			WA	WB	Wθ	WH	Bore size	e	f	h	J	JH	JW	ℓ	Z	ZZ
	20	11	69 (77)	3.2	43.4	118 (126)			129 (137)	CD-G02	20														
25	13	69 (77)	3.2	48	125 (133)	138 (146)	CD-G25	25	12.5	10 (12.5)	M5 x 0.8	16	14.5 (16)	25°	1.5	25	30	19	62	32	16.5	10.5	147 (155)	180 (188)	
32	15	71 (79)	4.5	59.4	131 (139)	146 (154)	CD-G03	32	12	10 (12)	1/8	16	14 (16)	25°	1.5	32	35	19	62	38	18.5	10.5	153 (161)	168 (176)	
40	18	78 (87)	4.5	71.4	150 (159)	168 (177)	CD-G04	40	13	10 (13)	1/8	17	15 (17)	20°	1.5	40	35	19	70	48	21.5	10.5	170 (179)	188 (197)	
50	20	90 (102)	6	86	173 (185)	193 (205)	CD-G05	50	14	12 (14)	1/4	18	16 (18)	20°	3	50	40	19	78	59	24	10.5	193 (205)	213 (225)	
63	22	90 (102)	8	105.4	178 (190)	200 (212)	CD-G06	63	14	12 (14)	1/4	18	17 (18)	20°	3	63	40	20	78	72	24	10.5	198 (210)	220 (232)	

\* Refer to the basic type for the female rod end.  
 Note ( ) : Denotes the dimensions for long stroke.

\* The minimum stroke with rod boot is 20 mm.

**Clevis: CG1DN (ø80, ø100)**

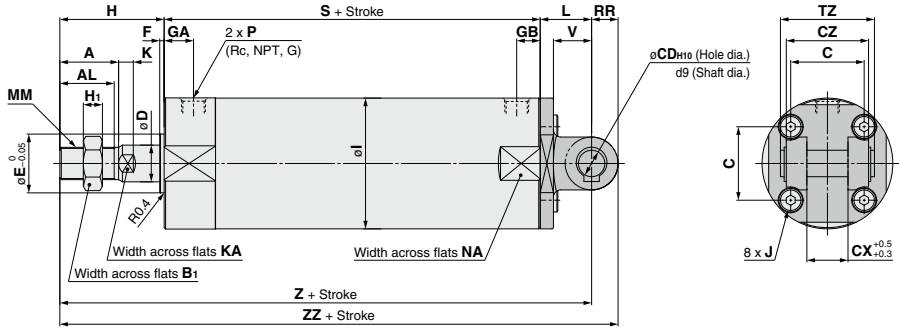

**With air cushion**

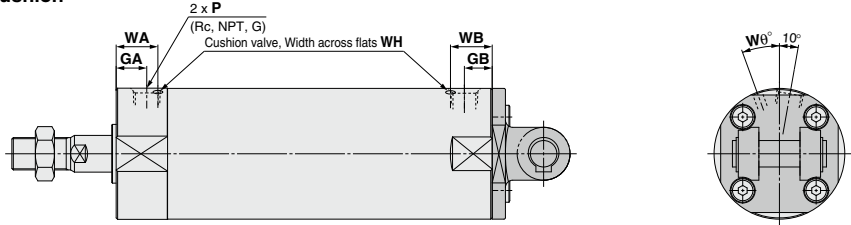

**With rod boot**

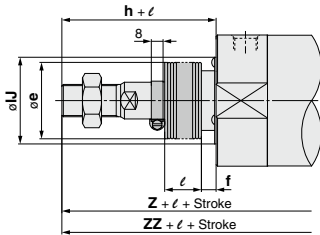

Bore size	Stroke range	Rc, NPT port			G port			A	AL	B1	C	CD	CX	CZ	D	E	F	H	H1	I	J	K	KA	L	MM	NA
		GA	GB	P	GA	GB	P																			
80	Up to 300 301 to 1500	20	16 (20)	3/8	17.5	16 (17.5)	3/8	40	37	32	50	18	28	56	25	40	3	71	13	89	M10 x 1.5	10	22	35	M22 x 1.5	86
100	Up to 300 301 to 1500	20	16 (20)	1/2	17.5	16 (17.5)	1/2	40	37	41	60	22	32	64	30	50	3	71	16	110	M12 x 1.75	10	26	43	M26 x 1.5	106

(mm)										(mm)				(mm)										
Bore size	RR	S	TZ	V	Z	ZZ	Applicable pin part no.	Bore size	Rc, NPT port			WA	WB	Wθ	WH	Bore size	e	f	h	l	J	l	Z	ZZ
									GA	GB	P													
80	18	108 (122)	64	26	214 (228)	232 (246)	IY-G08	80	20	16 (20)	3/8	24	20 (24)	20°	4	80	52	10	80	59	1/4	223 (237)	241 (255)	
100	22	108 (122)	72	32	222 (236)	244 (258)	IY-G10	100	20	16 (20)	1/2	24	20 (24)	20°	4	100	62	7	80	71	stroke	231 (245)	253 (267)	

\* Refer to the basic type for the female rod end.  
Note ( ) : Denotes the dimensions for long stroke.

\* The minimum stroke with rod boot is 20 mm.

# CG1 Series

With Pivot Bracket ((): Denotes the dimensions for long stroke.)

## Rod Trunnion (U) with Pivot Bracket

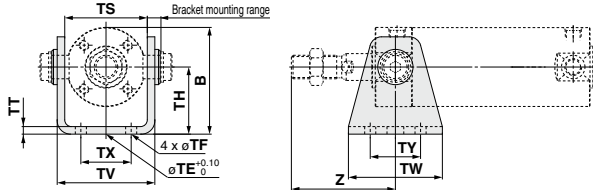

### Male Thread

Bore size	B	TE	TF	TH	TS	TT	TV	TW	TX	TY	Z
20	38	10	5.5	25	28	3.2	35.8	42	16	28	46
25	45.5	10	5.5	30	33	3.2	39.8	42	20	28	51
32	54	10	6.6	35	40	4.5	49.4	48	22	28	51
40	63.5	10	6.6	40	49	4.5	58.4	56	30	30	62
50	79	20	9	50	60	6	72.4	64	36	36	71
63	96	20	11	60	74	8	90.4	74	46	46	71

### Female Thread

Bore size	Z
20	24
25	25
32	25
40	27
50	29
63	29

## Head Trunnion (T) with Pivot Bracket

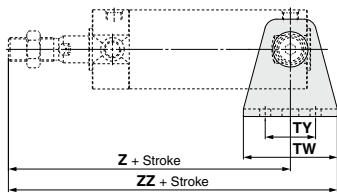

### Male Thread

Bore size	B	TE	TF	TH	TS	TT	TV	TW	TX	TY	Z	ZZ
20	38	10	5.5	25	28	3.2	35.8	42	16	28	93 (101)	114 (122)
25	45.5	10	5.5	30	33	3.2	39.8	42	20	28	98 (106)	119 (127)
32	54	10	6.6	35	40	4.5	49.4	48	22	28	101 (108)	125 (132)
40	63.5	10	6.6	40	49	4.5	58.4	56	30	30	118 (125)	146 (153)
50	79	20	9	50	60	6	72.4	64	36	36	136 (147)	168 (179)
63	96	20	11	60	74	8	90.4	74	46	46	136 (147)	173 (184)

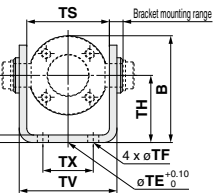

### Female Thread

Bore size	Z	ZZ
20	71 ( 79)	92 (100)
25	72 ( 80)	93 (101)
32	75 ( 82)	99 (106)
40	83 ( 90)	111 (118)
50	94 (105)	126 (137)
63	94 (105)	131 (142)

## Clevis (D) with Pivot Bracket ø20 to ø63

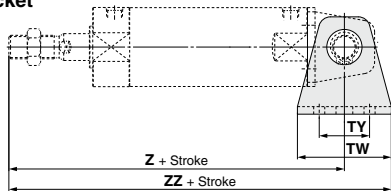

### Male Thread

Bore size	B	TE	TF	TH	TT	TV	TW	TX	TY	Z	ZZ
20	38	10	5.5	25	3.2	35.8	42	16	28	118 (126)	139 (147)
25	45.5	10	5.5	30	3.2	39.8	42	20	28	125 (133)	146 (154)
32	54	10	6.6	35	4.5	49.4	48	22	28	131 (139)	155 (163)
40	63.5	10	6.6	40	4.5	58.4	56	30	30	150 (159)	178 (187)
50	79	20	9	50	6	72.4	64	36	36	173 (185)	205 (217)
63	96	20	11	60	8	90.4	74	46	46	178 (190)	215 (227)

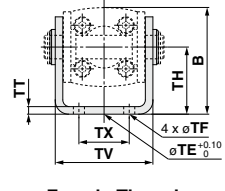

### Female Thread

Bore size	Z	ZZ
20	96 (104)	117 (125)
25	99 (107)	120 (128)
32	105 (113)	129 (137)
40	115 (124)	143 (152)
50	131 (143)	163 (175)
63	136 (148)	173 (185)

## Clevis (D) with Pivot Bracket ø80, ø100

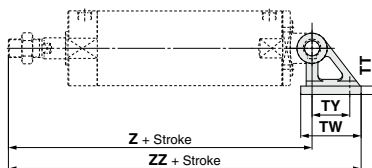

### Male Thread

Bore size	B	TF	TH	TT	TV	TW	TX	TY	Z	ZZ
80	99.5	11	55	11	110	72	85	45	214 (228)	272.5 (286.5)
100	120	13.5	65	12	130	93	100	60	222 (236)	298.5 (312.5)

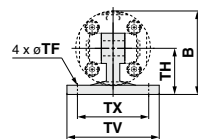

### Female Thread

Bore size	Z	ZZ
80	162 (176)	220.5 (234.5)
100	173 (187)	249.5 (263.5)

# CG1 Series

# Dimensions of Accessories

## Single Knuckle Joint

### I-G02, G03

Material: Carbon steel

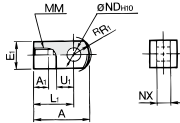

### I-G04, G05, G08, G10

Material: Cast iron

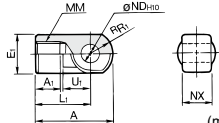

Part no.	Applicable bore size (mm)	A	A1	E1	L1	MM	R1	U1	NDH10	NX
I-G02	20	34	8.5	16	25	M8 x 1.25	10.3	11.5	8 <sup>+0.058</sup> <sub>-0.2</sub>	8 <sup>-0.2</sup> <sub>-0.2</sub>
I-G03	25, 32	41	10.5	20	30	M10 x 1.25	12.8	14	10 <sup>+0.058</sup> <sub>-0.2</sub>	10 <sup>-0.2</sup> <sub>-0.2</sub>
I-G04	40	42	14	22	30	M14 x 1.5	12	14	10 <sup>+0.058</sup> <sub>-0.2</sub>	18 <sup>-0.2</sup> <sub>-0.2</sub>
I-G05	50, 63	56	18	28	40	M18 x 1.5	16	20	14 <sup>+0.070</sup> <sub>-0.2</sub>	22 <sup>-0.2</sup> <sub>-0.2</sub>
I-G08	80	71	21	38	50	M22 x 1.5	21	27	18 <sup>+0.070</sup> <sub>-0.2</sub>	28 <sup>-0.2</sup> <sub>-0.2</sub>
I-G10	100	79	21	44	55	M26 x 1.5	24	31	22 <sup>+0.084</sup> <sub>-0.2</sub>	32 <sup>-0.2</sup> <sub>-0.2</sub>

## Knuckle Pin

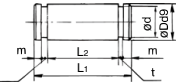

Material: Carbon steel

Part no.	Applicable bore size (mm)	Dd <sub>9</sub>	L1	d	L2	m	t	Included retaining ring
IY-G02	20	8 <sup>-0.040</sup> <sub>-0.076</sub>	21	7.6	16.2	1.5	0.9	Type C8 for axis
IY-G03	25, 32	10 <sup>-0.040</sup> <sub>-0.076</sub>	25.6	9.6	20.2	1.55	1.15	Type C10 for axis
IY-G04	40	10 <sup>-0.040</sup> <sub>-0.093</sub>	41.6	9.6	36.2	1.55	1.15	Type C10 for axis
IY-G05	50, 63	14 <sup>-0.050</sup> <sub>-0.093</sub>	50.6	13.4	44.2	2.05	1.15	Type C14 for axis
IY-G08	80	18 <sup>-0.050</sup> <sub>-0.093</sub>	64	17	56.2	2.55	1.35	Type C18 for axis
IY-G10	100	22 <sup>-0.065</sup> <sub>-0.117</sub>	72	21	64.2	2.55	1.35	Type C22 for axis

\* Retaining rings are included.

## Clevis Pin

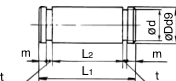

Material: Carbon steel

Part no.	Applicable bore size (mm)	Dd <sub>9</sub>	L1	d	L2	m	t	Included retaining ring
CD-G02	20	8 <sup>-0.040</sup> <sub>-0.076</sub>	43.4	7.6	38.6	1.5	0.9	Type C8 for axis
CD-G25	25	10 <sup>-0.040</sup> <sub>-0.076</sub>	48	9.6	42.6	1.55	1.15	Type C10 for axis
CD-G03	32	12 <sup>-0.050</sup> <sub>-0.093</sub>	59.4	11.5	54	1.55	1.15	Type C12 for axis
CD-G04	40	14 <sup>-0.050</sup> <sub>-0.093</sub>	71.4	13.4	65	2.05	1.15	Type C14 for axis
CD-G05	50	16 <sup>-0.050</sup> <sub>-0.093</sub>	86	15.2	79.6	2.05	1.15	Type C16 for axis
CD-G06	63	18 <sup>-0.050</sup> <sub>-0.093</sub>	105.4	17	97.8	2.45	1.35	Type C18 for axis

\* Retaining rings are included.

\* A clevis pin and a knuckle pin are common for the bore size  $\phi 80$  and  $\phi 100$ .

## Rod End Nut

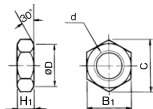

Material: Carbon steel

Part no.	Applicable bore size (mm)	d	H1	B1	C	D
NT-02	20	M8 x 1.25	5	13	(15)	12.5
NT-03	25, 32	M10 x 1.25	6	17	(19.6)	16.5
NT-G04	40	M14 x 1.5	8	19	(21.9)	18
NT-05	50, 63	M18 x 1.5	11	27	(31.2)	26
NT-08	80	M22 x 1.5	13	32	(37.0)	31
NT-10	100	M26 x 1.5	16	41	(47.3)	39

## Double Knuckle Joint

### Y-G02, G03

Material: Carbon steel

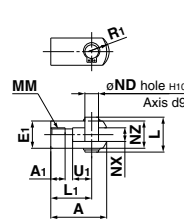

### Y-G04, G05, G08, G10

Material: Cast iron

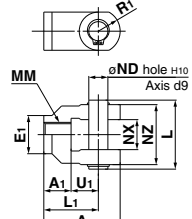

Part no.	Applicable bore size (mm)	A	A1	E1	L1	MM	R1	U1	ND	NX	NZ	L	Included pin part no.
Y-G02	20	34	8.5	16	25	M8 x 1.25	10.3	11.5	8	8 <sup>+0.4</sup> <sub>-0.2</sub>	16	21	IY-G02
Y-G03	25, 32	41	10.5	20	30	M10 x 1.25	12.8	14	10	10 <sup>+0.2</sup> <sub>-0.2</sub>	20	25.6	IY-G03
Y-G04	40	42	14	22	30	M14 x 1.5	12	14	10	18 <sup>+0.2</sup> <sub>-0.2</sub>	36	41.6	IY-G04
Y-G05	50, 63	56	18	28	40	M18 x 1.5	16	20	14	22 <sup>+0.2</sup> <sub>-0.2</sub>	44	50.6	IY-G05
Y-G08	80	71	21	38	50	M22 x 1.5	21	27	18	28 <sup>+0.2</sup> <sub>-0.2</sub>	56	64	IY-G08
Y-G10	100	79	24	44	55	M26 x 1.5	24	31	22	32 <sup>+0.2</sup> <sub>-0.2</sub>	64	72	IY-G10

\* A knuckle pin and retaining rings are included.

## Pivot Bracket

### $\phi 20$ to $\phi 63$

Material: Carbon steel

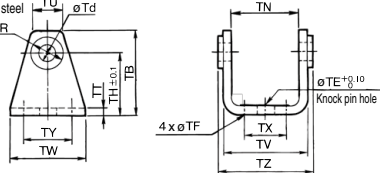

### $\phi 80, \phi 100$

Material: Cast iron

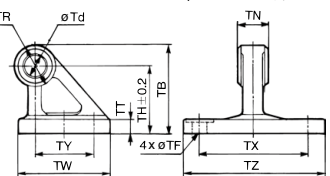

Part no.	Applicable bore size (mm)	TB	Td	TE	TF	TH	TN	TR	TR	TT
CG-020-24A	20	36	8	10	5.5	25	(29.3)	13	3.2	
CG-025-24A	25	43	10	10	5.5	30	(33.1)	15	3.2	
CG-032-24A	32	50	12	10	6.6	35	(40.4)	17	4.5	
CG-040-24A	40	58	14	10	6.6	40	(49.2)	21	4.5	
CG-050-24A	50	70	16	20	9	50	(60.4)	24	6	
CG-063-24A	63	82	18	20	11	60	(74.6)	26	8	
CG-080-24A	80	73	18	—	11	55	28 <sup>+0.1</sup> <sub>-0.1</sub>	36	11	
CG-100-24A	100	90	22	—	13.5	65	32 <sup>+0.1</sup> <sub>-0.1</sub>	50	12	

Part no.	Applicable bore size (mm)	TU	TV	TW	TX	TY	TZ	Applicable pin O.D.
CG-020-24A	20	(18.1)	(35.8)	42	16	28	38.3	8d <sub>9</sub> <sup>-0.040</sup> <sub>-0.076</sub>
CG-025-24A	25	(20.7)	(39.8)	42	20	28	42.1	10d <sub>9</sub> <sup>-0.040</sup> <sub>-0.076</sub>
CG-032-24A	32	(23.6)	(49.4)	48	22	28	53.8	12d <sub>9</sub> <sup>-0.050</sup> <sub>-0.093</sub>
CG-040-24A	40	(27.3)	(58.4)	56	30	30	64.6	14d <sub>9</sub> <sup>-0.050</sup> <sub>-0.093</sub>
CG-050-24A	50	(29.7)	(72.4)	64	36	36	79.2	16d <sub>9</sub> <sup>-0.050</sup> <sub>-0.093</sub>
CG-063-24A	63	(34.3)	(90.4)	74	46	46	97.2	18d <sub>9</sub> <sup>-0.050</sup> <sub>-0.093</sub>
CG-080-24A	80	—	—	72	85	45	110	18d <sub>9</sub> <sup>-0.050</sup> <sub>-0.093</sub>
CG-100-24A	100	—	—	93	100	60	130	22d <sub>9</sub> <sup>-0.065</sup> <sub>-0.117</sub>

# CG1 Series

## Mounting Brackets, Rod End Brackets, and Nut Material: Stainless Steel

### Part No.

Bore size (mm)	Axial foot*1	Single knuckle joint	Double knuckle joint*1	Rod end nut
20	—	I-G02SUS	Y-G02SUS	NT-02SUS
25	—			
32	CG-L032SUS	I-G03SUS	Y-G03SUS	NT-03SUS
40	CG-L040SUS	I-G04SUS	Y-G04SUS	NT-G04SUS
50	CG-L050SUS			
63	CG-L063SUS	I-G05SUS	Y-G05SUS	NT-05SUS
80	CG-L080SUS	I-G08SUS	Y-G08SUS	NT-08SUS
100	CG-L100SUS	I-G10SUS	Y-G10SUS	NT-10SUS

\*1 A knuckle pin and retaining rings are shipped together. Refer to the XC27 for details on stainless steel double clevis pins and double knuckle pins. The accessories need to be ordered separately from the cylinder.

## Dimensions

The single knuckle joint, double knuckle joint, mounting nut, and rod end nut are the same as the standard type.

### Axial foot

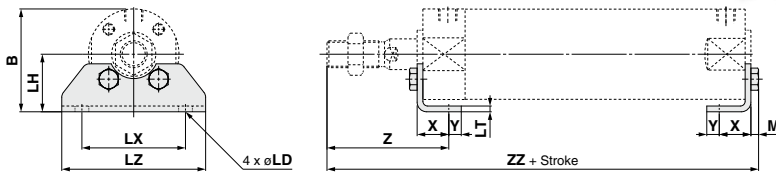

Bore size	B	LD	LH	LT	LX	LZ	M	X	Y	Z	ZZ
32	44	7.2	[25]	[3]	[44]	60	[3.5]	[16]	6	[53]	[117.5(125.5)]
40	53.5	7.2	[30]	[3]	[54]	75	[4]	[16.5]	6.5	[63.5]	[135(144)]
50	69	[10]	[40]	4	[66]	90	5.5	21.5	11.5	[75.5]	[157.5(169.5)]
63	81	[12]	[45]	4	[82]	110	7	21.5	11.5	[75.5]	159(171)
80	99.5	12	[55]	4	[100]	130	7	28	17	[95]	190(204)
100	125	[14]	[70]	[6]	[120]	160	8	[30]	15	[95]	193(207)

\*1 [ ]: Same as the standard type ( ): Denotes the dimensions for long strokes

\*2 Supplied with 4 mounting screws.





# Air Cylinder: Standard Type Double Acting, Double Rod

# CG1W Series

RoHS

ø20, ø25, ø32, ø40, ø50, ø63, ø80, ø100

## How to Order

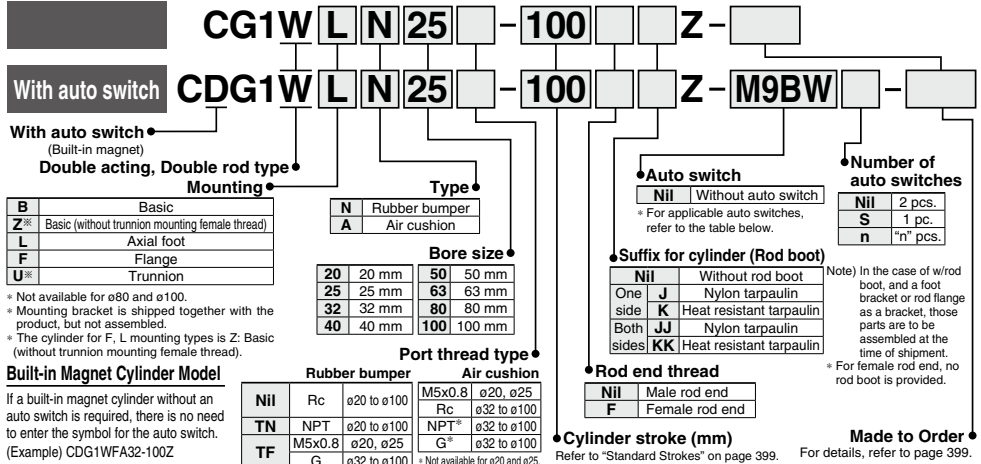

## Applicable Auto Switches

Refer to pages 1271 to 1365 for further information on auto switches.

Type	Special function	Electrical entry	Indicator light	Wiring (Output)	Load voltage		Auto switch model				Lead wire length (m)					Pre-wired connector	Applicable load
					DC	AC	Applicable bore size			0.5 (Nil)	1 (M)	3 (L)	5 (Z)	None (N)			
							ø20 to ø63	ø80, ø100	Perpendicular						In-line		
Solid state auto switch	—	Grommet	—	3-wire (NPN)	5 V, 12 V	—	M9NV	M9N	G59	●	●	●	○	○	○	IC circuit	
				3-wire (PNP)			M9PV	M9P	G5P	●	●	●	○	○			
				2-wire			M9BV	M9B	K59	●	●	●	○	○			
		Connector		—			H7C	●	●	●	○	○					
				3-wire (NPN)			M9NWV	M9NW	—	●	●	●	○	○			
				3-wire (PNP)			M9PWV	M9PW	—	●	●	●	○	○			
	Diagnostic indication (2-color indicator)	Grommet	Yes	2-wire	24 V	5 V, 12 V	—	M9BWV	M9BW	G5PW	●	●	●	○	○	IC circuit	
				3-wire (NPN)				M9NAV <sup>2,1</sup>	M9NA <sup>2,1</sup>	○	○	○	○	○			
				3-wire (PNP)				M9PAV <sup>2,1</sup>	M9PA <sup>2,1</sup>	○	○	●	○	○			
		Grommet		2-wire				M9BAV <sup>2,1</sup>	M9BA <sup>2,1</sup>	○	○	○	○	○			
				3-wire (NPN)				—	G5BA <sup>2,1</sup>	—	●	●	●	○	○		
				3-wire (PNP)				—	H7NF	—	●	●	●	○	○		
Water resistant (2-color indicator)	Grommet	Yes	2-wire	24 V	12 V	—	A96V	A96	—	●	●	●	○	○	IC circuit		
			3-wire (Equip. to NPN)				A93V <sup>2,2</sup>	A93	—	●	●	●	○	○			
			4-wire (Equip. to NPN)				A90V	A90	—	●	●	●	○	○			
	Connector		—				—	B54	●	●	●	○	○				
			—				—	B64	●	●	●	○	○				
			—				—	C73C	●	●	●	○	○				
Diagnostic output (2-color indicator)	Grommet	Yes	—	—	5 V	—	C80C	—	—	●	●	●	○	○	IC circuit		
			—				—	—	B59W	●	●	●	○	○			

\*1 Water resistant type auto switches can be mounted on the above models, but in such case SMC cannot guarantee water resistance. Please consult with SMC regarding water resistant types with the above model numbers.

\*2 1 m type lead wire is only applicable to D-A93.

\* Lead wire length symbols: 0.5 m..... Nil (Example) M9NW  
1 m..... M (Example) M9NWM  
3 m..... L (Example) M9NWL  
5 m..... Z (Example) M9NWZ  
None..... N (Example) H7CN

\* Solid state auto switches marked with "○" are produced upon receipt of order.

\* Since there are other applicable auto switches than listed above, refer to page 446 for details.

\* For details about auto switches with pre-wired connector, refer to pages 1340 and 1341.

\* The D-A93□□/M9□□□ auto switches are shipped together, (but not assembled). (However, only the auto switch mounting brackets are assembled before shipment.)



## Symbol

Rubber bumper

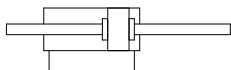

Air cushion

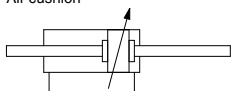

**Made to Order**  
[Click here for details](#)

Symbol	Specifications
-XA□	Change of rod end shape
-XB6	Heat resistant cylinder (-10 to 150°C)*1
-XB7	Cold resistant cylinder (-40 to 70°C)*2
-XC6	Made of stainless steel
-XC13	Auto switch rail mounting
-XC22	Fluororubber seal*1
-XC37	Larger throttle diameter of connection port
-XC85	Grease for food processing equipment

\*1 Cylinders with rubber bumper have no bumper.

\*2 Only compatible with cylinders with rubber bumper, but has no bumper.

## Rod Boot Material

Symbol	Rod boot material	Maximum operating temperature
<b>J</b>	Nylon tarpaulin	70°C
<b>K</b>	Heat resistant tarpaulin	110°C*

\* Maximum ambient temperature for the rod boot itself.

Refer to pages 440 to 446 for cylinders with auto switches.
<ul style="list-style-type: none"> <li>• Auto switch proper mounting position (detection at stroke end) and its mounting height</li> <li>• Minimum stroke for auto switch mounting</li> <li>• Auto switch mounting brackets/Part no.</li> <li>• Operating range</li> <li>• Cylinder mounting bracket, by stroke/ Auto switch mounting surfaces</li> </ul>

## ⚠ Precautions

Refer to page 448 before handling.

## Specifications

Bore size (mm)		20	25	32	40	50	63	80	100	
<b>Action</b>	Double acting, Double rod									
<b>Lubricant</b>	Not required (Non-lube)									
<b>Fluid</b>	Air									
<b>Proof pressure</b>	1.5 MPa									
<b>Maximum operating pressure</b>	1.0 MPa									
<b>Minimum operating pressure</b>	0.08 MPa									
<b>Ambient and fluid temperature</b>	Without auto switch: -10°C to 70°C With auto switch : -10°C to 60°C (No freezing)									
<b>Piston speed</b>	50 to 1000 mm/s							50 to 700 mm/s		
<b>Stroke length tolerance</b>	Up to 1000 st <sup>+1.4</sup> <sub>-0</sub> mm, Up to 1500 st <sup>+1.8</sup> <sub>-0</sub> mm									
<b>Cushion</b>	Rubber bumper, Air cushion									
<b>Mounting*</b>	Basic, Basic (without trunnion mounting female thread), Axial foot, Flange, Trunnion									
<b>Allowable kinetic energy (J)</b>	<b>Rubber bumper</b>	<b>Male rod end</b>	0.28	0.41	0.66	1.20	2.00	3.40	5.90	9.90
		<b>Female rod end</b>	0.11	0.18	0.29	0.52	0.91	1.54	2.71	4.54
	<b>Air cushion</b>	<b>Male rod end</b>	0.35	0.56	0.91	1.80	3.40	4.90	11.80	16.70
		<b>Female rod end</b>	0.11	0.18	0.29	0.52	0.91	1.54	2.71	4.54

\* Rod trunnion type is not available for ø80 and ø100.

Foot and flange types of cylinder sizes from ø20 to ø63 do not have trunnion mounting female thread. Operate the cylinder within the allowable kinetic energy.

## Accessories/Refer to page 395 for part numbers and dimensions.

Mounting		Basic	Axial foot	Rod flange	Rod trunnion
Standard	Rod end nut	●	●	●	●
	Single knuckle joint	●	●	●	●
Option	Double knuckle joint*2 (with pin)	●	●	●	●
	Pivot bracket*1	—	—	—	●*1
	Rod boot	●	●	●	●

\*1 Not available for ø80 and ø100.

\*2 A double knuckle joint pin and retaining rings are shipped together.

\*3 Stainless steel mounting brackets and accessories are also available. Refer to page 396 for details.

## Standard Strokes

Bore size (mm)	Standard stroke (mm) <sup>Note1)</sup>	Manufacturable stroke (mm)
<b>20</b>	25, 50, 75, 100, 125, 150, 200	1 to 1500
<b>25</b>	25, 50, 75, 100, 125, 150, 200, 250, 300	1 to 1500
<b>32</b>		
<b>40</b>		
<b>50, 63</b>		
<b>80</b>		
<b>100</b>		

Note 1) Intermediate strokes not listed above are produced upon receipt of order. Manufacture of intermediate strokes at 1 mm intervals is possible. (Spacers are not used.)

Note 2) Applicable strokes should be confirmed according to the usage. For details, refer to "Air Cylinders Model Selection" on pages 8 to 19. In addition, the products that exceed the standard stroke might not be able to fulfill the specifications due to the deflection etc.

# CG1W Series

## Weights

		(kg)							
Bore size (mm)		20	25	32	40	50	63	80	100
Basic weight	Basic	0.13	0.22	0.33	0.55	1.02	1.37	2.64	4.09
	Axial foot	0.24	0.35	0.49	0.77	1.50	2.09	3.60	5.84
	Flange	0.21	0.32	0.47	0.75	1.36	1.87	3.35	5.44
	Trunnion	0.14	0.24	0.36	0.60	1.16	1.51	—	—
Pivot bracket		0.08	0.09	0.17	0.25	0.44	0.80	—	—
Single knuckle joint		0.05	0.09	0.09	0.10	0.22	0.22	0.39	0.57
Double knuckle joint (with pin)		0.05	0.09	0.09	0.13	0.26	0.26	0.64	1.31
Additional weight per 50 mm of stroke		0.07	0.10	0.13	0.23	0.34	0.38	0.54	0.77
Additional weight with air cushion		0	0.01	0.04	0	0.01	0.04	0	0.04
Weight reduction for female rod end		-0.02	-0.04	-0.04	-0.10	-0.20	-0.20	-0.38	-0.54

Calculation (Example) **CG1WLN32-100Z**  
(Foot, ø32, 100 stroke)

• Basic weight ..... 0.49 (Foot, ø32)  
 • Additional weight ..... 0.13/50 stroke  
 • Air cylinder stroke ..... 100 stroke  
 0.49 x 0.13 x 100/50 = **0.75 kg**

## Mounting Brackets/Part No.

Mounting bracket	Order q'ty.	Bore size (mm)								Contents
		20	25	32	40	50	63	80	100	
Axial foot	2 (Note)	CG-L020	CG-L025	CG-L032	CG-L040	CG-L050	CG-L063	CG-L080	CG-L100	2 feet, 8 mounting bolts
Flange	1	CG-F020	CG-F025	CG-F032	CG-F040	CG-F050	CG-F063	CG-F080	CG-F100	1 flange, 4 mounting bolts
Trunnion pin	1	CG-T020	CG-T025	CG-T032	CG-T040	CG-T050	CG-T063	—	—	2 trunnion pins, 2 trunnion bolts, 2 flat washers
Pivot bracket	1	CG-020-24A	CG-025-24A	CG-032-24A	CG-040-24A	CG-050-24A	CG-063-24A	—	—	1 pivot bracket

Note) Order two feet per cylinder.

## Air-hydro

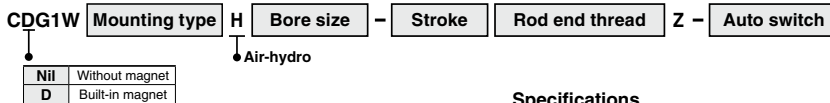

Low pressure hydraulic cylinder of 1.0 MPa or less  
 When using together with the CC series air-hydro unit, constant and low speed actuation and intermediate stopping similar to hydraulic units are possible with the use of valves and other pneumatic equipment.

### Dimensions: Same as the standard type

### Specifications

Bore size (mm)	20, 25, 32, 40, 50, 63
<b>Action</b>	Double acting, Single rod
<b>Fluid</b>	Turbine oil
<b>Proof pressure</b>	1.5 MPa
<b>Maximum operating pressure</b>	1.0 MPa
<b>Minimum operating pressure</b>	0.18 MPa
<b>Piston speed</b>	15 to 300 mm/s
<b>Cushion</b>	Rubber bumper (Standard equipment)
<b>Ambient and fluid temperatures</b>	5 to 60°C
<b>Mounting</b>	Basic, Axial foot, Flange, Trunnion

\* Auto switch can be mounted.

## Construction

### With rubber bumper

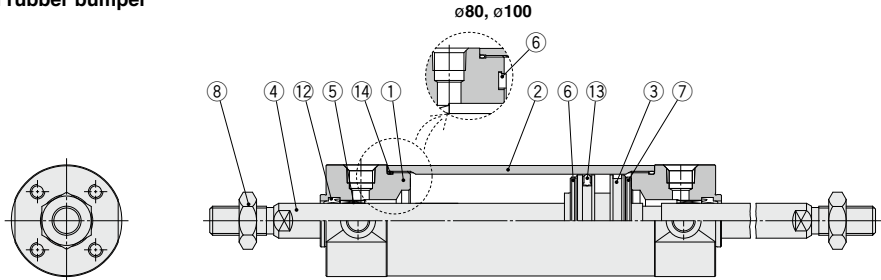

### With air cushion

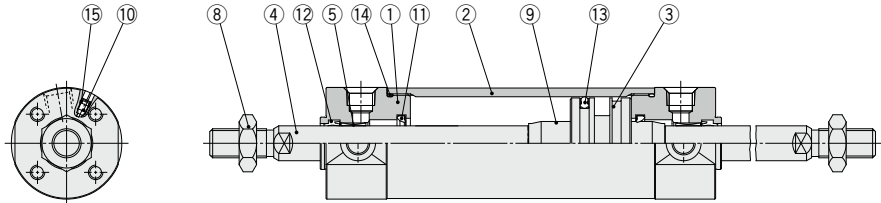

## Component Parts

No.	Description	Material	Note	
1	Rod cover	Aluminum alloy	Anodized	
2	Cylinder tube	Aluminum alloy	Hard anodized	
3	Piston	Aluminum alloy		
4	Piston rod	Stainless steel	For $\phi 20$ or $\phi 25$ with built-in magnet	
5	Bushing	Bearing alloy		
6	Bumper	Resin		
7	Bumper	Resin	$\phi 32$ or larger is common.	
8	Rod end nut	Carbon steel	Zinc chromated	
9	Cushion ring	Aluminum alloy		
10	Cushion valve	$\phi 40$ or smaller	Carbon steel	Electroless nickel plating
		$\phi 50$ or larger	Steel wire	Zinc chromated
11	Cushion seal	Urethane		
12	Rod seal	NBR		
13	Piston seal	NBR		
14	Tube gasket	NBR		
15	Valve seal	NBR		

Note) For cylinders with auto switches, the magnet is installed in the piston.

\* The material for  $\phi 20, \phi 25$  cylinders with auto switches is made of stainless steel.

## Replacement Parts: Seal Kit

Bore size (mm)	Kit no.	Contents
20	CG1WN20Z-PS	Set of the nos. 12, 13, 14
25	CG1WN25Z-PS	
32	CG1WN32Z-PS	
40	CG1WN40Z-PS	

Note) As sizes  $\phi 50$  and larger cannot be disassembled, the seal cannot be replaced.

Note) Refer to the Specific Product Precautions on page 448 for Disassembly/Replacement. Order with the kit number according to the bore size.

\* The seal kit includes a grease pack (10 g). Order with the following part number when only the grease pack is needed.

**Grease pack part number: GR-S-010 (10 g)**

# CG1W Series

## Basic with Rubber Bumper: CG1WBN

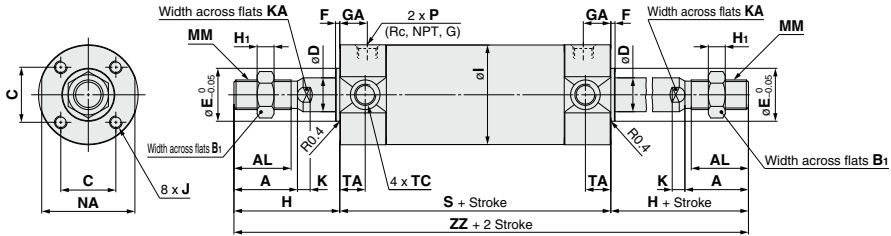

<With rod boot on one side>

Female rod end

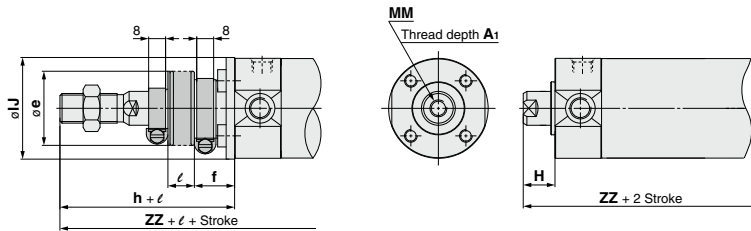

<With rod boot on both sides>

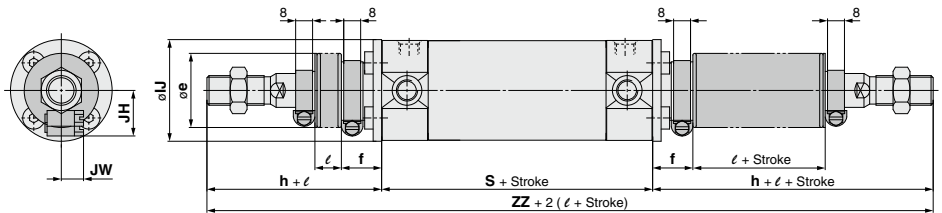

Bore size	Stroke range		Rc, NPT port		G port		A	AL	B1	C	D	E	F	H1	I	J		K	KA	MM	NA	S
	Standard	Long stroke	GA	P	GA	P										depth	depth					
20	Up to 200	201 to 1500	12	1/8	12	M5x0.8	18	15.5	13	14	8	12	2	5	26	M4 x 0.7	7	5	6	M8 x 1.25	24	77
25	Up to 300	301 to 1500	12	1/8	12.5	M5x0.8	22	19.5	17	16.5	10	14	2	6	31	M5 x 0.8	7.5	5.5	8	M10 x 1.25	29	77
32	Up to 300	301 to 1500	12	1/8	10.5	1/8	22	19.5	17	20	12	18	2	6	38	M5 x 0.8	8	5.5	10	M10 x 1.25	35.5	79
40	Up to 300	301 to 1500	13	1/8	13	1/8	30	27	19	26	16	25	2	8	47	M6 x 1	12	6	14	M14 x 1.5	44	87
50	Up to 300	301 to 1500	14	1/4	14	1/4	35	32	27	32	20	30	2	11	58	M8 x 1.25	16	7	18	M18 x 1.5	55	102
63	Up to 300	301 to 1500	14	1/4	14	1/4	35	32	27	38	20	32	2	11	72	M10 x 1.5	16	7	18	M18 x 1.5	69	102
80	Up to 300	301 to 1500	20	3/8	17.5	3/8	40	37	32	50	25	40	3	13	89	M10 x 1.5	22	10	22	M22 x 1.5	86	122
100	Up to 300	301 to 1500	20	1/2	17.5	1/2	40	37	41	60	30	50	3	16	110	M12 x 1.75	22	10	26	M26 x 1.5	106	122

Bore size	TA	TC**	Without rod boot		With rod boot on one side*										With rod boot* on both sides		Female Rod End			
			H	ZZ	e	f	h	IJ	JH (Reference)	JW (Reference)	l	ZZ	ZZ	Bore size	A1	H	MM	ZZ		
20	11	M5 x 0.8	35	147	30	18	55	27	15.5	10.5	1/4 stroke	167	187	20	8	13	M4 x 0.7	103		
25	11	M6 x 0.75	40	157	30	19	62	32	16.5	10.5		179	201	25	8	14	M5 x 0.8	105		
32	11	M8 x 1.0	40	159	35	19	62	38	18.5	10.5		181	203	32	12	14	M6 x 1	107		
40	12	M10 x 1.25	50	187	35	19	70	48	21.5	10.5		207	227	40	13	15	M8 x 1.25	117		
50	13	M12 x 1.25	58	218	40	19	78	59	24	10.5		238	258	50	18	16	M10 x 1.5	134		
63	13	M14 x 1.5	58	218	40	20	78	72	24	10.5		238	258	63	18	16	M10 x 1.5	134		
80	—	—	71	264	52	10	80	59	—	—		273	282	80	21	19	M14 x 1.5	160		
100	—	—	71	264	62	7	80	71	—	—		273	282	100	25	22	M16 x 1.5	166		

\* The minimum stroke with rod boot is 20 mm.

\*\* Cylinder sizes ø80 and ø100 do not have trunnion mounting female thread on the width across flats NA.

**Basic with Air Cushion: CG1WBA**

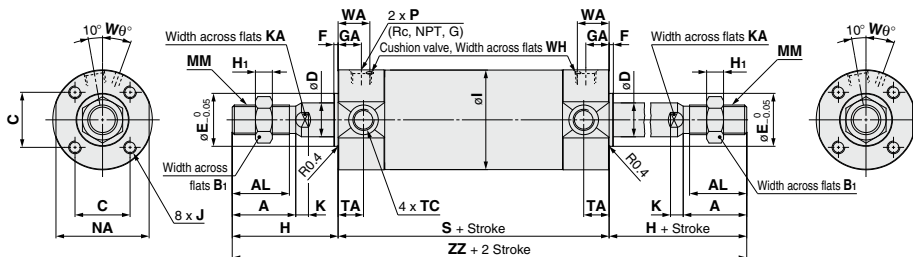

★ For the one with rod boot, refer to w/rubber bumper. (mm)

Bore size	Stroke range		Rc, NPT port		A	AL	B <sub>1</sub>	C	D	E	F	H	H <sub>1</sub>	I	J	K	KA
	Standard	Long stroke	GA	P													
<b>20</b>	Up to 200	201 to 1500	12	M5x0.8	18	15.5	13	14	8	12	2	35	5	26	M4 x 0.7 depth 7	5	6
<b>25</b>	Up to 300	301 to 1500	12.5	M5x0.8	22	19.5	17	16.5	10	14	2	40	6	31	M5 x 0.8 depth 7.5	5.5	8
<b>32</b>	Up to 300	301 to 1500	12	1/8	22	19.5	17	20	12	18	2	40	6	38	M5 x 0.8 depth 8	5.5	10
<b>40</b>	Up to 300	301 to 1500	13	1/8	30	27	19	26	16	25	2	50	8	47	M6 x 1 depth 12	6	14
<b>50</b>	Up to 300	301 to 1500	14	1/4	35	32	27	32	20	30	2	58	11	58	M8 x 1.25 depth 16	7	18
<b>63</b>	Up to 300	301 to 1500	14	1/4	35	32	27	38	20	32	2	58	11	72	M10 x 1.5 depth 16	7	18
<b>80</b>	Up to 300	301 to 1500	20	3/8	40	37	32	50	25	40	3	71	13	89	M10 x 1.5 depth 22	10	22
<b>100</b>	Up to 300	301 to 1500	20	1/2	40	37	41	60	30	50	3	71	16	110	M12 x 1.75 depth 22	10	26

Bore size	MM	NA	S	TA	TC**	ZZ	WA	Wθ	WH
<b>20</b>	M8 x 1.25	24	77	11	M5 x 0.8	147	16	25°	1.5
<b>25</b>	M10 x 1.25	29	77	11	M6 x 0.75	157	16	25°	1.5
<b>32</b>	M10 x 1.25	35.5	79	11	M8 x 1.0	159	16	25°	1.5
<b>40</b>	M14 x 1.5	44	87	12	M10 x 1.25	187	17	20°	1.5
<b>50</b>	M18 x 1.5	55	102	13	M12 x 1.25	218	18	20°	3
<b>63</b>	M18 x 1.5	69	102	13	M14 x 1.5	218	18	20°	3
<b>80</b>	M22 x 1.5	86	122	—	—	264	24	20°	4
<b>100</b>	M26 x 1.5	106	122	—	—	264	24	20°	4

\* For mounting brackets, refer to page 395.

\*\* Cylinder sizes ø80 and ø100 do not have trunnion mounting female thread on the width across flats NA.

\* Refer to w/rubber bumper for the female rod end.

# CG1W Series

## With Mounting Bracket

### Axial foot: CG1WL□

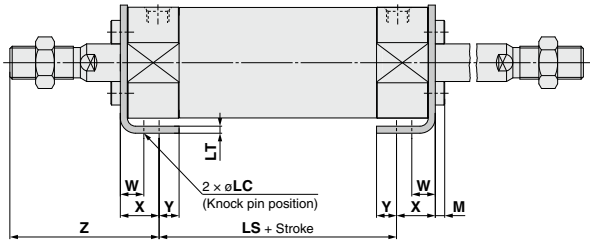
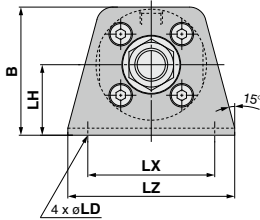

(mm)

Bore size	Stroke range	B	LC	LD	LH	LS	LT	LX	LZ	M	W	X	Y	Z
20	Up to 1500	34	4	6	20	53	3	32	44	3	10	15	7	47
25	Up to 1500	38.5	4	6	22	53	3	36	49	3.5	10	15	7	52
32	Up to 1500	45	4	7	25	53	3	44	58	3.5	10	16	8	53
40	Up to 1500	54.5	4	7	30	60	3	54	71	4	10	16.5	8.5	63.5
50	Up to 1500	70.5	5	10	40	67	4.5	66	86	5	17.5	22	11	75.5
63	Up to 1500	82.5	5	12	45	67	4.5	82	106	5	17.5	22	13	75.5
80	Up to 1500	101	6	11	55	74	4.5	100	125	5	20	28.5	14	95
100	Up to 1500	121	6	14	65	74	6	120	150	7	20	30	16	95

\* Other dimensions are the same as basic type.

### Flange: CG1WF□

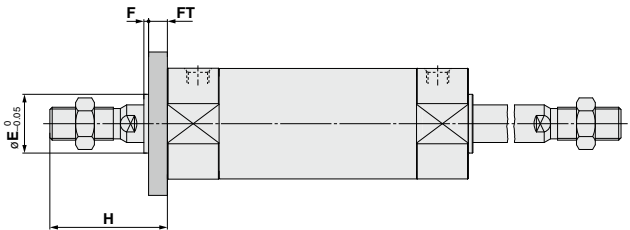
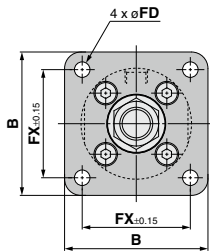

(mm)

Bore size	Stroke range	B	E	F	FX	FD	FT	H
20	Up to 1500	40	12	2	28	5.5	6	35
25	Up to 1500	44	14	2	32	5.5	7	40
32	Up to 1500	53	18	2	38	6.6	7	40
40	Up to 1500	61	25	2	46	6.6	8	50
50	Up to 1500	76	30	2	58	9	9	58
63	Up to 1500	92	32	2	70	11	9	58
80	Up to 1500	104	40	3	82	11	11	71
100	Up to 1500	128	50	3	100	14	14	71

\* End boss is machined on the flange for øE.

\* Other dimensions are the same as basic type.



**With Mounting Bracket**

Trunnion: CG1WU□

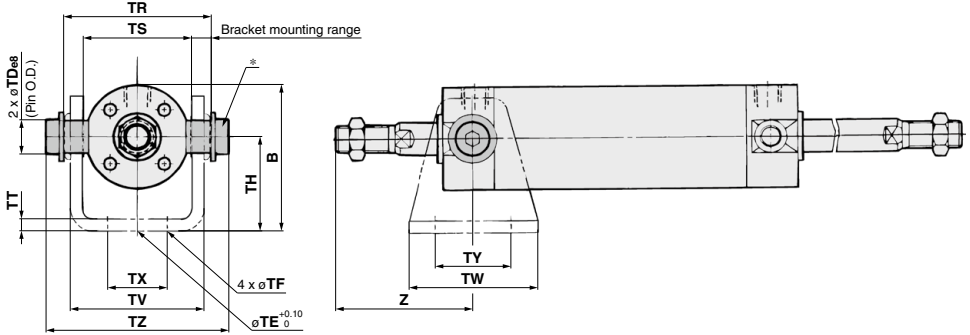

(mm)

Bore size	Stroke range	B	TDe8	TE	TF	TH	TR	TS	TT	TV	TW	TX	TY	TZ	Z	
															Without rod boot	With rod boot
20	Up to 1500	38	8 <sup>+0.025</sup> <sub>-0.047</sub>	10	5.5	25	39	28	3.2	(35.8)	42	16	28	47.6	46	66 + ℓ
25	Up to 1500	45.5	10 <sup>+0.025</sup> <sub>-0.047</sub>	10	5.5	30	43	33	3.2	(39.8)	42	20	28	53	51	73 + ℓ
32	Up to 1500	54	12 <sup>+0.032</sup> <sub>-0.059</sub>	10	6.6	35	54.5	40	4.5	(49.4)	48	22	28	67.7	51	73 + ℓ
40	Up to 1500	63.5	14 <sup>+0.032</sup> <sub>-0.059</sub>	10	6.6	40	65.5	49	4.5	(58.4)	56	30	30	78.7	62	82 + ℓ
50	Up to 1500	79	16 <sup>+0.032</sup> <sub>-0.059</sub>	20	9	50	80	60	6	(72.4)	64	36	36	98.6	71	91 + ℓ
63	Up to 1500	96	18 <sup>+0.032</sup> <sub>-0.059</sub>	20	11	60	98	74	8	(90.4)	74	46	46	119.2	71	91 + ℓ

\* Constructed of a pin, flat washer and hexagon socket head cap bolt.

\* Other dimensions are the same as basic type.

# Air Cylinder: Standard Type Single Acting, Spring Return/Extend

## CG1 Series

ø20, ø25, ø32, ø40

RoHS



### How to Order

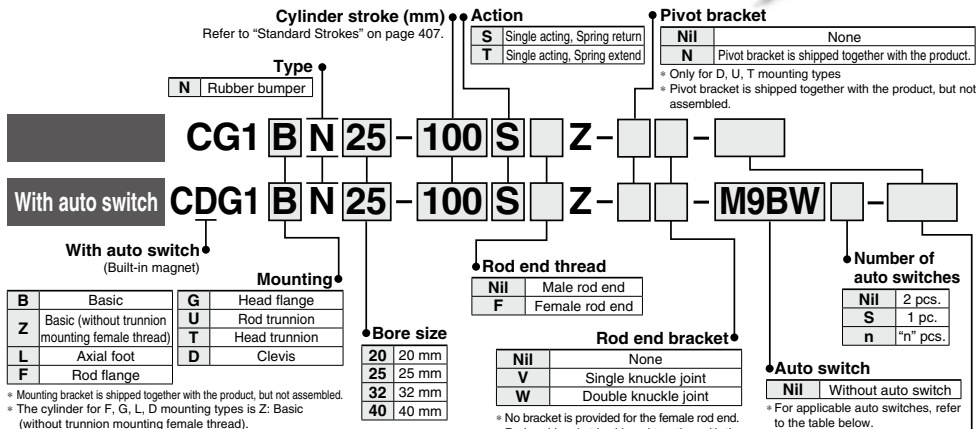

### Built-in Magnet Cylinder Model

If a built-in magnet cylinder without an auto switch is required, there is no need to enter the symbol for the auto switch. (Example) CDG1FN32-100TZ

### Made to Order

For details, refer to page 407.

\* Refer to "Ordering Example of Cylinder Assembly" on page 408.

### Applicable Auto Switches/Refer to pages 1271 to 1365 for further information on auto switches.

Type	Special function	Electrical entry	Indicator light	Wiring (Output)	Load voltage		Auto switch model		Lead wire length (m)					Pre-wired connector	Applicable load					
					DC	AC	Applicable bore size ø20 to ø40		0.5 (Nil)	1 (M)	3 (L)	5 (Z)	None (N)							
							Perpendicular	In-line												
Solid state auto switch	Diagnostic indication (2-color indicator)	Grommet	Yes	3-wire (NPN)	5 V, 12 V	—	M9NV	M9N	●	●	●	○	—	○	Relay, PLC					
				3-wire (PNP)			M9PV	M9P	●	●	●	○	—	○						
		Connector	—	2-wire	12 V	—	M9BV	M9B	●	●	●	○	—	○						
				—	—	H7C	—	—	—	—	—	—	—							
		Water resistant (2-color indicator)	Grommet	Yes	3-wire (NPN)	5 V, 12 V	—	M9NVW	M9NW	●	●	●	○	—		○	Relay, PLC			
					3-wire (PNP)			M9PVW	M9PW	●	●	●	○	—		○				
	Connector		—	2-wire	12 V	—	M9BVW	M9BW	●	●	●	○	—	○						
				—	—	—	M9NAV <sup>*1</sup>	M9NA <sup>*1</sup>	○	○	○	○	—	○						
	Diagnostic output (2-color indicator)	Grommet	Yes	3-wire (PNP)	5 V, 12 V	—	M9PAV <sup>*3</sup>	M9PA <sup>*3</sup>	○	○	●	○	—	○	Relay, PLC					
				2-wire			12 V	—	M9BAV <sup>*3</sup>	M9BA <sup>*3</sup>	○	○	○	○		—	○			
Connector		—	4-wire (NPN)	5 V, 12 V	—	—	H7NF	—	○	—	○	—	○							
			—	—	—	—	—	A96V	A96	●	—	●	—	—						
Reed auto switch	Diagnostic indication (2-color indicator)	Grommet	Yes	3-wire (Equiv. to NPN)	—	5 V	—	A93V <sup>*2</sup>	A93	●	●	●	●	—	Relay, PLC					
										100 V	—	—	—	—		—	—	—	—	
		Connector	Yes	2-wire	24 V	12 V	—	—	—	—	—	100 V or less	A90V	A90	●	●	●	●	—	—
												100 V, 200 V	—	B54	●	●	●	●	—	—
		Grommet	No	—	—	—	—	—	—	—	—	200 V or less	—	B64	●	●	●	●	—	—
												—	—	—	—	—	—	—	—	—
Connector	Yes	—	—	—	—	—	—	—	—	24 V or less	—	C73C	●	●	●	●	—	—		
										—	—	—	—	—	—	—	—	—		
Grommet	No	—	—	—	—	—	—	—	—	—	—	C80C	●	●	●	●	—	—		
										—	—	—	—	—	—	—	—	—		
Connector	Yes	—	—	—	—	—	—	—	—	—	—	B59W	●	●	●	●	—	—		
										—	—	—	—	—	—	—	—	—		

\*1 Water resistant type auto switches can be mounted on the above models, but in such case SMC cannot guarantee water resistance.

Please consult with SMC regarding water resistant types with the above model numbers.

\*2 1 m type lead wire is only applicable to D-A93.

\* Lead wire length symbols: 0.5 m..... Nil (Example) M9NW  
 1 m..... M (Example) M9NW  
 3 m..... L (Example) M9NWL  
 5 m..... Z (Example) M9NWZ  
 None..... Nil (Example) H7CN

\* Solid state auto switches marked with "○" are produced upon receipt of order.

\* Since there are other applicable auto switches than listed above, refer to page 446 for details.

\* For details about auto switches with pre-wired connector, refer to pages 1340 and 1341.

\* The D-A9□□/M9□□ auto switches are shipped together, (but not assembled). (However, only the auto switch mounting brackets are assembled before shipment.)

## Specifications

Bore size (mm)	20	25	32	40	20	25	32	40
<b>Action</b>	Single acting, Spring return				Single acting, Spring extend			
<b>Lubricant</b>	Not required (Non-lube)							
<b>Fluid</b>	Air							
<b>Proof pressure</b>	1.5 MPa							
<b>Maximum operating pressure</b>	1.0 MPa							
<b>Minimum operating pressure</b>	0.18 MPa				0.23 MPa			
<b>Ambient and fluid temperature</b>	Without auto switch: -10°C to 70°C (No freezing) With auto switch : -10°C to 60°C							
<b>Piston speed</b>	50 to 1000 mm/s							
<b>Stroke length tolerance</b>	Up to 200 st <sup>+14</sup> <sub>0</sub> mm							
<b>Cushion</b>	Rubber bumper							
<b>Mounting</b>	Basic, Basic (without trunnion mounting female thread), Axial foot, Rod flange, Head flange, Rod trunnion, Head trunnion, Clevis							



### Symbol

Spring return, Rubber bumper

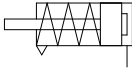

Spring extend, Rubber bumper

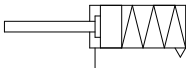

**Made to Order**

[Click here for details](#)

Symbol	Specifications
-XC6	Made of stainless steel
-XC20	Head cover axial port <sup>*2</sup>
-XC27	Double clevis and double knuckle joint pins made of stainless steel
-XC29	Double knuckle joint with spring pin <sup>*1</sup>
-XC85	Grease for food processing equipment

<sup>\*1</sup> Applicable only to single acting, spring return type.  
For single acting, spring extend type, please contact SMC.

<sup>\*2</sup> Only compatible with cylinders with rubber bumper.

## Accessories

Refer to page 395 for part numbers and dimensions.

Mounting		Basic	Axial foot	Rod flange	Head flange	Rod trunnion	Head trunnion	Clevis
Standard	Rod end nut	●	●	●	●	●	●	●
	Clevis pin	—	—	—	—	—	—	●
Option	Single knuckle joint	●	●	●	●	●	●	●
	Double knuckle joint <sup>*1</sup> (with pin)	●	●	●	●	●	●	●
	Pivot bracket	—	—	—	—	●	●	●

<sup>\*1</sup> A double knuckle joint pin and retaining rings are shipped together.

<sup>\*2</sup> Stainless steel mounting brackets and accessories are also available.  
Refer to page 396 for details.

## Standard Strokes

Bore size	Standard stroke <sup>Note1)</sup> (mm)
20	25, 50, 75, 100, 125
25, 32, 40	25, 50, 75, 100, 125, 150, 200

Note 1) Manufacture of intermediate strokes at 1 mm intervals is possible. (Spacers are not used.)

Note 2) Applicable strokes should be confirmed according to the usage. For details, refer to "Air Cylinders Model Selection" on pages 8 to 19. In addition, the products that exceed the standard stroke might not be able to fulfill the specifications due to the deflection etc.

## Theoretical Output

Refer to page 1575.

## Spring Reaction Force

Refer to page 1572.

Refer to pages 440 to 446 for cylinders with auto switches.

- Auto switch proper mounting position (detection at stroke end) and its mounting height
- Minimum stroke for auto switch mounting
- Auto switch mounting brackets/Part no.
- Operating range
- Cylinder mounting bracket, by stroke/ Auto switch mounting surfaces



## Precautions

Refer to page 448 before handling.

## Mounting Brackets/Part No.

Mounting bracket	Order q'ty.	Bore size (mm)				Contents
		20	25	32	40	
Axial foot	2 <sup>Note)</sup>	CG-L020	CG-L025	CG-L032	CG-L040	2 feet, 8 mounting bolts
Flange	1	CG-F020	CG-F025	CG-F032	CG-F040	1 flange, 4 mounting bolts
Trunnion pin	1	CG-T020	CG-T025	CG-T032	CG-T040	2 trunnion pins, 2 trunnion bolts, 2 flat washers
Clevis	1	CG-D020	CG-D025	CG-D032	CG-D040	1 clevis, 4 mounting bolts, 1 clevis pin, 2 retaining rings
Pivot bracket	1	CG-020-24A	CG-025-24A	CG-032-24A	CG-040-24A	1 pivot bracket

Note) Order two feet per cylinder.

# CG1 Series

## Ordering Example of Cylinder Assembly

Cylinder model: **CDG1DN20-100Z-NW-M9BW**

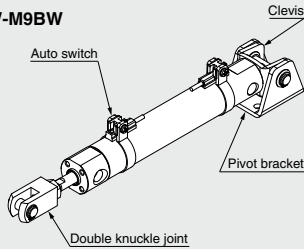

Mounting	D: Clevis
Pivot bracket	N: Yes
Rod end bracket	W: Double knuckle joint
Auto switch	D-M9BW: 2 pcs.

\*Pivot bracket, double knuckle joint and auto switch are shipped together with the product, but not assembled.

## Weights

### Spring return

(kg)

Bore size (mm)		20	25	32	40
Basic weight	25 st	0.17	0.27	0.40	0.63
	50 st	0.19	0.30	0.45	0.71
	75 st	0.26	0.40	0.58	0.91
	100 st	0.28	0.43	0.62	0.99
	125 st	0.35	0.53	0.76	1.20
	150 st	—	0.56	0.81	1.28
	200 st	—	0.69	0.98	1.56
Mounting bracket weight	Axial foot	0.11	0.13	0.16	0.22
	Flange	0.08	0.10	0.14	0.20
	Trunnion	0.01	0.02	0.03	0.05
	Clevis	0.05	0.08	0.15	0.23
Accessories	Pivot bracket	0.08	0.09	0.17	0.25
	Single knuckle joint	0.05	0.09	0.09	0.10
	Double knuckle joint (with pin)	0.05	0.09	0.09	0.13
Weight reduction for female rod end		-0.01	-0.02	-0.02	-0.05

Calculation (Example) **CG1LN20-100SZ** • Basic weight..... 0.28 kg (ø20)  
 (Foot, ø20, 100 stroke) • Mounting bracket weight..... 0.11 kg (Foot)  
 0.28 + 0.11 = **0.39 kg**

### Spring extend

(kg)

Bore size (mm)		20	25	32	40
Basic weight	25 st	0.16	0.25	0.38	0.59
	50 st	0.18	0.28	0.43	0.67
	75 st	0.24	0.37	0.54	0.83
	100 st	0.26	0.40	0.58	0.91
	125 st	0.32	0.48	0.69	1.08
	150 st	—	0.50	0.72	1.12
	200 st	—	0.63	0.89	1.40
Mounting bracket weight	Axial foot	0.11	0.13	0.16	0.22
	Flange	0.08	0.10	0.14	0.20
	Trunnion	0.01	0.02	0.03	0.05
	Clevis	0.05	0.08	0.15	0.23
Accessories	Pivot bracket	0.08	0.09	0.17	0.25
	Single knuckle joint	0.05	0.09	0.09	0.10
	Double knuckle joint (with pin)	0.05	0.09	0.09	0.13
Weight reduction for female rod end		-0.01	-0.02	-0.02	-0.05

Calculation (Example) **CG1LN20-100TZ** • Basic weight..... 0.26 kg (ø20)  
 (Foot, ø20, 100 stroke) • Mounting bracket weight..... 0.11 kg (Foot)  
 0.26 + 0.11 = **0.37 kg**

## Construction

### Single acting, Spring return

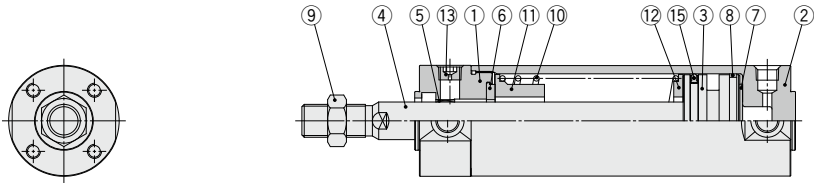

### Single acting, Spring extend

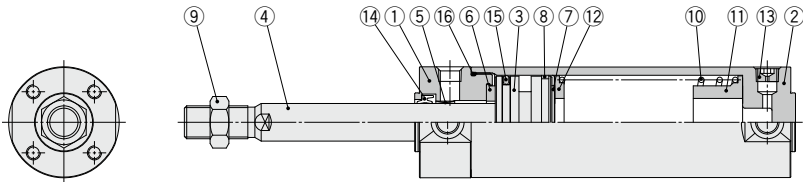

## Component Parts

No.	Description	Material	Note
1	Rod cover	Aluminum alloy	Anodized
2	Tube cover	Aluminum alloy	Hard anodized
3	Piston	Aluminum alloy	
4	Piston rod	Stainless steel	For ø20 or ø25 with built-in magnet
		Carbon steel*	Hard chrome plating*
5	Bushing	Bearing alloy	
6	Bumper	Resin	ø32 or larger is common.
7	Bumper	Resin	
8	Wear ring	Resin	
9	Rod end nut	Carbon steel	Zinc chromated
10	Return spring	Steel wire	Zinc chromated
11	Spring guide	Aluminum alloy	
12	Spring seat	Aluminum alloy	
13	Plug with breathing hole	Alloy steel	Black zinc chromated
14	Rod seal	NBR	
15	Piston seal	NBR	
16	Tube gasket	NBR	

Note) For cylinders with auto switches, the magnet is installed in the piston.  
\* The material for ø20, ø25 cylinders with auto switches is made of stainless steel.

## Replacement Part: Seal

### • For single acting, spring return

No.	Description	Material	Part no.			
			20	25	32	40
15	Piston seal	NBR	CG1N20-S-PS	CG1N25-S-PS	CG1N32-S-PS	CG1N40-S-PS

### • For single acting, spring extend

Replacement parts/Seal kits are the same as standard type, double acting, single rod (with rubber bumper). Refer to page 384.

Note) Refer to the Specific Product Precautions on page 448 for Disassembly/Replacement.

\* The seal kit includes a grease pack (10 g).

Order with the following part number when only the grease pack is needed.

**Grease pack part number: GR-S-010 (10 g)**

# CG1 Series

## Basic

### Spring return: CG1BN

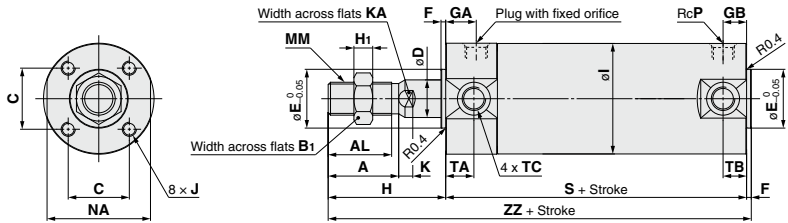

### Spring extend: CG1BN

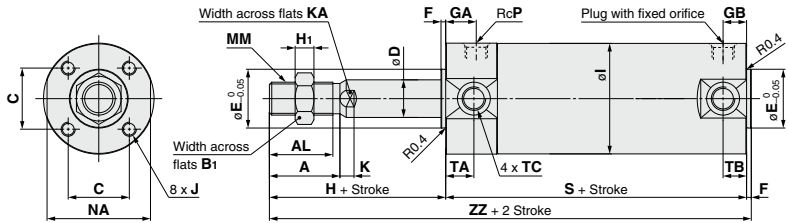

### Female rod end

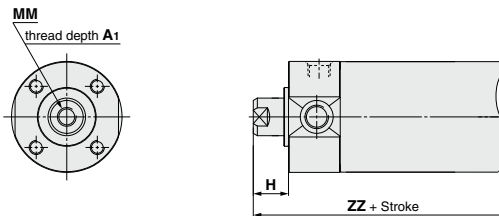

Bore size	Stroke range	A	AL	B <sub>1</sub>	C	D	E	F	GA	GB	H	H <sub>1</sub>	I	J	K	KA	MM	NA	P
20	Up to 125	18	15.5	13	14	8	12	2	12	10	35	5	26	M4 x 0.7 depth 7	5	6	M8 x 1.25	24	1/8
25	Up to 200	22	19.5	17	16.5	10	14	2	12	10	40	6	31	M5 x 0.8 depth 7.5	5.5	8	M10 x 1.25	29	1/8
32	Up to 200	22	19.5	17	20	12	18	2	12	10	40	6	38	M5 x 0.8 depth 8	5.5	10	M10 x 1.25	35.5	1/8
40	Up to 200	30	27	19	26	16	25	2	13	10	50	8	47	M6 x 1 depth 12	6	14	M14 x 1.5	44	1/8

  

Bore size	TA	TB	TC	1 to 50 st		51 to 100 st		101 to 125 st		126 to 200 st		Female Rod End							
				S	ZZ	S	ZZ	S	ZZ	S	ZZ	Bore size	A <sub>1</sub>	H	MM	1 to 50 st	51 to 100 st	101 to 125 st	126 to 200 st
20	11	11	M5 x 0.8	94	131	119	156	144	181	—	—	20	8	13	M4 x 0.7	109	134	159	—
25	11	11	M6 x 0.75	94	136	119	161	144	186	169	211	25	8	14	M5 x 0.8	110	135	160	185
32	11	10	M8 x 1.0	96	138	121	163	146	188	171	213	32	12	14	M6 x 1	112	137	162	187
40	12	10	M10 x 1.25	103	155	128	180	153	205	178	230	40	13	15	M8 x 1.25	120	145	170	195

# Air Cylinder: Standard Type Single Acting, Spring Return/Extend **CG1 Series**

**With Mounting Bracket** (Note) The drawings below show the single acting/spring return type.)  
The rod is in retracted state for spring extend type.

## Axial foot: CG1LN

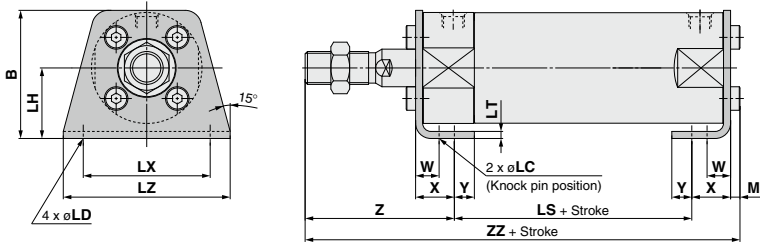

Bore size	Stroke range	B	M	LC	LD	LH	LT	LX	LZ	W	X	Y	Z	1 to 50 st		51 to 100 st		101 to 125 st		126 to 200 st	
														LS	ZZ	LS	ZZ	LS	ZZ	LS	ZZ
20	Up to 125	34	3	4	6	20	3	32	44	10	15	7	47	70	135	95	160	120	185	—	—
25	Up to 200	38.5	3.5	4	6	22	3	36	49	10	15	7	52	70	140.5	95	165.5	120	190.5	145	215.5
32	Up to 200	45	3.5	4	7	25	3	44	58	10	16	8	53	70	142.5	95	167.5	120	192.5	145	217.5
40	Up to 200	54.5	4	4	7	30	3	54	71	10	16.5	8.5	63.5	76	160	101	185	126	210	151	235

## Rod flange: CG1FN

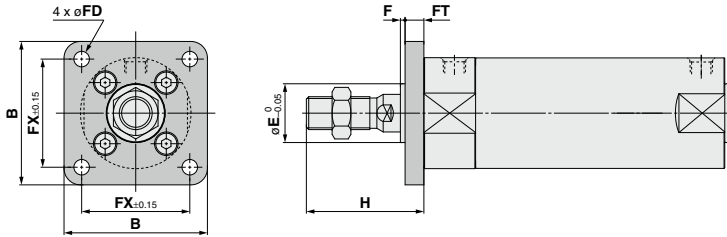

## Head flange: CG1GN

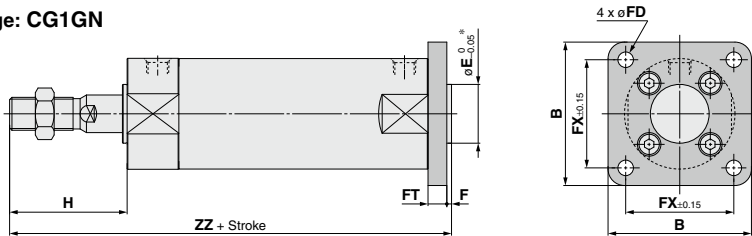

Bore size	Stroke range	B	E	F	FX	FD	FT	H
20	Up to 125	40	12	2	28	5.5	6	35
25	Up to 200	44	14	2	32	5.5	7	40
32	Up to 200	53	18	2	38	6.6	7	40
40	Up to 200	61	25	2	46	6.6	8	50

\* End boss is machined on the flange for øE.

## Rod Flange (mm)

Bore size	ZZ			
	1 to 50 st	51 to 100 st	101 to 125 st	126 to 200 st
20	131	156	181	—
25	136	161	186	211
32	138	163	188	213
40	155	180	205	230

## Head Flange (mm)

Bore size	ZZ			
	1 to 50 st	51 to 100 st	101 to 125 st	126 to 200 st
20	130	162	187	—
25	143	168	193	218
32	145	170	195	220
40	163	188	213	238

# CG1 Series

## With Mounting Bracket

### Rod trunnion: CG1UN

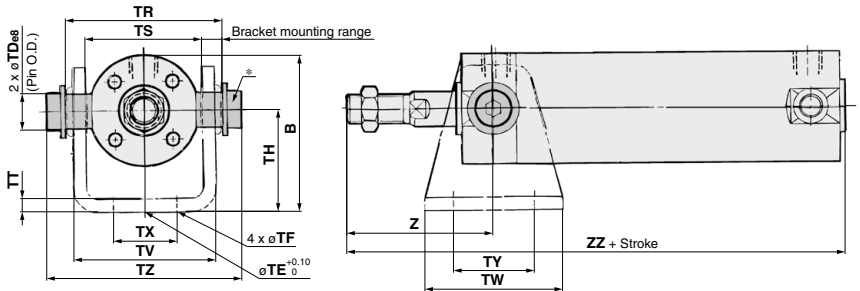

### Head trunnion: CG1TN

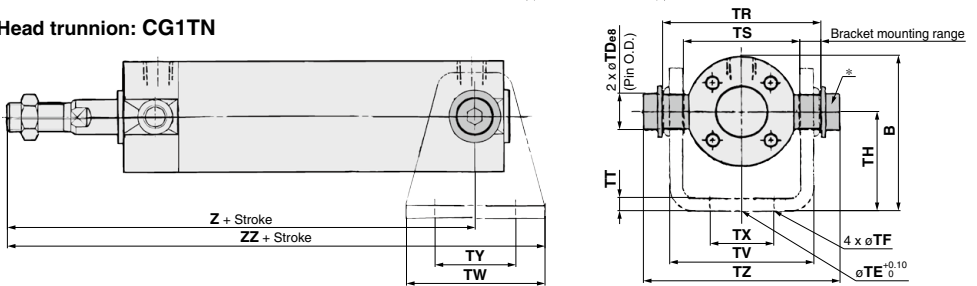

Bore size	Stroke range	B	TDeø	TE	TF	TH	TR	TS	TT	TV	TW	TX	TY	TZ
20	Up to 125	38	8 <sup>+0.025</sup> <sub>-0.047</sub>	10	5.5	25	39	28	3.2	(35.8)	42	16	28	47.6
25	Up to 200	45.5	10 <sup>+0.025</sup> <sub>-0.047</sub>	10	5.5	30	43	33	3.2	(39.8)	42	20	28	53
32	Up to 200	54	12 <sup>+0.032</sup> <sub>-0.059</sub>	10	6.6	35	54.5	40	4.5	(49.4)	48	22	28	67.7
40	Up to 200	63.5	14 <sup>+0.032</sup> <sub>-0.059</sub>	10	6.6	40	65.5	49	4.5	(58.4)	56	30	30	78.7

#### Rod Trunnion

Bore size	Z	ZZ		
		1 to 50 st	51 to 100 st	101 to 125 st
20	46	131	156	181
25	51	136	161	186
32	51	138	163	188
40	62	155	180	205

#### Head Trunnion

Bore size	1 to 50 st		51 to 100 st		101 to 125 st		126 to 200 st	
	Z	ZZ	Z	ZZ	Z	ZZ	Z	ZZ
20	118	139	143	164	168	189	—	—
25	123	144	148	169	173	194	198	219
32	126	150	151	175	176	200	201	225
40	143	171	168	196	193	221	218	246

\* Constructed of pins, flat washers and hexagon socket head cap bolts.  
\* Other dimensions are the same as basic type.

\* Constructed of pins, flat washers and hexagon socket head cap bolts.  
\* Other dimensions are the same as basic type.

### Clevis: CG1DN

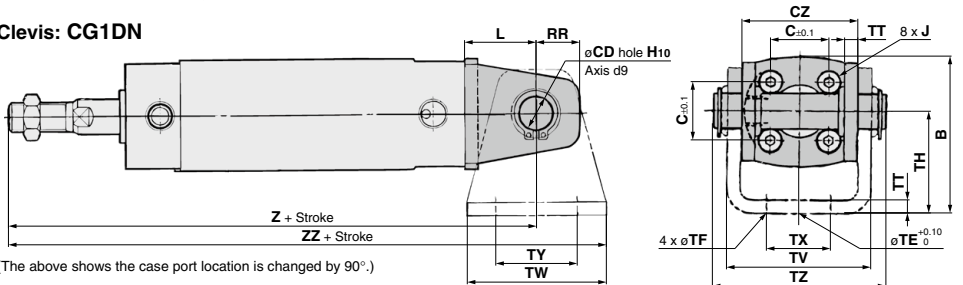

(The above shows the case port location is changed by 90°.)

#### Clevis

Bore size	Stroke range	B	CD	CZ	L	RR	TE	TF	TH	TT	TV	TW	TX	TY	TZ	ZZ			
																1 to 50 st	51 to 100 st	101 to 125 st	126 to 200 st
20	Up to 125	38	8	29	14	11	10	5.5	25	3.2	(35.8)	42	16	28	43.4	143	164	168	189
25	Up to 200	45.5	10	33	16	13	10	5.5	30	3.2	(39.8)	42	20	28	48	150	171	175	196
32	Up to 200	54	12	40	20	15	10	6.6	35	4.5	(49.4)	48	22	28	59.4	156	180	181	205
40	Up to 200	63.5	14	49	22	18	10	6.6	40	4.5	(58.4)	56	30	30	71.4	175	200	200	228

\* For dimensions of pivot bracket, refer to page 395.  
\* Other dimensions are the same as basic type.



# Air Cylinder: Non-rotating Rod Type Double Acting

## CG1K Series

ø20, ø25, ø32, ø40, ø50, ø63

RoHS

### How to Order

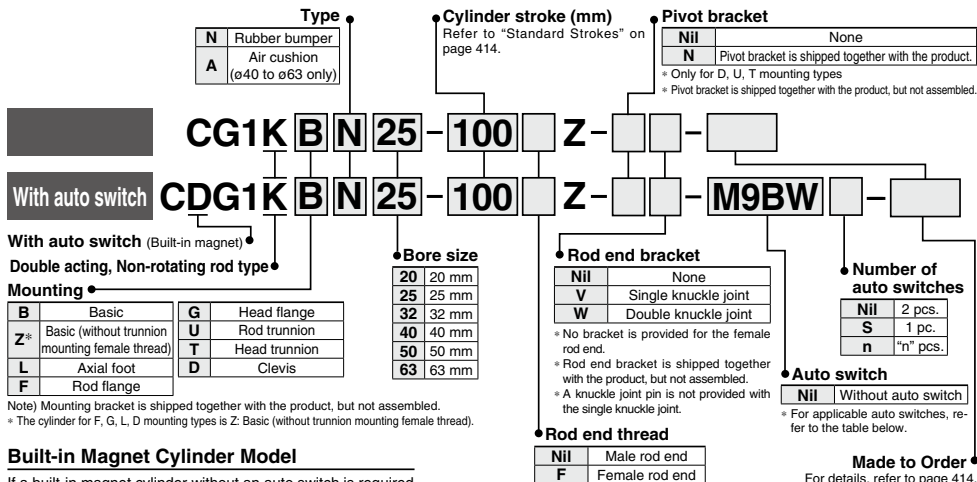

### Built-in Magnet Cylinder Model

If a built-in magnet cylinder without an auto switch is required, there is no need to enter the symbol for the auto switch.

(Example) CDG1KFA32-100Z

\* Refer to "Ordering Example of Cylinder Assembly" on page 414.

### Applicable Auto Switches/Refer to pages 1271 to 1365 for further information on auto switches.

Type	Special function	Electrical entry	Indicator light	Wiring (Output)	Load voltage		Auto switch model		Lead wire length (m)					Pre-wired connector	Applicable load			
					DC	AC	Applicable bore size		0.5 (Nil)	1 (M)	3 (L)	5 (Z)	None (N)					
							ø20 to ø63											
Solid state auto switch	—	Grommet	—	3-wire (NPN)	5 V, 12 V	—	M9NV	M9N	●	●	○	—	—	—	IC circuit			
				3-wire (PNP)			M9PV	M9P	●	●	○	—	—					
	Diagnostic indication (2-color indicator)	Connector	—	2-wire	12 V	—	M9BV	M9B	●	●	○	—	—	—				
				—			H7C	●	●	○	●	●	—					
	Water resistant (2-color indicator)	Grommet	Yes	3-wire (NPN)	5 V, 12 V	24 V	—	M9NVV	M9NV	●	●	○	—	—	IC circuit			
				3-wire (PNP)				M9PVV	M9PV	●	●	○	—	—				
	Diagnostic output (2-color indicator)	Grommet	—	2-wire	12 V	—	—	M9BWW	M9BW	●	●	○	—	—	—			
				3-wire (NPN)				M9NAV <sup>*1</sup>	M9NA <sup>*1</sup>	○	○	○	—	—		—	IC circuit	
	—	Grommet	—	3-wire (PNP)	5 V, 12 V	—	—	M9PAV <sup>*1</sup>	M9PA <sup>*1</sup>	○	○	○	—	—	IC circuit			
				2-wire				M9BAV <sup>*1</sup>	M9BA <sup>*1</sup>	○	○	○	—	—				
Reed auto switch	—	Grommet	Yes	3-wire (Equip. to NPN)	5 V	—	A96V	A96	●	—	●	—	—	—	IC circuit			
				No			24 V	12 V	100 V	A93V <sup>*2</sup>	A93	●	●	●		●	—	—
									100 V or less	A90V	A90	●	—	●		—	—	
				Yes			24 V	12 V	100 V, 200 V	—	B54	●	—	●		—	—	—
									200 V or less	—	B64	●	—	●		—	—	
				No			24 V	12 V	—	—	C73C	●	—	●		●	—	—
									24 V or less	—	C80C	●	—	●		●	—	
Diagnostic indication (2-color indicator)	Grommet	Yes	—	—	—	—	B59W	●	—	●	—	—	—	—				

\*1 Water resistant type auto switches can be mounted on the above models, but in such case SMC cannot guarantee water resistance.

Please consult with SMC regarding water resistant types with the above model numbers.

\*2 1 m type lead wire is only applicable to D-A93.

\* Lead wire length symbols: 0.5 m..... Nil (Example) M9NVW      5 m..... Z (Example) M9NVWZ  
 1 m..... M (Example) M9NVWM      None..... N (Example) H7CN  
 3 m..... L (Example) M9NVWL

\* Solid state auto switches marked with "○" are produced upon receipt of order.

\* Since there are other applicable auto switches than listed above, refer to page 446 for details.

\* For details about auto switches with pre-wired connector, refer to pages 1340 and 1341.

\* The D-A93□□/M9□□□ auto switches are shipped together, (but not assembled). (However, only the auto switch mounting brackets are assembled before shipment.)

# CG1K Series



## Symbol

Rubber bumper

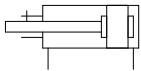

Air cushion

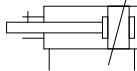

**Made to Order**  
Click here for details

Symbol	Specifications
-XA□	Change of rod end shape
-XC8	Adjustable stroke cylinder/Adjustable extension type*1
-XC9	Adjustable stroke cylinder/Adjustable retraction type*1
-XC10	Dual stroke cylinder/Double rod type
-XC11	Dual stroke cylinder/Single rod type*1
-XC12	Tandem cylinder*1
-XC13	Auto switch rail mounting*1
-XC20	Head cover axial port*1
-XC27	Double clevis and double knuckle joint pins made of stainless steel

\*1 Only compatible with cylinders with rubber bumper.

Refer to pages 440 to 446 for cylinders with auto switches.

- Auto switch proper mounting position (detection at stroke end) and its mounting height
- Minimum stroke for auto switch mounting
- Auto switch mounting brackets/Part no.
- Operating range
- Cylinder mounting bracket, by stroke/ Auto switch mounting surfaces



## Precautions

Refer to page 448 before handling.

## Specifications

Bore size (mm)	20	25	32	40	50	63
<b>Action</b>	Double acting, Single rod					
<b>Lubricant</b>	Not required (Non-lube)					
<b>Fluid</b>	Air					
<b>Proof pressure</b>	1.5 MPa					
<b>Maximum operating pressure</b>	1.0 MPa					
<b>Minimum operating pressure</b>	0.05 MPa					
<b>Ambient and fluid temperature</b>	Without auto switch: -10°C to 70°C With auto switch : -10°C to 60°C (No freezing)					
<b>Piston speed</b>	50 to 500 mm/s					
<b>Stroke length tolerance</b>	Up to 1000 st <sup>+1.4</sup> <sub>0</sub> mm, Up to 1500 st <sup>+1.8</sup> <sub>0</sub> mm					
<b>Cushion</b>	Rubber bumper, Air cushion (ø40 to ø63 only)					
<b>Rod non-rotating accuracy</b> (Note)	±1°	±0.8°				±0.5°
<b>Mounting</b>	Basic, Basic (without trunnion mounting female thread), Axial foot, Rod flange, Head flange, Rod trunnion, Head trunnion, Clevis					

Note) The values are for standard strokes.

## Accessories

Refer to page 395 for part numbers and dimensions.

Mounting		Basic	Axial foot	Rod flange	Head flange	Rod trunnion	Head trunnion	Clevis
Standard	Rod end nut	●	●	●	●	●	●	●
	Clevis pin	—	—	—	—	—	—	●
Option	Single knuckle joint	●	●	●	●	●	●	●
	Double knuckle joint*1 (With pin)	●	●	●	●	●	●	●
	Pivot bracket	—	—	—	—	●	●	●

\*1 A double knuckle joint pin and retaining rings are shipped together.

\*2 Stainless steel mounting brackets and accessories are also available. Refer to page 396 for details.

## Standard Strokes

Bore size	Standard stroke (Note 1)		Manufacturable stroke (mm)
	20	25, 50, 75, 100, 125, 150, 200	
25			1 to 1500
32			
40		25, 50, 75, 100, 125, 150, 200, 250, 300	1 to 1500
50, 63			

Note 1) Manufacture of intermediate strokes at 1 mm intervals is possible. (Spacers are not used.)

Note 2) Applicable strokes should be confirmed according to the usage. For details, refer to "Air Cylinders Model Selection" on pages 8 to 19. In addition, the products that exceed the standard stroke might not be able to fulfill the specifications due to the deflection etc.

## Ordering Example of Cylinder Assembly

Cylinder model: CDG1KDN20-100Z-NW-M9BW

**Mounting**      **D:** Clevis  
**Pivot bracket**    **N:** Yes  
**Rod end bracket**   **W:** Double knuckle joint  
**Auto switch D-M9BW:** 2 pcs.

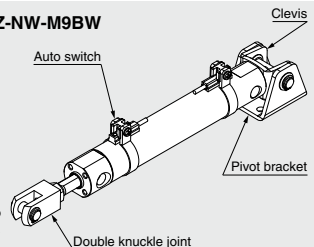

\*Pivot bracket, double knuckle joint and auto switch are shipped together with the product, but not assembled.

## Weights

		(kg)					
Bore size (mm)		20	25	32	40	50	63
Basic weight	Basic	0.10	0.17	0.26	0.41	0.77	1.07
	Axial foot	0.21	0.30	0.42	0.63	1.25	1.79
	Flange	0.18	0.27	0.40	0.61	1.11	1.57
	Trunnion	0.11	0.19	0.29	0.46	0.91	1.21
	Clevis	0.15	0.25	0.41	0.64	1.17	1.75
Pivot bracket		0.08	0.09	0.17	0.25	0.44	0.80
Single knuckle joint		0.05	0.09	0.09	0.10	0.22	0.22
Double knuckle joint (with pin)		0.05	0.09	0.09	0.13	0.26	0.26
Additional weight per 50 mm of stroke		0.05	0.07	0.09	0.15	0.22	0.26
Additional weight with air cushion		—	—	—	0	0.01	0.04
Additional weight for long stroke		0.01	0.01	0.02	0.03	0.06	0.12
Weight reduction for female rod end		-0.01	-0.02	-0.02	-0.05	-0.10	-0.10

Calculation (Example) **CG1KLN20-100Z** (Foot, ø20, 100 stroke)

- Basic weight ..... 0.21 (Foot, ø20)
- Additional weight ..... 0.05/50 stroke
- Air cylinder stroke ..... 100 stroke

$0.21 + 0.05 \times 100/50 = 0.31 \text{ kg}$

## Mounting Brackets/Part No.

Mounting bracket	Order q'ty.	Bore size (mm)						Contents
		20	25	32	40	50	63	
Axial foot	2 Note)	CG-L020	CG-L025	CG-L032	CG-L040	CG-L050	CG-L063	2 feets, 8 mounting bolts
Flange	1	CG-F020	CG-F025	CG-F032	CG-F040	CG-F050	CG-F063	1 flange, 4 mounting bolts
Trunnion pin	1	CG-T020	CG-T025	CG-T032	CG-T040	CG-T050	CG-T063	2 trunnion pins, 2 trunnion bolts, 2 flat washers
Clevis	1	CG-D020	CG-D025	CG-D032	CG-D040	CG-D050	CG-D063	1 clevis, 4 mounting bolts, 1 clevis pin, 2 retaining rings
Pivot bracket	1	CG-020-24A	CG-025-24A	CG-032-24A	CG-040-24A	CG-050-24A	CG-063-24A	1 pivot bracket

Note) Order two foots per cylinder.

# CG1K Series

## Construction

### With rubber bumper

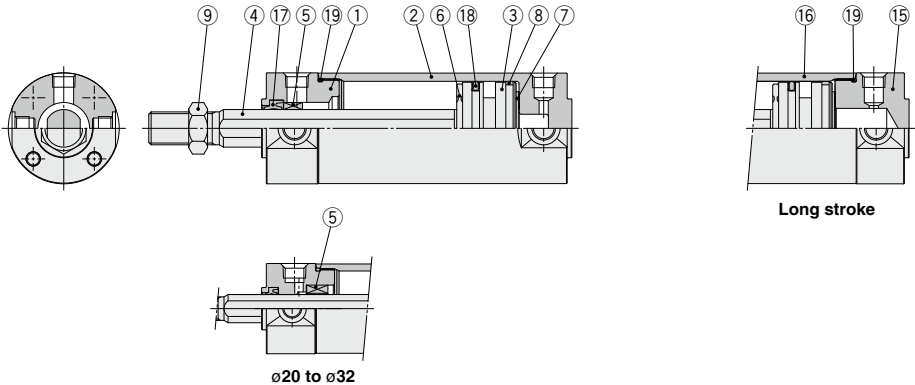

### With air cushion

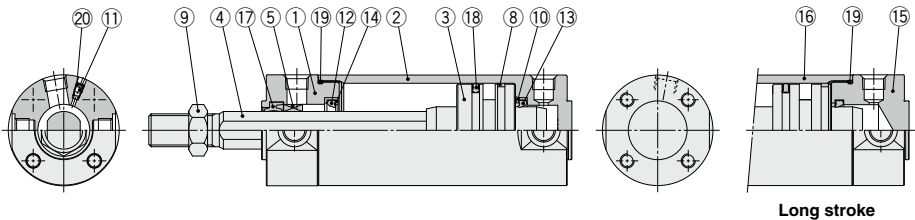

### Component Parts

No.	Description	Material	Note	
1	Rod cover	Aluminum alloy	Anodized	
2	Tube cover	Aluminum alloy	Hard anodized	
3	Piston	Aluminum alloy		
4	Piston rod	Stainless steel Carbon steel*	For ø20 or ø25 with built-in magnet Hard chrome plating*	
5	Non-rotating guide	Bearing alloy		
6	Bumper	Resin	ø32 or larger is common.	
7	Bumper	Resin		
8	Wear ring	Resin		
9	Rod end nut	Carbon steel	Zinc chromated	
10	Seal retainer	Rolled steel	Zinc chromated	
11	Cushion valve	ø40 or smaller	Carbon steel	Electroless nickel plating
		ø50 or larger	Steel wire	Zinc chromated
12	Cushion seal A	Urethane	ø32 or larger is common.	
13	Cushion seal B	Urethane		
14	Cushion seal holder	Aluminum alloy		
15	Head cover	Aluminum alloy	Anodized	
16	Cylinder tube	Aluminum alloy	Hard anodized	
17	Rod seal	NBR		
18	Piston seal	NBR		
19	Tube gasket	NBR		
20	Valve seal	NBR		

Note) For cylinders with auto switches, the magnet is installed in the piston.

\* The material is stainless steel for ø20 to ø32.

### Replacement Parts: Seal Kit

Bore size (mm)	Kit no.	Contents
20	CG1KN20Z-PS	Set of the nos. 17, 18, 19
25	CG1KN25Z-PS	
32	CG1KN32Z-PS	
40	CG1KN40Z-PS	

Note) As sizes ø50 and larger cannot be disassembled, the seal cannot be replaced.

Note) Refer to the Specific Product Precautions on page 448 for Disassembly/Replacement.

\* The seal kit includes a grease pack (10 g).

Order with the following part number when only the grease pack is needed.

**Grease pack part number: GR-S-010 (10 g)**

**Basic**

**With rubber bumper**

ø20 to ø63

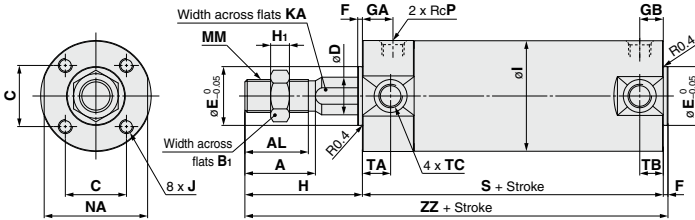

**With air cushion**

ø40 to ø63

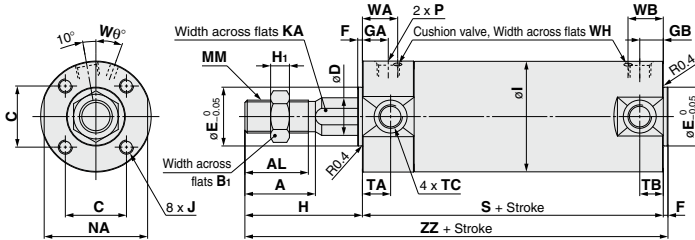

**With Air Cushion** (mm)

Bore size	WA	WB	Wθ	WH
40	17	15 (17)	20°	1.5
50	18	16 (18)	20°	3
63	18	17 (18)	20°	3

Note) ( ): Denotes the dimensions for long stroke.

**Female rod end**

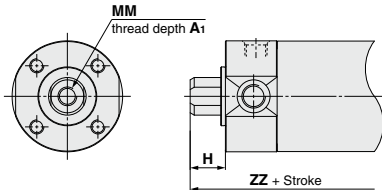

**Female Rod End** (mm)

Bore size	A <sub>1</sub>	H	MM	ZZ
20	8	13	M4 x 0.7	84 (92)
25	8	14	M5 x 0.8	85 (93)
32	12	14	M6 x 1	87 (95)
40	13	15	M8 x 1.25	95 (104)
50	18	16	M10 x 1.5	108 (120)
63	18	16	M10 x 1.5	108 (120)

Bore size	Stroke range		A	AL	B <sub>1</sub>	C	D	E	F	GA	GB	H	H <sub>1</sub>	I	J	KA	MM	NA	P	S	TA	TB	TC	ZZ
	Standard	Long stroke																						
20	Up to 200	201 to 1500	18	15.5	13	14	9.2	12	2	12	10 (12)	35	5	26	M4 x 0.7 depth 7	8	M8 x 1.25	24	1/8	69 (77)	11	11	M5 x 0.8	106 (114)
25	Up to 300	301 to 1500	22	19.5	17	16.5	11	14	2	12	10 (12)	40	6	31	M5 x 0.8 depth 7.5	10	M10 x 1.25	29	1/8	69 (77)	11	11	M6 x 0.75	111 (119)
32	Up to 300	301 to 1500	22	19.5	17	20	12	18	2	12	10 (12)	40	6	38	M5 x 0.8 depth 8	10	M10 x 1.25	35.5	1/8	71 (79)	11	10 (11)	M8 x 1.0	113 (121)
40	Up to 300	301 to 1500	30	27	19	26	16	25	2	13	10 (13)	50	8	47	M6 x 1 depth 12	14	M14 x 1.5	44	1/8	78 (87)	12	10 (12)	M10 x 1.25	130 (139)
50	Up to 300	301 to 1500	35	32	27	32	20	30	2	14	12 (14)	58	11	58	M8 x 1.25 depth 16	18	M18 x 1.5	55	1/4	90 (102)	13	12 (13)	M12 x 1.25	150 (162)
63	Up to 300	301 to 1500	35	32	27	38	20	32	2	14	12 (14)	58	11	72	M10 x 1.5 depth 16	18	M18 x 1.5	59	1/4	90 (102)	13	12 (13)	M14 x 1.5	150 (162)

Note 1) Dimensions for each mounting bracket are the same as those for the CG1 standard or long stroke model. Refer to pages 387 to 393.

Note 2) ( ): Denotes the dimensions for long stroke.

# Air Cylinder: Non-rotating Rod Type Double Acting, Double Rod

# CG1KW Series

ø20, ø25, ø32, ø40, ø50, ø63

RoHS

## How to Order

**CG1KW L N 25 - 100 Z**

**With auto switch CDG1KW L N 25 - 100 Z - M9BW**

With auto switch (Built-in magnet)  
Non-rotating rod type  
Double acting, Double rod type  
Mounting  
Type  
Bore size  
Cylinder stroke (mm)

<b>B</b>	Basic
<b>Z*</b>	Basic (without trunnion mounting female thread)
<b>L</b>	Axial foot
<b>F</b>	Flange
<b>U</b>	Trunnion

<b>N</b>	Rubber bumper
----------	---------------

<b>20</b>	20 mm
<b>25</b>	25 mm
<b>32</b>	32 mm
<b>40</b>	40 mm
<b>50</b>	50 mm
<b>63</b>	63 mm

<b>Nil</b>	2 pcs.
<b>S</b>	1 pc.
<b>n</b>	"n" pcs.

<b>Nil</b>	Without auto switch
------------	---------------------

\* For applicable auto switches, refer to the table below.

\* Mounting bracket is shipped together with the product, but not assembled.  
\* The cylinder for F, L mounting types is Z: Basic (without trunnion mounting female thread).

Refer to "Standard Strokes" on page 419.

### Built-in Magnet Cylinder Model

If a built-in magnet cylinder without an auto switch is required, there is no need to enter the symbol for the auto switch.  
(Example) CDG1KWFN32-100Z

### Applicable Auto Switches/Refer to pages 1271 to 1365 for further information on auto switches.

Type	Special function	Electrical entry	Indicator light	Wiring (Output)	Load voltage		Auto switch model		Lead wire length (m)					Pre-wired connector	Applicable load								
					DC	AC	Applicable bore size		0.5 (Nil)	1 (M)	3 (L)	5 (Z)	None (N)										
							ø20 to ø63	Perpendicular								In-line							
Solid state auto switch	—	Grommet	—	3-wire (NPN)	5 V, 12 V	—	M9NV	M9N	●	●	●	○	—	○	IC circuit	Relay, PLC							
				3-wire (PNP)					M9PV	M9P	●	●	●	○			—	○					
		Connector	2-wire	12 V	—	M9BV	M9B	●	●	●	○	—	○										
			—					H7C	●	—	●	●	—	—									
	Diagnostic indication (2-color indicator)	Grommet	Yes	3-wire (NPN)	5 V, 12 V	—	M9NVV	M9NW	●	●	●	○	—	○	IC circuit								
				3-wire (PNP)					M9PVV	M9PW	●	●	●	○			—	○					
	Water resistant (2-color indicator)	Grommet	—	3-wire (NPN)	5 V, 12 V	—	M9NAV <sup>*1</sup>	M9NA <sup>*1</sup>	○	○	○	○	—	○	IC circuit								
				3-wire (PNP)					M9PAV <sup>*1</sup>	M9PA <sup>*1</sup>	○	○	●	○			—	○					
	Diagnostic output (2-color indicator)	Grommet	—	2-wire	12 V	—	M9BAV <sup>*1</sup>	M9BA <sup>*1</sup>	○	○	●	○	—	○	IC circuit								
				4-wire (NPN)					—	H7FN	●	—	●	○			—	○					
Reed auto switch	—	Grommet	Yes	3-wire (Equiv. to NPN)	—	5 V	—	A96V	A96	●	—	●	—	—	—	IC circuit							
										No	24 V	12 V	100 V	A93V <sup>*2</sup>	A93		●	●	●	●	—	—	
													100 V or less	A90V	A90		●	—	●	—	—	—	IC circuit
													100 V, 200 V	—	B54		●	—	●	●	—	—	
		Connector	No	24 V	12 V	200 V or less	—	B64	●	—	●	—	—	—									
						—	—	C73C	●	—	●	●	—		—								
						24 V or less	—	C80C	●	—	●	●	—		—	IC circuit							
						—	—	B59W	●	—	●	—	—		—								

\*1 Water resistant type auto switches can be mounted on the above models, but in such case SMC cannot guarantee water resistance. Please consult with SMC regarding water resistant types with the above model numbers.  
\*2 1 m type lead wire is only applicable to D-A93.  
\* Lead wire length symbols: 0.5 m..... Nil (Example) M9NV 5 m..... Z (Example) M9NVZ \* Solid state auto switches marked with "○" are produced upon receipt of order.  
\* Since there are other applicable auto switches than listed above, refer to page 446 for details.  
\* For details about auto switches with pre-wired connector, refer to pages 1340 and 1341.  
\* The D-A90□□/M9□□□ auto switches are shipped together, (but not assembled). (However, only the auto switch mounting brackets are assembled before shipment.)

# Air Cylinder: Non-rotating Rod Type Double Acting, Double Rod **CG1KW Series**



## Symbol

Rubber bumper

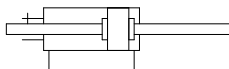

Refer to pages 440 to 446 for cylinders with auto switches.

- Auto switch proper mounting position (detection at stroke end) and its mounting height
- Minimum stroke for auto switch mounting
- Auto switch mounting brackets/Part no.
- Operating range
- Cylinder mounting bracket, by stroke/ Auto switch mounting surfaces



## Precautions

**Refer to page 448 before handling.**

## Specifications

Bore size (mm)	20	25	32	40	50	63
<b>Action</b>	Double acting, Double rod					
<b>Lubricant</b>	Not required (Non-lube)					
<b>Fluid</b>	Air					
<b>Proof pressure</b>	1.5 MPa					
<b>Maximum operating pressure</b>	1.0 MPa					
<b>Minimum operating pressure</b>	0.08 MPa					
<b>Ambient and fluid temperature</b>	Without auto switch: -10°C to 70°C (No freezing) With auto switch : -10°C to 60°C					
<b>Piston speed</b>	50 to 500 mm/s					
<b>Stroke length tolerance</b>	Up to 1000 st <sup>+1.4</sup> <sub>0</sub> mm, Up to 1500 st <sup>+1.8</sup> <sub>0</sub> mm					
<b>Cushion</b>	Rubber bumper					
<b>Rod non-rotating accuracy <sup>Note)</sup></b>	±1°		±0.8°			±0.5°
<b>Mounting</b>	Basic, Basic (without trunnion mounting female thread), Axial foot, Flange, Trunnion					

\* Foot and flange types of cylinder sizes from ø20 to ø63 do not have trunnion mounting female thread. Operate the cylinder within the allowable kinetic energy. Refer to page 399 for details. Note) The values are for standard strokes.

## Accessories

Refer to page 395 for part numbers and dimensions.

Mounting		Basic	Axial foot	Flange	Trunnion
Standard	Rod end nut	●	●	●	●
	Single knuckle joint	●	●	●	●
Option	Double knuckle joint (with pin) <sup>*1</sup>	●	●	●	●
	Pivot bracket	—	—	—	●

\*1 A double knuckle joint pin and retaining rings are shipped together.

\*2 Stainless steel mounting brackets and accessories are also available. Refer to page 396 for details.

## Weights

Bore size (mm)		20	25	32	40	50	63
Basic weight	Basic	0.13	0.22	0.33	0.55	1.02	1.37
	Axial foot	0.24	0.35	0.49	0.77	1.50	2.09
	Flange	0.21	0.32	0.47	0.75	1.36	1.87
	Trunnion	0.14	0.24	0.36	0.60	1.16	1.51
Pivot bracket		0.08	0.09	0.17	0.25	0.44	0.80
Single knuckle joint		0.05	0.09	0.09	0.10	0.22	0.22
Double knuckle joint (with pin)		0.05	0.09	0.09	0.13	0.26	0.26
Additional weight per 50 mm of stroke		0.07	0.10	0.13	0.23	0.34	0.38
Weight reduction for female rod end		-0.02	-0.04	-0.04	-0.10	-0.20	-0.20

Calculation (Example) **CG1KWLN32-100Z**

- Basic weight.....0.49 (Foot, ø32)
- Additional weight.....0.13/50 stroke
- Air cylinder stroke.....100 stroke

$0.49 + 0.13 \times 100/50 = 0.75 \text{ kg}$

## Standard Strokes

Bore size	Standard stroke <sup>Note 1)</sup>	Manufacturable stroke
<b>20</b>	25, 50, 75, 100, 125, 150, 200	1 to 1500
<b>25</b>		
<b>32</b>	25, 50, 75, 100, 125, 150, 200,	1 to 1500
<b>40</b>	250, 300	
<b>50, 63</b>		

Note 1) Manufacture of intermediate strokes at 1 mm intervals is possible. (Spacers are not used.)

Note 2) Applicable strokes should be confirmed according to the usage. For details, refer to "Air Cylinders Model Selection" on pages 8 to 19. In addition, the products that exceed the standard stroke might not be able to fulfill the specifications due to the deflection etc.

## Mounting Brackets/Part No.

Mounting bracket	Order q'ty	Bore size (mm)						Contents
		20	25	32	40	50	63	
Axial foot	2 <sup>Note)</sup>	CG-L020	CG-L025	CG-L032	CG-L040	CG-L050	CG-L063	2 foos, 8 mounting bolts
Flange	1	CG-F020	CG-F025	CG-F032	CG-F040	CG-F050	CG-F063	1 flange, 4 mounting bolts
Trunnion pin	1	CG-T020	CG-T025	CG-T032	CG-T040	CG-T050	CG-T063	2 trunnion pins, 2 trunnion bolts, 2 flat washers
Pivot bracket	1	CG-020-24A	CG-025-24A	CG-032-24A	CG-040-24A	CG-050-24A	CG-063-24A	1 pivot bracket

Note) Order two foos per cylinder.

# CG1KW Series

## Construction

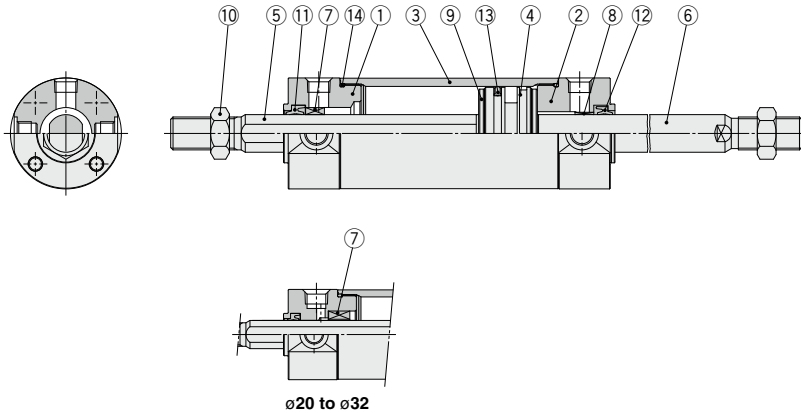

### Component Parts

No.	Description	Material	Note
1	Rod cover A	Aluminum alloy	Anodized
2	Rod cover B	Aluminum alloy	Anodized
3	Cylinder tube	Aluminum alloy	Hard anodized
4	Piston	Aluminum alloy	
5	Piston rod A	Stainless steel	ø32 or smaller
		Carbon steel*	Hard chrome plating* ø40 or larger
6	Piston rod B	Stainless steel	For ø20 or ø25 with built-in magnet
		Carbon steel**	Hard chrome plating*
7	Non-rotating guide	Bearing alloy	
8	Bushing	Bearing alloy	
9	Bumper	Resin	
10	Rod end nut	Carbon steel	Zinc chromated
11	Rod seal A	NBR	
12	Rod seal B	NBR	
13	Piston seal	NBR	
14	Tube gasket	NBR	

\* The material is stainless steel for ø20 to ø32.

\*\* The material for ø20, ø25 cylinders with auto switches is made of stainless steel.

\*\*\* For cylinders with auto switches, the magnet is installed in the piston.

### Replacement Parts: Seal Kit

Bore size (mm)	Kit no.	Contents
20	CG1KWN20Z-PS	Set of the nos. ⑪, ⑫, ⑬, ⑭
25	CG1KWN25Z-PS	
32	CG1KWN32Z-PS	
40	CG1KWN40Z-PS	

Note) As sizes ø50 and larger cannot be disassembled, the seal cannot be replaced.

Note) Refer to the Specific Product Precautions on page 448 for Disassembly/Replacement.

\* The seal kit includes a grease pack (10 g).  
Order with the following part number when only the grease pack is needed.

**Grease pack part number: GR-S-010 (10 g)**



**Basic with Rubber Bumper: CG1KWBN**

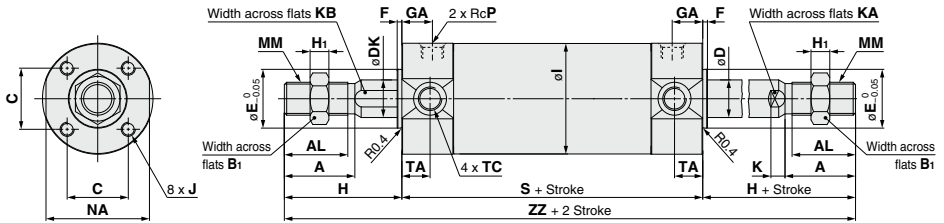

Bore size	Stroke range	A	AL	B <sub>1</sub>	C	D	DK	E	F	GA	H <sub>1</sub>	I	J	K	KA	KB	MM	NA	P	S
20	Up to 1500	18	15.5	13	14	8	9.2	12	2	12	5	26	M4 x 0.7 depth 7	5	6	8	M8 x 1.25	24	1/8	77
25	Up to 1500	22	19.5	17	16.5	10	11	14	2	12	6	31	M5 x 0.8 depth 7.5	5.5	8	10	M10 x 1.25	29	1/8	77
32	Up to 1500	22	19.5	17	20	12	12	18	2	12	6	38	M5 x 0.8 depth 8	5.5	10	10	M10 x 1.25	35.5	1/8	79
40	Up to 1500	30	27	19	26	16	16	25	2	13	8	47	M6 x 1 depth 12	6	14	14	M14 x 1.5	44	1/8	87
50	Up to 1500	35	32	27	32	20	20	30	2	14	11	58	M8 x 1.25 depth 16	7	18	18	M18 x 1.5	55	1/4	102
63	Up to 1500	35	32	27	38	20	20	32	2	14	11	72	M10 x 1.5 depth 16	7	18	18	M18 x 1.5	69	1/4	102

(mm)

Bore size	TA	TC	H	ZZ
20	11	M5 x 0.8	35	147
25	11	M6 x 0.75	40	157
32	11	M8 x 1.0	40	159
40	12	M10 x 1.25	50	187
50	13	M12 x 1.25	58	218
63	13	M14 x 1.5	58	218

Note 1) Dimensions are the same as those for the CG1W standard. Refer to pages 404 and 405.

# Air Cylinder: Direct Mount Type Double Acting

# CG1R Series

ø20, ø25, ø32, ø40, ø50, ø63

RoHS

## How to Order

**CG1R N 25 - 100 □ Z - □ - □**

**With auto switch** **CDG1R N 25 - 100 □ Z - □ - M9BW □ - □**

**With auto switch (Built-in magnet)**

**Type**

N	Rubber bumper
A	Air cushion

**Bore size**

20	20 mm
25	25 mm
32	32 mm
40	40 mm
50	50 mm
63	63 mm

**Cylinder stroke (mm)**

Refer to "Standard Strokes" on page 423.

**Rod end bracket**

Nil	None
V	Single knuckle joint
W	Double knuckle joint

\* No bracket is provided for the female rod end.  
\* Rod end bracket is shipped together with the product, but not assembled.  
\* A knuckle joint pin is not provided with the single knuckle joint.

**Number of auto switches**

Nil	2 pcs.
S	1 pc.
n	"n" pcs.

**Auto switch**

Nil	Without auto switch
-----	---------------------

\* For applicable auto switches, refer to the table below.

**Rod end thread**

Nil	Male rod end
F	Female rod end

**Made to Order**

For details, refer to page 423.

### Built-in Magnet Cylinder Model

If a built-in magnet cylinder without an auto switch is required, there is no need to enter the symbol for the auto switch.  
(Example) CDG1RA32-100Z

\* Refer to "Ordering Example of Cylinder Assembly" on page 423.

### Applicable Auto Switches

Refer to pages 1271 to 1365 for further information on auto switches.

Type	Special function	Electrical entry	Indicator light	Wiring (Output)	Load voltage		Auto switch model		Lead wire length (m)					Pre-wired connector	Applicable load	
					DC	AC	Applicable bore size		0.5 (Nil)	1 (M)	3 (L)	5 (Z)	None (N)			
							ø20 to ø63	Perpendicular								In-line
Solid state auto switch	—	Grommet	Yes	3-wire (NPN)	5 V, 12 V	—	M9NV	M9N	●	●	●	○	—	○	Relay, PLC	
				3-wire (PNP)			M9PV	M9P	●	●	●	○	—	○		
		2-wire		M9BV	M9B	●	●	●	○	—	○	—				
		—		H7C	●	—	●	●	—	—	—					
	Diagnostic indication (2-color indicator)	Grommet	Yes	3-wire (NPN)	5 V, 12 V	—	M9NWV	M9NW	●	●	●	○	—	○	IC circuit	
				3-wire (PNP)			M9PWW	M9PW	●	●	●	○	—	○		
	2-wire	M9BWW		M9BW	●	●	●	○	—	○	—					
	3-wire (NPN)	M9NAV <sup>*1</sup>		M9NA <sup>*1</sup>	○	○	●	○	—	○		IC circuit				
	3-wire (PNP)	M9PAV <sup>*1</sup>	M9PA <sup>*1</sup>	○	○	●	○	—	○	IC circuit						
	2-wire	M9BAV <sup>*1</sup>	M9BA <sup>*1</sup>	○	○	○	○	—	○		—					
4-wire (NPN)	H7NF	●	—	●	○	—	○	—	○	IC circuit						
Diagnostic output (2-color indicator)	—	—	—	—	—	—	—	—	—		—	—	—	—		
Reed auto switch	—	Grommet	Yes	3-wire (Equiv. to NPN)	5 V	—	A96V	A96	●	—	●	—	—	—	IC circuit	
							100 V	A93V <sup>*2</sup>	A93	●	●	●	—	—		—
							100 V or less	A90V	A90	●	—	●	—	—		
							100 V, 200 V	—	B54	●	—	●	—	—		—
		200 V or less		—	B64	●	—	●	—	—	—					
		—		—	C73C	●	—	●	—	—		—				
		24 V or less		—	C80C	●	—	●	—	—	IC circuit					
		—		—	B59W	●	—	●	—	—		—	—			

\*1 Water resistant type auto switches can be mounted on the above models, but in such case SMC cannot guarantee water resistance.

Please consult with SMC regarding water resistant types with the above model numbers.

\*2 1 m type lead wire is only applicable to D-A93.

\* Lead wire length symbols: 0.5 m..... Nil (Example) M9NW  
1 m..... M (Example) M9NWM  
3 m..... L (Example) M9NWL  
5 m..... Z (Example) M9NWZ  
None..... N (Example) H7CN

\* Solid state auto switches marked with "○" are produced upon receipt of order.

\* Since there are other applicable auto switches than listed above, refer to page 446 for details.

\* For details about auto switches with pre-wired connector, refer to pages 1340 and 1341.

\* The D-A9□□/M9□□□ auto switches are shipped together, (but not assembled). (However, only the auto switch mounting brackets are assembled before shipment.)

**The CG1R direct mount cylinder can be installed directly through the use of a square rod cover.**

### Space-saving has been realized.

Because it is a directly mounted type without using brackets, its overall length is shorter, and its installation pitch can be made smaller. Thus, the space that is required for installation has been dramatically reduced.



#### Symbol

Rubber bumper

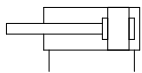

Air cushion

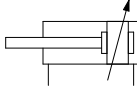

**Made to Order**  
[Click here for details](#)

Symbol	Specifications
-XA□	Change of rod end shape
-XB6	Heat resistant cylinder (-10 to 150°C)*2
-XB7	Cold resistant cylinder (-40 to 70°C)*1
-XB9	Low speed cylinder (10 to 50 mm/s)*1
-XB13	Low speed cylinder (5 to 50 mm/s)*1
-XC6	Made of stainless steel
-XC8	Adjustable stroke cylinder/Adjustable extension type*1
-XC9	Adjustable stroke cylinder/Adjustable retraction type*1
-XC13	Auto switch rail mounting*1
-XC20	Head cover axial port*1
-XC22	Fluororubber seal
-XC85	Grease for food processing equipment

\*1 Only compatible with cylinders with rubber bumper.

\*2 Cylinders with rubber bumper have no bumper.

Refer to pages 440 to 446 for cylinders with auto switches.

- Auto switch proper mounting position (detection at stroke end) and its mounting height
- Minimum stroke for auto switch mounting
- Auto switch mounting brackets/Part no.
- Operating range
- Cylinder mounting bracket, by stroke/ Auto switch mounting surfaces

## ⚠ Precautions

**Refer to page 448 before handling.**

## Specifications

Bore size (mm)	20	25	32	40	50	63
Action	Double acting, Single rod					
Lubricant	Not required (Non-lube)					
Fluid	Air					
Proof pressure	1.5 MPa					
Maximum operating pressure	1.0 MPa					
Minimum operating pressure	0.05 MPa					
Ambient and fluid temperature	Without auto switch: -10°C to 70°C (No freezing) With auto switch : -10°C to 60°C					
Piston speed	50 to 1000 mm/s					
Stroke length tolerance	Up to 300 st <sup>+1.4</sup> <sub>0</sub> mm					
Cushion	Rubber bumper, Air cushion					

## Standard Strokes

Bore size	Standard stroke* (mm)
20	25, 50, 75, 100, 125, 150
25, 32	25, 50, 75, 100, 125, 150, 200
40, 50, 63	25, 50, 75, 100, 125, 150, 200, 250, 300

\* Please consult with SMC for strokes which exceed the standard stroke length.

Note 1) Intermediate strokes not listed above are produced upon receipt of order.

Manufacture of intermediate strokes at 1 mm intervals is possible. (Spacers are not used.)

Note 2) Applicable strokes should be confirmed according to the usage. For details, refer to "Air Cylinders Model Selection" on pages 8 to 19. In addition, the products that exceed the standard stroke might not be able to fulfill the specifications due to the deflection etc.

**Tightening Torque:** Tighten the cylinder mounting bolts with the following tightening torque.

Bore size (mm)	Hexagon socket head cap screw size	Tightening torque (N·m)
20	M5 x 0.8	2.4 to 3.6
25	M6	4.2 to 6.2
32	M8	10.0 to 15.0
40	M10	19.6 to 29.4
50	M12	33.6 to 50.4
63	M16	84.8 to 127.2

## Ordering Example of Cylinder Assembly

Cylinder model: CDG1R20-100Z-W-M9BW

Rod end bracket W: Double knuckle joint  
Auto switch D-M9BW: 2 pcs.

\* Double knuckle joint and auto switch are shipped together with the product, but not assembled.

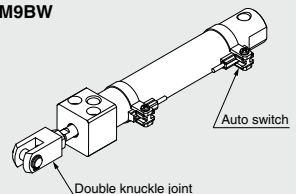

# CG1R Series

## Weights

Bore size (mm)	20	25	32	40	50	63
Basic weight	0.14	0.23	0.35	0.57	1.04	1.49
Single knuckle joint	0.05	0.09	0.09	0.10	0.22	0.22
Double knuckle joint (with pin)	0.05	0.09	0.09	0.13	0.26	0.26
Additional weight per 50 mm of stroke	0.05	0.07	0.09	0.14	0.21	0.25
Additional weight with air cushion	0	0.01	0.04	0	0.01	0.04
Weight reduction for female rod end	-0.01	-0.02	-0.02	-0.05	-0.10	-0.10

(kg)

Calculation (Example) **CG1RN32-100Z**  
(ø32, 100 stroke)

- Basic weight ..... 0.35
  - Additional weight ..... 0.09/50 stroke
  - Air cylinder stroke ..... 100 stroke
- 
- $0.35 + 0.09 \times 100/50 = 0.53 \text{ kg}$

## Accessories

Mounting		Basic
Standard	Rod end nut	●
Option	Single knuckle joint	●
	Double knuckle joint* <sup>1</sup> (with pin)	●

\*1 A double knuckle joint pin and retaining rings are shipped together.

\*2 Refer to page 395 for part numbers and dimensions of the accessories.

\*3 Stainless steel accessories are also available. Refer to page 396 for details.

## Construction

### With rubber bumper

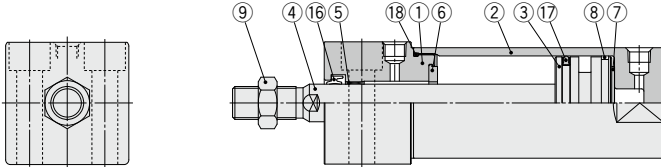

### With air cushion

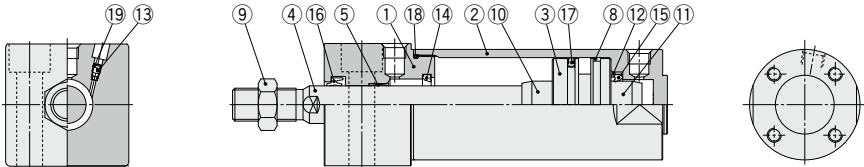

### Component Parts

No.	Description	Material	Note
1	Rod cover	Aluminum alloy	Anodized
2	Tube cover	Aluminum alloy	Hard anodized
3	Piston	Aluminum alloy	
4	Piston rod	Stainless steel	For ø20 or ø25 with built-in magnet
		Carbon steel*	Hard chrome plating*
5	Bushing	Bearing alloy	
6	Bumper	Resin	ø32 or larger is common.
7	Bumper	Resin	
8	Wear ring	Resin	
9	Rod end nut	Carbon steel	Zinc chromated
10	Cushion ring A	Aluminum alloy	

No.	Description	Material	Note
11	Cushion ring B	Aluminum alloy	
12	Seal retainer	Rolled steel	Zinc chromated
13	Cushion valve	ø40 or smaller	Carbon steel
		ø50 or larger	Steel wire
14	Cushion seal A	Urethane	ø32 or larger is common.
15	Cushion seal B	Urethane	
16	Rod seal	NBR	
17	Piston seal	NBR	
18	Tube gasket	NBR	
19	Valve seal	NBR	

Note) For cylinders with auto switches, the magnet is installed in the piston.  
\* The material for ø20, ø25 cylinders with auto switches is made of stainless steel.

Replacement parts/Seal kit are the same as standard type, double acting, single rod. Refer to page 384.

Note) As sizes ø50 and larger cannot be disassembled, the seal cannot be replaced.

Note) Refer to the Specific Product Precautions on page 448 for Disassembly/Replacement.

# CG1R Series

## Basic with Bottom Mounting

### With rubber bumper

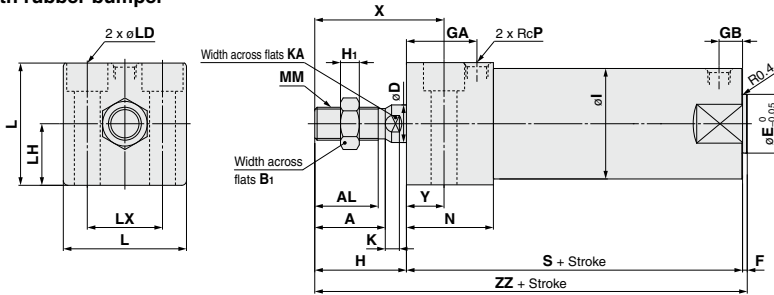

### With air cushion

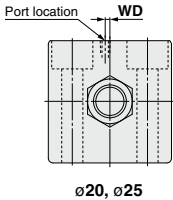
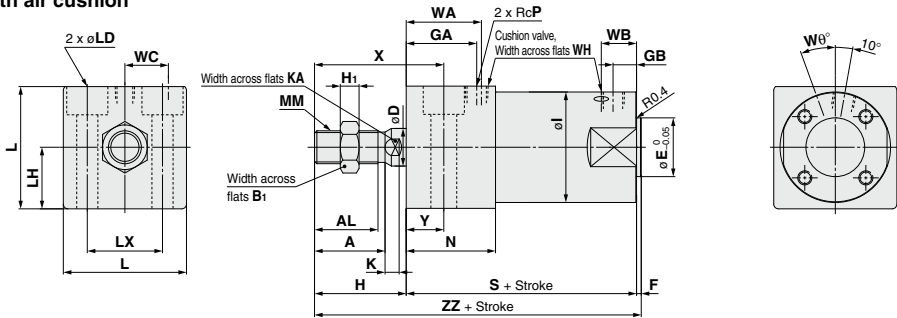

### Female rod end

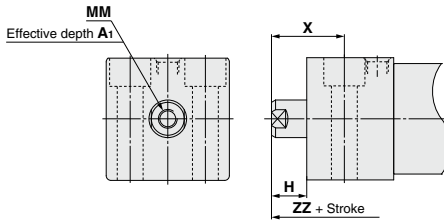

Bore size	Stroke range	A	AL	B <sub>1</sub>	D	E	F	GA	GB	H	H <sub>1</sub>	I	K	KA	L	LD	LH	LX	MM	N	P	S	X	Y	ZZ
20	Up to 150	18	15.5	13	8	12	2	20	10	27	5	26	5	6	30.4	ø5.5, ø9.5 depth of counterbore 6	15	18	M8 x 1.25	27	1/8	75	38	11	104
25	Up to 200	22	19.5	17	10	14	2	22	10	32	6	31	5.5	8	36.4	ø6.6, ø11 depth of counterbore 7	18	22	M10 x 1.25	29	1/8	77	44	12	111
32	Up to 200	22	19.5	17	12	18	2	26	10	32	6	38	5.5	10	42.4	ø9, ø14 depth of counterbore 9	21	24	M10 x 1.25	33	1/8	83	45	13	117
40	Up to 300	30	27	19	16	25	2	30	10	39	8	47	6	14	52.4	ø11, ø17.5 depth of counterbore 12	26	32	M14 x 1.5	37	1/8	94	55	16	135
50	Up to 300	35	32	27	20	30	2	33	12	45	11	58	7	18	64.5	ø14, ø20 depth of counterbore 14	32	41	M18 x 1.5	44	1/4	108	62	17	155
63	Up to 300	35	32	27	20	32	2	39	12	45	11	72	7	18	76.6	ø18, ø26 depth of counterbore 18	38	46	M18 x 1.5	50	1/4	114	64	19	161

### With Air Cushion

Bore size	Stroke range	P	WA	WB	WC	WD	Wø	WH
20	Up to 150	M5 x 0.8	22	15	5.5	2	25°	1.5
25	Up to 200	M5 x 0.8	24	14.5	7	2	25°	1.5
32	Up to 200	Rc1/8	28	14	11.5	—	25°	1.5
40	Up to 300	Rc1/8	32	15	15	—	20°	1.5
50	Up to 300	Rc1/4	36	16	17.5	—	20°	3
63	Up to 300	Rc1/4	42	17	20.5	—	20°	3

### Female Rod End

Bore size	A <sub>1</sub>	H	MM	X	ZZ
20	8	13	M4 x 0.7	24	90
25	8	14	M5 x 0.8	26	93
32	12	14	M6 x 1	27	99
40	13	15	M8 x 1.25	31	111
50	18	16	M10 x 1.5	33	126
63	18	16	M10 x 1.5	35	132

# Air Cylinder: Direct Mount, Non-rotating Rod Type

# CG1KR Series

ø20, ø25, ø32, ø40, ø50, ø63



## How to Order

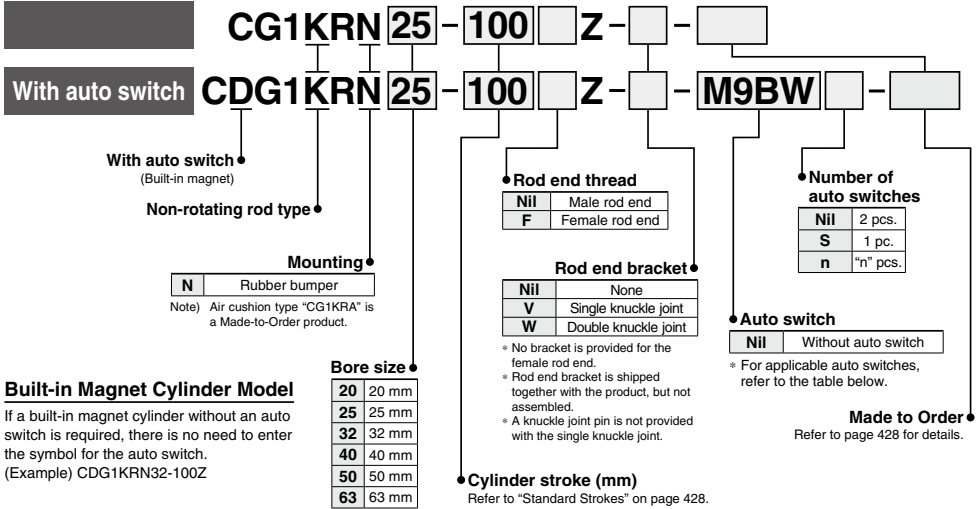

### Built-in Magnet Cylinder Model

If a built-in magnet cylinder without an auto switch is required, there is no need to enter the symbol for the auto switch.  
(Example) CDG1KRN32-100Z

### Applicable Auto Switches

Refer to pages 1271 to 1365 for further information on auto switches.

Type	Special function	Electrical entry	Indicator/light	Wiring (Output)	Load voltage		Auto switch model		Lead wire length (m)					Pre-wired connector	Applicable load				
					DC	AC	Applicable bore size ø20 to ø63		0.5 (Nil)	1 (M)	3 (L)	5 (Z)	None (N)		IC circuit	Relay, PLC			
							Perpendicular	In-line											
Solid state auto switch	—	Grommet	—	3-wire (NPN)	5 V, 12 V	—	M9NV	M9N	●	●	●	○	—	○	IC circuit	Relay, PLC			
				3-wire (PNP)			M9PV	M9P	●	●	●	○	—	○					
	Diagnostic indication (2-color indicator)	Connector	Yes	2-wire	12 V	—	M9BV	M9B	●	●	●	○	—	○	—				
				—			H7C	●	—	●	●	—	—	—					
	Water resistant (2-color indicator)	Grommet	—	3-wire (NPN)	5 V, 12 V	—	M9NVV	M9NV	●	●	●	○	—	○	IC circuit				
				3-wire (PNP)			M9PVV	M9PV	●	●	●	○	—	○					
	Diagnostic output (2-color indicator)	Grommet	—	—	2-wire	12 V	—	M9BWW	M9BW	●	●	●	○	—	○		—		
					3-wire (NPN)			M9NAV <sup>*1</sup>	M9NA <sup>*1</sup>	○	○	○	○	—	○		IC circuit		
3-wire (PNP)					M9PAV <sup>*1</sup>			M9PA <sup>*1</sup>	○	○	○	○	—	○	IC circuit				
2-wire					M9BAV <sup>*1</sup>			M9BA <sup>*1</sup>	○	○	○	○	—	○	—				
Reed auto switch	—	Grommet	Yes	3-wire (Equiv. to NPN)	—	5 V	—	A96V	A96	●	—	●	—	—	—	IC circuit	Relay, PLC		
				No				100 V	A93V <sup>*2</sup>	A93	●	●	●	●	—	—		—	
								100 V or less	A90V	A90	●	—	—	—	—	—		IC circuit	
								100 V, 200 V	—	B54	●	—	●	●	—	—		—	
		Connector	No	2-wire	24 V	12 V	—	—	200 V or less	—	B64	●	—	—	—	—		—	
									—	—	C73C	●	—	●	●	—		—	—
									24 V or less	—	C80C	●	—	●	●	—		—	IC circuit
									—	—	B59W	●	—	●	—	—		—	—

<sup>\*1</sup> Water resistant type auto switches can be mounted on the above models, but in such case SMC cannot guarantee water resistance. Please consult with SMC regarding water resistant types with the above model numbers.

<sup>\*2</sup> 1 m type lead wire is only applicable to D-A93.

• Lead wire length symbols: 0.5 m ..... Nil (Example) M9NV  
1 m ..... M (Example) M9NVV  
3 m ..... L (Example) M9NVL  
5 m ..... Z (Example) M9NVZ  
None ..... N (Example) H7CN

• Solid state auto switches marked with "○" are produced upon receipt of order.

• Since there are other applicable auto switches than listed above, refer to page 446 for details.

• For details about auto switches with pre-wired connector, refer to pages 1340 and 1341.

• The D-A93□□M9□□□ auto switches are shipped together, (but not assembled). (However, only auto switch mounting brackets are assembled before shipment.)



# CG1KR Series

**CG1KR series direct mount, non-rotating rod type cylinder can be installed directly through the use of a square rod cover.**

## Space-saving has been realized.

Because it is a directly mounted type without using brackets, its overall length is shorter, and its installation pitch can be made smaller. Thus, the space that is required for installation has been dramatically reduced.



**Symbol** Rubber bumper

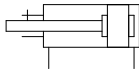

**Made to Order**  
Click here for details

Symbol	Specifications
-XC8	Adjustable stroke cylinder/Adjustable extension type
-XC9	Adjustable stroke cylinder/Adjustable retraction type
-XC20	Head cover axial port

## Accessories

	Mounting	Basic
Standard	Rod end nut	●
Option	Single knuckle joint	●
	Double knuckle joint*1 (with pin)	●

- \*1 A double knuckle joint pin and retaining rings are shipped together.  
\*2 Refer to page 395 for part numbers and dimensions of the accessories.  
\*3 Stainless steel accessories are also available. Refer to page 396 for details.

Refer to pages 440 to 446 for cylinders with auto switches.

- Auto switch proper mounting position (detection at stroke end) and its mounting height
- Minimum stroke for auto switch mounting
- Auto switch mounting brackets/Part no.
- Operating range
- Cylinder mounting bracket, by stroke/ Auto switch mounting surfaces

## ⚠ Precautions

Refer to page 448 before handling.

## Specifications

Bore size (mm)	20	25	32	40	50	63
<b>Action</b>	Double acting, Single rod					
<b>Lubricant</b>	Not required (Non-lube)					
<b>Fluid</b>	Air					
<b>Proof pressure</b>	1.5 MPa					
<b>Maximum operating pressure</b>	1.0 MPa					
<b>Minimum operating pressure</b>	0.05 MPa					
<b>Ambient and fluid temperature</b>	Without auto switch: -10°C to 70°C (No freezing) With auto switch: -10°C to 60°C					
<b>Piston speed</b>	50 to 500 mm/s					
<b>Stroke length tolerance</b>	Up to 300 st <sup>+14</sup> <sub>0</sub> mm					
<b>Cushion</b>	Rubber bumper					
<b>Rod non-rotating accuracy</b>	±1°		±0.8°			±0.5°

## Weights

Bore size (mm)	20	25	32	40	50	63
Basic weight	0.14	0.24	0.35	0.56	1.04	1.48
Single knuckle joint	0.05	0.09	0.09	0.10	0.22	0.22
Double knuckle joint (with pin)	0.05	0.09	0.09	0.13	0.26	0.26
Additional weight per 50 mm of stroke	0.05	0.07	0.09	0.15	0.22	0.26
Weight reduction for female rod end	-0.01	-0.02	-0.02	-0.05	-0.10	-0.10

Calculation (Example) **CG1KRN32-100Z** (ø32, 100 stroke)  
 • Basic weight ..... 0.35  
 • Additional weight ..... 0.09/50 stroke  
 • Air cylinder stroke ..... 100 stroke  
 0.35 + 0.09 × 100/50 = **0.53 kg**

## Standard Strokes

Bore size	Standard stroke* (mm)
<b>20</b>	25, 50, 75, 100, 125, 150
<b>25, 32</b>	25, 50, 75, 100, 125, 150, 200
<b>40, 50, 63</b>	25, 50, 75, 100, 125, 150, 200, 250, 300

- \* Please consult with SMC for strokes which exceed the standard stroke length.  
 Note 1) Intermediate strokes not listed above are produced upon receipt of order. Manufacture of intermediate strokes at 1 mm intervals is possible. (Spacers are not used.)  
 Note 2) Applicable strokes should be confirmed according to the usage. For details, refer to "Air Cylinders Model Selection" on pages 8 to 19. In addition, the products that exceed the standard stroke might not be able to fulfill the specifications due to the deflection etc.

**Tightening Torque:** Tighten the cylinder mounting bolts with the following tightening torque.

Bore size (mm)	Hexagon socket head cap screw size	Tightening torque (N·m)
<b>20</b>	M5 x 0.8	2.4 to 3.6
<b>25</b>	M6	4.2 to 6.2
<b>32</b>	M8	10.0 to 15.0
<b>40</b>	M10	19.6 to 29.4
<b>50</b>	M12	33.6 to 50.4
<b>63</b>	M16	84.8 to 127.2

## Ordering Example of Cylinder Assembly

Cylinder model: **CDG1KRN20-100Z-W-M9BW**

Rod end bracket W: Double knuckle joint  
 Auto switch D-M9BW: 2 pcs.

- \* Double knuckle joint and auto switch are shipped together with the product, but not assembled.

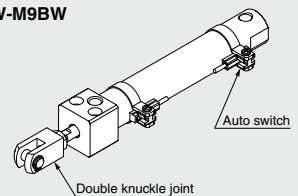



## Construction

### Non-rotating rod type/ Bottom mounting type

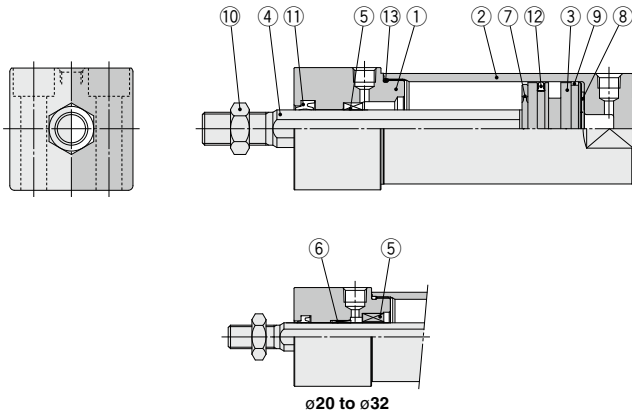

### Component Parts

No.	Description	Material	Note
1	Rod cover	Aluminum alloy	Anodized
2	Tube cover	Aluminum alloy	Hard anodized
3	Piston	Aluminum alloy	
4	Piston rod	ø20 to ø32	Stainless steel
		ø40 to ø63	Carbon steel
5	Non-rotating guide	Oil-impregnated sintered alloy	
6	Bushing	Oil-impregnated sintered alloy	ø20 to ø32 only
7	Bumper	Resin	
8	Bumper	Resin	
9	Wear ring	Resin	
10	Rod end nut	Carbon steel	Zinc chromated
11	Rod seal	NBR	
12	Piston seal	NBR	
13	Tube gasket	NBR	

Replacement parts/Seal kit are the same as double acting, non-rotating rod type. Refer to page 416.

Note) As sizes ø50 and larger cannot be disassembled, the seal cannot be replaced.

Note) Refer to the Specific Product Precautions on page 448 for Disassembly/Replacement.

# CG1KR Series

## Basic with Bottom Mounting: CG1KRN

With rubber bumper

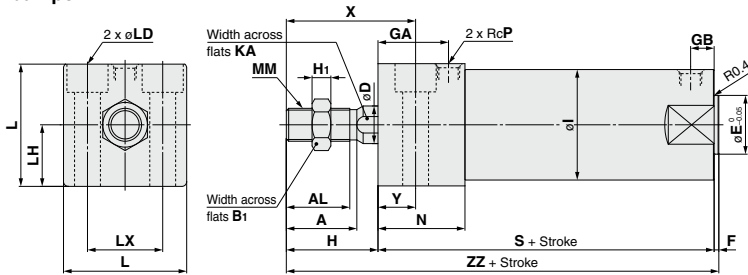

Female rod end

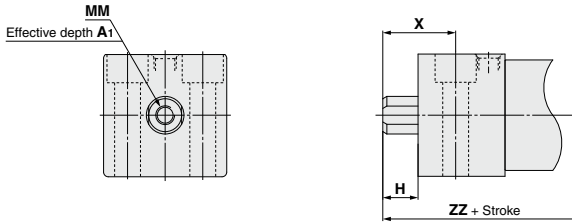

Female Rod End (mm)

Bore size (mm)	A <sub>1</sub>	H	MM	X	ZZ
20	8	13	M4 x 0.7	24	90
25	8	14	M5 x 0.8	26	93
32	12	14	M6 x 1	27	99
40	13	15	M8 x 1.25	31	111
50	18	16	M10 x 1.5	33	126
63	18	16	M10 x 1.5	35	132

Bore size (mm)	Stroke range (mm)	A	AL	B <sub>1</sub>	D	E	F	GA	GB	H	H <sub>1</sub>	I	KA	L	LD	LH	LX	MM	N	P	S	X	Y	ZZ
20	Up to 150	18	15.5	13	9.2	12	2	20	10	27	5	26	8	30.4	ø5.5, ø9.5 depth of counterbore 6	15	18	M8 x 1.25	27	1/8	75	38	11	104
25	Up to 200	22	19.5	17	11	14	2	22	10	32	6	31	10	36.4	ø6.6, ø11 depth of counterbore 7	18	22	M10 x 1.25	29	1/8	77	44	12	111
32	Up to 200	22	19.5	17	12	18	2	26	10	32	6	38	10	42.4	ø9, ø14 depth of counterbore 9	21	24	M10 x 1.25	33	1/8	83	45	13	117
40	Up to 300	30	27	19	16	25	2	30	10	39	8	47	14	52.4	ø11, ø17.5 depth of counterbore 12	26	32	M14 x 1.5	37	1/8	94	55	16	135
50	Up to 300	35	32	27	20	30	2	33	12	45	11	58	18	64.5	ø14, ø20 depth of counterbore 14	32	41	M18 x 1.5	44	1/4	108	62	17	155
63	Up to 300	35	32	27	20	32	2	39	12	45	11	72	18	76.6	ø18, ø26 depth of counterbore 18	38	46	M18 x 1.5	50	1/4	114	64	19	161

Auto switch mounting position is the same as that on page 442.

# Air Cylinder: With End Lock

# CBG1 Series

ø20, ø25, ø32, ø40, ø50, ø63, ø80, ø100

## How to Order

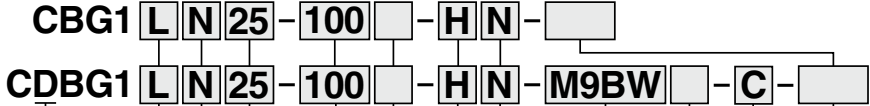

With auto switch  
(Built-in magnet)

**Mounting**

B	Basic
L	Axial foot
F	Rod flange
G	Head flange
U*	Rod trunnion
T*	Head trunnion
D	Clevis

**Type**

N	Rubber bumper
A	Air cushion

**Bore size**

20	20 mm	50	50 mm
25	25 mm	63	63 mm
32	32 mm	80	80 mm
40	40 mm	100	100 mm

**Cylinder stroke (mm)**  
Refer to "Standard Strokes" on page 432.

**Manual release**

N	Non-locking type
L	Locking type

**Lock position**

H	Head end lock
R	Rod end lock
W	Double end lock

**Number of auto switches**

Nil	2 pcs.
S	1 pc.
n	"n" pcs.

**Auto switch**

Nil	Without auto switch
-----	---------------------

\* For applicable auto switches, refer to the table below.

**With rod boot**

Nil	Without rod boot
J	Nylon tarpaulin
K	Heat resistant tarpaulin

\* In the case of w/rod boot, and a foot bracket or rod side flange as a bracket, those parts are to be assembled at the time of shipment.

**Auto switch mounting bracket** (Note)  
Note) This symbol is indicated when the D-A9□ or M9□ type auto switch is specified. This mounting bracket does not apply to other auto switches (D-C7□ and H7□, etc.) (Nil)

**Made to Order**

Refer to page 432 for details.

### Built-in Magnet Cylinder Model

If a built-in magnet cylinder without an auto switch is required, there is no need to enter the symbol for the auto switch. (Example) CDBG1FA32-100-RL

### Applicable Auto Switches/Refer to pages 1271 to 1365 for further information on auto switches.

Type	Special function	Electrical entry	Indicator light	Wiring (Output)	Load voltage		Auto switch model		Lead wire length (m)					Pre-wired connector	Applicable load														
					DC	AC	Applicable bore size		0.5 (Nil)	1 (M)	3 (L)	5 (Z)	None (N)																
							ø20 to ø63	ø80, ø100																					
Solid state auto switch	Diagnostic indication (2-color indicator)	Grommet	Yes	3-wire (NPN)	5 V, 12 V	—	M9NV	M9N	●	●	○	—	○	IC circuit	Relay, PLC														
				3-wire (PNP)					—	—	—	—	—																
				2-wire					—	—	—	—	—																
		Connector	3-wire (NPN)	24 V					5 V, 12 V	—	M9NV	M9N	●			●	○	—	○										
			3-wire (PNP)										—			—	—	—	—										
			2-wire										—			—	—	—	—										
	Grommet	3-wire (NPN)	5 V, 12 V		—	M9NV	M9N	●					●	○		—	○												
		3-wire (PNP)						—					—	—		—	—												
		2-wire						—					—	—		—	—												
	Water resistant (2-color indicator)	Grommet		Yes				3-wire (NPN)	5 V, 12 V	—	M9NAV <sup>*1</sup>	M9NA <sup>*1</sup>	○	○		●	—	○											
								3-wire (PNP)					—	—		—	—	—											
								2-wire					—	—		—	—	—											
Diagnostic output (2-color indicator)	Grommet	Yes	4-wire (NPN)	5 V, 12 V	—	M9NAV <sup>*1</sup>	M9NA <sup>*1</sup>	○					○	●	—	○													
			3-wire (PNP)					—					—	—	—	—													
			2-wire					—					—	—	—	—													
Reed auto switch	Diagnostic indication (2-color indicator)	Grommet	Yes					2-wire	24 V	12 V	A96V	A96	—	—	—	—	—	IC circuit	Relay, PLC										
													Connector	Yes	100 V	A93V <sup>*2</sup>	A93			●	●	●	—	—					
																				Grommet	No	100 V or less	A90V	A90	—	—	—	—	—
		No	200 V or less	—	—	—	●																		●	●	—	—	
							Yes						24 V or less	—											—	—	—	—	—
																				No	—						—	—	—
	Grommet	Yes						—	—	—	—	—						—											
							No					—			—	—	—	—											
																		Yes		—		—	—	—					
	No	—	—	—	—	—																							
						Grommet	Yes						—	—											—	—			
																		No			—						—	—	—
Yes	—							—	—	—	—								—										
						No	—				—	—			—	—	—		—										
																Grommet	Yes	—	—	—		—	—	—					
No		—	—	—	—																		—	—					
						Yes							—	—									—	—	—	—			
																No	—				—				—	—	—	—	—
Grommet	Yes							—	—	—																	—	—	—
						No	—				—	—			—													—	—
																Yes		—	—	—		—						—	—
No	—	—	—	—	—																							—	—

\*1 Water resistant type auto switches can be mounted on the above models, but in such case SMC cannot guarantee water resistance. Please consult with SMC regarding water resistant types with the above model numbers.  
 \*2 1 m type lead wire is only applicable to D-A93.  
 \* Lead wire length symbols: 0.5 m ..... Nil (Example) M9NV 5 m ..... Z (Example) M9NVZ 1 m ..... M (Example) M9NVW 3 m ..... L (Example) M9NVL None ..... N (Example) H7CN \* Solid state auto switches marked with "○" are produced upon receipt of order.

\* Since there are other applicable auto switches than listed above, refer to page 446 for details.  
 \* For details about auto switches with pre-wired connector, refer to pages 1340 and 1341.  
 \* The D-A9□/M9□□ auto switches are shipped together, (but not assembled). (However, only auto switch mounting brackets are assembled before shipment.)

# CBG1 Series



## Symbol

Rubber bumper

Air cushion

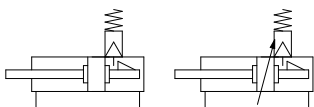

**Made to Order**

[Click here for details](#)

Symbol	Specifications
-XA□	Change of rod end shape
-XC13	Auto switch rail mounting

Refer to pages 440 to 446 for cylinders with auto switches.

- Auto switch proper mounting position (detection at stroke end) and its mounting height
- Minimum stroke for auto switch mounting
- Auto switch mounting brackets/Part no.
- Operating range
- Cylinder mounting bracket, by stroke/ Auto switch mounting surfaces



## Precautions

Refer to page 448 before handling.

## Specifications

Bore size (mm)	20	25	32	40	50	63	80	100
<b>Action</b>	Double acting, Single rod							
<b>Lubricant</b>	Not required (Non-lube)							
<b>Fluid</b>	Air							
<b>Proof pressure</b>	1.5 MPa							
<b>Maximum operating pressure</b>	1.0 MPa							
<b>Minimum operating pressure</b>	0.15 MPa*							
<b>Ambient and fluid temperature</b>	Without auto switch: -10 to 70°C (No freezing) With auto switch: -10 to 60°C (No freezing)							
<b>Piston speed</b>	50 to 1000 mm/s						50 to 700 mm/s	
<b>Stroke length tolerance</b>	Up to 1000 <sup>+14</sup> mm, Up to 1500 <sup>+18</sup> mm							
<b>Cushion</b>	Rubber bumper, Air cushion							
<b>Mounting**</b>	Basic, Axial foot, Rod flange, Head flange, Rod trunnion, Head trunnion, Clevis							

\* 0.05 MPa except locking parts.

\*\* Rod/Head trunnion types are not available for ø80 and ø100.

Trunnion is not attached for a cover on which lock mechanism is equipped.

## Lock Specifications

Lock position	Head end, Rod end, Double end							
<b>Holding force (Max.) (N)</b>	ø20	ø25	ø32	ø40	ø50	ø63	ø80	ø100
	215	330	550	860	1340	2140	3450	5390
<b>Backlash</b>	2 mm or less							
<b>Manual release</b>	Non-locking type, Locking type							

Adjust the switch position so that it operates upon movement to both the stroke end and backlash (2 mm) positions.

## Standard Strokes

Bore size	Standard stroke <sup>Note1)</sup>	Manufacturable stroke (mm)	
		Standard stroke	Manufacturable stroke
20	25, 50, 75, 100, 125, 150, 200	1 to 1500	
25	25, 50, 75, 100, 125, 150, 200, 250, 300		
32			
40			
50, 63			
80			
100			

Note 1) Intermediate strokes not listed above are produced upon receipt of order. Manufacture of intermediate strokes at 1 mm intervals is possible. (Spacers are not used.)

Note 2) Applicable strokes should be confirmed according to the usage. For details, refer to "Air Cylinders Model Selection" on pages 8 to 19. In addition, the products that exceed the standard stroke might not be able to fulfill the specifications due to the deflection etc.

## Rod Boot Material

Symbol	Rod boot material	Maximum operating temperature
J	Nylon tarpaulin	70°C
K	Heat resistant tarpaulin	110°C*

\* Maximum ambient temperature for the rod boot itself.

## Accessories

	Mounting		Basic
	Standard	Rod end nut	
Option		Single knuckle joint	●
		Double knuckle joint*1 (with pin)	●
		Pivot bracket	●

\*1 A double knuckle joint pin and retaining rings are shipped together.

\*2 Refer to page 395 for part numbers and dimensions of the accessories.

\*3 Stainless steel mounting brackets and accessories are also available. Refer to page 396 for details.

## Construction: With Rubber Bumper

### Head end lock

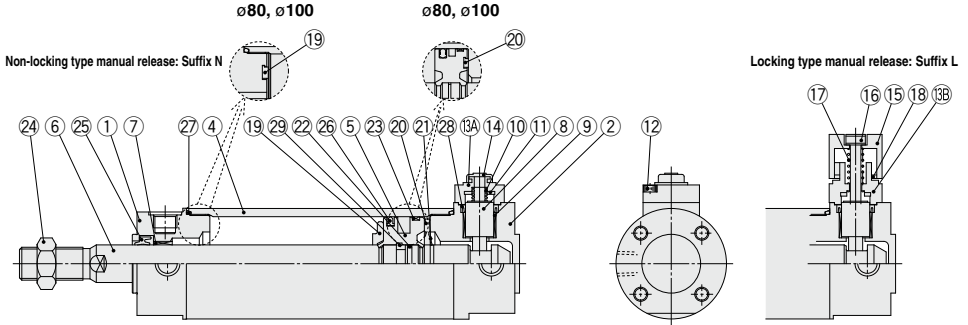

### Rod end lock

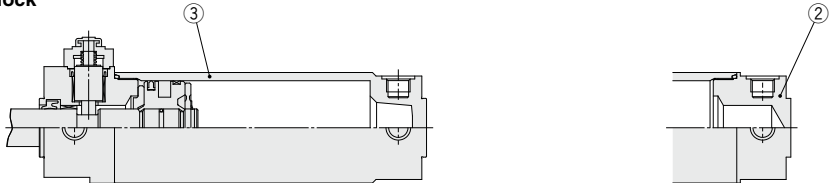

Long stroke

### Component Parts

No.	Description	Material	Note
1	Rod cover	Aluminum alloy	Anodized
2	Head cover	Aluminum alloy	Anodized
3	Tube cover	Aluminum alloy	Hard anodized
4	Cylinder tube	Aluminum alloy	Hard anodized
5	Piston	Aluminum alloy	
6	Piston rod	Carbon steel*	Hard chrome plating*
7	Bushing	Bearing alloy	
8	Lock piston	Carbon steel	Hard chrome plating, Heat treated
9	Lock bushing	Bearing alloy	
10	Lock spring	Stainless steel	
11	Bumper	Resin	
12	Hexagon socket head cap screw	Alloy steel	Black zinc chromated
13A	Cap A	Aluminum die-casted	Black painted
13B	Cap B	Carbon steel	Oxide film treated
14	Rubber cap	Synthetic rubber	

Note) For cylinders with auto switches, the magnet is installed in the piston.

\* The material for  $\phi 20$ ,  $\phi 25$  cylinders with auto switches is made of stainless steel.

### Replacement Parts: Seal Kit (With one end lock)

Series	Bore size (mm)	Kit no.	Contents
CBG1□N Rubber bumper type	20	CBG1N20-PS	Set of the nos. 25, 26, 27, 28 and grease pack
	25	CBG1N25-PS	
	32	CBG1N32-PS	
	40	CBG1N40-PS	

Note) As sizes  $\phi 50$  and larger cannot be disassembled, the seal cannot be replaced.

\* The seal kit includes a grease pack (10 g). Order with the following part number when only the grease pack is needed.  
**Grease pack part number: GR-S-010** (10 g)

No.	Description	Material	Note
15	M/O knob	Zinc die-casted	Black painted
16	M/O bolt	Alloy steel	Black zinc chromated, Red painted
17	M/O spring	Steel wire	Zinc chromated
18	Stopper ring	Carbon steel	Zinc chromated
19	Bumper A	Resin	
20	Bumper B	Resin	$\phi 40$ or larger: Same as bumper A
21	Retaining ring	Stainless steel	Not available for $\phi 80$ , $\phi 100$
22	Piston gasket	NBR	
23	Wear ring	Resin	
24	Rod end nut	Carbon steel	Zinc chromated
25	Rod seal	NBR	
26	Piston seal	NBR	
27	Cylinder tube gasket	NBR	1 pc. when using tube cover
28	Lock piston seal	NBR	2 pcs. for double end lock
29	Piston holder	Resin	$\phi 40$ to $\phi 100$ , head end lock only

### Replacement Parts: Seal Kit (With double end lock)

Series	Bore size (mm)	Kit no.	Contents
CBG1□N Rubber bumper type	20	CBG1N20-PS-W	Set of the nos. 25, 26, 27, 28 and grease pack
	25	CBG1N25-PS-W	
	32	CBG1N32-PS-W	
	40	CBG1N40-PS-W	

Note) As sizes  $\phi 50$  and larger cannot be disassembled, the seal cannot be replaced.

\* The seal kit includes a grease pack (10 g). Order with the following part number when only the grease pack is needed.  
**Grease pack part number: GR-S-010** (10 g)

# CBG1 Series

## Construction: With Air Cushion

### With air cushion Head end lock

Non-locking type manual release: Suffix N

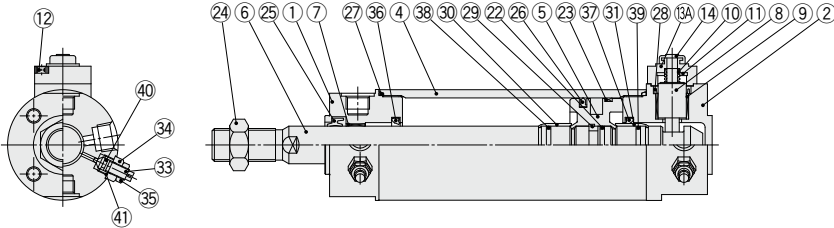

### Rod end lock

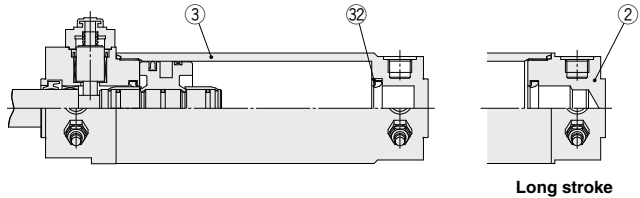

### Component Parts

No.	Description	Material	Note
1	Rod cover	Aluminum alloy	Anodized
2	Head cover	Aluminum alloy	Anodized
3	Tube cover	Aluminum alloy	Hard anodized
4	Cylinder tube	Aluminum alloy	Hard anodized
5	Piston	Aluminum alloy	
6	Piston rod	Carbon steel*	Hard chrome plating*
7	Bushing	Bearing alloy	
8	Lock piston	Carbon steel	Hard chrome plating, Heat treated
9	Lock bushing	Bearing alloy	
10	Lock spring	Stainless steel	
11	Bumper	Resin	
12	Hexagon socket head cap screw	Alloy steel	Black zinc chromated
13A	Cap A	Aluminum die-casted	Black painted
13B	Cap B	Carbon steel	Oxide film treated
14	Rubber cap	Synthetic rubber	
15	M/O knob	Zinc die-casted	Black painted
16	M/O bolt	Alloy steel	Black zinc chromated, Red painted
17	M/O spring	Steel wire	Zinc chromated
18	Stopper ring	Carbon steel	Zinc chromated

Note) For cylinders with auto switches, the magnet is installed in the piston.  
\* The material for ø20, ø25 cylinders with auto switches is made of stainless steel.

### Replacement Parts: Seal Kit (With one end lock)

Series	Bore size (mm)	Kit no.	Contents
CBG1□A Air cushion type	20	CBG1A20-PS	Set of the nos. 25, 26, 27, 28, 40, 41 and grease pack
	25	CBG1A25-PS	
	32	CBG1A32-PS	
	40	CBG1A40-PS	

Note) As sizes ø50 and larger cannot be disassembled, the seal cannot be replaced.

\* The seal kit includes a grease pack (10 g). Order with the following part number when only the grease pack is needed.  
**Grease pack part number: GR-S-010** (10 g)

No.	Description	Material	Note
22	Piston gasket	NBR	
23	Wear ring	Resin	
24	Rod end nut	Carbon steel	Zinc chromated
25	Rod seal	NBR	
26	Piston seal	NBR	
27	Cylinder tube gasket	NBR	1 pc. when using tube cover
28	Lock piston seal	NBR	2 pcs. for double end lock
29	Piston holder	Resin	ø40 to ø100 only
30	Cushion ring A	Aluminum alloy	Anodized
31	Cushion ring B	Aluminum alloy	Anodized
32	Seal retainer	Rolled steel	Only when using nickel plating, tube cover
33	Cushion valve	Rolled steel	Electroless nickel plating
34	Valve retainer	Rolled steel	Electroless nickel plating
35	Lock nut	Rolled steel	Nickel plating
36	Cushion seal A	Urethane	
37	Cushion seal B	Urethane	ø32 or larger: Same as A
38	Cushion ring gasket A	NBR	
39	Cushion ring gasket B	NBR	ø32 or larger: Same as A
40	Valve seal	NBR	
41	Valve retaining gasket	NBR	

### Replacement Parts: Seal Kit (With double end lock)

Series	Bore size (mm)	Kit no.	Contents
CBG1□A Air cushion type	20	CBG1A20-PS-W	Set of the nos. 25, 26, 27, 28, 40, 41 and grease pack
	25	CBG1A25-PS-W	
	32	CBG1A32-PS-W	
	40	CBG1A40-PS-W	

Note) As sizes ø50 and larger cannot be disassembled, the seal cannot be replaced.

\* The seal kit includes a grease pack (10 g). Order with the following part number when only the grease pack is needed.  
**Grease pack part number: GR-S-010** (10 g)

**Basic with Rubber Bumper: CBG1BN**

Head end lock: CBG1BN  —  — H

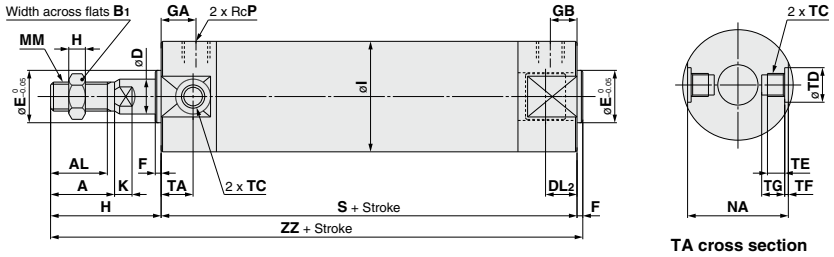

Non-locking type manual release: Suffix N

Locking type manual release: Suffix L

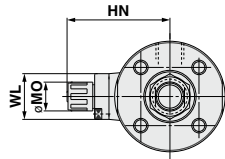
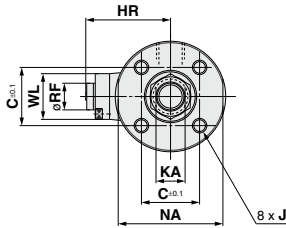

Bore size (mm)	Stroke range	A	AL	B <sub>1</sub>	C	D	DL <sub>2</sub>	E	F	GA	GB	H	H <sub>1</sub>	HR	HN (Max.)	I	J
20	Up to 350	18	15.5	13	14	8	12.5	12	2	12	12	35	5	25.3	37	26	M4 x 0.7 depth 7
25	Up to 400	22	19.5	17	16.5	10	12.5	14	2	12	12	40	6	28.3	40	31	M5 x 0.8 depth 7.5
32	Up to 450	22	19.5	17	20	12	12	18	2	12	12	40	6	31.3	43	38	M5 x 0.8 depth 8
40	Up to 800	30	27	19	26	16	15	25	2	13	13	50	8	38.3	52.5	47	M6 x 1 depth 12
50	Up to 1200	35	32	27	32	20	16.5	30	2	14	14	58	11	44.5	58.5	58	M8 x 1.25 depth 16
63	Up to 1200	35	32	27	38	20	16.5	32	2	14	14	58	11	45	59	72	M10 x 1.5 depth 16
80	Up to 1400	40	37	32	50	25	19	40	3	20	20	71	13	53.5	68	89	M10 x 1.5 depth 22
100	Up to 1500	40	37	41	60	30	20	50	3	20	20	71	16	64.5	79	110	M12 x 1.75 depth 22

Bore size (mm)	K	KA	MM	MO	NA	P	RF	S	TA	TC	TD	TE	TF	TG	WL	ZZ
20	5	6	M8 x 1.25	15	24	1/8	11	81	11	M5 x 0.8	8 <sup>+0.08</sup> <sub>0</sub>	4	0.5	5.5	15	118
25	5.5	8	M10 x 1.25	15	29	1/8	11	81	11	M6 x 0.75	10 <sup>+0.08</sup> <sub>0</sub>	5	1	6.5	15	123
32	5.5	10	M10 x 1.25	15	35.5	1/8	11	81	11	M8 x 1.0	12 <sup>+0.08</sup> <sub>0</sub>	5.5	1	7.5	24	123
40	6	14	M14 x 1.5	19	44	1/8	11	92	12	M10 x 1.25	14 <sup>+0.08</sup> <sub>0</sub>	6	1.25	8.5	24	144
50	7	18	M18 x 1.5	19	55	1/4	11	107	13	M12 x 1.25	16 <sup>+0.08</sup> <sub>0</sub>	7.5	2	10	24	167
63	7	18	M18 x 1.5	19	69	1/4	11	107	13	M14 x 1.5	18 <sup>+0.08</sup> <sub>0</sub>	11.5	3	14.5	24	167
80	10	22	M22 x 1.5	23	80	3/8	21	130	—	—	—	—	—	—	40	204
100	10	26	M26 x 1.5	23	100	1/2	21	130	—	—	—	—	—	—	40	204

# CBG1 Series

## Basic with Rubber Bumper: CBG1BN

Rod end lock: CBG1BN  —  — R

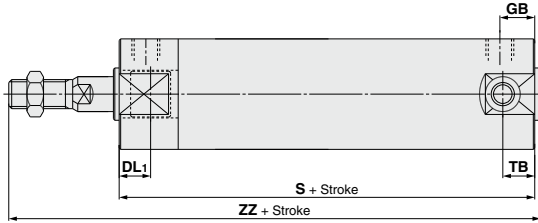

Bore size (mm)	(mm)				
	DL1	GB	S	TB	ZZ
20	19.5	10 (12)	80 (88)	11	117 (125)
25	19.5	10 (12)	80 (88)	11	122 (130)
32	20	10 (12)	81 (89)	10 (11)	123 (131)
40	19	10 (13)	87 (96)	10 (12)	139 (148)
50	23.5	12 (14)	102 (114)	12 (13)	162 (174)
63	23.5	12 (14)	102 (114)	12 (13)	162 (174)
80	27	16 (20)	124 (138)	—	198 (212)
100	30	16 (20)	124 (138)	—	198 (212)

\* ( ): Denotes the dimensions for long stroke.

Double end lock: CBG1BN  —  — W

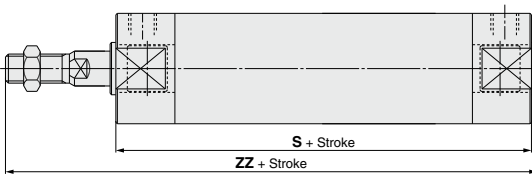

Bore size (mm)	(mm)	
	S	ZZ
20	92	129
25	92	134
32	91	133
40	101	153
50	119	179
63	119	179
80	146	220
100	146	220

## With rod boot

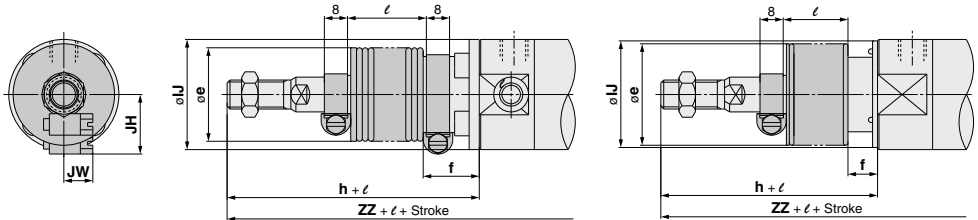

ø20 to ø63

ø80, ø100

Bore size (mm)	e	f	h	J	JH (Reference)	JW (Reference)	l	(mm)		
								Head end lock: -H <input type="text"/>	Rod end lock: -R <input type="text"/>	Double end lock: -W <input type="text"/>
								ZZ	ZZ	ZZ
20	30	18	55	27	15.5	10.5	1/4 stroke	138	137 (145)	149
25	30	19	62	32	16.5	10.5		145	144 (152)	156
32	35	19	62	38	18.5	10.5		145	145 (153)	155
40	35	19	70	48	21.5	10.5		164	159 (168)	173
50	40	19	78	59	24	10.5		187	182 (194)	199
63	40	20	78	72	24	10.5		187	182 (194)	199
80	52	10	80	59	—	—		213	207 (221)	229
100	62	7	80	71	—	—		213	207 (221)	229

\* ( ): Denotes the dimensions for long strokes.  
 \*\* The minimum stroke with rod boot is 20 mm.



**Basic with Air Cushion: CBG1BA**

Head end lock: CBG1BA  Bore size  — Stroke  — H

Rod end lock: CBG1BA  Bore size  — Stroke  — R

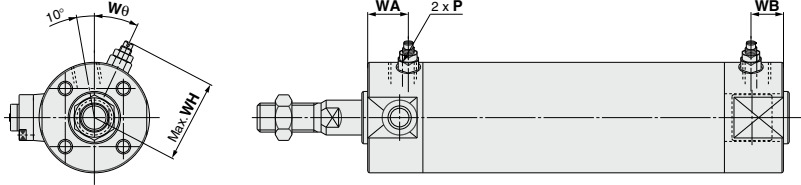

**Head End Lock: -H**

(mm)

Bore size (mm)	P	WA	WB	WH	Wθ
20	M5 x 0.8	16	16	23	30°
25	M5 x 0.8	16	16	25	30°
32	Rc1/8	16	16	28.5	25°
40	Rc1/8	16	16	33	20°
50	Rc1/4	18	18	40.5	20°
63	Rc1/4	18	18	47.5	20°
80	Rc3/8	22	22	60.5	20°
100	Rc1/2	22	22	71	20°

\* For dimensions other than listed above, refer to the dimensions with rubber bumper.

**Rod End Lock: -R**

(mm)

Bore size (mm)	P	WA	WB	WH	Wθ
20	M5 x 0.8	16	15 (16)	23	30°
25	M5 x 0.8	16	15 (16)	25	30°
32	Rc1/8	16	15 (16)	28.5	25°
40	Rc1/8	16	15 (16)	33	20°
50	Rc1/4	18	17 (18)	40.5	20°
63	Rc1/4	18	17 (18)	47.5	20°
80	Rc3/8	22	22	60.5	20°
100	Rc1/2	22	22	71	20°

\* ( ): Denotes the dimensions for long strokes.

\*\* For dimensions other than the listed above, refer to the dimensions with rubber bumper.

Double end lock: CBG1BA  Bore size  — Stroke  — W

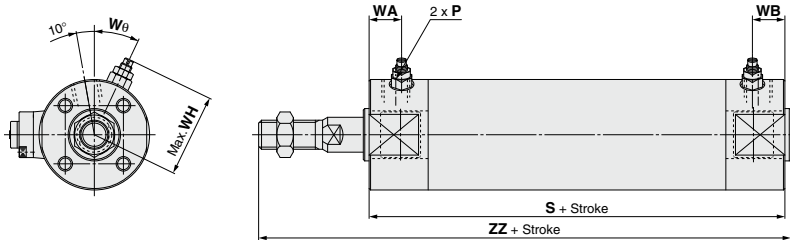

(mm)

Bore size (mm)	P	S	WA	WB	WH	Wθ	ZZ
20	M5 x 0.8	92	16	16	23	30°	129
25	M5 x 0.8	92	16	16	25	30°	134
32	Rc1/8	91	16	16	28.5	25°	133
40	Rc1/8	101	16	16	33	20°	153
50	Rc1/4	119	18	18	40.5	20°	179
63	Rc1/4	119	18	18	47.5	20°	179
80	Rc3/8	146	22	22	60.5	20°	220
100	Rc1/2	146	22	22	71	20°	220

\* For dimensions other than listed above, refer to the dimensions with rubber bumper.

# CBG1 Series

## With Mounting Bracket

(For dimensions other than listed below, refer to pages 435 to 437, 387 to 389.)

### Axial foot: CBG1L□

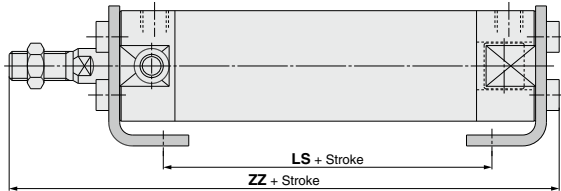

(mm)

Bore size (mm)	Head end lock: -H□			Rod end lock: -R□			Double end lock: -W□		
	LS	ZZ		LS	ZZ		LS	ZZ	
		Without rod boot	With rod boot		Without rod boot	With rod boot		Without rod boot	With rod boot
20	57	122	142 + ℓ	56 (64)	121 (129)	141 (149) + ℓ	68	133	153 + ℓ
25	57	127.5	149.5 + ℓ	56 (64)	126.5 (134.5)	148.5 (156.5) + ℓ	68	138.5	160.5 + ℓ
32	55	127.5	149.5 + ℓ	55 (63)	127.5 (135.5)	149.5 (157.5) + ℓ	65	137.5	159.5 + ℓ
40	65	149	169 + ℓ	60 (69)	144 (153)	164 (173) + ℓ	74	158	178 + ℓ
50	72	174.5	194.5 + ℓ	67 (79)	169.5 (181.5)	189.5 (201.5) + ℓ	84	186.5	206.5 + ℓ
63	72	174.5	194.5 + ℓ	67 (79)	169.5 (181.5)	189.5 (201.5) + ℓ	84	186.5	206.5 + ℓ
80	82	210.5	219.5 + ℓ	76 (90)	204.5 (218.5)	213.5 (227.5) + ℓ	98	226.5	235.5 + ℓ
100	82	214	223 + ℓ	76 (90)	208 (222)	217 (231) + ℓ	98	230	239 + ℓ

\* (ℓ): Denotes the dimensions for long stroke.

### Rod flange: CBG1F□

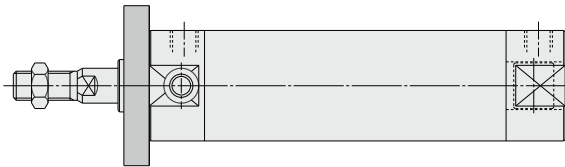

### Head flange: CBG1G□

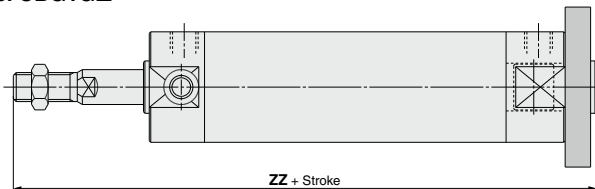

(mm)

Bore size (mm)	Head end lock: -H□		Rod end lock: -R□		Double end lock: -W□	
	ZZ (Head flange)					
	Without rod boot	With rod boot	Without rod boot	With rod boot	Without rod boot	With rod boot
20	124	144 + ℓ	123 (131)	143 (151) + ℓ	135	155 + ℓ
25	130	152 + ℓ	129 (137)	151 (159) + ℓ	141	163 + ℓ
32	130	152 + ℓ	130 (138)	152 (160) + ℓ	140	162 + ℓ
40	152	172 + ℓ	147 (156)	167 (176) + ℓ	161	181 + ℓ
50	176	196 + ℓ	171 (183)	191 (203) + ℓ	188	208 + ℓ
63	176	196 + ℓ	171 (183)	191 (203) + ℓ	188	208 + ℓ
80	215	224 + ℓ	209 (223)	218 (232) + ℓ	231	240 + ℓ
100	218	227 + ℓ	212 (226)	221 (235) + ℓ	234	243 + ℓ

\* (ℓ): Denotes the dimensions for long stroke.

**With Mounting Bracket**

**Rod trunnion: CBG1U□**  
(Head end lock -H□ only)

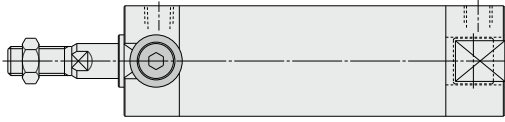

**Head trunnion: CBG1T□**  
(Rod end lock -R□ only)

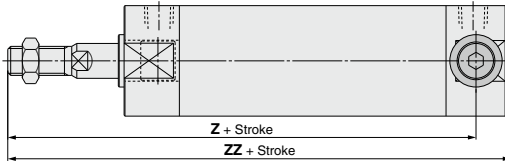

Bore size (mm)	Rod end lock: -R□			
	Z (Head trunnion)		ZZ (Head trunnion)	
	Without rod boot	With rod boot	Without rod boot	With rod boot
20	104 (112)	124 (132) + ℓ	117 (125)	137 (145) + ℓ
25	109 (117)	131 (139) + ℓ	122 (130)	144 (152) + ℓ
32	111 (119)	133 (141) + ℓ	123 (131)	145 (153) + ℓ
40	127 (134)	147 (154) + ℓ	139 (148)	159 (168) + ℓ
50	148 (159)	168 (179) + ℓ	162 (174)	182 (194) + ℓ
63	148 (159)	168 (179) + ℓ	162 (174)	182 (194) + ℓ

\* ( ℓ ): Denotes the dimensions for long stroke.

**Clevis: CBG1D□**  
ø20 to ø63

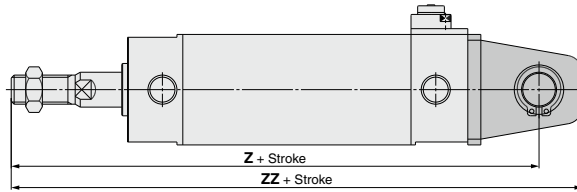

**Clevis: CBG1D□**  
ø80, ø100

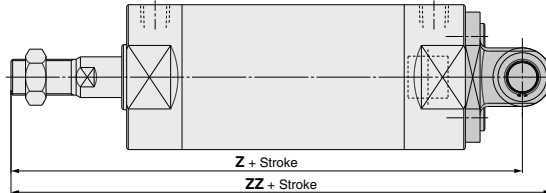

Bore size (mm)	Head end lock: -H□				Rod end lock: -R□			
	Z		ZZ		Z		ZZ	
	Without rod boot	With rod boot	Without rod boot	With rod boot	Without rod boot	With rod boot	Without rod boot	With rod boot
20	130	150 + ℓ	141	161 + ℓ	129 (137)	149 (157) + ℓ	140 (148)	160 (168) + ℓ
25	137	159 + ℓ	150	172 + ℓ	136 (144)	158 (166) + ℓ	149 (157)	171 (179) + ℓ
32	141	163 + ℓ	156	178 + ℓ	141 (149)	163 (171) + ℓ	156 (164)	178 (186) + ℓ
40	164	184 + ℓ	182	202 + ℓ	159 (168)	179 (188) + ℓ	177 (186)	197 (206) + ℓ
50	190	210 + ℓ	210	230 + ℓ	185 (197)	205 (217) + ℓ	205 (217)	225 (237) + ℓ
63	195	215 + ℓ	217	237 + ℓ	190 (202)	210 (222) + ℓ	212 (224)	232 (244) + ℓ
80	236	245 + ℓ	254	263 + ℓ	230 (244)	239 (253) + ℓ	248 (262)	257 (277) + ℓ
100	244	253 + ℓ	266	275 + ℓ	238 (252)	247 (261) + ℓ	260 (274)	269 (283) + ℓ

Bore size (mm)	Double end lock: -W□			
	Z		ZZ	
	Without rod boot	With rod boot	Without rod boot	With rod boot
20	141	161 + ℓ	152	172 + ℓ
25	148	170 + ℓ	161	183 + ℓ
32	151	173 + ℓ	166	188 + ℓ
40	173	193 + ℓ	191	211 + ℓ
50	202	222 + ℓ	222	242 + ℓ
63	207	227 + ℓ	229	249 + ℓ
80	252	261 + ℓ	270	279 + ℓ
100	260	269 + ℓ	282	291 + ℓ

\* ( ℓ ): Denotes the dimensions for long stroke.

# CG1 Series Auto Switch Mounting

## Auto Switch Proper Mounting Position (Detection at Stroke End) and Its Mounting Height

### Solid state auto switch

D-M9□/M9□W, D-M9□A

ø20 to ø63

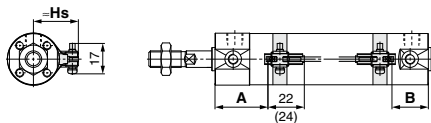

( ): Dimension of the D-M9□A  
A and B are the dimensions from the end of the head cover/rod cover to the end of the auto switch.

D-M9□V/M9□WV, D-M9□AV

ø20 to ø63

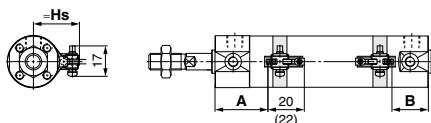

( ): Dimension of the D-M9□AV  
A and B are the dimensions from the end of the head cover/rod cover to the end of the auto switch.

D-G5/K5/G5□W/G5BA

D-K59W, D-G59F, D-G5NT

ø20 to ø100

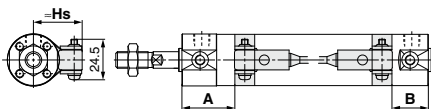

D-H7□/H7□W

D-H7NF/H7BA/D-H7C

ø20 to ø63

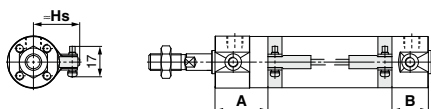

### Reed auto switch

D-A9□

ø20 to ø63

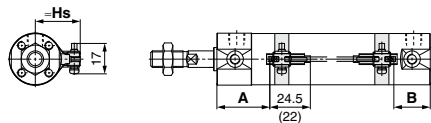

( ): Dimension of the D-A9□  
A and B are the dimensions from the end of the head cover/rod cover to the end of the auto switch.

D-A9□V

ø20 to ø63

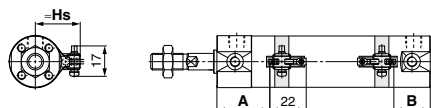

A and B are the dimensions from the end of the head cover/rod cover to the end of the auto switch.

D-C7/C8, D-C73C/C80C

ø20 to ø63

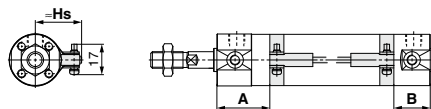

D-B5/B6/B59W

ø20 to ø100

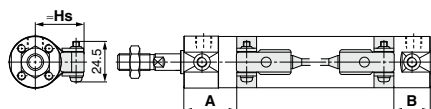

### Auto Switch Mounting Height

(mm)

Auto switch model	D-M9□(V)	D-H7□	D-C73C D-C80C	D-G5/K5	D-G5NT
	D-M9□W(V)	D-H7□W		D-G5□W	D-G59F
Bore size	D-M9□A(V)	D-H7NF	D-C73C D-C80C	D-K59W	D-H7C
	D-A9□(V)	D-H7BA		D-B5/B6	D-G5BA
	Hs	Hs		Hs	
20	26.5	27		27.5	
25	29	29.5		30	
32	32.5	33		33.5	
40	37	37.5		38	
50	42.5	43		43.5	
63	49.5	50		50.5	
80	—	—		59	
100	—	—		69.5	

**Auto Switch Proper Mounting Position (Detection at Stroke End)**

**Except Single Acting, Direct Mount Type (CG1R, CG1KR) and With End Lock (CBG1)**

(mm)

Auto switch model	D-M9□ D-M9□V D-M9□W D-M9□WV D-M9□A D-M9□AV		D-A9□ D-A9□V		D-H7□W D-H7NF D-H7BA D-H7□ D-H7C		D-C7□ D-C80 D-C73C D-C80C		D-G5□/K59 D-G5□W/K59W D-G59F D-G5NT D-G5BA		D-B5□ D-B64		D-B59W	
	A	B	A	B	A	B	A	B	A	B	A	B	A	B
<b>20</b>	33	24 (32)	29	20 (28)	28.5	19.5 (27.5)	29.5	20.5 (28.5)	25	16 (24)	23.5	14.5 (22.5)	26.5	17.5 (25.5)
<b>25</b>	32.5	24.5 (32.5)	28.5	20.5 (28.5)	28	20 (28)	29	21 (29)	24.5	16.5 (24.5)	23	15 (23)	26	18 (26)
<b>32</b>	34	25 (33)	30	21 (29)	29.5	20.5 (28.5)	30.5	21.5 (29.5)	26	17 (25)	24.5	15.5 (23.5)	27.5	18.5 (26.5)
<b>40</b>	39	27 (36)	35	23 (32)	34.5	22.5 (31.5)	35.5	23.5 (32.5)	31	19 (28)	29.5	17.5 (26.5)	32.5	20.5 (29.5)
<b>50</b>	46	32 (44)	42	28 (40)	41.5	27.5 (39.5)	42.5	28.5 (40.5)	38	24 (36)	36.5	22.5 (34.5)	39.5	25.5 (37.5)
<b>63</b>	44.5	33.5 (45.5)	40.5	29.5 (41.5)	40	29 (41)	41	30 (42)	36.5	25.5 (37.5)	35	24 (36)	38	27 (39)
<b>80</b>	—	—	—	—	—	—	—	—	49.5	30.5 (44.5)	48	29 (43)	51	32 (46)
<b>100</b>	—	—	—	—	—	—	—	—	48.5	31.5 (45.5)	47	30 (44)	50	33 (47)

Note 1) The values in ( ) are for long stroke.

Note 2) Adjust the auto switch after confirming the operating condition in the actual setting.

**Single Acting, Spring Return Type (S)**

Auto switch model	Bore size	A dimensions				B
		Up to 50 st	51 to 100 st	101 to 125 st	126 to 200 st	
D-M9□(V) D-M9□W(V) D-M9□A(V)	20	58	83	108	—	24
	25	57.5	82.5	107.5	132.5	24.5
	32	59	84	109	134	25
	40	64	89	114	139	27
D-A9□(V)	20	54	79	104	—	20
	25	53.5	78.5	103.5	128.5	20.5
	32	55	80	105	130	21
	40	60	85	110	135	23
D-H7□ D-H7□W D-H7C D-H7BA D-H7NF	20	53.5	78.5	103.5	—	19.5
	25	53	78	103	128	20
	32	54.5	79.5	109.5	129.5	20.5
	40	59.5	84.5	109.5	134.5	22.5
D-C7□ D-C80 D-C73C D-C80C	20	54.5	79.5	104.5	—	20.5
	25	54	79	104	129	21
	32	55.5	80.5	105.5	130.5	21.5
	40	60.5	85.5	110.5	135.5	23.5
D-G5NT D-G59F	20	50	75	100	—	16
	25	49.5	74.5	99.5	124.5	16.5
	32	51	76	101	126	17
	40	56	81	106	131	19
D-B5□ D-B64	20	48.5	73.5	98.5	—	14.5
	25	48	73	98	123	15
	32	49.5	74.5	99.5	124.5	15.5
	40	54.5	79.5	104.5	129.5	17.5
D-B59W	20	51.5	76.5	101.5	—	17.5
	25	51	76	101	126	18
	32	52.5	77.5	102.5	127.5	18.5
	40	57.5	82.5	107.5	132.5	20.5

Note) Adjust the auto switch after confirming the operating condition in the actual setting.

# CG1 Series

## Auto Switch Proper Mounting Position (Detection at Stroke End)

### Single Acting, Spring Extend Type (T)

(mm)

Auto switch model	Bore size	A	B dimensions			
			Up to 50 st	51 to 100 st	101 to 125 st	126 to 200 st
D-M9□(V) D-M9□W(V) D-M9□A(V)	20	33	49	74	99	—
	25	32.5	49.5	74.5	99.5	124.5
	32	34	50	75	100	125
D-A9□(V)	40	39	52	77	102	127
	20	29	45	70	95	—
	25	28.5	45.5	70.5	95.5	120.5
	32	30	46	71	96	121
D-H7□ D-H7□W D-H7C D-H7BA D-H7NF	40	35	48	73	98	123
	20	28.5	44.5	69.5	94.5	—
	25	28	45	70	95	120
	32	29.5	45.5	70.5	95.5	120.5
D-C7□ D-C80 D-C73C D-C80C	40	34.5	47.5	72.5	97.5	122.5
	20	29.5	45.5	70.5	95.5	—
	25	29	46	71	96	121
	32	30.5	46.5	71.5	96.5	121.5
D-G5NT D-G59F	40	35.5	48.5	73.5	98.5	123.5
	20	25	41	66	91	—
	25	24.5	41.5	66.5	91.5	116.5
	32	26	42	67	92	117
D-B5□ D-B64	40	31	44	69	94	119
	20	23.5	39.5	64.5	89.5	—
	25	23	40	65	90	115
	32	24.5	40.5	65.5	90.5	115.5
D-B59W	40	29.5	42.5	67.5	92.5	117.5
	20	26.5	42.5	67.5	92.5	—
	25	26	43	68	93	118
	32	27.5	43.5	68.5	93.5	118.5
	40	32.5	45.5	70.5	95.5	120.5

Note) Adjust the auto switch after confirming the operating condition in the actual setting.

### Direct Mount Type (CG1R, CG1KR)

(mm)

Auto switch model	D-M9□ D-M9□V D-M9□W D-M9□WV D-M9□A D-M9□AV		D-A9□ D-A9□V		D-H7□W D-H7NF D-H7BA D-H7□ D-H7C		D-C7□ D-C80 D-C73C D-C80C		D-G59F D-G5NT		D-B5□ D-B64		D-B59W	
	A	B	A	B	A	B	A	B	A	B	A	B	A	B
Bore size														
20	12	24	8	20	7.5	19.5	8.5	20.5	4	16	2.5	14.5	5.5	17.5
25	11.5	24.5	7.5	20.5	7	20	8	21	3.5	16.5	2	15	5	18
32	13	25	9	21	8.5	20.5	9.5	21.5	5	17	3.5	15.5	6.5	18.5
40	18	27	14	23	13.5	22.5	14.5	23.5	10	19	8.5	17.5	11.5	20.5
50	20	32	16	28	15.5	27.5	16.5	28.5	12	24	10.5	22.5	13.5	25.5
63	18.5	33.5	14.5	29.5	14	29	15	30	10.5	25.5	9	24	12	27

Note) Adjust the auto switch after confirming the operating condition in the actual setting.

**Auto Switch Proper Mounting Position (Detection at Stroke End)**

**With End Lock (CBG1)**

(mm)

Auto switch model	Lock position	D-M9□ D-M9□V D-M9□W D-M9□WV D-M9□A D-M9□AV		D-A9□ D-A9□V		D-H7□ D-H7C D-H7□W D-H7BA D-H7NF		D-G5□W D-K59W D-G59F D-G5 D-K5 D-G5NT D-G5BA		D-C7 D-C8 D-C73C D-C80C		D-B5 D-B6		D-B59W	
		A	B	A	B	A	B	A	B	A	B	A	B	A	B
20	Head end	33	36	29	32	28.5	31.5	25	28	29.5	32.5	23.5	26.5	26.5	29.5
	Rod end	44	24 (32)	40	20 (28)	39.5	19.5 (27.5)	36	16 (24)	40.5	20.5 (28.5)	34.5	14.5 (22.5)	37.5	17.5 (25.5)
	Double end	44	36	40	32	39.5	31.5	36	28	40.5	32.5	34.5	26.5	37.5	29.5
25	Head end	33	36	29	32	28.5	31.5	25	28	29.5	32.5	23.5	26.5	26.5	29.5
	Rod end	44	24 (32)	40	20 (28)	39.5	19.5 (27.5)	36	16 (24)	40.5	20.5 (28.5)	34.5	14.5 (22.5)	37.5	17.5 (25.5)
	Double end	44	36	40	32	39.5	31.5	36	28	40.5	32.5	34.5	26.5	37.5	29.5
32	Head end	34	35	30	31	29.5	30.5	26	27	30.5	31.5	24.5	25.5	27.5	28.5
	Rod end	44	25 (33)	40	21 (29)	39.5	20.5 (28.5)	36	17 (25)	40.5	21.5 (29.5)	34.5	15.5 (23.5)	37.5	18.5 (26.5)
	Double end	44	35	40	31	39.5	30.5	36	27	40.5	31.5	34.5	25.5	37.5	28.5
40	Head end	39	41	35	37	34.5	36.5	31	33	35.5	37.5	29.5	31.5	32	34.5
	Rod end	48	27 (36)	44	23 (32)	43.5	22.5 (31.5)	40	19 (28)	44.5	23.5 (32.5)	38.5	17.5 (26.5)	41	20.5 (29.5)
	Double end	48	41	44	37	43.5	36.5	40	33	44.5	37.5	38.5	31.5	41	34.5
50	Head end	46	49	42	45	41.5	44.5	38	41	42.5	45.5	36.5	39.5	39.5	42.5
	Rod end	58	32 (44)	54	28 (40)	53.5	27.5 (39.5)	50	24 (36)	54.5	28.5 (40.5)	48.5	22.5 (34.5)	51.5	25.5 (37.5)
	Double end	58	49	54	45	53.5	44.5	50	41	54.5	45.5	48.5	39.5	51.5	42.5
63	Head end	46	49	42	45	41.5	44.5	38	41	42.5	45.5	36.5	39.5	39.5	42.5
	Rod end	58	32 (44)	54	28 (40)	53.5	27.5 (39.5)	50	24 (36)	54.5	28.5 (40.5)	48.5	22.5 (34.5)	51.5	25.5 (37.5)
	Double end	58	49	54	45	53.5	44.5	50	41	54.5	45.5	48.5	39.5	51.5	42.5
80	Head end							48	54			46.5	52.5	49.5	55.5
	Rod end	—	—	—	—	—	—	64	32 (46)	—	—	62.5	30.5 (44.5)	65.5	33.5 (47.5)
	Double end							64	54			62.5	52.5	65.5	55.5
100	Head end							48	54			46.5	52.5	49.5	55.5
	Rod end	—	—	—	—	—	—	64	32 (46)	—	—	62.5	30.5 (44.5)	65.5	33.5 (47.5)
	Double end							64	54			62.5	52.5	65.5	55.5

Note 1) The values in ( ) are for long stroke.

Note 2) Adjust the auto switch after confirming the operating condition in the actual setting.

## Minimum Stroke for Auto Switch Mounting

Auto switch model	n: Number of auto switches (mm)					
	With 1 pc.	Number of auto switches			With n pcs.	
		Different surfaces	Same surface	Different surfaces	Same surface	
D-M9□	5	15 Note 1)	40 Note 1)	$20 + 35 \frac{(n-2)}{2}$ (n = 2, 4, 6... Note 3)	$55 + 35 (n-2)$ (n = 2, 3, 4, 5...)	
D-M9□W	10	15 Note 1)	40 Note 1)	$20 + 35 \frac{(n-2)}{2}$ (n = 2, 4, 6... Note 3)	$55 + 35 (n-2)$ (n = 2, 3, 4, 5...)	
D-M9□A	10	25	40 Note 1)	$25 + 35 \frac{(n-2)}{2}$ (n = 2, 4, 6... Note 3)	$60 + 35 (n-2)$ (n = 2, 3, 4, 5...)	
D-A9□	5	15	30 Note 1)	$15 + 35 \frac{(n-2)}{2}$ (n = 2, 4, 6... Note 3)	$50 + 35 (n-2)$ (n = 2, 3, 4, 5...)	
D-M9□V	5	20	35	$20 + 35 \frac{(n-2)}{2}$ (n = 2, 4, 6... Note 3)	$35 + 35 (n-2)$ (n = 2, 3, 4, 5...)	
D-A9□V	5	15	25	$15 + 35 \frac{(n-2)}{2}$ (n = 2, 4, 6... Note 3)	$25 + 35 (n-2)$ (n = 2, 3, 4, 5...)	
D-M9□WV D-M9□AV	10	20	35	$20 + 35 \frac{(n-2)}{2}$ (n = 2, 4, 6... Note 3)	$35 + 35 (n-2)$ (n = 2, 3, 4, 5...)	
D-C7□ D-C80	5	15	50	$15 + 45 \frac{(n-2)}{2}$ (n = 2, 4, 6... Note 3)	$50 + 45 (n-2)$ (n = 2, 3, 4, 5...)	
D-H7□ D-H7□W D-H7BA D-H7NF	10	15	60	$15 + 45 \frac{(n-2)}{2}$ (n = 2, 4, 6... Note 3)	$60 + 45 (n-2)$ (n = 2, 3, 4, 5...)	
D-H7C D-C73C D-C80C	5	15	65	$15 + 50 \frac{(n-2)}{2}$ (n = 2, 4, 6... Note 3)	$65 + 50 (n-2)$ (n = 2, 3, 4, 5...)	
D-G5□ D-K59□ D-B5□ D-B64	5	15	75	$15 + 50 \frac{(n-2)}{2}$ (n = 2, 4, 6... Note 3)	$75 + 55 (n-2)$ (n = 2, 3, 4, 5...)	
D-B59W	10	20	75	$20 + 50 \frac{(n-2)}{2}$ (n = 2, 4, 6... Note 3)	$75 + 55 (n-2)$ (n = 2, 3, 4, 5...)	

Note 1) Auto switch mounting

Note 3) When "n" is an odd number, an even number that is one larger than this odd number is used for the calculation.

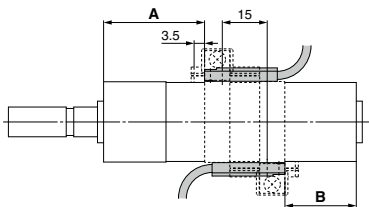
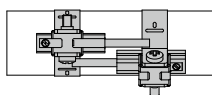
Auto switch model	With 2 auto switches	
	Different surfaces Note 1)	Same surface Note 1)
	 <p>Correct auto switch mounting position is 3.5 mm from the back face of the switch holder.</p>	 <p>The auto switch is mounted by slightly displacing it in a direction (cylinder tube circumferential exterior) so that the auto switch and lead wire do not interfere with each other.</p>
D-M9□ D-M9□W	Less than 20 stroke Note 2)	Less than 55 stroke Note 2)
D-M9□A	Less than 20 stroke Note 2)	Less than 60 stroke Note 2)
D-A9□	—	Less than 50 stroke Note 2)

Note 2) Minimum stroke for auto switch mounting in types other than those mentioned in Note 1.



**Auto Switch Mounting Brackets/Part No.**

Auto switch model	Bore size (mm)							
	20	25	32	40	50	63	80	100
D-M9□(V) D-M9□W(V) D-A9□(V)	Note 1) BMA3-020 (A set of a, b, c, d)	Note 1) BMA3-025 (A set of a, b, c, d)	Note 1) BMA3-032 (A set of a, b, c, d)	Note 1) BMA3-040 (A set of a, b, c, d)	Note 1) BMA3-050 (A set of a, b, c, d)	Note 1) BMA3-063 (A set of a, b, c, d)	—	—
D-M9□A(V) Note 2)	BMA3-020S (A set of b, c, e, f)	BMA3-025S (A set of b, c, e, f)	BMA3-032S (A set of b, c, e, f)	BMA3-040S (A set of b, c, e, f)	BMA3-050S (A set of b, c, e, f)	BMA3-063S (A set of b, c, e, f)	—	—

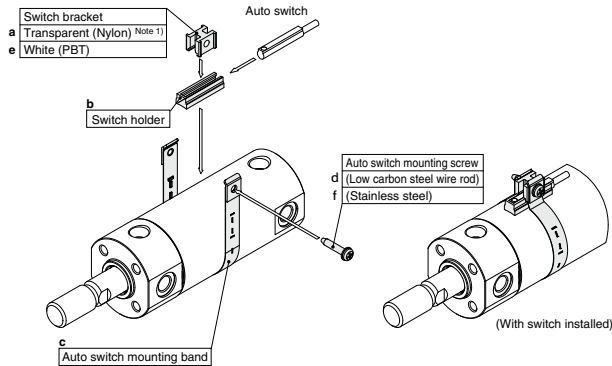

\* Band (c) is mounted so that the projected part is on the internal side (contact side with the tube).

D-H7□ D-H7□W D-H7NF D-C7□/C80 D-C73C/C80C	BMA2-020A (A set of c and d)	BMA2-025A (A set of c and d)	BMA2-032A (A set of c and d)	BMA2-040A (A set of c and d)	BMA2-050A (A set of c and d)	BMA2-063A (A set of c and d)	—	—
D-H7BA	BMA2-020AS (A set of c and f)	BMA2-025AS (A set of c and f)	BMA2-032AS (A set of c and f)	BMA2-040AS (A set of c and f)	BMA2-050AS (A set of c and f)	BMA2-063AS (A set of c and f)	—	—
D-G5□/K59 D-G5□W/K59W D-G5BA/G59F D-G5NT D-B5□/B64 D-B59W	BA-01 (A set of c and d)	BA-02 (A set of c and d)	BA-32 (A set of c and d)	BA-04 (A set of c and d)	BA-05 (A set of c and d)	BA-06 (A set of c and d)	BA-08 (A set of c and d)	BA-10 (A set of c and d)

Note 1) Since the switch bracket (made from nylon) are affected in an environment where alcohol, chloroform, methylamines, hydrochloric acid or sulfuric acid is splashed over, so it cannot be used.  
Please contact SMC regarding other chemicals.

Note 2) When mounting a D-M9□A(V) type auto switch, if the switch bracket is mounted on the indicator light, it may damage the auto switch. Therefore, be sure to avoid mounting the switch bracket on the indicator light.

**Band Mounting Brackets Set Part No.**

Set part no.	Contents
<b>BJ4-1</b>	- Switch bracket (White/PBT) (e) - Switch holder (b)
<b>BJ5-1</b>	- Switch bracket (Transparent/Nylon) (a) - Switch holder (b)

**[Stainless Steel Mounting Screw]**

The following stainless steel mounting screw kit is available. Use it in accordance with the operating environment.  
(Since the auto switch mounting bracket is not included, order it separately.)

BBA3: D-B5/B6/G5/K5 types

Note) Refer to page 1369 for details on the BBA3.







When the D-G5BA type auto switch is shipped independently, the BBA3 is attached.

## Operating Range

Auto switch model	Bore size (mm)							
	20	25	32	40	50	63	80	100
D-M9□(V) D-M9□W(V) D-M9□A(V)	4.5	5.0	4.5	5.5	5.0	5.5	—	—
D-A9□	7	6	8	8	8	9	—	—
D-C7/C80 D-C73C/C80C	8	10	9	10	10	11	—	—
D-B5□/B64 D-B59W	8	10	9	10	10	11	11	11
D-H7□/H7□W D-H7NF/H7BA	4	4	4.5	5	6	6.5	—	—
D-H7C	7	8.5	9	10	9.5	10.5	—	—
D-G5□/G5□W/G59F D-G5BA/K59/K59W	4	4	4.5	5	6	6.5	6.5	7
D-G5NT	4	4	4.5	5	6	6.5	6.5	7

\* Values which include hysteresis are for guideline purposes only, they are not a guarantee (assuming approximately ±30% dispersion) and may change substantially depending on the ambient environment.

## Cylinder Mounting Bracket, by Stroke/Auto Switch Mounting Surfaces

Auto switch model	Basic, Foot, Flange, Clevis			Trunnion		
	With 1 pc. (Rod cover side)	With 2 pcs. (Different surfaces)	With 2 pcs. (Same surface)	With 1 pc. (Rod cover side)	With 2 pcs. (Different surfaces)	With 2 pcs. (Same surface)
Auto switch mounting surface	Port surface 	Port surface 	Port surface 			
Auto switch type						
D-M9□(V) D-M9□W(V) D-M9□A(V) D-A9□	10 st or more	15 to 44 st	45 st or more	10 st or more	15 to 44 st	45 st or more
D-C7/C8	10 st or more	15 to 49 st	50 st or more	10 st or more	15 to 49 st	50 st or more
D-H7□/H7□W D-H7BA/H7NF	10 st or more	15 to 59 st	60 st or more	10 st or more	15 to 59 st	60 st or more
D-H7C/C73C/C80C	10 st or more	15 to 64 st	65 st or more	10 st or more	15 to 64 st	65 st or more
D-G5/K5/B5/B6 D-G5□W/K59W/G5BA D-G59F/G5NT	10 st or more	15 to 74 st	75 st or more	10 st or more	15 to 74 st	75 st or more
D-B59W	15 st or more	20 to 74 st	75 st or more	15 st or more	20 to 74 st	75 st or more

\* Trunnion type is not available for ø80 and ø100.

\* Adjust the auto switch mounting angle according to the customer's application.

**Other than the applicable auto switches listed in "How to Order", the following auto switches are mountable.**

Refer to pages 1271 to 1365 for the detailed specifications.

Type	Model	Electrical entry	Features	Applicable bore size	
Solid state	D-H7A1, H7A2, H7B	Grommet (In-line)	—	ø20 to ø63	
	D-H7NW, H7PW, H7BW		Diagnostic indication (2-color indicator)		
	D-H7BA		Water resistant (2-color indicator)		
	D-G5NT		With timer	ø20 to ø100	
Reed	D-C73, C76		—	Without indicator light	ø20 to ø63
	D-C80		—		
	D-B53		—	ø20 to ø100	

\* With pre-wired connector is also available for solid state auto switches. For details, refer to pages 1340 and 1341.

\* Normally closed (NC = b contact) solid state auto switches (D-M9□E(V)) are also available. For details, refer to page 1290.



## 1 PTFE Grease

Symbol

**-X446**

Applicable to environments incompatible with mineral oil  
PTFE grease (fluorine grease) is used as the lubricating grease.

### Applicable Series

Description	Model	Action	Note
Standard type	CG1	Double acting, Single rod	Except with air cushion

### How to Order

Standard model no.

- X446

PTFE grease ●

**Specifications: Same as standard type**

**Dimensions: Same as standard type**

\* When grease is necessary for maintenance, grease pack is available,  
please order it separately.  
GR-F-005 (Grease: 5 g)



# CG1 Series

## Specific Product Precautions 1

Be sure to read this before handling the products. Refer to page 20 for safety instructions and pages 21 to 30 for actuator and auto switch precautions.

### <Precautions on each series>

#### Handling

##### ⚠ Warning

1. Do not operate the cushion valve in the fully closed or fully opened state.

Using it in the fully closed state will cause the cushion seal to be damaged. Using it in the fully opened state will cause the piston rod assembly or the cover to be damaged.

2. Do not turn the cushion valve the number of rotations shown below or more from its fully closed state.

If it is turned the number of rotations shown below or more, the cushion valve may come off.

Bore size (mm)	Rotations	Hexagon wrench nominal size
20	2	1.5
25	4.5	1.5
32	4.5	1.5
40	5	1.5
50	3	3
63	4.5	3
80	5	4
100	5	4

3. Do not open the cushion valve after rotating it numerous times in a row. Though uncommon, there are cases in which the cushion valve may leak air.

The cushion valve should be adjusted by gradually opening it while checking the operation of the cylinder cushion. In the unlikely event that air leakage occurs, return the cushion needle to the fully-closed state, and readjust the cushion needle to the desired position.

4. Operate within the specified cylinder speed and kinetic energy. Otherwise, cylinder and seal damage may occur.

5. When a cylinder is operated with one end fixed and other free (basic, flange types), a bending moment may act on the cylinder due to the vibration generated at the stroke end, which can damage the cylinder. In such a case, install a mounting bracket to suppress the vibration of the cylinder body or reduce the piston speed so that the cylinder does not vibrate. Also, use a mounting bracket to suppress vibrations when moving the cylinder body or when a cylinder is operated horizontally and fixed at one end at a high speed and frequency.

##### ⚠ Caution

1. Use caution regarding the cushion performance in the low-speed range.

There may be individual performance and effect variances when used near 50 mm/s. Please consult with SMC about usage.

2. Do not apply excessive lateral load to the piston rod.

Easy checking method

Minimum operating pressure after the cylinder is mounted to the equipment (MPa) = Minimum operating pressure of cylinder (MPa) + (Load weight (kg) × 9.8 × Friction coefficient of guide/Sectional area of cylinder (mm<sup>2</sup>))

If smooth operation is confirmed within the above value, the load on the cylinder is the resistance of the thrust only and it can be judged as having no lateral load.

3. Do not use the air cylinder as an air-hydro cylinder.

This may result in oil leak.

4. Install a rod boot without twisting.

If the cylinder is installed with its bellows twisted, it could damage the bellows.

5. Tighten clevis bracket mounting bolts with the following proper tightening torque.

ø20: 1.5 N·m, ø25 to 32: 2.9 N·m, ø40: 4.9 N·m,

ø50: 11.8 N·m, ø63 to 80: 24.5 N·m, ø100: 42.2 N·m

#### Disassembly/Replacement

##### ⚠ Warning

1. Only people who have sufficient knowledge and experience are allowed to replace seals.

The person who disassembles and reassembles the cylinder is responsible for the safety of the product. Repeatedly disassembling and reassembling the product may cause wearing or deformation of the screws as well as a decline in screw tightening strength. When reassembling the product, be sure to check the cover and tubing screws for wear, deformities, or any other abnormalities. Operating the product with damaged screws may result in the cover or tubing coming off during operation, which could lead to a serious accident. Caution must be taken to avoid such incidents.

##### ⚠ Caution

1. Do not replace the bushings.

The bushings are press-fit. To replace them, they must be replaced together with the cover assembly.

2. To replace a seal, apply grease to the new seal before installing it.

If the cylinder is put into operation without applying grease to the seal, it could cause the seal to wear significantly, leading to premature air leakage.

3. Cylinders with ø50 or larger bore sizes cannot be disassembled.

When disassembling cylinders with bore sizes of ø20 through ø40, grip the double flat part of either the tube cover or the rod cover with a vise and loosen the other side with a wrench or a monkey wrench etc., and then remove the cover. When re-tightening, tighten approximately 2 degrees more than the original position. (Cylinders with ø50 or larger bore sizes are tightened with a large tightening torque and cannot be disassembled. If disassembly is required, please contact SMC.)

4. When replacing seals, take care not to hurt your hand or finger on the corners of parts.

### <Precautions on the non-rotating rod type>

#### Handling

##### ⚠ Caution

1. Avoid using the air cylinder in such a way that rotational torque would be applied to the piston rod.

- If rotational torque is applied, the non-rotating guide will become deformed, thus affecting the non-rotating accuracy. Refer to the table below for the approximate values of the allowable range of rotational torque.

Allowable rotational torque (N·m or less)	ø20	ø25, ø32	ø40, ø50, ø63
	0.2	0.25	0.44

- To screw a bracket or a nut onto the piston rod, make sure to retract the piston rod entirely, and place a wrench over the flat portion of the rod that protrudes. Tighten it by giving consideration to prevent the tightening torque from being applied to the non-rotating guide.

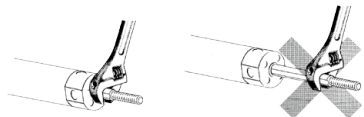

#### Disassembly/Replacement

##### ⚠ Caution

1. When replacing rod seals, please contact SMC.

Air leakage may be happened, depending on the position in which a rod seal is fitted. Thus, please contact SMC when replacing them.



## CG1 Series

# Specific Product Precautions 2

Be sure to read this before handling the products. Refer to page 20 for safety instructions and pages 21 to 30 for actuator and auto switch precautions.

### <End Lock Cylinder Precautions>

#### Use the Recommended Pneumatic Circuit

#### ⚠ Caution

- This is necessary for proper operation and release of the lock.

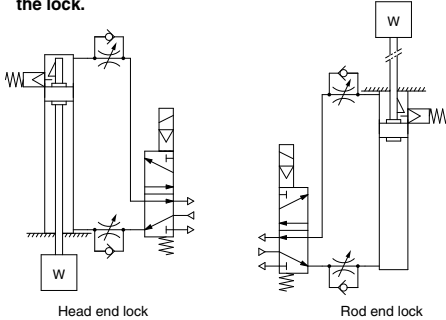

#### Handling

#### ⚠ Caution

- Do not use 3 position solenoid valves.**  
Avoid use in combination with 3 position solenoid valves (especially closed center metal seal types). If pressure is trapped in the port on the lock mechanism side, the cylinder cannot be locked. Furthermore, even after being locked, the lock may be released after some time, due to air leaking from the solenoid valve and entering the cylinder.
- Back pressure is required when releasing the lock.**  
Be sure air is supplied to the side of the cylinder without a lock mechanism, (side of the piston rod without lock for double end lock), before starting up, as in the above figures. Otherwise, the lock may not be released. (Refer to "Releasing the Lock".)
- Release the lock when mounting or adjusting the cylinder.**  
If mounting or other work is performed when the cylinder is locked, the lock unit may be damaged.
- Operate with a load ratio of 50% or less.**  
If the load ratio exceeds 50%, this may cause problems such as failure of the lock to release, or damage to the lock unit.
- Do not operate multiple cylinders in synchronization.**  
Avoid applications in which two or more cylinders with end lock are synchronized to move one workpiece, as one of the cylinder locks may not be able to release when required.
- Use a speed controller with meter-out control.**  
Lock cannot be released occasionally by meter-in control.
- Be sure to operate completely to the cylinder stroke end on the side with the lock.**  
If the cylinder piston does not reach the end of the stroke, locking and unlocking may not be possible.
- Do not use the air cylinder as an air-hydro cylinder.**  
This may result in oil leak.
- Install a rod boot without twisting.**  
If the cylinder is installed with its bellows twisted, it could damage the bellows.
- Adjust an auto switch position so that it operates for movement to both the stroke end and backlash (2 mm) positions.**  
When a 2-color indicator switch is adjusted for green indication at the stroke end, it may change to red for the backlash return, but this is not abnormal.

#### Handling

#### ⚠ Warning

- Do not operate the cushion valve in the fully closed or fully opened state.**  
Using it in the fully closed state will cause the cushion seal to be damaged. Using it in the fully opened state will cause the piston rod assembly or the cover to be damaged.
- Operate within the specified cylinder speed.**  
Otherwise, cylinder and seal damage may occur.

#### Operating Pressure

#### ⚠ Caution

- Supply air pressure of 0.15 MPa or higher to the port on the lock mechanism side, as it is necessary for releasing the lock.

#### Exhaust Speed

#### ⚠ Caution

- The lock will be engaged automatically if the pressure applied to the port on the lock mechanism side falls to 0.05 MPa or less. In cases where the piping on the lock mechanism side is long and thin, or the speed controller is separated at some distance from the cylinder port, the exhaust speed will be reduced. Take note that some time may be required for the lock to engage. In addition, clogging of a silencer mounted on the solenoid valve exhaust port can produce the same effect.

#### Relation to Cushion

#### ⚠ Caution

- When cushion valve at lock mechanism side is fully opened or closed, piston rod may not be reached at stroke end. Thus, lock is not established. And when locking is done at cushion valve fully closed, adjust cushion valve since lock may not be released.

#### Releasing the Lock

#### ⚠ Warning

- Before releasing the lock, be sure to supply air to the side without a lock mechanism, so that there is no load applied to the lock mechanism when it is released. (Refer to the recommended pneumatic circuits.) If the lock is released when the port on the other side is in an exhaust state, and with a load applied to the lock unit, the lock unit may be subjected to an excessive force and be damaged. Furthermore, sudden movement of the piston rod is very dangerous.

#### Disassembly/Replacement

#### ⚠ Caution

- Do not replace the bushings.**  
The bushings are press-fit. To replace them, they must be replaced together with the cover assembly.
- To replace a seal, apply grease to the new seal before installing it.**  
If the cylinder is put into operation without applying grease to the seal, it could cause the seal to wear significantly, leading to premature air leakage.
- Cylinders with  $\phi 50$  or larger bore sizes cannot be disassembled.**  
When disassembling cylinders with bore sizes of  $\phi 20$  through  $\phi 40$ , grip the double flat part of either the tube cover or the rod cover with a vise and loosen the other side with a wrench or a monkey wrench etc., and then remove the cover. When re-tightening, tighten approximately 2 degrees more than the original position. (Cylinders with  $\phi 50$  or larger bore sizes are tightened with a large tightening torque and cannot be disassembled. If disassembly is required, please contact SMC.)



# CG1 Series Specific Product Precautions 3

Be sure to read this before handling the products. Refer to page 20 for safety instructions and pages 21 to 30 for actuator and auto switch precautions.

## Manual Release

### ⚠ Caution

#### 1. Non-locking type manual release

Insert the accessory bolt from the top of the rubber cap (it is not necessary to remove the rubber cap), and after screwing it into the lock piston, pull it to release the lock. If you stop pulling the bolt, the lock will return to an operational state.

Thread sizes, pulling forces and strokes are as shown below.

Bore size (mm)	Thread size	Pulling force	Stroke (mm)
20, 25, 32	M2.5 x 0.45 x 25 L or more	4.9 N	2
40, 50, 63	M3 x 0.5 x 30 L or more	10 N	3
80, 100	M5 x 0.8 x 40 L or more	24.5 N	3

Remove the bolt for normal operation.

It can cause lock malfunction or faulty release.

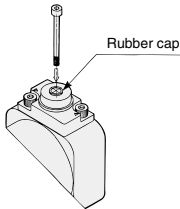

#### 2. Locking type manual release

While pushing the M/O knob, turn it 90° counterclockwise. The lock is released (and remains in a released state) by aligning the ▲ mark on the cap with the ▼OFF mark on the M/O knob.

When locking is desired, turn the M/O knob 90° clockwise while pushing completely down, and align the ▲ mark on the cap with the ▼ON mark on the M/O knob. The correct position is confirmed by a clicking sound.

Failure to click it into place properly can cause the lock to disengage.

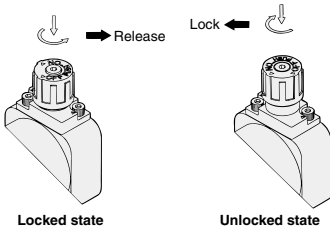

## Working Principle

\* The figures below are the same as those for CBA2 series.

### ● Head end lock (Rod end lock is the same.)

- When the piston rod is getting closer to the stroke end, the taper part (\*) of the piston rod edge will push the lock piston up.

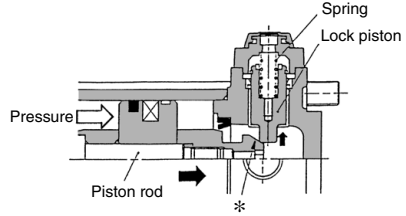

- The lock piston is pushed up further.

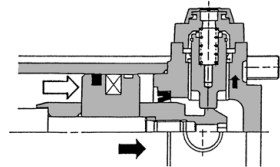

- The lock piston is pushed up into the groove of the piston rod to lock it. (The lock piston is pushed up by spring force.) At this time, it is exhausted from the port on the head side and introduced into the atmosphere.

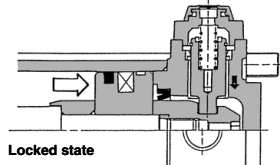

- When pressure is supplied in the head side, lock piston will be pushed up to release the lock.

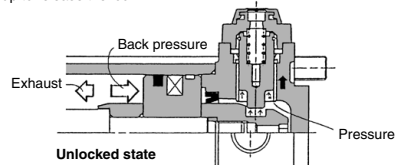

- When the lock is released, the cylinder will move forward.

