

Remote Type Pressure Sensors/Pressure Sensor Controllers

PSE Series

Compact Pneumatic Pressure Sensor **PSE530** ▶P.134



Compact Pneumatic Pressure Sensor **PSE540** ▶P.137

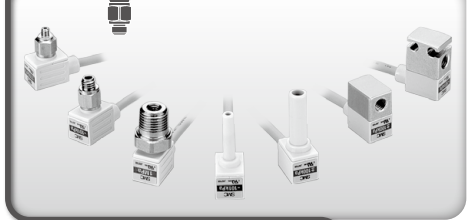

Low Differential Pressure Sensor **PSE550** ▶P.140



Pressure Sensor for General Fluids **PSE560** ▶P.143



Pressure Sensor for General Fluids **PSE570** ▶P.146



Multi-Channel Digital Pressure Sensor Controller **PSE200**

▶P.149



The PSE200 series now features a new model: the PSE200A. Click [here](#) for details.

2-Color Display Digital Pressure Sensor Controller **PSE300**

▶P.155









Connector type



DIN rail/Terminal block type

- ZSE20
- ZSE30
- ISE30
- ZSE40
- ISE40
- ZSE10
- ISE10
- ISE70
- ZSE80
- ISE80
- PS
- ISA3
- ISA2
- ISE35
- PSE**
- IS
- ISG
- ZSM1

PSE Series Variations

	Pressure Sensors					Controllers	
Model	PSE530  P.134	PSE540  P.137	PSE550  P.140	PSE560  P.143	PSE570  P.146	PSE200A  Click here for details.	PSE300  P.155

Basic Specifications	Fluid	Air			General fluids		
	Rated pressure range (Minimum display)						
	Repeatability	±1 % (F.S.)	±0.2 % (F.S.)	±0.3 % (F.S.)	±0.2 % (F.S.)	±0.2% (F.S.) PSE570/573/574 ±0.5% (F.S.) PSE575/576/577	±0.1 % (F.S.)
	Voltage	12 to 24 VDC					
	No. of outputs for switch					5 outputs	2 outputs
	Analog output	1 to 5 V		1 to 5 V 4 to 20 mA			1 to 5 V 4 to 20 mA
	Operating temp.	0 to 50°C			-10 to 60°C		0 to 50°C

Functions	Digital display				2-color		2-color	
	Enclosure	IP40			IP65		Front face IP65 Others IP40	IP40
	Wiring	Connector	Grommet			Connector	Connector	
	Major setting function						Keylock, Peak/Bottom values holding, Auto-preset, Auto-shift, Display calibration, Anti-chattering	

Others	Connection threads	M reducer	M R, NPT reducer	Resin piping	R, NPT, Rc URJ, TSJ*	R		
	Int'l standards	CE/UKCA	CE/UKCA, UL, CSA			CE/UKCA	CE/UKCA	CE/UKCA, UL, CSA
	Wiring	e-con	●	●	●	●	●	●
		Flexible cable		●	●			●
	Mounting	Direct	●	●	●	●	●	●
		With bracket		●				●
		Panel mount						●
DIN rail							●	

* URJ: Face seal fitting, TSJ: Compression fitting

Pressure Sensors/PSE5 Series

		PSE53	PSE54	PSE55	PSE56	PSE57
Vacuum	-101 kPa to 0	PSE531	PSE541	—	PSE561	—
Compound pressure	-100 kPa to 100 kPa	PSE533	PSE543	—	PSE563	PSE573
Positive pressure	0 to 100 kPa	PSE532	—	—	—	—
	0 to 500 kPa	—	—	—	PSE564	PSE574
	0 to 1 MPa	PSE530	PSE540	—	PSE560	PSE570
	0 to 2 MPa	—	—	—	—	PSE575
	0 to 5 MPa	—	—	—	—	PSE576
Low differential pressure	0 to 2 kPa	—	—	PSE550	—	—
	0 to 10 MPa	—	—	—	—	PSE577

Pressure Sensor Controllers/PSE200/300 Series

PSE200	PSE300	Input/Output specifications
		<ul style="list-style-type: none"> • NPN 2 outputs + 1-5 V output • NPN 2 outputs + 4-20 mA output • NPN 2 outputs + auto-shift input • PNP 2 outputs + 1-5 V output • PNP 2 outputs + 4-20 mA output • PNP 2 outputs + auto-shift input
Input/Output specifications <ul style="list-style-type: none"> • NPN 5 outputs + auto-shift input • PNP 5 outputs + auto-shift input 		

Applicable pressure sensor model					Set/Display resolution	
PSE531	PSE541	—	PSE561	—	0.1 kPa	0.1 kPa
PSE533	PSE543	—	PSE563	PSE573	0.1 kPa	0.2 kPa
PSE532	—	—	—	—	0.1 kPa	0.1 kPa
—	—	—	PSE564	PSE574	—	1 kPa
PSE530	PSE540	—	PSE560	PSE570	0.001 MPa	0.001 MPa
—	—	PSE550	—	—	—	0.01 kPa

Main Functions (For details, refer to pages 162 to 164.)

Keylock	Locks the keys from functioning.
Peak/Bottom values holding	Displays the maximum and minimum values being set and can keep those values on the display.
Auto-preset	Able to set the pressure automatically. In the case of suction verification, it memorizes the pressure when adsorbed and released. By repeating several times, the optimum values are calculated automatically.
Auto-shift	Stable switch output is available even though the supply pressure may fluctuate. Automatically corrects the set value in accordance with the fluctuations in the supply pressure.
Display calibration	Able to adjust the displayed value (±5%) and justify distribution of the values displayed on respective pressure switch.
Anti-chattering	Prevents malfunction due to sharp pressure fluctuations. The detection of momentary pressure fluctuation as abnormal pressure can be prevented by changing the setting of the response time.

ZSE20
ISE20
ZSE30
ISE30
ZSE40
ISE40
ZSE10
ISE10
ISE70
ZSE80
ISE80
PS
ISA3
ISA2
ISE35
PSE
IS
ISG
ZSM1

Compact Pneumatic Pressure Sensor

PSE530 Series



RoHS

Series	Rated pressure range				
	-100 kPa	0	100 kPa	500 kPa	1 MPa
PSE530		0	1 MPa		
PSE531	-101 kPa	0			
PSE532		0	101 kPa		
PSE533	-101 kPa		101 kPa		

Connector type

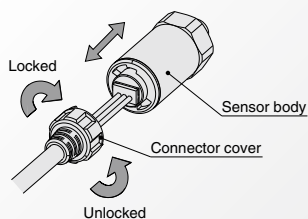

Application example

Leak test of radiator PSE532 + PSE300 Series

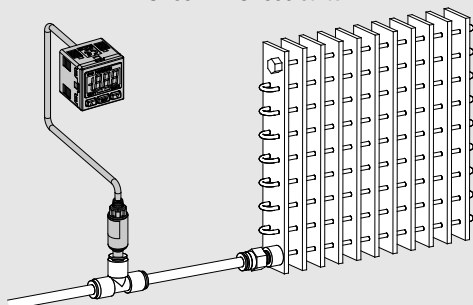

Low pressure sensor (PSE532-□) is used to detect minute differentiations. Auto-shift function reduces influence of fluctuations in the supply pressure.

Applications

Pressure Sensor PSE530 Series



How to Order

PSE53 0 - M5 - []

Sensor range	
0	Positive pressure [0 to 1 MPa]
1	Vacuum [0 to -101 kPa]
2	Low pressure [0 to 101 kPa]
3	Compound pressure [-101 to 101 kPa]

Port size	
M5	M5 x 0.8
R06	ø6 reducer
R07	1/4 inch reducer

Option

Nil	None
	Sensor cable (3 m)
L	
	Connector for pressure sensor controller (1 pc.) + Sensor cable (3 m)
C2L	

Note) The connector is not attached to the cable, but is included with the shipment.

Option/Part No.

When only optional parts are required, order using the part numbers listed below.

Description	Part no.	Note
Connector for pressure sensor controller	ZS-28-C	1 pc. per set
Sensor cable	ZS-26-F	Cable length: 3 m
Connector for pressure sensor controller + Sensor cable	ZS-26-J	Cable length: 3 m The connector is not attached to the cable at the time of shipment.

Refer to pages 11 and 12 for Pressure Switch Precautions. For details about the Specific Product Precautions, refer to the Operation Manual on the SMC website, <http://www.smcworld.com> Click [here](#) for details.

Specifications

Model	PSE530 (Positive pressure)	PSE531 (Vacuum)	PSE532 (Low pressure)	PSE533 (Compound pressure)
Rated pressure range	0 to 1 MPa	0 to -101 kPa	0 to 101 kPa	-101 to 101 kPa
Extension analog output range	-0.1 to 0 MPa	10.1 to 0 kPa	-10.1 to 0 kPa	—
Proof pressure	1.5 MPa		500 kPa	
Applicable fluid	Air/Non-corrosive gas/Non-flammable gas			
Power supply voltage	12 to 24 VDC ±10%, Ripple (p-p) 10% or less (with reverse connection protection)			
Current consumption	15 mA or less (with no load)			
Output specifications	Analog output 1 to 5 V (within rated pressure range), 0.6 to 1 V (within extension analog output range), Output impedance: Approx. 1 kΩ			
Accuracy (Ambient temperature at 25°C)	±2% F.S. (within rated pressure range), ±5% F.S. (within extension analog output range)			
Linearity	±1% F.S.			
Repeatability	±1% F.S.			
Power supply voltage effect	±1% F.S. based on the analog output at 18 V ranging from 12 to 24 VDC			
Environment	Enclosure	IP40		
	Temperature range	Operating: 0 to 50°C; Stored: -10 to 70°C (No freezing or condensation)		
	Withstand voltage	1000 VAC (in 50/60 Hz) for 1 minute between terminals and housing		
	Insulation resistance	5 MΩ or more (500 VDC measured via megohmmeter) between terminals and housing		
Temperature characteristics	±2% F.S. (25°C reference)			
Sensor cable/Option	Halogen-free heavy-duty cable, 3 cores, ø2.7, 3 m, Conductor area: 0.15 mm ² , Insulator O.D.: 0.8 mm			
Standards	CE/UKCA marking			

Piping Specifications

Model	M5	R06	R07
Port size	M5 x 0.8 male thread	ø6 reducer type	1/4 inch reducer type
Materials of parts in contact with fluid	Pressure sensor: Silicon, O-ring: NBR		
	Body: Stainless steel 304	Body: PBT	
Weight	With sensor cable (3 m)	41 g	38 g
	Without sensor cable	7 g	3.8 g

ZSE20
ISE20
ZSE30
ISE30
ZSE40
ISE40
ZSE10
ISE10
ISE70
ZSE80
ISE80
PS
ISA3
ISA2
ISE35
PSE
IS
ISG
ZSM1

PSE530 Series

Internal Circuit and Wiring Example

PSE53□

Voltage output type
1 to 5 V
Output impedance
Approx. 1 k Ω

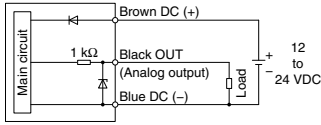

Analog Output

1 to 5 VDC

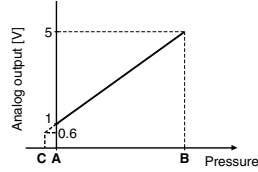

Range	Rated pressure range	A	B	C
For vacuum	0 to -101 kPa	0	-101 kPa	10.1 kPa
For compound pressure	-101 kPa to 101 kPa	-101 kPa	101 kPa	—
For low pressure	0 to 101 kPa	0	101 kPa	-10.1 kPa
For positive pressure	0 to 1 MPa	0	1 MPa	-0.1 MPa

Dimensions

PSE53□-M5

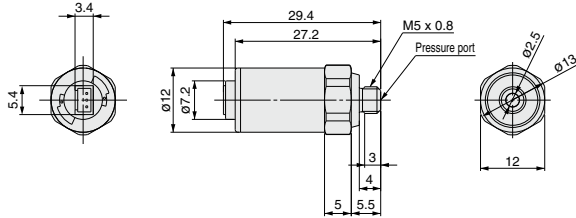

PSE53□-R06 R07

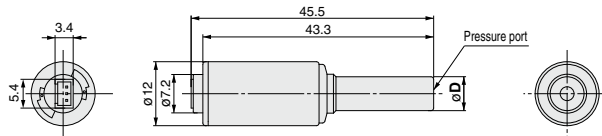

Model	Applicable fitting size (D)
PSE53□-R06	6
PSE53□-R07	1/4"

With sensor cable

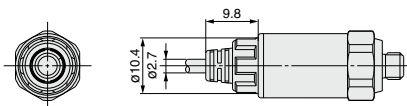

Compact Pneumatic Pressure Sensor

PSE540 Series



Series	Rated pressure range				
	-100 kPa	0	100 kPa	500 kPa	1 MPa
PSE540		0	1 MPa		
PSE541	-101 kPa	0			
PSE543	-100 kPa		100 kPa		

- Weight: 2.9 g
- Head size: 9.6 x 20.8 x 18 mm

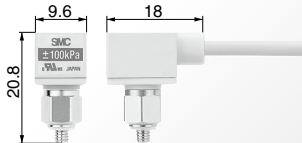

For PSE54□-M3

Application examples

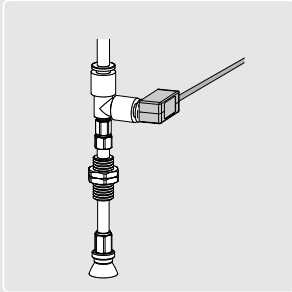

Pads can be directly mounted.

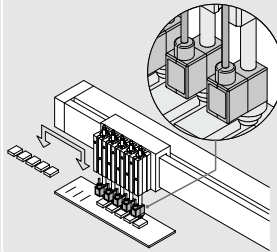

Manifolding is possible.

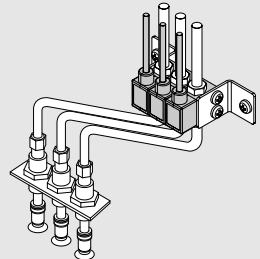

Applications

ZSE20
ISE20

ZSE30
ISE30

ZSE40
ISE40

ZSE10
ISE10

ISE70

ZSE80
ISE80

PS

ISA3

ISA2

ISE35

PSE

IS

ISG

ZSM1

Compact Pneumatic Pressure Sensor

PSE540 Series



How to Order



Sensor range

0	Positive pressure [0 to 1 MPa]
1	Negative pressure [0 to -101 kPa]
3	Compound pressure [-100 to 100 kPa]

Accuracy

Nil	±2% F.S.
A	±1% F.S.









Option (Connector)

Nil	None
C2	Connector for pressure sensor controller (1 pc.) 

Note) The connector is not attached to the cable, but is included with the shipment.

PSE54 **1** - **M3** -

Port size

M3	M3 x 0.5		IM5	M5 female thread, through type	
M5	M5 x 0.8		IM5H	M5 female thread, through type (with mounting hole)	
01	R1/8 (with M5 female thread)				
N01	NPT1/8 (with M5 female thread)				
R04	ø4 reducer				
R06	ø6 reducer				

Option/Part No.

Description	Part no.	Note
Connector for pressure sensor controller	ZS-28-C	1 pc.

Specifications

Refer to pages 11 and 12 for Pressure Switch Precautions. For details about the Specific Product Precautions, refer to the Operation Manual on the SMC website, <http://www.smcworld.com> Click [here](#) for details.

Model	PSE540	PSE541	PSE543
Rated pressure range	0 to 1 MPa	0 to -101 kPa	-100 to 100 kPa
Extension analog output range	-0.1 to 0 MPa	10.1 to 0 kPa	—
Proof pressure	1.5 MPa	500 kPa	
Applicable fluid	Air/Non-corrosive gas/Non-flammable gas		
Power supply voltage	12 to 24 VDC ±10%, Ripple (p-p) 10% or less (with reverse connection protection)		
Current consumption	15 mA or less		
Output specifications	Analog output 1 to 5 V (within rated pressure range), 0.6 to 1 V (within extension analog output range), Output impedance: Approx. 1 kΩ		
Accuracy (Ambient temperature at 25°C)	PSE54□: ±2% F.S. (within rated pressure range), ±5% F.S. (within extension analog output range) PSE54□A: ±1% F.S. (within rated pressure range), ±3% F.S. (within extension analog output range)		
Linearity	±0.7% F.S. or less	±0.4% F.S.	
Repeatability	±0.2% F.S.		
Power supply voltage effect	±0.8% F.S.		
Environment	Enclosure	IP40	
	Operating temperature range	Operating: 0 to 50°C, Stored: -20 to 70°C (No freezing or condensation)	
	Operating humidity range	Operating/Stored: 35 to 85% RH (No condensation)	
	Withstand voltage	1000 VAC (in 50/60 Hz) for 1 minute between terminals and housing	
Insulation resistance	50 MΩ or more (500 VDC measured via megohmmeter) between terminals and housing		
Temperature characteristics	±2% F.S. (25°C reference)		
Sensor cable	Oilproof heavy-duty vinyl cable (ellipse), 3 cores, 2.7 x 3.2, 3 m, Conductor area: 0.15 mm ² , Insulator O.D.: 0.9 mm		
Standards	CE/UKCA marking, UL/CSA (E216656)		

Piping Specifications

Model	M3	M5	01	N01	R04	R06	IM5	IM5H
Port size	M3 x 0.5	M5 x 0.8	R1/8 M5 x 0.8	NPT1/8 M5 x 0.8	ø4 reducer	ø6 reducer	M5 female thread, through type	M5 female thread, through type (with mounting hole)
Material	Resin case: PBT Fitting: Stainless steel 303		Resin case: PBT Fitting: C3604BD		PBT		Resin case: PBT Fitting: A6063S-T5	
	Pressure sensing section Pressure sensor: Silicon, O-ring: NBR							
Weight	With sensor cable	42.4 g	42.7 g	49.3 g	41.4 g	41.6 g	43.3 g	44.1 g
	Without sensor cable	2.9 g	3.2 g	9.8 g	1.9 g	2.1 g	3.8 g	4.6 g

Internal Circuit and Wiring Example

PSE54□

Voltage output type
1 to 5 V
Output impedance
Approx. 1 k Ω

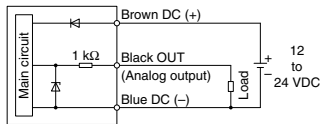

Analog Output

1 to 5 VDC

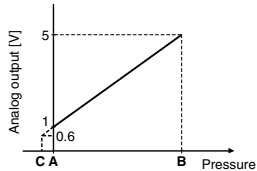

Range	Rated pressure range	A	B	C
For vacuum	0 to -101 kPa	0	-101 kPa	10.1 kPa
For compound pressure	-100 kPa to 100 kPa	-100 kPa	100 kPa	—
For positive pressure	0 to 1 MPa	0	1 MPa	-0.1 MPa

Dimensions

PSE54□-M3 M5

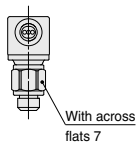
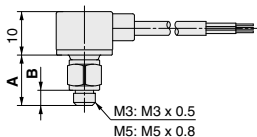

	PSE54□-M3	PSE54□-M5
A	10.8	11.5
B	3	3.5

PSE54□-R04 R06

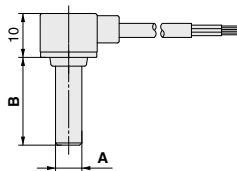

	PSE54□-R04	PSE54□-R06
A	ø4	ø6
B	18	20

Common Dimensions

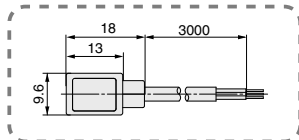

PSE54□-IM5

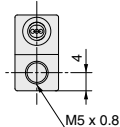
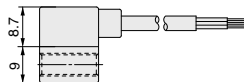

PSE54□-01 N01

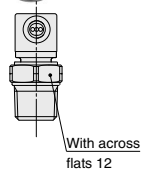
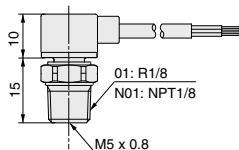

PSE54□-IM5H

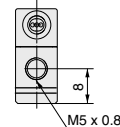
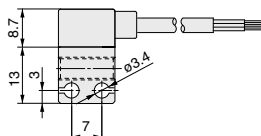

ZSE20
ISE20
ZSE30
ISE30
ZSE40
ISE40

ZSE10
ISE10

ISE70

ZSE80
ISE80

PS

ISA3

ISA2

ISE35

PSE

IS

ISG

ZSM1



Low Differential Pressure Sensor

PSE550 Series



Series	Rated pressure range		
	0	1 kPa	2 kPa
PSE550	0	2 kPa	

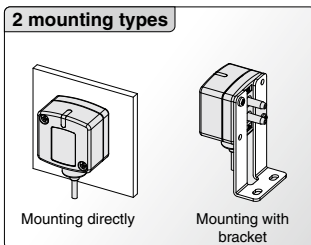
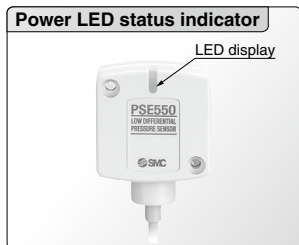

Application examples

Flow control
PSE550 Series

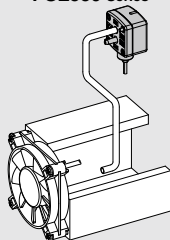

Can control air flow by monitoring the flow rate inside the duct.

Filter clogging monitoring
PSE550 Series

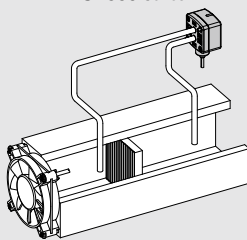

Can control filtration and replacement periods by monitoring the clogging of the filter.

Liquid level detection
PSE550 Series

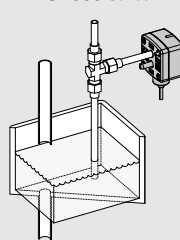

Can detect the liquid level through changes in the purge pressure.

Applications

Low Differential Pressure Sensor

PSE550 Series



How to Order

PSE550 - [] - [] - []

Output specifications

Nil	Voltage output type 1 to 5 V
28	Current output type 4 to 20 mA

Option 2 (Connector)

Nil	None
C2	Connector for pressure sensor controller (1 pc.)



Note 1) Not applicable to the PSE200 series.
 Note 2) The connector is not attached to the cable, but is included with the shipment.

Option 1 (Bracket)

Nil	None
A	Bracket

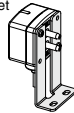

Note) The bracket is not attached to the product, but is included with the shipment.

Option/Part No.

Description	Part no.	Note
Bracket	ZS-30-A	With M3 x 5L (2 pcs.)
Connector for pressure sensor controller	ZS-28-C	1 pc.

Refer to pages 11 and 12 for Pressure Switch Precautions. For details about the Specific Product Precautions, refer to the Operation Manual on the SMC website, <http://www.smcworld.com> Click [here](#) for details.

Specifications

Model	PSE550	PSE550-28
Rated differential pressure range	0 to 2 kPa	
Operating pressure range	-50 to 50 kPa ^{Note)}	
Extension analog output range	-0.2 to 0 kPa	—
Proof pressure	65 kPa	
Applicable fluid	Air/Non-corrosive gas/Non-flammable gas	
Power supply voltage	12 to 24 VDC ±10%, Ripple (p-p) 10% or less (with reverse connection protection)	
Current consumption	15 mA or less	
Output specifications	Analog output: 1 to 5 VDC (within rated differential pressure range) 0.6 to 1 VDC (within extension analog output range) Output impedance: Approx. 1 kΩ	Analog output: 4 to 20 mA DC (within rated differential pressure range) Maximum load impedance: 500 Ω or less (at 24 VDC) 100 Ω or less (at 12 VDC)
Accuracy (Operating temperature at 25°C)	±1% F.S. (within rated differential pressure range), ±3% F.S. (within extension analog output range)	
Linearity	±0.5% F.S.	
Repeatability	±0.3% F.S.	
Indicator light	Orange light is turned on. (When energized)	
Environment	Enclosure IP40 Operating temperature range Operating: 0 to 50°C, Stored: -20 to 70°C (No freezing or condensation) Operating humidity range Operating/Stored: 35 to 85% RH (No condensation) Withstand voltage 1000 VAC (in 50/60 Hz) for 1 minute between terminals and housing Insulation resistance 50 MΩ or more (500 VDC measured via megohmmeter) between terminals and housing	
Temperature characteristics	±3% F.S. (25°C reference)	
Port size	ø4.8 (ø4.4 in the end) resin piping (Applicable to I.D. ø4 air tubing)	
Materials of parts in contact with fluid	Resin pipe: Nylon, Piston area of sensor: Silicon	
Sensor cable	Oilproof heavy-duty vinyl cable (ellipse), 3 cores, ø2.6, 3 m Conductor area: 0.15 mm ² , Insulator O.D.: 0.9 mm	Oilproof heavy-duty vinyl cable (ellipse), 2 cores, ø2.6, 3 m Conductor area: 0.15 mm ² , Insulator O.D.: 0.9 mm
Weight	With sensor cable 75 g Without sensor cable 35 g	
Standards	CE/UKCA marking, UL/CSA (E216656)	

Note) Can detect differential pressure from 0 to 2 kPa within the range of -50 to 50 kPa.

ZSE20
ISE20
ZSE30
ISE30
ZSE40
ISE40
ZSE10
ISE10
ISE70
ZSE80
ISE80
PS
ISA3
ISA2
ISE35
PSE
IS
ISG
ZSM1

PSE550 Series

Internal Circuit and Wiring Example

PSE550

Voltage output type
1 to 5 V
Output impedance
Approx. 1 k Ω

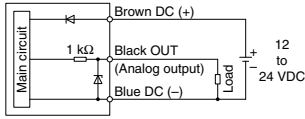

PSE550-28

Current output type
4 to 20 mA
Allowable load impedance
500 Ω or less (at 24 VDC)
100 Ω or less (at 12 VDC)

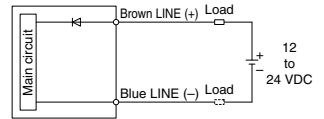

* Install the load either on the LINE (+) or LINE (-) side.

Analog Output

1 to 5 VDC

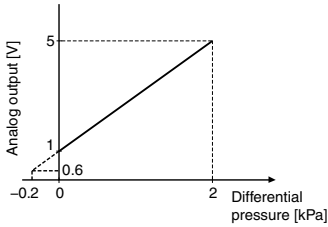

4 to 20 mA DC

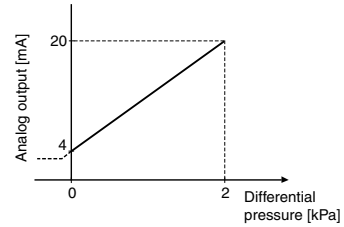

Dimensions

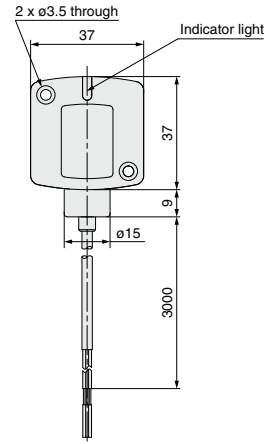
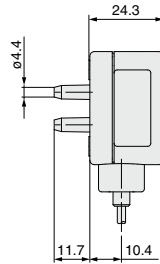
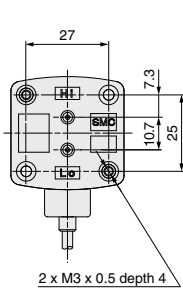

With bracket

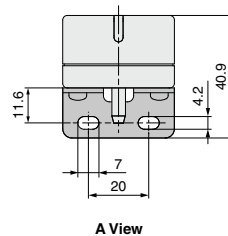
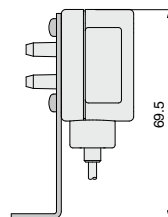
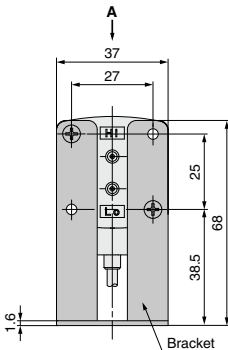



Pressure Sensor For General Fluids

PSE560 Series



Series	Rated pressure range				
	-100 kPa	0	100 kPa	500 kPa	1 MPa
PSE560		0	1 MPa		
PSE561	-101 kPa	0			
PSE563	-100 kPa		100 kPa		
PSE564		0		500 kPa	

Applicable fluids example

- Argon
- Air-containing drainage
- Refrigerant
- Nitrogen
- Hydraulic oil
- Silicone oil
- Water
- Carbon dioxide
- Lubricant
- Fluorocarbon
- Air

Material of parts
in contact with fluid
Stainless steel 316L

IP65

**Copper-free
Fluorine-free**

Oil-free
(Single diaphragm construction)

Variations

Port type	Thread type	Special fitting type for semiconductors
Port size	R1/8, R1/4, Rc1/8, NPT1/8, NPT1/4	URJ1/4, TSJ1/4*
Leakage	$1 \times 10^{-6} \text{Pa} \cdot \text{m}^3/\text{s}$	$1 \times 10^{-10} \text{Pa} \cdot \text{m}^3/\text{s}$
Analog output	1 to 5 V voltage output	
	4 to 20 mA current output	

* For URJ1/4, TSJ1/4, refer to "Glossary of Terms/Technical Information" on pages 182 to 196.

Application examples

Cleaning lines

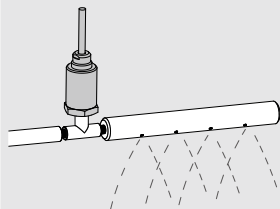

Check for working pressure for hydraulic cylinders

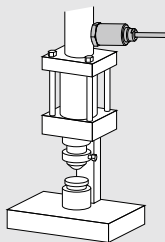

Suction verification of workpieces containing moisture

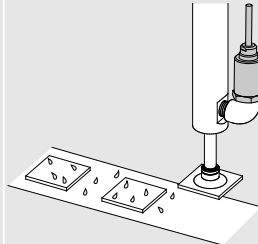

Note: When vacuum is released, take precautions to avoid water collision with inertia force. (An adapter with restrictor (ZS-31-X175) is available to prevent water collision with rush inertia.) (Refer to "NOTE" on the Operation Manual at SMC website for details.)

Applications

ZSE20
ISE20
ZSE30
ISE30
ZSE40
ISE40
ZSE10
ISE10
ISE70
ZSE80
ISE80
PS
ISA3
ISA2
ISE35
PSE
IS
ISG
ZSM1

Pressure Sensor For General Fluids

PSE560 Series



How to Order

Sensor range

0	Positive pressure [0 to 1 MPa]
1	Vacuum [0 to -101 kPa]
3	Compound pressure [-100 to 100 kPa]
4	Positive pressure [0 to 500 kPa]

PSE56 0-01-

Port size

01	R1/8 (with M5 female thread)
02	R1/4 (with M5 female thread)
C01	Rc1/8
N01	NPT1/8 (with M5 female thread)
N02	NPT1/4 (with M5 female thread)
A2	URJ1/4 (Face seal fitting)
B2	TSJ1/4 (Compression fitting)

Output specifications

Nil	Voltage output type 1 to 5 V
28	Current output type 4 to 20 mA

Option (Connector)

Nil	None
C2	Connector for pressure sensor controller (1 pc.)



Note 1) Current output type cannot be connected to the PSE200 series.
Note 2) The connector is not attached to the cable, but is included with the shipment.

Option/Part No.

Description	Part no.	Material	Note
Connector for pressure sensor controller	ZS-28-C	—	1 pc.
Adapter with restrictor Rc1/4	ZS-31-X175	—	1 pc.
Adapter with restrictor NPT1/4	ZS-31-X186	Stainless steel 304	1 pc.
Adapter with restrictor Rc1/8	ZS-31-X188	—	1 pc.
Adapter with restrictor NPT1/8	ZS-31-X189	—	1 pc.
Orifice M5	ZS-48-A	Stainless steel 303	1 pc.

Refer to pages 11 and 12 for Pressure Switch Precautions. For details about the Specific Product Precautions, refer to the Operation Manual on the SMC website, <http://www.smcworld.com> Click [here](#) for details.

Specifications

Model	PSE560 (Positive pressure)	PSE561 (Vacuum)	PSE563 (Compound pressure)	PSE564 (Positive pressure)
Rated pressure range	0 to 1 MPa	0 to -101 kPa	-100 to 100 kPa	0 to 500 kPa
Extension analog output range	-0.1 to 0 MPa	10.1 to 0 kPa	—	-50 to 0 kPa
Proof pressure	1.5 MPa	500 kPa	500 kPa	750 kPa

Model	PSE56□-□	PSE56□-□-28
Applicable fluid	Liquid or gas that will not corrode or attack stainless steel 316L	
Power supply voltage	12 to 24 VDC ±10%, Ripple (p-p) 10% or less (with reverse connection protection)	
Current consumption	10 mA or less	—
Output specifications	Analog output: 1 to 5 V (within rated pressure range) 0.6 to 1 V (within extension analog output range) Output impedance: Approx. 1 kΩ	Analog output: 4 to 20 mA DC (within rated pressure range) Maximum load impedance: 500 Ω or less (at 24 VDC) 100 Ω or less (at 12 VDC)
Accuracy (Ambient temperature at 25°C)	±1% F.S. (within rated pressure range), ±3% F.S. (within extension analog output range)	
Linearity	±0.5% F.S.	
Repeatability	±0.2% F.S.	
Power supply voltage effect	±0.3% F.S.	
Environment	Enclosure	IP65
	Operating temperature range	Operating: -10 to 60°C, Stored: -20 to 70°C (No freezing or condensation)
	Operating humidity range	Operating/Stored: 35 to 85% RH (No condensation)
	Withstand voltage	250 VAC for 1 minute between terminals and housing
Insulation resistance	50 MΩ or more (50 VDC measured via megohmmeter) between terminals and housing	
Temperature characteristics	±2% F.S. (0 to 50°C; 25°C reference), ±3% F.S. (-10 to 60°C; 25°C reference)	
Sensor cable	PSE56□-□: Oilproof heavy-duty vinyl cable with air tubing, 3 cores, ø5.1, 3 m, Conductor area: 0.2 mm ² , Insulator O.D.: 1.12 mm PSE56□-□-28: Oilproof heavy-duty vinyl cable with air tubing, 2 cores, ø5.1, 3 m, Conductor area: 0.2 mm ² , Insulator O.D.: 1.12 mm	
Standards	CE/UKCA marking, UL/CSA (E216656)	

Piping Specifications

Model	01	02	N01	N02	C01	A2	B2	
Port size	R1/8 M5 x 0.8	R1/4 M5 x 0.8	NPT1/8 M5 x 0.8	NPT1/4 M5 x 0.8	Rc1/8	URJ1/4	TSJ1/4	
Material	Case: C3604 + Nickel plating, Piping port/Pressure sensor: Stainless steel 316L, Grease-free							
Weight	With sensor cable	193 g	200 g	194 g	201 g	187 g	203 g	193 g
	Without sensor cable	101 g	108 g	102 g	109 g	95 g	111 g	101 g

Internal Circuit and Wiring Example

PSE56□-□

Voltage output type
1 to 5 V
Output impedance
Approx. 1 kΩ

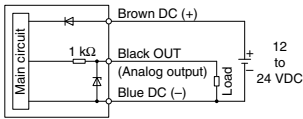

PSE56□-□-28

Current output type
4 to 20 mA
Allowable load impedance
500 Ω or less (at 24 VDC)
100 Ω or less (at 12 VDC)

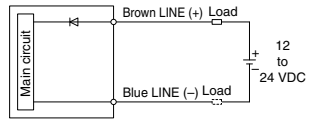

* Install the load either on the LINE (+) or LINE (-) side.

Analog Output

1 to 5 VDC

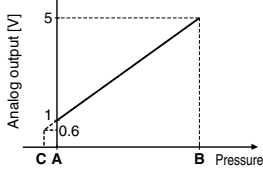

4 to 20 mA DC

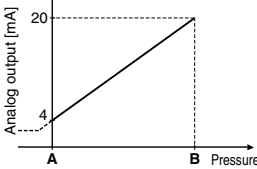

Range	Rated pressure range	A	B	C
For vacuum	0 to -101 kPa	0	-101 kPa	10.1 kPa
For compound pressure	-100 kPa to 100 kPa	-100 kPa	100 kPa	—
For positive pressure	0 to 1 MPa	0	1 MPa	-0.1 MPa
	0 to 500 kPa	0	500 kPa	-50 kPa

Dimensions

PSE56□-01, PSE56□-N01 02, PSE56□-N02

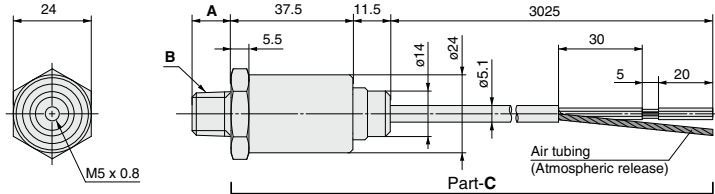

* The dimensions of part C are common to all PSE56□ models.

Be sure to release the air in the air tubing of the cable to the atmosphere. If the air tubing is restricted, or left in environments where it is exposed to water or oil, it cannot be detected normally.

PSE56□-C01

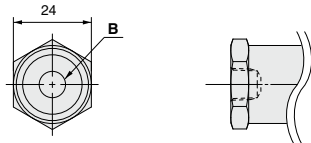

PSE56□-A2

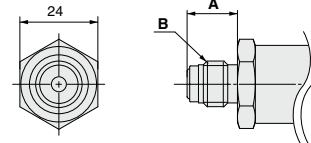

PSE56□-B2

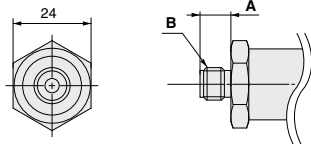

Adapter with restrictor

ZS-31-X□□□

Material:
Stainless steel 304

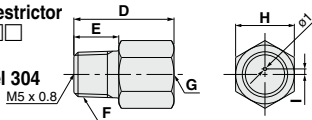

Orifice ZS-48-A

Material:
Stainless steel 303

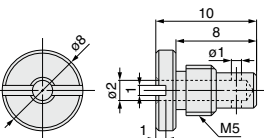

Model	A	B
PSE56□-01	8.2	R1/8
PSE56□-02	12	R1/4
PSE56□-N01	9.2	NPT1/8
PSE56□-N02	12.2	NPT1/4
PSE56□-C01	—	Rc1/8
PSE56□-A2	15.5	URJ1/4
PSE56□-B2	9.5	TSJ1/4

Part no.	D	E	F	G	H	I
ZS-31-X188	20	9	R1/8	Rc1/8	14	1.5
ZS-31-X189	20	9	NPT1/8	NPT1/8	14	1.5
ZS-31-X175	29	13	R1/4	Rc1/4	17	1.6
ZS-31-X186	29	13	NPT1/4	NPT1/4	17	1.6

Note) If it is predicted that the pressure, such as the water hammer or surge pressure fluctuates rapidly, refer to the Precautions stated in the Operation Manual at SMC website (<http://www.smcworld.com>).



Pressure Sensor For General Fluids

PSE570 Series



Series	Rated pressure range						
	0	100 kPa	500 kPa	1 MPa	2 MPa	5 MPa	10 MPa
PSE570		0	1 MPa				
PSE573	-100 kPa	100 kPa					
PSE574		0	500 kPa				
PSE575		0	2 MPa				
PSE576		0	5 MPa				
PSE577		0	10 MPa				

M12 connector



Materials of Parts in Contact with Fluid

	PSE570/573/574	PSE575/576/577
Piping port*	C3604 + Nickel plating	
Pressure sensor*	Al ₂ O ₃ (Alumina 96%)	
Sensor seal	FKM + Grease	FKM

* Stainless steel 316L is used for the PSE560.
For details, refer to page 143.

**Withstand
voltage**

500 VAC

<Twice that of the PSE560>

IP65

Application examples

Liquid coolant pressure control

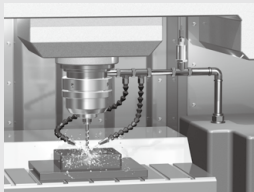

PET bottle molding machines

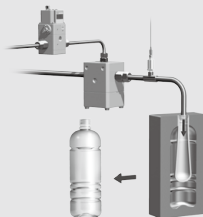

Liquid pressure control of gun drills

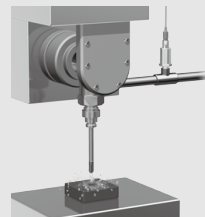

Applications

Pressure Sensor for General Fluids

PSE570 Series



How to Order

PSE57 0 - 01 - [] - []

Sensor range

0	Positive pressure [0 to 1 MPa]
3	Compound pressure [-100 to 100 kPa]
4	Positive pressure [0 to 500 kPa]
5	Positive pressure [0 to 2 MPa]
6	Positive pressure [0 to 5 MPa]
7	Positive pressure [0 to 10 MPa]

Option (Lead wire)

Nil	Lead wire and M12 connector (3 m), Straight	
L	Lead wire and M12 connector (3 m), Right angle	
N	None	

* See page 164-5 for connection to the PSE300AC.

Output specification

Nil	Voltage output type 1 to 5 V
2B	Current output type 4 to 20 mA

Port size

Symbol	Port size	Model					
		PSE570	PSE573	PSE574	PSE575	PSE576	PSE577
01	R1/8 (with M5 female thread)	●	●	●	●	●	●
02	R1/4 (with M5 female thread)	●	●	●	●	●	●

Options/Part Nos.

	Description	Part no.	Material	Note
①	Lead wire and M12 connector (3 m), Straight	ZS-37-A	—	1 pc.
②	Lead wire and M12 connector (3 m), Right angle	ZS-37-B	—	1 pc.
③	Assembly-type connector	PCA-1557743	—	1 pc.
④	Adapter with restrictor Rc1/4	ZS-31-X175	Stainless steel 304	1 pc.
⑤	Adapter with restrictor Rc1/8	ZS-31-X188	—	1 pc.
⑥	Orifice M5	ZS-48-A	Stainless steel 303	1 pc.
⑦	① + ③	ZS-37-A-X448	—	The lead wire and connector are shipped together. (but not assembled)
⑧	② + ③	ZS-37-B-X448	—	
⑨	Connector for pressure sensor controller connection	ZS-28-CA-4	—	1 pc.

Specifications

For pressure switch precautions and specific product precautions, refer to the "Operation Manual" on the SMC website. Click [here](#) for details.

Model		PSE570	PSE573	PSE574	PSE575	PSE576	PSE577
Fluid	Applicable fluid	Gas or liquid that will not corrode materials of parts in contact with fluid					
Pressure	Rated pressure range	0 to 1 MPa	-100 to 100 kPa	0 to 500 kPa	0 to 2 MPa	0 to 5 MPa	0 to 10 MPa
	Proof pressure	3.0 MPa	600 kPa	1.5 MPa	5.0 MPa	12.5 MPa	30 MPa
Electrical	Power supply voltage	12 to 24 VDC ±10% with 10% voltage ripple or less					
	Current consumption	10 mA or less					
	Protection	Reverse connection protection					
Accuracy	Analog output accuracy (Ambient temperature at 25°C)	±1.0% F.S.			±2.5% F.S.		
	Linearity	±0.5% F.S.			±0.5% F.S.		
	Repeatability (Ambient temperature at 25°C)	±0.2% F.S.			±0.5% F.S.		
	Temperature characteristics (25°C reference)	±2%F.S. (0 to 50°C) ±3%F.S. (-10 to 60°C)	±3% F.S. (0 to 50°C) ±4% F.S. (-10 to 60°C)		±5% F.S. (-10 to 60°C)		
Environment	Enclosure	IP65					
	Withstand voltage	500 VAC for 1 minute between terminals and housing					
	Insulation resistance	100 MΩ or more (500 VDC measured via megohmmeter) between terminals and housing					
	Operating temperature range	Operating: -10 to 60°C, Stored: -20 to 70°C (No freezing or condensation)					
Standards		Operating/Stored: 35 to 85% RH (No condensation) CE/UKCA marking					
Materials of parts in contact with fluid		Piping port: C3604 + Nickel plating, Pressure sensor: Al ₂ O ₃ (Alumina 96%), Sensor seal: FKM + Grease			Piping port: C3604 + Nickel plating, Pressure sensor: Al ₂ O ₃ (Alumina 96%), Sensor seal: FKM		
Analog output	Model	PSE57□□□□			PSE57□□□□-2B		
	Output	Voltage output: 1 to 5 V			Current output: 4 to 20 mA		
	Impedance	Output impedance: Approx. 1 kΩ			Maximum load impedance: 500 Ω or less (at 24 VDC) 100 Ω or less (at 12 VDC)		

Piping Specifications

Part no.		PSE570/573/574-01	PSE570/573/574-02	PSE575/576/577-02
Port size		R1/8 M5 x 0.8	R1/4 M5 x 0.8	R1/4 M5 x 0.8
	Materials of parts in contact with fluid	Piping port: C3604 + Nickel plating Pressure sensor: Al ₂ O ₃ (Alumina 96%) Sensor seal: FKM + Grease		Piping port: C3604 + Nickel plating Pressure sensor: Al ₂ O ₃ (Alumina 96%) Sensor seal: FKM
Weight	Without lead wire and M12 connector	88 g	95 g	103 g
	With lead wire and M12 connector	175 g	182 g	191 g

Cable Specifications

Conductor	Nominal cross section	AWG23
	Outside diameter	0.72 mm
Insulator	Material	Cross-linked vinyl chloride
	Outside diameter	1.14 mm
Color	Brown, Blue, Black, White	
Sheath Material	Oil resistant vinyl chloride	
Finished O.D.	ø4	
Length	3 m	

PSE570 Series

Internal Circuits and Wiring Examples

PSE57□-□
Voltage output type
1 to 5 V
Output impedance
Approx. 1 k Ω

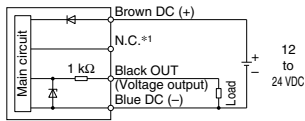

PSE57□-□-28
Current output type
4 to 20 mA
Allowable load impedance
500 Ω or less (at 24 VDC)
100 Ω or less (at 12 VDC)

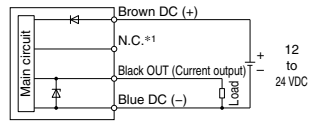

*1 The unconnected terminals are used in SMC, so please do not connect them.

Analog Output

1 to 5 VDC

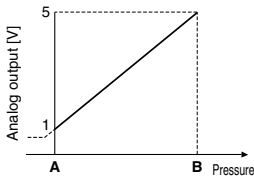

4 to 20 mA DC

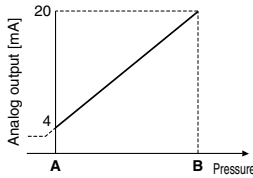

Model	Rated pressure range	A	B
PSE570	0 to 1 MPa	0 MPa	1 MPa
PSE573	-100 to 100 kPa	-100 kPa	100 kPa
PSE574	0 to 500 kPa	0 kPa	500 kPa
PSE575	0 to 2 MPa	0 MPa	2 MPa
PSE576	0 to 5 MPa	0 MPa	5 MPa
PSE577	0 to 10 MPa	0 MPa	10 MPa

Dimensions

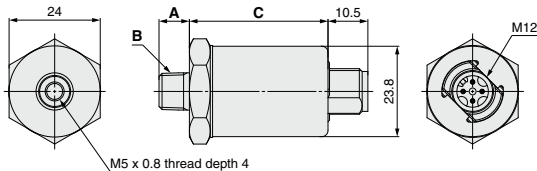

Part no.	[mm]		
	A	B	C
PSE570/573/574-01	8	R1/8	36.5
PSE570/573/574-02	12	R1/4	36.5
PSE575/576/577-02	12	R1/4	39.7

Lead wire and M12 connector

ZS-37-A

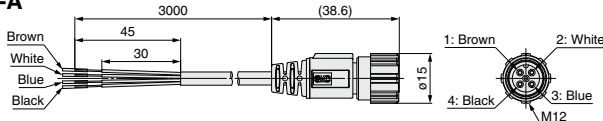

Pin no.	Lead wire color	Description
1	Brown	DC (+)
2	White	N.C.*1
3	Blue	DC (-)
4	Black	OUT1

*1 The unconnected terminals are used in SMC, so please do not connect them.

ZS-37-B

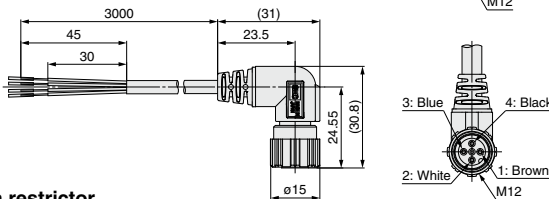

Part no.	Description
ZS-37-A	Straight type 3 m
ZS-37-B	Right angle type 3 m

Adapter with restrictor

ZS-31-X□□□

Material:
Stainless steel 304

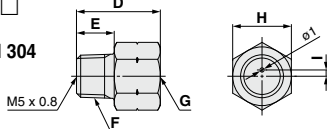

Part no.	[mm]					
	D	E	F	G	H	I
ZS-31-X188	20	9	R1/8	Rc1/8	14	1.5
ZS-31-X175	29	13	R1/4	Rc1/4	17	1.6

Orifice

ZS-48-A

Material:
Stainless steel 303

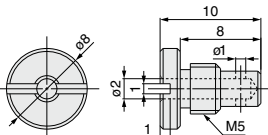

* If it is expected that the pressure, such as the water hammer or surge pressure will fluctuate rapidly, refer to the Precautions in the Operation Manual on the SMC website (<http://www.smcworld.com>).

Multi-Channel Digital Pressure Sensor Controller

PSE200 Series



RoHS

The PSE200 series now features a new model: the PSE200A. Click [here](#) for details.

Applicable sensors					Rated pressure range				Set/Display resolution
PSE53□	PSE54□	PSE55□	PSE56□	PSE57□	-100 kPa	0	100 kPa	1 MPa	
PSE531	PSE541	—	PSE561	—	-101 kPa	0			0.1 kPa
PSE533	PSE543	—	PSE563	PSE573	-101 kPa		101 kPa		0.1 kPa
PSE530	PSE540	—	PSE560	PSE570		0		1 MPa	0.001 MPa
PSE532		—		—		0	101 kPa		0.1 kPa

● A single controller monitors up to 4 pressure sensors.

- Sensor input: 4 inputs
- Switch output: 5 outputs (2 outputs for 1ch, 1 output for 2 to 4ch)

● Functions

- Auto-shift function
- Auto-preset function
- Auto-identification function
- Copy function
- Channel scan function
- Zero-clear function
- Keylock function
- Peak/Bottom values holding/display function
- Display unit switching function
- Display calibration function
- Anti-chattering function

76% reduction in installation space (Compared with the panel mounted ZSE40/ISE40)

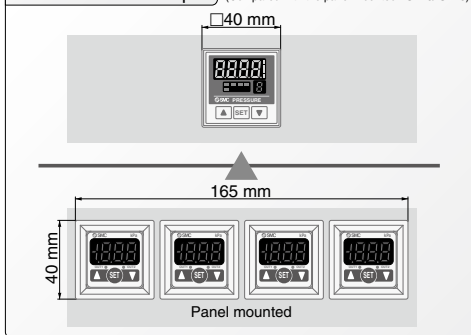

Connector type

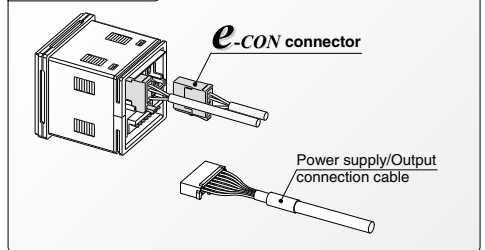

A single controller monitors various applications.

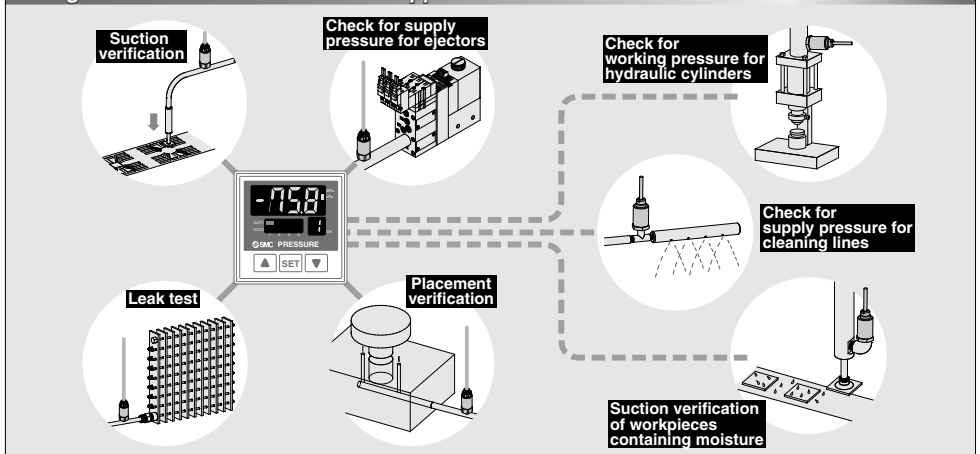

Multi-Channel Controller

PSE200 Series



The PSE200 series now features a new model; the PSE200A. Click [here](#) for details.



How to Order

PSE20 0 - M

Input/Output specifications

0	NPN 5 outputs + Auto-shift input
1	PNP 5 outputs + Auto-shift input

Unit specifications

Nil	With display unit switching function ^{Note 1)}
M	Fixed SI unit ^{Note 2)}

Note 1) Under the New Measurement Law, sales of switches with the unit switching function are not allowed for use in Japan.

Note 2) Fixed unit
For vacuum, low pressure and compound pressure: kPa
For positive pressure: MPa

Option 2

Nil	None
4C	Sensor connector (4 pcs.)

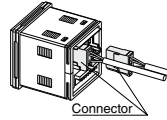

Note) This connector cannot be used with the PSE570 series.

Option 1

Nil	None
A	Panel mount adapter
B	Front protective cover + Panel mount adapter

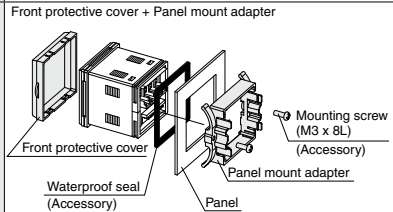
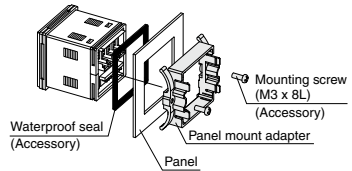

Accessory: Power supply/Output connection cable (2 m)

Included with the controller.

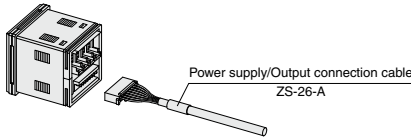

Option/Part No.

When only optional parts are required, order with the part numbers listed below.

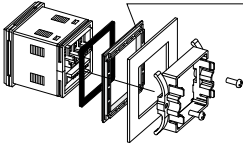
Description	Part no.	Note
Panel mount adapter	ZS-26-B	Waterproof seal, mounting screws M3 x 8L (2 pcs.) included
Front protective cover + Panel mount adapter	ZS-26-C	Waterproof seal, mounting screws M3 x 8L (2 pcs.) included
□48 conversion adapter	ZS-26-D	<div style="display: flex; align-items: center;"> <div style="margin-right: 10px;">□48 conversion adapter</div>  </div> <p>* This adapter is used to mount the PSE200 series on the panel fitting of the PSE100 series.</p> <p style="text-align: center;">Order panel mount adapter separately.</p>
Front protective cover	ZS-26-01	
Sensor connector (1 pc. per set)	ZS-28-C	For the PSE□□ series (Excludes the PSE570 series)
	ZS-28-CA-4	For PSE570 series

Specifications

Refer to pages 11 and 12 for Pressure Switch Precautions. For details about the Specific Product Precautions, refer to the Operation Manual on the SMC website, <http://www.smcworld.com> Click [here](#) for details.

Model		PSE200	PSE201
Power supply voltage		12 to 24 VDC $\pm 10\%$, Ripple (p-p) 10% or less (with reverse connection protection)	
Current consumption		55 mA or less (Current consumption for sensor is not included.)	
Power supply voltage for sensor		[Power supply voltage] -1.5 V	
Power supply current for sensor ^{Note 1)}		Maximum 40 mA (100 mA maximum for the total power supply current when 4 sensors are input.)	
Sensor input		1 to 5 VDC (Input impedance: Approx. 800 k Ω)	
	Number of inputs	4 inputs	
	Input protection	With excess voltage protection (Up to 26.4 V)	
Switch output		NPN open collector output: 5 outputs (Sensor input CH1: 2 outputs, CH2 to 4: 1 output)	PNP open collector output: 5 outputs (Sensor input CH1: 2 outputs, CH2 to 4: 1 output)
	Maximum load current	80 mA	
	Maximum load voltage	30 V	
	Residual voltage	1 V or less (with load current of 80 mA)	
	Response time	5 ms or less (Response time selections with anti-chattering function: 20 ms, 160 ms, 640 ms)	
	Short circuit protection	With short circuit protection	
Repeatability		$\pm 0.1\%$ F.S. ± 1 digit	
Hysteresis	Hysteresis mode	Adjustable (can be set from 0)	
	Window comparator mode	Fixed (3 digits)	
Display		For measured value display: 4-digit, 7-segment indicator, Display color: Orange (Sampling frequency: 4 times/sec) For channel display: 1-digit, 7-segment indicator, Display color: Red	
Display accuracy (Operating temperature at 25°C)		$\pm 0.5\%$ F.S. ± 1 digit	
Indicator light		Red (Lights up when output is turned ON.)	
Auto-shift input		Non-voltage input (Reed or Solid state), Input 10 ms or more, Independently controllable auto-shift function ON/OFF	
Auto-identification function		With auto-identification function ^{Note 2)}	
Environment	Enclosure	Front face: IP65 (when panel-mounted), Others: IP40 ^{Note 3)}	
	Ambient temperature range	Operating: 0 to 50°C, Stored: -10 to 60°C (No freezing or condensation)	
	Ambient humidity range	Operating/Stored: 35 to 85% RH (No condensation)	
Temperature characteristics		$\pm 0.5\%$ F.S. (25°C reference)	
Connection		Power supply/Output connection: 8P connector, Sensor connection: e-con connector	
Material		Housing: PBT; Display: Transparent nylon; Back rubber cover: CR	
Weight		Approx. 60 g (Excluding power supply/output cable)	
Power supply/Output connection cable		Heat resistant heavy-duty cable, 8 cores, $\phi 4.8$, 2 m, Conductor area: 0.15 mm ² , Insulator O.D.: 0.9 mm	
Standards		CE/UKCA marking	

Note 1) If the Vcc and 0 V side of the sensor input connector are short circuited, the inside of the controller will be damaged.

Note 2) Auto-identification function comes with "the PSE53□ series" pressure sensor only. Other SMC series (PSE540, 560, 570) are not equipped with this function.

Note 3) IP40 when using the □48 conversion adapter.

Applicable Pressure Sensor

Applicable sensor					Rated pressure range				Set/Display resolution
PSE53□	PSE54□	PSE55□	PSE56□	PSE57□	-100 kPa	0	100 kPa	1 MPa	
PSE531	PSE541	-	PSE561	-	-101 kPa	0			0.1 kPa
PSE533	PSE543	-	PSE563	PSE573	-101 kPa		101 kPa		0.1 kPa
PSE530	PSE540	-	PSE560	PSE570		0		1 MPa	0.001 MPa
PSE532		-		-		0	101 kPa		0.1 kPa

PSE200 Series

Internal Circuit and Wiring Example

PSE200-(M)□

· NPN open collector 5 outputs + Auto-shift 1 input

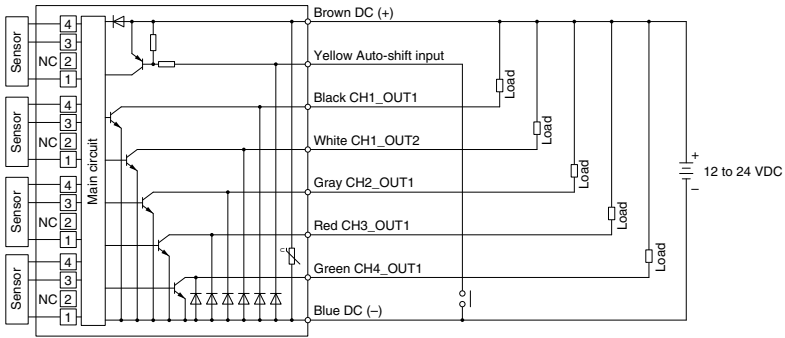

PSE201-(M)□

· PNP open collector 5 outputs + Auto-shift 1 input

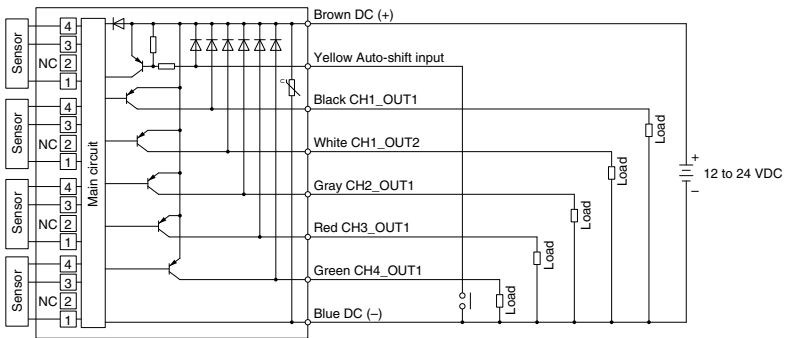

Dimensions

PSE200/201

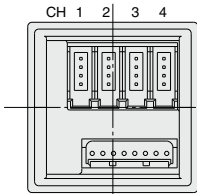
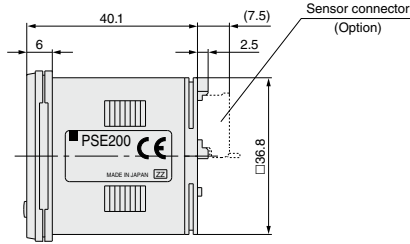
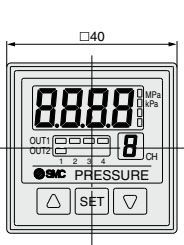

Sensor connector (4P x 4)

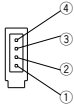

PIN no.	Terminal
①	DC (+)
②	N.C.
③	DC (-)
④	IN (1 to 5 V)

Connector (Option)

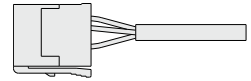

Power supply/Output connector (8P)

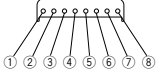

PIN no.	Terminal
①	DC (+)
②	DC (-)
③	CH1_OUT1
④	CH1_OUT2
⑤	CH2_OUT1
⑥	CH3_OUT1
⑦	CH4_OUT1
⑧	Auto-shift input

Power supply/Output connection cable (Accessory)

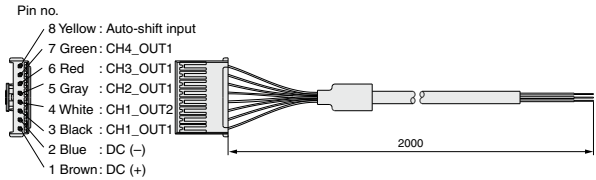

ZSE20
ISE20
ZSE30
ISE30
ZSE40
ISE40
ZSE10
ISE10
ISE70
ZSE80
ISE80
PS
ISA3
ISA2
ISE35
PSE
IS
ISG
ZSM1

PSE200 Series

Dimensions

Front protective cover + Panel mount adapter

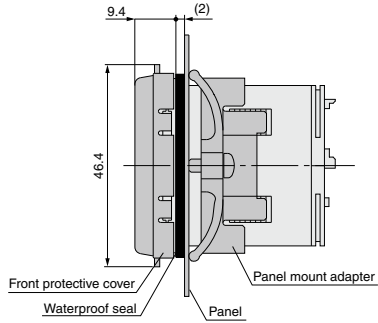
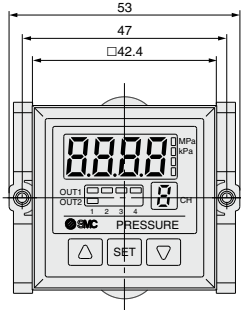

□48 conversion adapter + Panel mount adapter

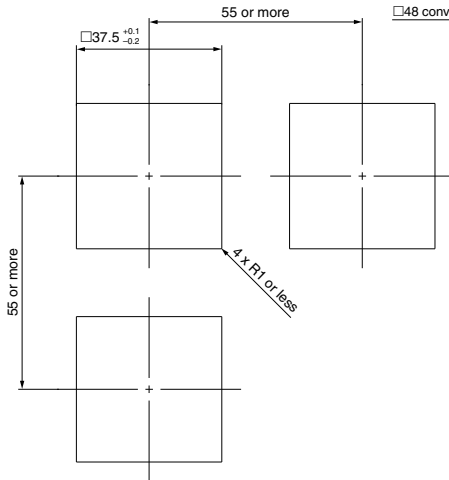
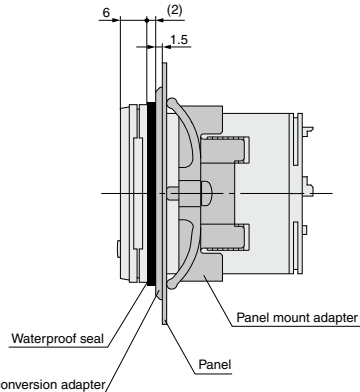
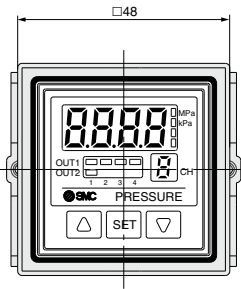

Panel fitting dimensions
Applicable panel thickness: 0.5 to 8 mm



2-Color Display Digital Pressure Sensor Controller

PSE300 Series



Applicable sensors					Rated pressure range					Set/Display resolution
PSE53□	PSE54□	PSE55□	PSE56□	PSE57□	-100 kPa	0	100 kPa	500 kPa	1 MPa	
PSE531	PSE541	—	PSE561	—	-101 kPa	0				0.1 kPa
PSE533	PSE543	—	PSE563	PSE573	-100 kPa		100 kPa			0.2 kPa
PSE530	PSE540	—	PSE560	PSE570		0			1 MPa	0.001 MPa
PSE532	—	—	—	—		0	100 kPa			0.1 kPa
—	—	—	PSE564	PSE574		0		500 kPa		1 kPa
—	—	PSE550	—	—		0	2 kPa			0.01 kPa

2-color display (Red/Green)

Possible to set 4 patterns of display color.

Pattern	ON	OFF
①	Red	Green
②	Green	Red
③	Red	Red
④	Green	Green

Can be mounted in close proximity with each other either horizontally or vertically.

Possible to reduce panel fitting labor.

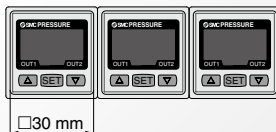

Response time

1 ms

Connector type

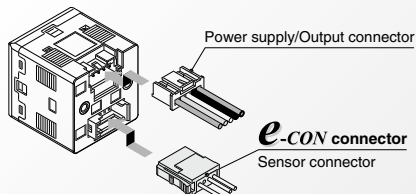

● Functions

- Auto-shift function
- Auto-preset function
- Display calibration function
- Peak/Bottom values holding/display function
- Keylock function
- Zero-clear function
- Error indication function
- Display unit switching function
- Anti-chattering function

DIN rail/Terminal block type

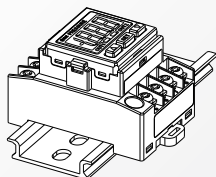

Current input type

Electrical current input (4 to 20 mA DC) is added to the sensor input.

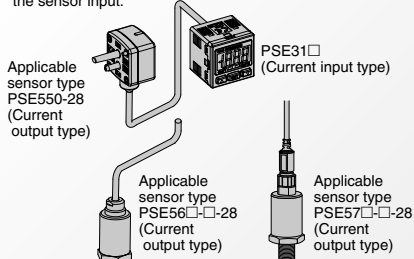

Pressure Sensor Controller

PSE300 Series



How to Order



DIN rail/Terminal block type

PSE3 0 0 T - M

Connector type

PSE3 0 0 - M



Input specifications

0	Voltage input
1	Current input

Input/Output specifications

0	NPN 2 outputs + 1-5 V output
1	NPN 2 outputs + 4-20 mA output
2	NPN 2 outputs + Auto-shift input
3	PNP 2 outputs + 1-5 V output
4	PNP 2 outputs + 4-20 mA output
5	PNP 2 outputs + Auto-shift input

Unit specifications

NII	With display unit switching function ^{Note 1)}
M	Fixed SI unit ^{Note 2)}

Note 1) Under the New Measurement Law, sales of switches with the unit switching function are not allowed for use in Japan.
 Note 2) Fixed unit

For vacuum, low pressure, low differential pressure and compound pressure: kPa
 For positive pressure: MPa (For 1 MPa)
 kPa (For 500 kPa)

Option 1

NII	None
L	Power supply/Output connection cable

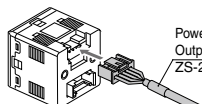

Note) The cable is not attached to the product, but is included with the shipment.

Order DIN rail separately. Refer to page 161.

Option/Part No.

Description	Part no.	Note
Power supply/Output connection cable (2 m)	ZS-28-A	
Bracket	ZS-28-B	With M3 x 5L (2 pcs.)
Sensor connector (1 pc. per set)	ZS-28-C	For the PSE300 series (Excludes the PSE570 series)
	ZS-28-CA-4	For PSE570 series
Panel mount adapter	ZS-27-C	With M3 x 8L (2 pcs.)
Panel mount adapter + Front protective cover	ZS-27-D	With M3 x 8L (2 pcs.)
Front protective cover	ZS-27-01	1 pc.

Option

NII	None
E	Front protective cover

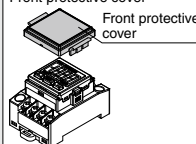

Option 3

NII	None
C	Sensor connector

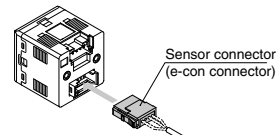

Note) The connector is not attached to the cable, but is included with the shipment.

Note) This connector cannot be used with the PSE570 series.

Option 2

NII	None
A	Bracket
B	Panel mount adapter
D	Panel mount adapter + Front protective cover

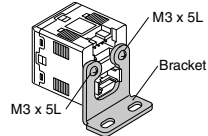
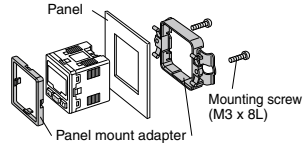
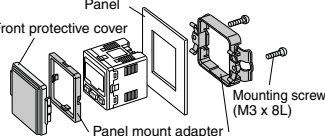
Note) These options are not attached to products, but are included with the shipment.

Specifications

Refer to pages 11 and 12 for Pressure Switch Precautions. For details about the Specific Product Precautions, refer to the Operation Manual on the SMC website, <http://www.smcworld.com> Click [here](#) for details.

Model		PSE3□□					
Applicable pressure sensor		PSE533 PSE543 PSE563 PSE573	PSE531 PSE541 PSE561	PSE532	PSE530 PSE540 PSE560 PSE570	PSE564 PSE574	PSE550
Display/Set pressure (differential pressure) range		-101 to 101 kPa	10 to -101 kPa	-10 to 100 kPa	-0.1 to 1 MPa	-50 to 500 kPa	-0.2 to 2 kPa
Display/Set resolution		0.2 kPa	0.1 kPa	0.1 kPa	0.001 MPa	1 kPa	0.01 kPa
Pressure range ^{Note 1)}	For compound pressure	For vacuum	For low pressure	For positive pressure		For low differential pressure	
Rated pressure (differential pressure) range		-100 to 100 kPa	0 to -101 kPa	0 to 100 kPa	0 to 1 MPa	0 to 500 kPa	0 to 2 kPa
Extension analog output range ^{Note 2)}		—	10.1 to 0 kPa	-10 to 0 kPa	-0.1 to 0 MPa	-50 to 0 kPa	-0.2 to 0 kPa
Power supply voltage	12 to 24 VDC ±10%, Ripple (p-p) 10% or less (with reverse connection protection)						
Current consumption	50 mA or less (Current consumption for sensor is not included.)						
Sensor input	PSE30□: Voltage input 1 to 5 VDC (Input impedance: 1 MΩ) PSE31□: Current input 4 to 20 mA DC (Input impedance: 100 Ω)						
	Number of inputs	1 input					
	Input protection	With excess voltage protection (Up to 26.4 V)					
Hysteresis	Hysteresis mode: Variable, Window comparator mode: Variable						
Switch output	NPN or PNP open collector output: 2 outputs						
	Maximum load current	80 mA					
	Maximum load voltage	30 VDC (at NPN output)					
	Residual voltage	1 V or less (with load current of 80 mA)					
Output protection	With short circuit protection						
Response time	1 ms or less						
Anti-chattering function	Response time settings for anti-chattering function: 20 ms, 160 ms, 640 ms, 1280 ms						
Repeatability	±0.1% F.S.						
Analog output	Voltage output ^{Note 2)}	Output voltage: 1 to 5 V (within rated pressure (differential pressure) range), 0.6 to 1 V (within extension analog output range) Output impedance: Approx. 1 kΩ, Linearity: ±0.2% F.S. (Not including sensor accuracy), Response speed: 150 ms or less					
	Accuracy (To display value) (25°C)	±0.6% F.S.		±1.0% F.S.		±1.5% F.S.	
	Current output ^{Note 2)}	Output current: 4 to 20 mA (within rated pressure (differential pressure) range), 2.4 to 4 mA (within extension analog output range) Maximum load impedance: 300 Ω (at 12 VDC), 600 Ω (at 24 VDC), Minimum load impedance: 50 Ω Linearity: ±0.2% F.S. (Not including sensor accuracy), Response time: 150 ms or less					
	Accuracy (To display value) (25°C)	±1.0% F.S.		±1.5% F.S.		±2.0% F.S.	
Display accuracy (Ambient temperature at 25°C)	±0.5% F.S. ±2 digits	±0.5% F.S. ±1 digit					
Display	3 + 1/2 digit, 7 segment indicator, 2-color display (Red/Green), Sampling frequency: 5 times/sec						
Indicator light	OUT1: Lights up when turned ON (Green), OUT2: Lights up when turned ON (Red)						
Auto-shift input ^{Note 2)}	Non-voltage input (Reed or Solid state), Low level input: 5 ms or more, Low level: 0.4 V or less						
Environment	Enclosure	IP40					
	Operating temperature range	Operating: 0 to 50°C, Stored: -10 to 60°C (No freezing or condensation)					
	Operating humidity range	Operating/Stored: 35 to 85% RH (No condensation)					
	Withstand voltage	1000 VAC for 1 minute between terminals and housing					
	Insulation resistance	50 MΩ or more (500 VDC measured via megohmmeter) between terminals and housing					
Temperature characteristics	±0.5% F.S. (25°C reference)						
Connection	PSE30□□: Power supply/Output connection: 5P connector, Sensor connection: 4P connector PSE31□□: Terminal block						
Material	Front case: PBT, Rear case: PBT (PSE30□□), Modified PPE (PSE31□□)						
Weight	With power supply/Output connection cable	PSE30□□: 85 g					
	Without power supply/Output connection cable	PSE30□□: 30 g, PSE31□□: 50 g					
Power supply/Output connection cable	Oilproof heavy-duty vinyl cable, 5 cores, ø4.1, 2 m, Conductor area: 0.2 mm ² Insulator O.D.: 1.12 mm						
Standards	CE/UKCA marking, UL/CSA (E216656)						

Note 1) Pressure range can be selected during initial setting.

Note 2) Auto-shift function is not available when analog output option is selected.

Also, analog output option is not available when auto-shift function is selected.
Extension analog output is not available for the PSE570 series.

Note 3) The following units can be selected with display unit switching function:

For vacuum & compound pressure: kPa·kgf/cm²·bar·psi·mmHg·in·Hg
For positive pressure & low pressure: MPa·kPa·kgf/cm²·bar·psi
For low differential pressure: kPa·mmH₂O

Analog Output

1 to 5 VDC

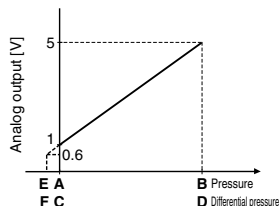

4 to 20 mA DC

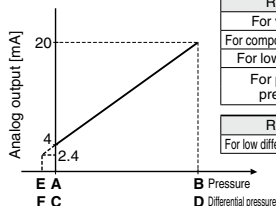

Range	Rated pressure range	A	B	E
For vacuum	0 to -101 kPa	0	-101 kPa	10.1 kPa
For compound pressure	-100 kPa to 100 kPa	-100 kPa	100 kPa	—
For low pressure	0 to 100 kPa	0	100 kPa	-10 kPa
For positive pressure	0 to 1 MPa	0	1 MPa	-0.1 MPa
	0 to 500 kPa	0	500 kPa	-50 kPa

Range	Rated pressure range	C	D	F
For low differential pressure	0 to 2 kPa	0	2 kPa	-0.2 kPa

PSE300 Series

Internal Circuit and Wiring Example

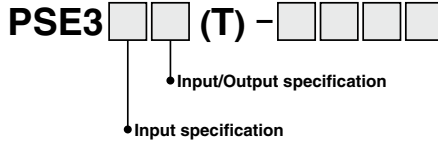

PSE30(T)

NPN (2 outputs) + Analog voltage output

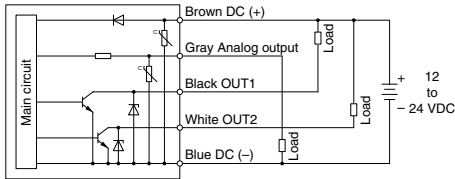

PSE31(T)

NPN (2 outputs) + Analog current output

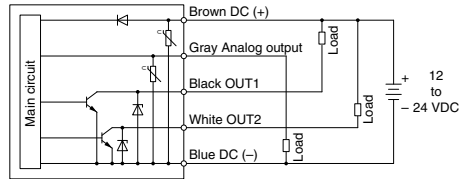

PSE32(T)

NPN (2 outputs) + Auto-shift 1 input

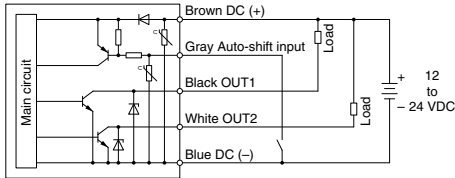

PSE33(T)

PNP (2 outputs) + Analog voltage output

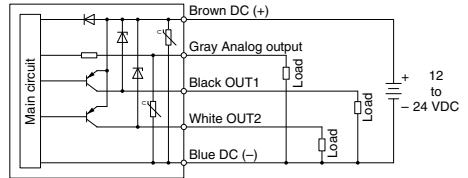

PSE34(T)

PNP (2 outputs) + Analog current output

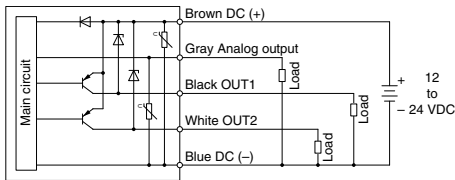

PSE35(T)

PNP (2 outputs) + Auto-shift 1 input

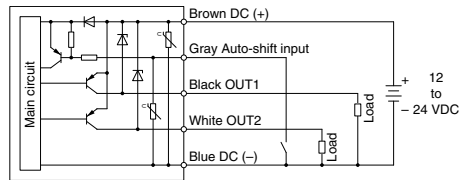

Connector for Sensor Connection

PIN no.	Terminal		
	PSE30 <input type="checkbox"/> (Voltage input)	PSE31 <input type="checkbox"/> (Current input)	
		Pressure sensor 2-wire type	Pressure sensor 3-wire type
1	DC (+) (Brown)	DC (+) (Brown)	DC (+) (Brown)
2	N.C.	N.C.	N.C.
3	DC (-) (Blue)	N.C.	DC (-) (Blue)
4	IN (1 to 5 V) (Black)	IN (4 to 20 mA) (Blue)	IN (4 to 20 mA) (Black)

Note: The colors in () indicate the wire color of the PSE5 series.

Dimensions

PSE3□□

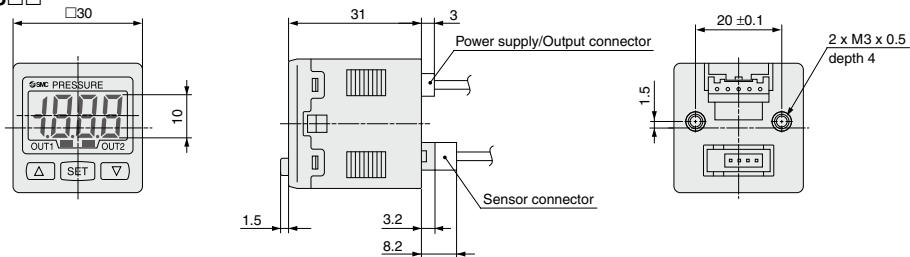

Power supply/Output connection cable (ZS-28-A)

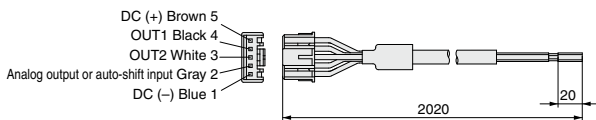

Sensor connector

PIN no.	Terminal	
	PSE30□	PSE31□
1	DC(+)(Brown)	DC(+)(Brown)
2	N.C.	N.C.
3	DC(-)(Blue)	N.C.
4	IN (1 to 5 V) (Black)	IN (4 to 20 mA) (Blue)

Note: The colors in () indicate the wire color of the PSE5□□ series.

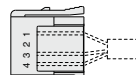

With bracket

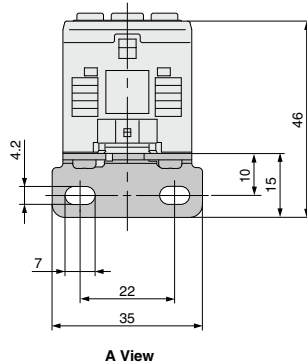
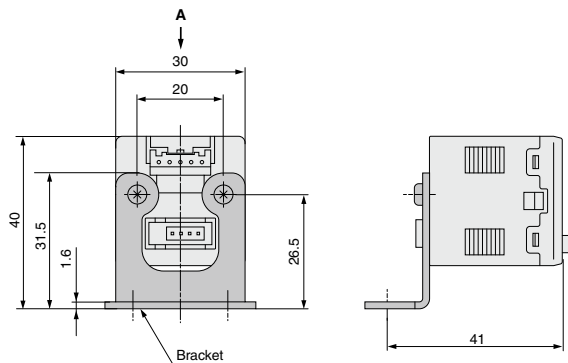

With panel mount adapter

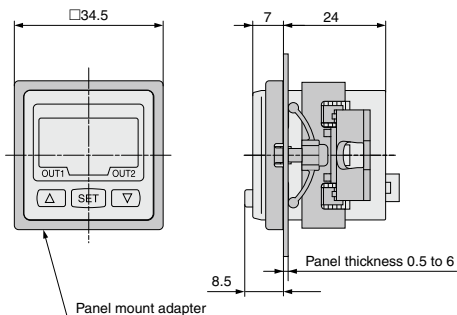

With panel mount adapter + Front protective cover

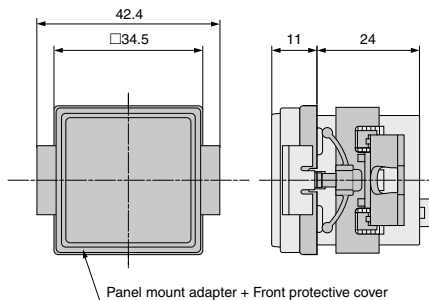

ZSE20
ISE20
ZSE30
ISE30
ZSE40
ISE40
ZSE10
ISE10
ISE70
ZSE80
ISE80
PS
ISA3
ISA2
ISE35
PSE
IS
ISG
ZSM1

PSE300 Series

Dimensions

Panel fitting dimensions

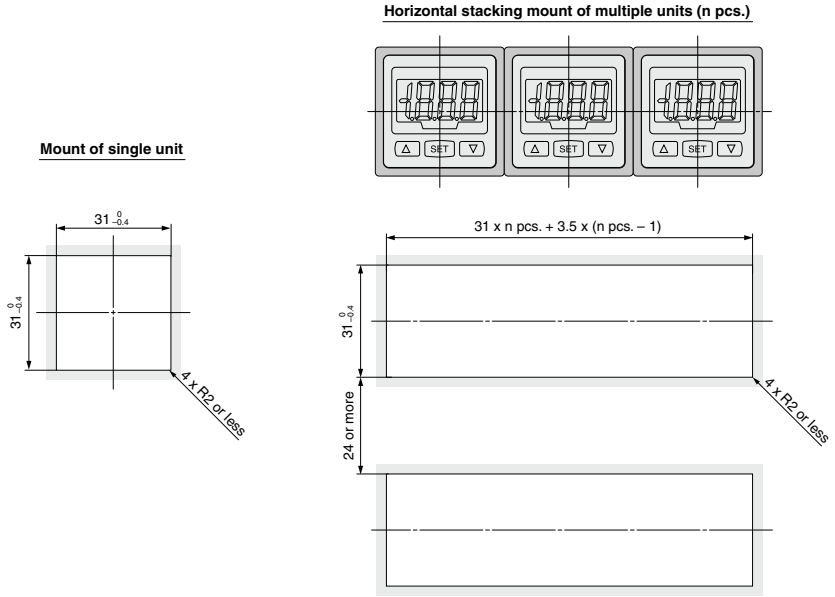

Vertical stacking mount of multiple units (n pcs.)

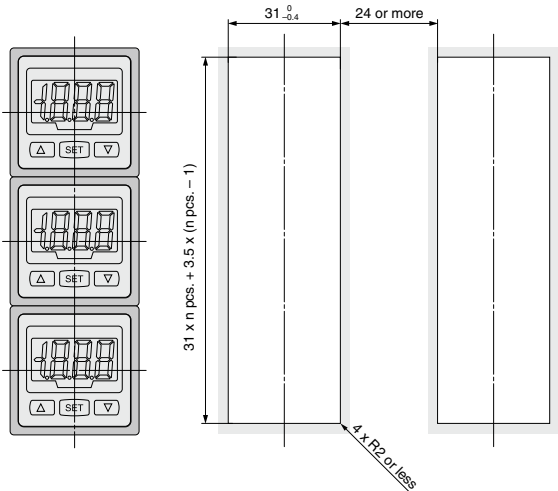

Dimensions

PSE3□□T

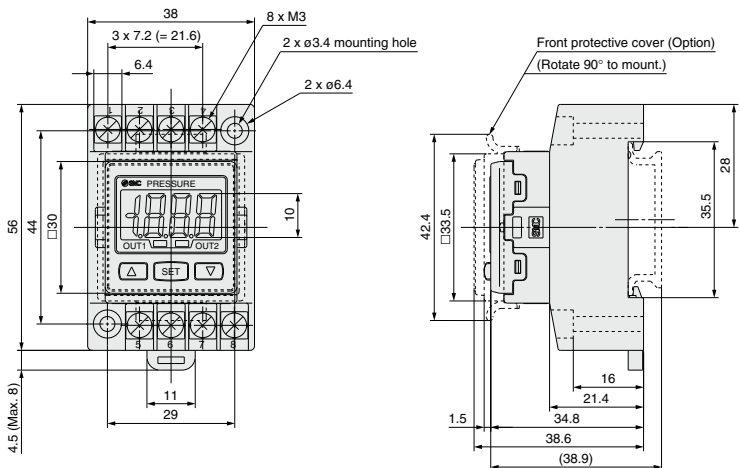

Connections

PSE3□□T

(Voltage input, Current input: Pressure sensor 3-wire type)

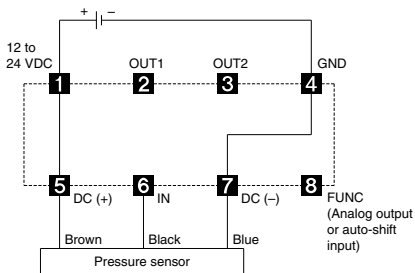

PSE31□T

(Current input: Pressure sensor 2-wire type)

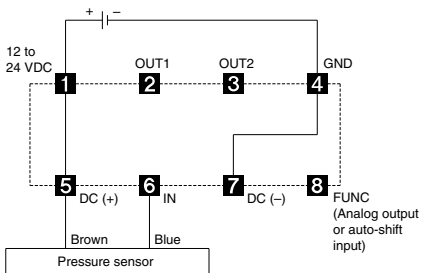

DIN Rail

ISA-5-□

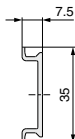
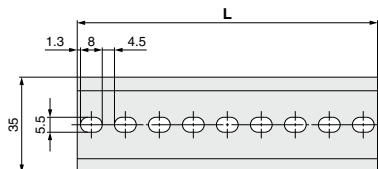

Part no.	L
ISA-5-1	73.0
ISA-5-2	135.5
ISA-5-3	173.0
ISA-5-4	210.5
ISA-5-5	248.0
ISA-5-6	285.5
ISA-5-7	323.0

- ZSE20
- ISE20
- ZSE30
- ISE30
- ZSE40
- ISE40
- ZSE10
- ISE10
- ISE70
- ZSE80
- ISE80
- PS
- ISA3
- ISA2
- ISE35
- PSE
- IS
- ISG
- ZSM1

Function Details

A Auto-shift function

When there are large fluctuations in the supply pressure, the switch may fail to operate correctly. The auto-shift function compensates such supply pressure fluctuations. It measures the (differential) pressure at the time of auto-shift signal input and uses it as the reference (differential) pressure to correct the set value on the switch.

Set value correction by auto-shift function

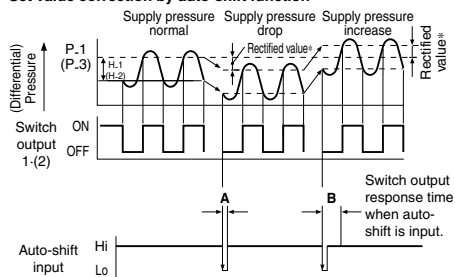

	A Auto-shift input time	B Switch output response time at time of auto-shift input
PSE200	10 ms or more	15 ms or less
PSE300	5 ms or more	10 ms or less

* Rectified value

When the auto-shift is selected, "ooo" will be displayed for approximately 1 second, and the pressure value at that point will be saved as a rectified value "C_5" (for CH1 of PSE200 and PSE300) or "C_3" (for CH2 to 4 for PSE200). Based on the saved rectified values (Note), the set value "P_1" to "P_4" (for PSE200) or "P_1", "H_1", "P_3", "H_2" (for PSE300) will likewise be rectified.

Note) When an output is reversed, "n_1" to "n_4" (for PSE200) or "n_1", "H_1", "n_3", "H_2" (for PSE300) will be rectified.

Settable Range for Auto-Shift Input

PSE200	Set pressure (differential pressure) range	Settable range
Compound pressure	-101.0 to 101.0 kPa	-101.0 to 101.0 kPa
Vacuum	10.0 to -101.0 kPa	101.0 to -101.0 kPa
Low pressure	-10.0 to 101.0 kPa	-100.0 to 101.0 kPa
Positive pressure	-0.1 to 1.000 MPa	-1.000 to 1.000 MPa
Low differential pressure	—	—

PSE300	Set pressure (differential pressure) range	Settable range
Compound pressure	-101.0 to 101.0 kPa	-101.0 to 101.0 kPa
Vacuum	10.0 to -101.0 kPa	101.0 to -101.0 kPa
Low pressure	-10 to 100.0 kPa	-100.0 to 100.0 kPa
Positive pressure	-0.1 to 1.000 MPa	-1.000 to 1.000 MPa
	-50 to 500 kPa	-500 to 500 kPa
Low differential pressure	-0.2 to 2.00 kPa	-2.00 to 2.00 kPa

Auto-shift zero (PSE300 series only)

The basic function of auto-shift zero is the same as the function for auto-shift. Also, it corrects values on the display, based on a pressure value of 0, when the auto-shift is selected.

Auto-shift circuit

PSE□□2

PNP open collector output: 2 outputs

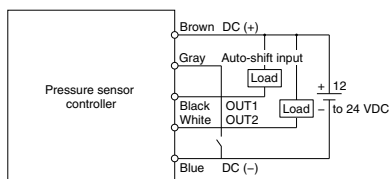

PSE□□5

PNP open collector output: 2 outputs

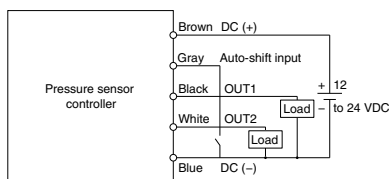

Note) The colors in the circuit diagram indicate the color of the lead wire when it is connected to the power supply/output connection cable (ZS-28-A).

B Auto-preset function

Auto-preset function, when selected in the initial setting, calculates and stores the set-value from the measured (differential) pressure. The optimum set-value is determined automatically by repeating vacuum and break with the target workpiece several times.

Suction Verification

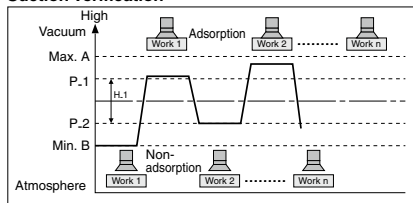

Formula for Obtaining the Set Value

	P_1 or P_3	P_2(H_1) or P_4(H_2)
PSE200		$P_2(P_4)=B+(A-B)/4$
PSE300	$P_1(P_3)=A-(A-B)/4$	$H_1(H_2)=(A-B)/2$

Function Details

C Display calibration function

Fine adjustment of the indicated value of the pressure sensor can be made within the range of $\pm 5\%$ of the read value.
(The scattering of the indicated value can be eliminated.)

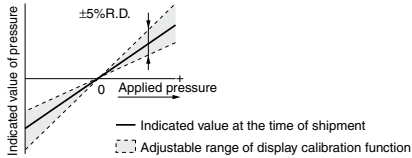

(Note) When the display calibration function is used, the set pressure value may change ± 1 digit.

D Peak/Bottom values holding/display function

This function constantly detects and updates the maximum and minimum values and allows to hold the display value.
For PSE300, when the Δ ∇ are simultaneously pressed for 1 second or longer, while "holding", the hold value will be reset.

E Keylock function

Prevents operation errors such as accidentally changing setting values.

F Zero-clear function

This function clears and resets the zero value on the display of measured (differential) pressure within $\pm 7\%$ F.S. of the factory adjusted value.

G Error indication function

Error name	Error code		Description
	PSE200	PSE300	
Overcurrent error	Er 1	Er 1	Load current of 80 mA or more is applied to the switch output (OUT1).
	Er 2	Er 2	Load current of 80 mA or more is applied to the switch output (OUT2).
Residual pressure error	Er 3	Er 3	Pressure applied during the zero reset operation exceeds $\pm 7\%$ F.S. * After displaying the error code for 3 seconds, the switch automatically returns to the measuring mode. Due to individual product differences, the setting range varies ± 4 digits.
Applied pressure error	---	HHH	Supply pressure exceeds the maximum set (differential) pressure or upper limit of the display pressure.
	----	LLL	A sensor may be disconnected or mis-wired. Or, supply pressure is below the minimum set (differential) pressure or lower limit of the display pressure.
Auto-shift error	/	or	The value measured at the time of auto-shift input is outside the set (differential) pressure range. * After displaying the error code for one second, the switch returns to the measuring mode.
System error	Er 5	Er 4	Internal data error
	Er 6	Er 6	Internal data error
	Er 7	Er 7	Internal data error
	Er 8	Er 8	Internal data error

H Copy function (PSE200 series only)

Information that can be copied includes the following: ① Pressure set values, ② Range settings, ③ Display units, ④ Output modes, ⑤ Response times.

- When CH1 is copied to CH2, CH3, and CH4, information of OUT1 in CH1 will be copied.
- When CH2, CH3, or CH4 is copied to CH1, information of OUT1 in CH2, CH3, or CH4 will be copied only to OUT1 in CH1.

(Note) When the copy function is used, the regulating pressure value of the copied channel may change ± 1 digit.

I Auto-identification function (PSE200 series only)

This function automatically identifies the pressure range of the pressure sensor that is connected to the multi-channel pressure sensor controller, thus eliminating the need of having to reset the range again after replacing the sensor. This function will be activated either when "Aon" is set in the auto-identification mode or when the power is turned back on in that condition. However, this function only works in conjunction with specific pressure sensors (SMC PSE53□ series). When other pressure sensors are used, this function will not work. When using other types of pressure sensors, first set the auto-identification mode to "AoF", and then proceed to setting the range. Turning the power back on while in the "Aon" setting can cause a malfunction.

J Anti-chattering function

A large bore cylinder or ejector consumes a large volume of air in operation and may experience a temporary drop in the supply pressure. This function prevents detection of such temporary drops in the supply pressure as an error.

	Available response time settings
PSE200	20 ms, 160 ms, 640 ms
PSE300	20 ms, 160 ms, 640 ms, 1280 ms

<Principle>

This function averages pressure values measured during the response time set by the user and then compares the average pressure value with the pressure set point value to output the result on the switch.

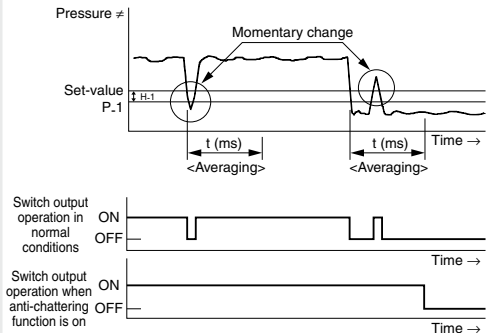

K Channel selection function (PSE200 series only)

Pressure value for the selected channel is displayed.

L Channel scan function (PSE200 series only)

Pressure values for each channel are displayed by turns at 2-second intervals.

ZSE20
ISE20

ZSE30
ISE30

ZSE40
ISE40

ZSE10
ISE10

ISE70

ZSE80
ISE80

PS

ISA3

ISA2

ISE35

PSE

IS

ISG

ZSM1

PSE200/300 Series

Function Details

M Display unit switching function

Display units can be switched with this function. Units that can be displayed vary depending on the range of the pressure sensors connected to the controller.

PSE200

Pressure range	For compound pressure	For vacuum	For low pressure	For positive pressure	
Applicable pressure sensor	PSE533 PSE543 PSE563 PSE573	PSE531 PSE541 PSE561	PSE532	PSE530 PSE540 PSE560 PSE570	
Set pressure (differential pressure) range	-101 to 101 kPa	10 to -101 kPa	-10 to 101 kPa	-0.1 to 1 MPa	
P _R	kPa	0.1	0.1	0.1	—
	MPa	—	—	—	0.001
G _F	kgf/cm ²	0.001	0.001	0.001	0.01
b _R r	bar	0.001	0.001	0.001	0.01
P _S i	psi	0.02	0.01	0.01	0.1
i _n H	inHg	0.1	0.1	—	—
n _n H	mmHg	1	1	—	—

PSE300

Pressure range	For compound pressure	For vacuum	For low pressure	For positive pressure	For low differential pressure		
Applicable pressure sensor	PSE533 PSE543 PSE563 PSE573	PSE531 PSE541 PSE561	PSE532	PSE530 PSE540 PSE560 PSE570	PSE564 PSE574 PSE550		
Set pressure (differential pressure) range	-101 to 101 kPa	10 to -101 kPa	-10 to 100 kPa	-0.1 to 1 MPa	-50 to 500 kPa	-0.2 to 2.00 kPa	
P _R	kPa	0.2	0.1	0.1	—	1	0.01
	MPa	—	—	—	0.001	—	—
G _F	kgf/cm ²	0.002	0.001	0.001	0.01	0.01	—
b _R r	bar	0.002	0.001	0.001	0.01	0.01	—
P _S i	psi	0.05	0.02	0.02	0.2	0.1	—
i _n H	inHg	0.1	0.1	—	—	—	—
n _n H	mmHg	2	1	—	—	—	1 mmH ₂ O

3-Screen Display Sensor Monitor

UK CA RoHS

PSE300AC Series



How to Order

PSE3 **0** **0** OAC - **AB** - **M** - **□**

Input specification

0	Voltage input
1	Current input

Output specification

AB	2 output type (NPN or PNP switching type)
----	---

Option (Power supply/output lead wire)

NH	Straight lead wire
L	Right angle lead wire
N	None

Options/Part Nos.

Description	Part no.	Note
Power supply/output lead wire	ZS-31-B	Straight (5 m) 1 pc.
	ZS-31-C	Right angle (5 m) 1 pc.

* For details on the lead wire with M12 connector and the assembly type connector for connecting to the sensor, refer to page 147.

Unit specification

NH	With unit selection function*1
M	SI unit only*2
P	With unit selection function (Initial value psi)*1

*1 Under the new Measurement Act, sales of switches with the unit selection function have not been allowed for use in Japan.

*2 Fixed unit: Pa, kPa, MPa

For pressure switch precautions and specific product precautions, refer to the "Operation Manual" on the SMC website. Click [here](#) for details.

Specifications

M12 Connector Type

Series		PSE300AC								
Applicable SMC pressure sensor		PSE550	PSE531/PSE541 PSE561	PSE533/PSE543 PSE563/PSE573	PSE532	PSE564 PSE574	PSE530/PSE540 PSE560/PSE570	PSE575	PSE576	PSE577
Rated pressure range		0 to 2 kPa	0 to -101 kPa	-100 to 100 kPa	0 to 100 kPa	0 to 500 kPa	0 to 1 MPa	0 to 2 MPa	0 to 5 MPa	0 to 10 MPa
Display/Set pressure range		-0.2 to 2.1 kPa	10 to -105 kPa	-105 to 105 kPa	-10 to 105 kPa	-50 to 525 kPa	-0.105 to 1.05 MPa	-0.105 to 2.1 MPa	-0.1 to 5.25 MPa	-0.1 to 10.5 MPa
Display/Smallest settable increment		0.001 kPa	0.1 kPa	0.1 kPa	0.1 kPa	1 kPa	0.001 MPa	0.001 MPa	0.01 MPa	0.01 MPa
Electrical	Power supply voltage	12 to 24 VDC (±10%) with 10% voltage ripple or less								
	Current consumption	25 mA or less								
Accuracy	Protection	Reverse connection protection								
	Display accuracy	±0.5% F.S. ±Min. display unit (Ambient temperature at 25°C)								
	Repeatability	±0.1% F.S. ±Min. display unit (Ambient temperature at 25°C)								
	Temperature characteristics	±0.5% F.S. (Ambient temperature of 0 to 50°C, 25°C reference)								
	Output type	Select from NPN or PNP open collector output.								
Switch output	Output mode	Select from hysteresis mode, window comparator mode, error output or switch output OFF.								
	Switch operation	Select from normal output or reverse output.								
	Max. load current	20 mA								
	Max. applied voltage (NPN only)	30 VDC								
	Internal voltage drop (Residual voltage)	1 V or less (with load current of 20 mA)								
	Delay time ^{*1}	1 ms or less (with anti-chattering function: 20, 100, 500, 1000, 2000, 5000 ms)								
	Hysteresis	Variable from 0 ^{*2}								
Sensor input	Protection	Over current protection								
	Input type	Voltage input: 1 to 5 VDC (Input impedance: 1 MΩ), Current input: 4 to 20 mA DC (Input impedance: 51 Ω)								
	Number of inputs	1 input								
	Connection method	M12-4 pin connector								
Display	Protection	Over voltage protection (up to a voltage of 26.4 VDC)								
	Unit ^{*3}	MPa, kPa, Pa, kgf/cm ² , bar, mbar, psi, inHg, mmHg, mmHzO								
	Display type	LCD								
	Number of screens	3-screen display (Main screen, Sub screen x 2)								
	Display color	1) Main screen: Red/Green, 2) Sub screen: Orange								
Digital filter ^{*4}	Number of display digits	1) Main screen: 4-digit (7-segment), 2) Sub screen: 4-digit (Upper 1-digit 11-segment, 7-segment for other)								
	Indicator light	Lights up when switch output is turned ON. OUT1/OUT2: Orange								
Environment	Enclosure	IP65								
	Withstand voltage	1000 VAC for 1 minute between terminals and housing								
	Insulation resistance	50 MΩ or more (500 VDC measured via megohmmeter) between terminals and housing								
	Operating temperature range	Operating: 0 to 50°C, Stored: -10 to 60°C (No freezing or condensation)								
Standards		Operating/Stored: 35 to 85% RH (No condensation)								
Weight		CE/UKCA marking 55.4 g (without power supply or output lead wires)								

*1 Value without digital filter (at 0 ms)

*2 If the applied pressure fluctuates around the set value, the hysteresis must be set to a value more than the amount of fluctuation, or chattering will occur.

*3 This setting is only available for models with the unit selection function. Only MPa, kPa or Pa is available for models without this function.

*4 The response time indicates when the set value is 90% in relation to the step input.

Internal Circuits and Wiring Examples

Setting of NPN open collector 2 outputs: Pressure sensor 3-wire type

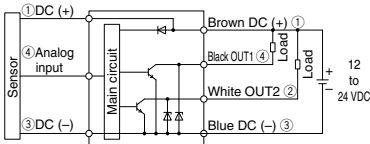

Setting of PNP open collector 2 outputs: Pressure sensor 3-wire type

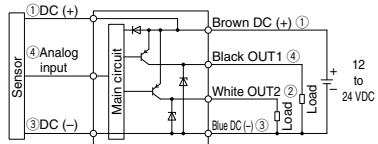

Setting of NPN open collector 2 outputs: Pressure sensor 2-wire type

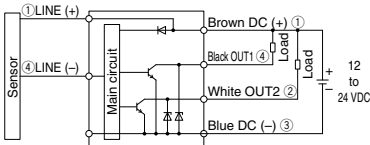

Setting of PNP open collector 2 outputs: Pressure sensor 2-wire type

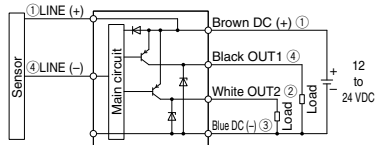

- * The output type can be changed in the function selection mode.
- * Numbers in the figures show the connector pin layout.

Dimensions

Power supply/output connector pin no.

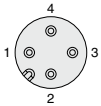

Pin no.	Description
1	DC (+)
2	OUT2
3	DC (-)
4	OUT1

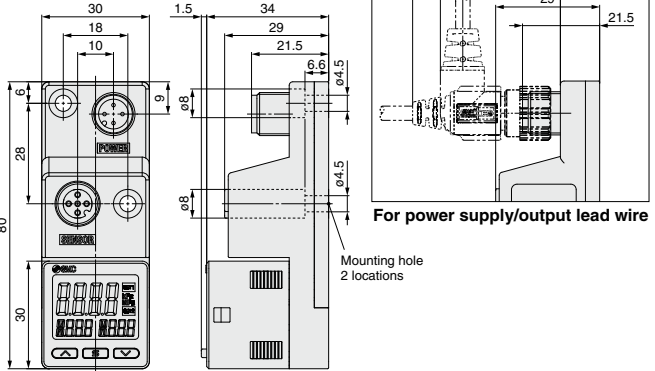

For power supply/output lead wire

Sensor connector pin no.

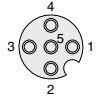

Pin no.	Description
1	DC (+)
2	N.C.
3	DC (-)
4	Sensor input (1 to 5 V, 4 to 20 mA)
5	N.C.

Power supply/output lead wire
ZS-31-B

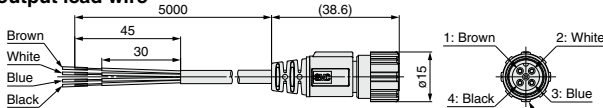

ZS-31-C

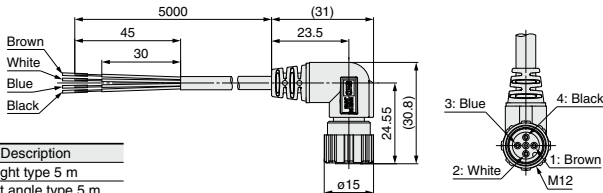

Pin no.	Lead wire color	Description
1	Brown	DC (+)
2	White	OUT2
3	Blue	DC (-)
4	Black	OUT1

Part no.	Description
ZS-31-B	Straight type 5 m
ZS-31-C	Right angle type 5 m

ZSE20
ISE20
ZSE30
ISE30
ZSE40
ISE40
ZSE10
ISE10
ISE70
ZSE80
ISE80
PS
ISA3
ISA2
ISE35
PSE
IS
ISG
ZSM1

PSE300AC Series

Function Details

A Auto-preset function (F4)

Auto-preset function, when selected in the initial setting, calculates and stores the set value from the measured pressure. For example, if this function is used for suction verification, the optimum set value is determined automatically by repeating vacuum and break with the target workpiece several times.

Suction Verification

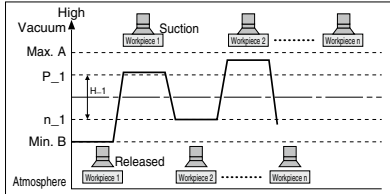

Formula for Obtaining the Set Value

P_1 or P_2	H_1 or H_2
$P_1 (P_2) = A - (A-B)/4$	$H_1 (H_2) = (A-B)/2 $
$n_1 (n_2) = B + (A-B)/4$	

B Display value fine adjustment function (F6)

Fine adjustment of the indicated value of the pressure sensor can be made within the range of $\pm 5\%$ of the read value. (The scattering of the indicated value can be eliminated.)

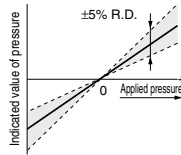

— Indicated value at the time of shipment
 - - - Adjustable range of display value fine adjustment function

Note) When the display value fine adjustment function is used, the set pressure value may change ± 1 digit.

C Peak/Bottom value indication function

This function constantly detects and updates the maximum (minimum) pressure when the power is supplied, and allows to hold the maximum (minimum) pressure value.

The held value is maintained even if the power supply is cut. When the buttons are simultaneously pressed for 1 second or longer, while "holding", the held value will be reset.

D Keylock function

Prevents operation errors such as accidentally changing setting values.

E Zero-clear function

This function clears and resets the zero value on the display of measured pressure.

The indicated value can be adjusted within $\pm 7\%$ F.S. of the pressure when ex-factory. ($\pm 3.5\%$ F.S. for compound pressure)

F Error indication function

This function is to display error location and content when a problem or error has occurred.

Error name	Error code	Description	Action
Over current error		Load current of 20 mA or more is applied to the switch output.	Turn the power off and remove the cause of the over current. Then supply the power again.
Residual pressure error		During zero-clear operation, pressure over $\pm 7\%$ F.S. ($\pm 3.5\%$ F.S. for compound pressure) is present. Note that the mode is returned to measurement mode automatically 1 second later. The zero clear range varies by $\pm 1\%$ F.S. due to variation between individual products.	Perform zero-clear operation again after restoring the applied pressure to an atmospheric pressure condition.
Applied pressure error		Supply pressure exceeds the maximum set pressure.	Reset applied pressure to a level within the set pressure range.
		Supply pressure is below the minimum set pressure.	
System error	 	Internal data error	Turn off the power supply and then turn on it again. If the failure cannot be solved, please contact SMC for investigation.

If the error cannot be reset after the above measures are taken, or errors other than above are displayed, please contact SMC.

Function Details

G Anti-chattering function (Simple setting mode or F1)

A large bore cylinder or ejector consumes a large volume of air in operation and may experience a temporary drop in the supply pressure. This function prevents detection of such temporary drops in the supply pressure as an error by changing the delay time setting.

Available delay time settings
1 ms or less, 20 ms, 100 ms, 500 ms, 1000 ms, 2000 ms, 5000 ms

<Principle>

This function averages pressure values measured during the response time set by the user and then compares the average pressure value with the pressure set point value to output the result on the switch.

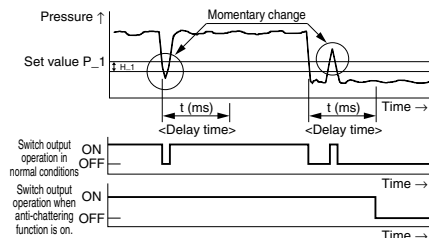

H Unit selection function (F0)

Display units can be switched with this function.

Smallest settable increment	Display unit	Rated pressure range	MPa	kPa	Pa	kgf/cm ²	bar	mbar	psi	inHg	mmHg	mmH ₂ O
			MPa*1	kPa	Pa	kgf/cm ²	bar	mbar	psi	inHg	mmHg	mmH ₂ O
Applicable SMC pressure sensor	PSE550	0 to 2 kPa		0.001	1			0.01	0.001			0.1
	PSE531	0 to -101 kPa	0.001	0.1		0.001	0.001		0.01	0.1	1	
	PSE541											
	PSE561											
	PSE533	-100 to 100 kPa	0.001	0.1		0.001	0.001		0.02	0.1	1	
	PSE543											
	PSE563											
	PSE573											
	PSE532	0 to 100 kPa	0.001	0.1		0.001	0.001		0.01			
	PSE564	0 to 500 kPa	0.001	1		0.01	0.01		0.1			
PSE574												
PSE530	0 to 1 MPa	0.001	1		0.01	0.01		0.1				
PSE540												
PSE560												
PSE570												
PSE575	0 to 2 MPa	0.001	1		0.01	0.01		0.2				
PSE576	0 to 5 MPa	0.01			0.1	0.1		1				
PSE577	0 to 10 MPa	0.01			0.1	0.1		1				

*1 The PSE5□1 (vacuum pressure), PSE5□2 (low pressure), and PSE5□3 (compound pressure) will have different setting and display resolution when the unit is set to MPa.

I Power saving mode (F80)

Power saving mode can be selected.

It shifts to the power saving mode without button operation for 30 seconds.

It is set to the normal mode (Power saving mode is OFF.) when ex-factory.

(During power saving mode, [ECo] will flash in the sub screen and the operation light is ON (only when the switch is ON).)

J Setting of secret code (F81)

Users can select whether a secret code must be entered to release key lock.

At the time of shipment from the factory, it is set such that the secret code is not required.

ZSE20
ISE20
ZSE30
ISE30
ZSE40
ISE40
ZSE10
ISE10
ISE70
ZSE80
ISE80
PS
ISA3
ISA2
ISE35
PSE
IS
ISG
ZSM1

Options / Connection Examples

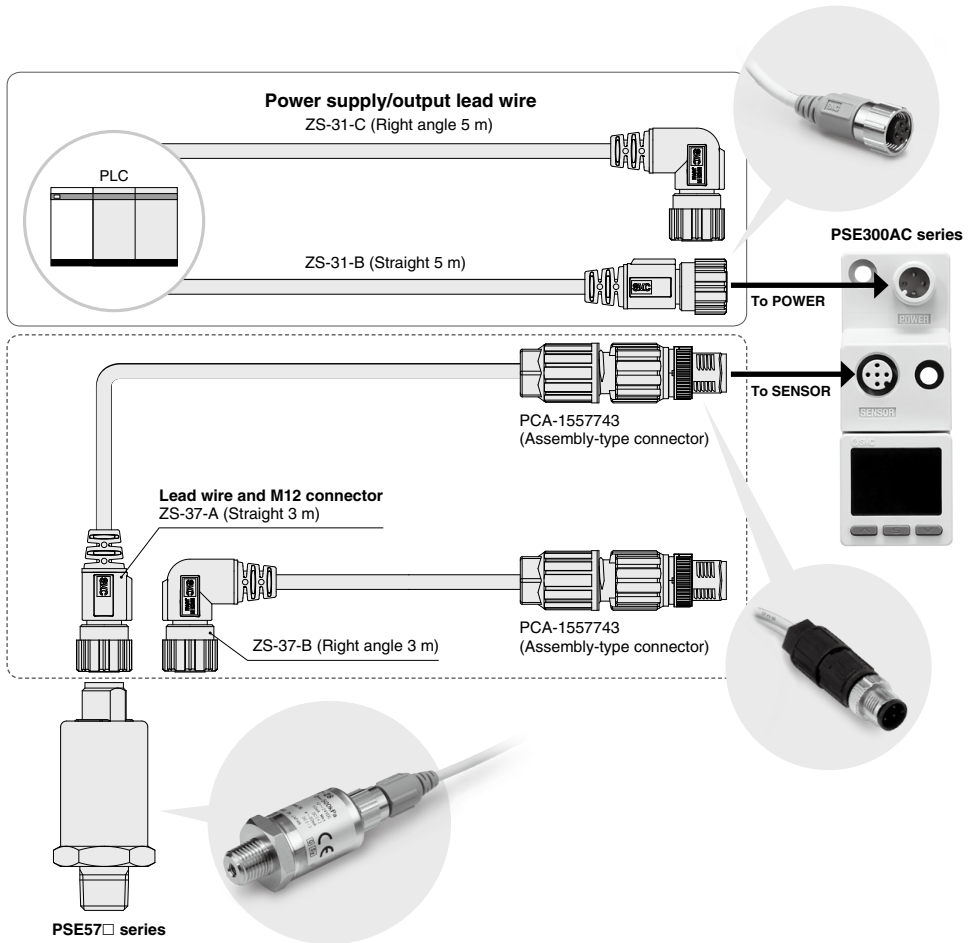

Lead wire and M12 connector + Assembly-type connector

Set part no.

ZS-37-A-X448	Straight 3 m	One lead wire with M12 connector and one assembly type connector are shipped together. (but not assembled)
ZS-37-B-X449	Right angle 3 m	