



ORIGINAL INSTRUCTIONS

Instruction Manual

2-in-1 Auto switch and Setup tool D-MH2**(V)* and D-MH2E* series

IO-Link

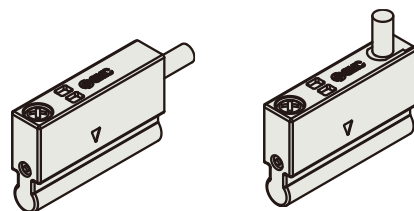

The intended use of the auto switch is to detect and control the position of an actuator using magnetic detection.

1 Safety Instructions

These safety instructions are intended to prevent hazardous situations and/or equipment damage. These instructions indicate the level of potential hazard with the labels of "Caution," "Warning" or "Danger."

They are all important notes for safety and must be followed in addition to International Standards (ISO/IEC¹⁾, and other safety regulations.

¹⁾ ISO 4414: Pneumatic fluid power — General rules and safety requirements for systems and their components.

ISO 4413: Hydraulic fluid power — General rules and safety requirements for systems and their components.

IEC 60204-1: Safety of machinery - Electrical equipment of machines. Part 1: General requirements.

ISO 10218-1: Robots and robotic devices - Safety requirements for industrial robots - Part 1: Robots.

- Refer to the product catalogue, Operation Manual and Handling Precautions for SMC Products for additional information.
- Keep this manual in a safe place for future reference.

	Danger	Danger indicates a hazard with a high level of risk which, if not avoided, will result in death or serious injury.
	Warning	Warning indicates a hazard with a medium level of risk which, if not avoided, could result in death or serious injury.
	Caution	Caution indicates a hazard with a low level of risk which, if not avoided, could result in minor or moderate injury.

Warning

- Always ensure compliance with relevant safety laws and standards.**

All work must be carried out in a safe manner by a qualified person in compliance with applicable national regulations.

- This product is class A equipment intended for use in an industrial environment. There may be potential difficulties in ensuring electromagnetic compatibility in other environments due to conducted or radiated disturbances.

- Refer to the operation manual on the SMC website (URL: <https://www.smcworld.com>) for more Safety Instructions.

- Special products (-X) might have specifications which are different to those shown in the specifications section. Contact SMC for specific drawings.

2 Specifications

- The 2-in-1 auto switch outputs process data of -1000 to 1000 in response to the magnetic force of the magnet inside the cylinder / actuator. By mounting the 2-in-1 auto switch on the actuator and reading the process data value, it is possible to detect the position of the magnet.
- The 2-in-1 auto switch can be configured either using the Setup tool or using IO-LINK communication to set the outputs required.

2 Specifications (continued)

2.1 2-in-1 Auto Switch specifications

Model	D-MH2**(V)*
Power supply voltage	18 to 30 VDC
Current consumption	25 mA max.
Internal voltage drop	0.5 V max.
Current leakage	0.5 mA max.
Maximum Load current	40 mA (SW1, SW2 individually)
Output specification	NPN or PNP (2 outputs)
Circuit protection	Over current protection
Output repeatability	±10 (at 25°C) *1
Output temperature characteristics	±40 (at 25°C) *2
Operating time	5 ms max.
Electrical entry method	Grommet
Impact resistance	1000 m/s ²
Insulation resistance	50 MΩ or more at 500 VDC mega
Withstand voltage	1000 VAC for 1 min. (between case and cable)
Ambient temperature	-10 to 60 °C
Enclosure protection	IP67 (IEC 60529)
Standards	CE/UKCA marked

*1: Single switch unit output characteristics. When the mounting orientation is uniform and there is no magnetic body or magnetic field disturbance in the surroundings.

Excluding a deformation of the workpiece or looseness of the actuator.

*2: Single switch unit output characteristics. The effect of fluctuations in the magnetic force of the magnet itself is excluded.

Note: Do not apply a ferromagnetic field which exceeds 200 [mT] to the auto switch. Otherwise, it may no longer operate normally.

2.2 IO-Link specifications

Version	V1.1	
Communication speed	COM2 (38.4kbps)	
Process data size	Input: 4byte, Output: 0byte	
Minimum cycle time	3.2ms	
Vendor ID	131	
Device ID	D-MH2C***	675 (2 set points)
	D-MH2D***	676 (3 set points)

2.3 Setup tool specifications

Model	D-MH2E*	
Applicable sensor	D-MH2**(V)*	
Power supply rating ^{2,3}	Mobile battery with 5 VDC 2 A min.	
Current consumption	2 A max.	
Process data display range	-1050 to 1050	
Process data setting range	-1050 to 1050	
Connector method	Sensor input: 5-pin connector Power supply: USB type C connector	
Display	Number of displays	3 (1 main display and 2 sub displays)
	LCD Display colour	Main display: red or green; Sub display: orange
Environment	Protection	When connecting the connector for sensor connection and the connector for power supply IP40
	Withstand voltage	1000 VAC for 1 minute between terminals and housing
	Insulation resistance	50 MΩ or more between terminals and housing (with 500 VDC megger)
	Ambient Temperature range	Operation: 0 to 45 °C, Storage: -10 to 60 °C (no condensation or freezing)
Ambient Humidity range	Operation and Storage: 35 to 85% RH (no condensation)	
Standards	CE/UKCA marked WEEE	

2 Specifications (continued)

*1: The Setup tool should be connected to a mobile battery with 5 VDC and 2 A output minimum.

Check the specifications of the mobile battery.

Using it at temperatures above the specifications may cause malfunction, fire or burns.

Follow the instructions and precautions for using the mobile battery.

Depending on the type of mobile battery, the product may not function.

Also, do not connect to any power source other than a mobile battery.

Doing so may cause the product to not function or the power source to malfunction.

*2: The Setup tool may not operate if the mobile battery has a function that automatically turns off the power supply according to the current consumption of the mobile battery.

It is recommended to use a mobile battery that allows this function to be turned on and off.

*3: While SMC strives to improve quality, slight scratches, dirt, uneven display colour and precision that do not affect performance are considered to be good products.

3 Name and function of parts

3.1 2-in-1 auto switch

D-MH2***

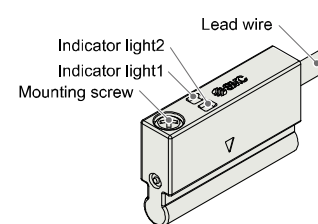

D-MH2**V*

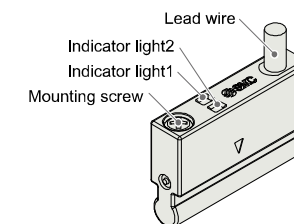

3.2 Setup tool

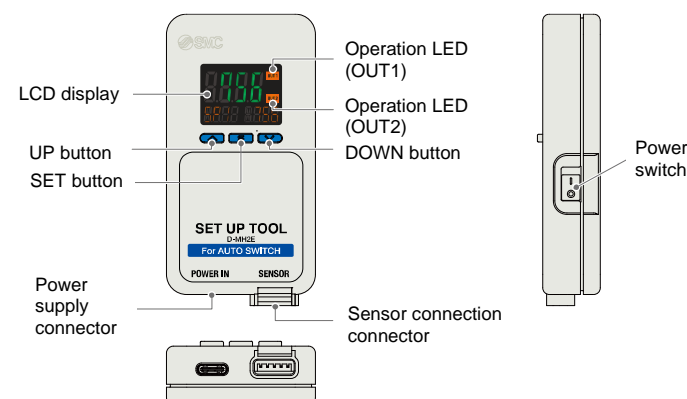

Item	Description
Operation LED	Displays the switch operating condition.
LCD Display	Displays the process data, setting mode status and error code. The upper display is normally displayed in a single green colour and will display in a single red colour if an error occurs. The lower display will display in a single orange colour.
UP button	Press this button to select the mode and increase the ON or OFF set value.
DOWN button	Press this button to select the mode and decrease the ON or OFF set value.
SET button	Press this button to change the mode and to confirm settings.

4 Installation

4.1 Installation

Warning

- Do not install the product unless the safety instructions have been read and understood.

- Confirm the specifications.

Read the specifications carefully and use the product correctly.

If the product is used with excess load applied or beyond the specification range, this may cause the product to be damaged or malfunction. SMC do not guarantee against damage if the product is used outside of the specification range.

- Pay attention to the length of time that the switch is ON at an intermediate stroke position.

When an auto switch is placed at an intermediate stroke position and a load is driven at the time the piston passes, the auto switch will operate, but the operating time will be short if the speed is too fast. As a result, the load may not operate completely.

The maximum detectable piston speed is:

$$V[\text{mm/s}] = \frac{\text{Auto switch operating range [mm]}}{\text{Time load applied [ms]}} \times 1000$$

- Take precautions when multiple cylinders or actuators are used close together.

When multiple auto switches are used in close proximity, magnetic field interference may cause the auto switch to malfunction. Maintain a minimum cylinder / actuator separation of 40 mm. (When the allowable interval is specified for each cylinder series, use the indicated value). Use of a magnetic screen plate (MU-S025) or commercially available magnetic screen tape can reduce the interference of magnetic force.

- Ensure sufficient clearance for maintenance activities.

When designing an application, be sure to allow sufficient clearance for maintenance.

- Do not mount the cylinder or actuator with the auto switch which can be used as a foothold or mechanical support.

- Design the circuit so that reverse current does not flow if a short-circuit occurs or when forced operation is performed.

If a reverse current occurs, this may cause malfunction or damage.

- When multiple auto switches are required.

Detection intervals depend on the auto switch mounting structure and set position, so it may not always be possible to mount the auto switches at the required interval or position.

- Limitations on detectable position

There are positions or surfaces (bottom surface of the foot bracket, etc.) where the auto switch cannot be mounted due to the physical interference depending on the cylinder or actuator mounting status or mounting bracket.

Select an appropriate auto switch setting position where the auto switch does not interfere with the cylinder or actuator mounting bracket (trunnion or reinforcing ring).

- Keep wiring as short as possible.

Be sure to use a wire length of 100 m or less. When the wire length is long, a ferrite core is recommended, attached to both ends of the cable to prevent excessive noise.

- Do not use a load that generates a surge voltage.

If driving a load such as a relay that generates a surge voltage, use a built-in surge protection type device.

- Pay attention to the internal voltage drop of the auto switch. Generally, the internal voltage drop of the solid state auto switch is larger than that of a reed auto switch. When the auto switches ("n" pcs.) are connected in series, the voltage drop is multiplied by "n". Even if the auto switch operates normally, the load may not operate. Also, note that 12 V DC relays are not applicable.

- Pay attention to leakage current.

<2-wire type> When in the OFF state, a current (leakage current) flows to the load to operate the internal circuit.

Load operating current (OFF condition) > Leakage current

If the above criteria is not satisfied, the auto switch will not reset correctly (stays ON).

Use a 3-wire type auto switch if this specification cannot be satisfied. Moreover, leakage current flowing to the load will be "n" times larger when "n" auto switches are connected in parallel.

4 Installation (continued)

- The output operation of the 2-in-1 auto switch and setup tool will not be stable for 600 ms after power-on. For output operation immediately after power-on, and in the case of AND connection, the input device (PLC, relay, etc.) may judge the ON position to be an OFF output, or the OFF position to be an ON output. Set the equipment so that signals are invalid for 50 ms after power-on, and for AND input judgment. Please also set this when using the AHC system (Auto Hand Changing System) MA series.
- The Setup tool may not operate depending on the connected mobile battery. Connect the setup tool to a mobile battery with 5 VDC and output of 2 A minimum. Also, do not connect to a power source other than a mobile battery. It may not operate or the power source may be damaged. The setup tool may not operate if connected to a mobile battery that has a function to automatically turn off the power supply according to the current consumption of the mobile battery. It is recommended to use a mobile battery that allows this function to be turned on and off.

4.2 Environment

Warning

- Do not use in an environment where corrosive gases, oil content, chemicals, salt water or steam are present.
- Do not use in water, or an environment where condensation occurs, or other environments where water is constantly sprayed.
- Do not use in an explosive atmosphere.
- Do not expose to direct sunlight. Use a suitable protective cover.
- Do not install in a location subject to vibration or impact in excess of the product's specifications.
- Do not mount in a location exposed to radiant heat that would result in temperatures in excess of the product specifications.
- Do not mount in a place where static electricity is a problem.
- Do not use in an area where surges are generated.
- Do not use in a welding environment.
- Do not use in an environment with cyclic temperature changes.
- Do not use in an environment subject to radiation stress.

4.3 Mounting precautions

- Do not drop or apply an impact (1000 m/s² max. for solid state auto switches) while handling the auto switch. It may cause the auto switch to be damaged or malfunction.
- Observe the recommended tightening torque for mounting.
- When an auto switch is tightened beyond the range of tightening torque, auto switch mounting screws, auto switch mounting brackets or auto switch may be damaged. Tightening below the range of tightening torque may allow the auto switch to move out of position.
- Do not carry the actuator by holding the lead wire of the auto switch.
- Do not use screws other than the set screws installed in the auto switch for mounting.
- Mount the auto switch at the centre of the operating range. In the case of a 2-colour display auto switch, mount it at the centre of the green LED illuminating range. Adjust the mounting position of the auto switch so that the piston stops at the centre of the operating range. (The mounting position shown in the catalogue indicates the optimum position at the stroke end). If mounted at the end of the operating range (around the borderline of ON and OFF), operation will be unstable depending on the operating environment. Also some cylinders or actuators require individual setting methods for auto switches. If so, mount the auto switch in accordance with the indicated method.
- When adjusting the mounting position check the actual operating conditions. Depending on the installation environment, the cylinder or actuator may not operate even at its correct mounting position. Even if the setting is at midpoint of the stroke, check the operating condition and make the adjustment in the same manner.

4 Installation (continued)

4.4 2-in-1 auto switch Mounting

- When mounting the 2-in-1 auto switch to the cylinder / actuator, the corresponding mounting bracket should be used. The mounting method depends on the cylinder / actuator type and tube inner diameter.
- When mounting a new sensor, check that the cylinder / actuator includes a built-in magnet.
- When tightening the mounting screws, use a cross head screwdriver with #0 blade. Recommended tightening torque is 0.15 to 0.25 N·m.

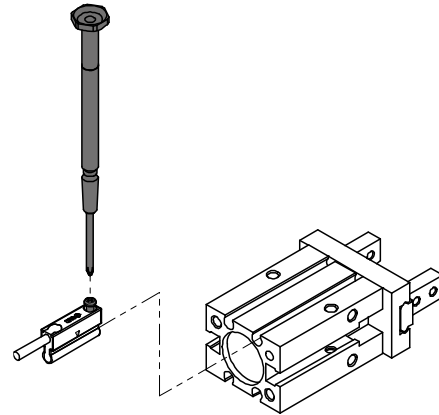

5 Wiring

5.1 Wiring

Caution

- Do not perform auto switch wiring while the power is ON.
- Check the insulation of the wiring.
- Use a separate route for the product wiring and any power or high voltage wiring.
- When using a commercially available switching power supply, be sure

to ground the frame ground (FG) terminal. If a commercially available switch-mode power supply is used, switching noise will be superimposed and the product specifications will not be met. In that case, insert a noise filter such as a line noise filter / ferrite between the switching power supplies or change the switching power supply to a series power supply.

- Avoid repeatedly bending or stressing the lead wires. Broken lead wires will result from repeatedly applying bending stress or tensile forces to the lead wires. Stress and tensile forces applied to the connection between the lead wire and auto switch increases the possibility of disconnection. Prevent the lead wire from moving especially in the area where it connects with the auto switch.
- Always check the load condition (connection and current value) before turning ON the power. <2-wire type> If the auto switch is turned ON without a load connected, an overcurrent will flow and the auto switch will be instantly damaged (short circuit). The same applies if the brown lead wire (+, output) of the 2-wire type is directly connected to the (+) power supply terminal.
- Do not allow a short-circuit of the load. Otherwise, the protection circuit will be activated and the indicator light will flash. The auto switch may be damaged.
- Avoid incorrect wiring.
 - <2-wire type> if the auto switch connections are reversed the auto switch will not be damaged if protected by a protection circuit, but the auto switch will always stay in an ON state. However, it is still necessary to avoid reversed connections, since the auto switch could be damaged by a load short circuit in this condition.
 - <3-wire type> if the auto switch connections are reversed (power supply + and -), the auto switch will be protected by a protection circuit. However, if the power supply line (+) is connected to the blue wire and the power supply line (-) is connected to the black wire, the auto switch will be damaged.

5 Wiring (continued)

5.2 Auto switch Internal circuit and Wiring

• NPN (2 output) specification

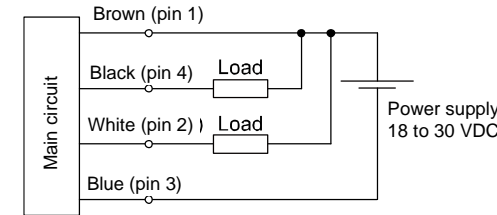

• PNP (2 output) specification

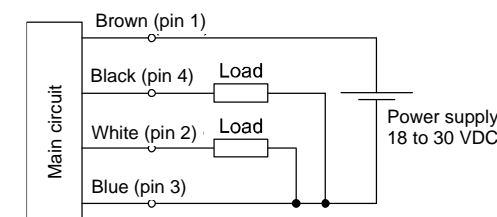

• IO-Link specification

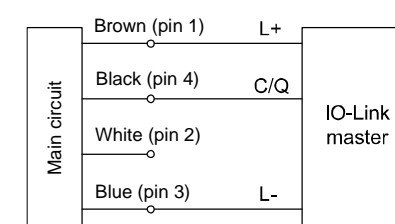

5.2.1 2-in-1 auto switch connector pin assignment

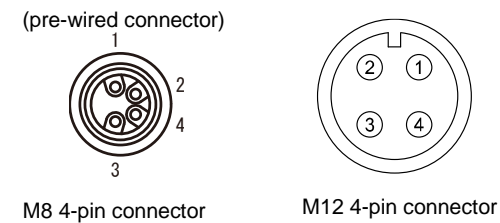

5.3 Setup tool Internal circuit and Wiring

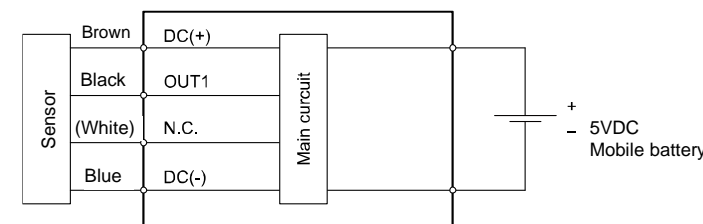

5.4 Connection between 2-in-1 auto switch and Setup tool

- When using a 2-in-1 auto switch with individual wires, fit the setup tool conversion cable connectors (wire clips) to the individual wires of the 2-in-1 auto switch.
- When using a 2-in-1 auto switch with M8 4-pin or M12 4-pin connector, connect the auto switch connector to the Setup tool conversion cable.
- Refer to table below for corresponding setup tool conversion cable.

Setup tool connector pin No.	Setup tool conversion cable			Description
	D-LH03C Connector colours	D-LH03A M8 connector pin No.	D-LH03B M12 connector pin No.	
1	Blue	3	3	DC (-)
2	-	-	-	N.C.
3	-	-	-	N.C.
4	Black	4	4	OUT1
5	RED	1	1	(+)

6 Setup tool settings

Power is supplied

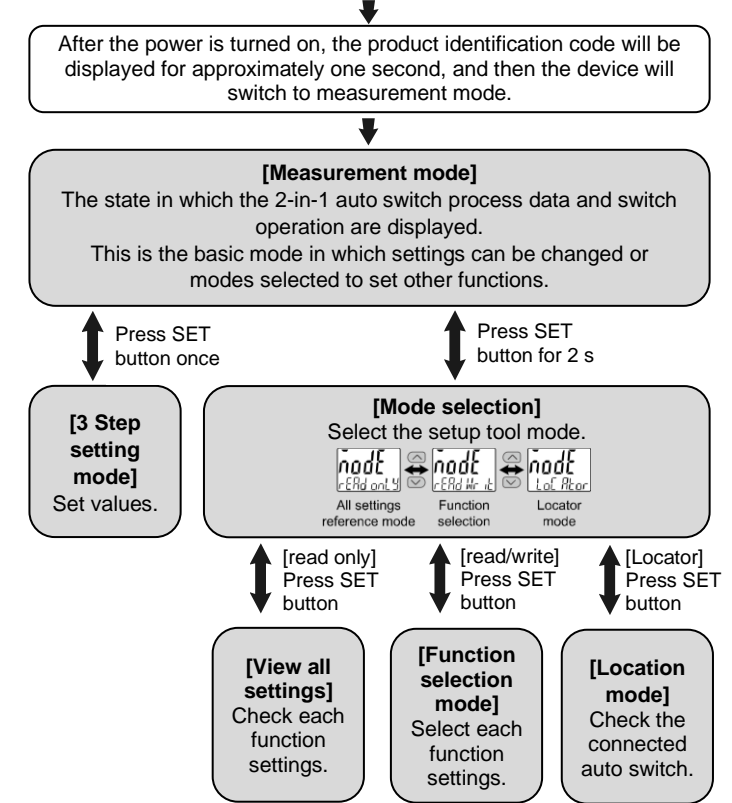

- *: If the button is not pressed for a certain period of time during setting, the display will flash (this is intended to prevent failure to complete the setting).
- *: A setting in 3 step setting mode, simple setting mode, or function selection mode is applied to each of the modes.

7 3 Step Setting mode

In this mode, the set values can be input in just 3 steps. Use this mode if the product is to be used immediately, after changing only the set values (the current process data is displayed on the main display). In 3 step setting mode, the set values (SP1, SP2, SP3) can be changed. *: The setting is possible only in 3 step setting mode.

Select the item (SP1 to SP3) to change on the sub display with the UP or DOWN button. Follow the operation below.

- Press the SET button once when the item to be changed is displayed on the sub display. The set value on the sub display (right) will start flashing. While the set value is flashing, press the UP or DOWN button once. The fourth digit of the set value on the sub-screen (right) will flash.

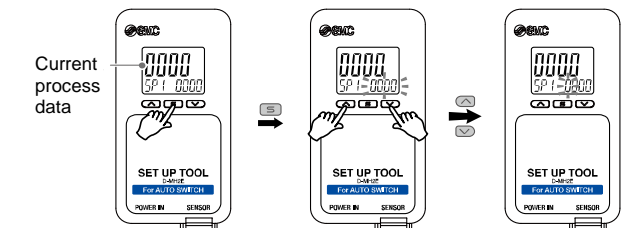

- Press the UP or DOWN button to change the set value. The UP button is to increase and the DOWN button is to decrease. Press the SET button once to complete setting the 4th digit and the 3rd digit of the set value will start flashing. Set the 3rd to 1st digits in the same manner as above. After setting all digits, press the SET button for more than 2 seconds and the set value on the sub screen (right) will start flashing.

7 3 Step setting mode (continued)

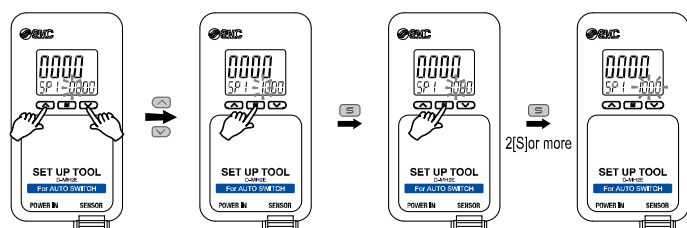

- Snap shot function: Press and hold the UP and DOWN buttons simultaneously for more than one second while the set value is flashing, the set value will be displayed as [- - -] and will automatically become the same as the current process data. Then the set value can be changed for each digit by pressing the UP or DOWN button.
- The set value can be deleted by pressing and holding the SET and DOWN buttons simultaneously for more than one second.

3. Press the SET button to return to measurement mode.

8 All settings reference mode

- When [read only] is displayed during mode selection, press the SET button to display [F 0].
- This is the mode in which [F**] is displayed and the set parameters for each function are displayed. The settings which can be checked are the parameters [F 0], [F 1], [F 2], [F 3], and [F 7].
- Each time the SET button is pressed, the parameters are displayed in order, starting with [F 0 NorP]. Press the SET button after [F 7 Fil] is displayed to display [F 0 NorP] again.
- Press the SET button for more than 2 seconds in the "All settings reference mode" to return to measurement mode.

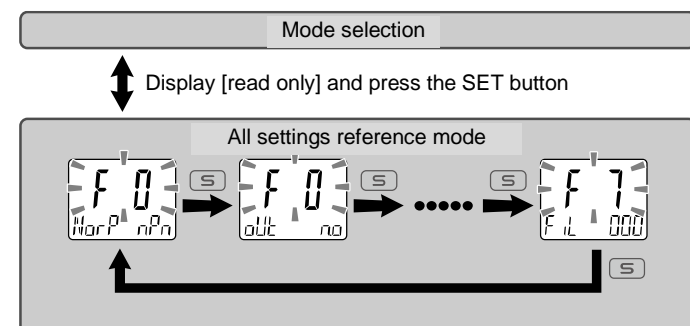

9 Function Selection mode

- When [read write] is displayed in selection mode, press the SET button to display [F 0].
- This is the mode in which [F**] is displayed and the settings of each function can be changed.
- Press the SET button for more than 2 seconds in function selection mode to return to measurement mode.

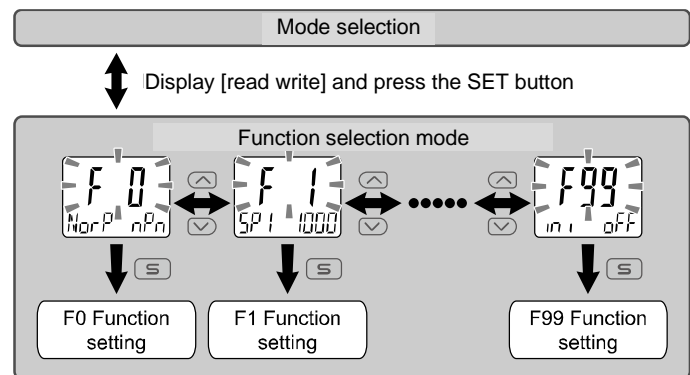

9 Function Selection mode (continued)

9.1 Default function settings

The default settings are as follows. If no problem is caused by this setting, keep the settings. To change a setting, enter function selection mode.

- [F 0] Switch output specification

Item	Default setting
NPN or PNP output	NPN *
N.O. or N.C. output	N.O.
Process data display inversion	OFF

*: Depends on the model number.

- [F 1] Setting of SP1

Item	Description	Default
Output point (SP1)	Set the process data to switch output.	oFF (not set)
ON width (W_1)	Set the ON range to the switch output.	35
Hysteresis (H_1)	Set an appropriate hysteresis to prevent chattering.	10
Delay time (dt)	Select the delay time of the switch output. *: A common setting for SP1 to SP3.	0.00 [s]

- The settings for [F 2] setting of SP2 is exactly the same procedure and default settings as for [F 1].
- The settings for [F 3] setting of SP3 * is exactly the same procedure and default settings as for [F 1].

* This setting is only available in 3 setting mode.

- Other function settings

Item	Default setting
[F 7] Digital filter	0.02 [s]
[F94] Power saving	ON
[F96] Input signal check	-
[F97] Copy function	OFF
[F99] Reset to default settings	OFF

Refer to the operation manual on the SMC website (URL: <https://www.smcworld.com>) for setting these functions.

10 IO-Link Settings

- Communication

This product can check the position measurement value, diagnostic information and switch output status using cyclic data communication via the IO-Link system.

- IODD file

The IODD (I/O Device Description) is a definition file which provides all properties and parameters required for establishing functions and communication of the device.

The IODD includes the main IODD file and a set of image files such as the vendor logo, device picture and device icon.

	Product No.	IODD file *
1	D-MH2C	SMC-D-MH2C-yyyyymmdd-IODD1.1
2	D-MH2D	SMC-D-MH2D-yyyyymmdd-IODD1.1

*: "yyyyymmdd" indicates the file preparation date. yyyy is the year, mm is the month and dd is the date.

The IODD file can be downloaded from the SMC website (<https://www.smcworld.com>).

11 Error indication

Error name	Error indication	Description	Measures
Over current error	Er 1 Er 61	There is an overcurrent in the load current at the switch output.	Turn the power off and remove the cause of the over current. Then supply the power again.
Device connection error	Er 62	The connection between the setup tool and the 2-in-1 auto switch has failed, or a sensor other than the 2-in-1 auto switch is connected.	Check that no sensors other than the 2-in-1 auto switch are connected. Check the sensor connections and wiring.
Display range error	HHH	A magnetic force above the upper limit of the display range is applied to the 2-in-1 auto switch.	Check that no sensors other than the 2-in-1 auto switch are connected. Check the sensor connections and wiring and check that there are no objects around the actuator that generate a large magnetic force.
	LLL	A magnetic force below the lower limit of the display range is applied to the 2-in-1 auto switch.	Check that no sensors other than the 2-in-1 auto switch are connected. Check the sensor connections and wiring and check that there are no objects around the actuator that generate a large magnetic force.
Copy error	--- Copy Err	Copy function was operated incorrectly.	Press the UP and DOWN buttons simultaneously for 1 second or longer to clear the error. Then check the wiring and model before copying again.

If the error cannot be reset after the above measures are taken, or errors other than the above are displayed, please contact SMC.

12 How to Order

Refer to the operation manual or catalogue on the SMC website (URL: <https://www.smcworld.com>) for How to order information.

13 Outline Dimensions

Refer to the operation manual or catalogue on the SMC website (URL: <https://www.smcworld.com>) for Outline Dimensions.

14 Maintenance

14.1 General Maintenance

Caution

- Not following proper maintenance procedures could cause the product to malfunction and lead to equipment damage.
- If handled improperly, compressed air can be dangerous.
- Maintenance of pneumatic systems should be performed only by qualified personnel.
- Before performing maintenance, turn off the power supply and be sure to cut off the supply pressure. Confirm that the air is released to atmosphere.
- After installation and maintenance, apply operating pressure and power to the equipment and perform appropriate functional and leakage tests to make sure the equipment is installed correctly.
- If any electrical connections are disturbed during maintenance, ensure they are reconnected correctly and safety checks are carried out as required to ensure continued compliance with applicable national regulations.
- Do not make any modification to the product.
- Do not disassemble the product, unless required by installation or maintenance instructions.

14.2 Periodical maintenance

Perform the following maintenance periodically to prevent possible danger due to unexpected auto switch malfunction.

- 1) Secure and tighten the auto switch mounting screws.

14 Maintenance (continued)

- If screws have become loose or the mounting position is dislocated, retighten them after readjusting the mounting position.
- 2) Check that there is no damage to lead wires. To prevent faulty insulation, replace auto switches or repair lead wires, etc., if damage is discovered.
 - 3) Check the detection setting position.
 - Red light of 1-colour display auto switch
 - Check that the set position stops at the centre of the operating range (red display area).
 - Check the green light and position of the 2-colour display auto switch.
- Check that the set position stops at the centre of the appropriate operating range (green display area). If the auto switch shows a red light while in the ON/OFF position, the mounting position is not correct. Re-adjust the auto switch to the optimum position at the centre of the operating range. Some cylinders or actuators indicate the individual setting procedures for the auto switch. If so, set the mounting position using the individual setting procedures.
2. Do not use solvents such as benzene, thinners etc. to clean the product. They could damage the surface of the body and erase the markings on the body. For heavy stains, use a cloth lightly dampened with diluted neutral detergent, then wipe up any residue with a dry cloth.
 3. WEEE Directive
This product is classified as waste electrical or electronic equipment according to the WEEE Directive 2012/19/EU and in order to reduce the adverse effects on human health and the environment, should not be disposed of as municipal waste.

How to reset the product after a power loss or when the power has been unexpectedly removed

The settings for the product are retained in memory prior to the power loss or de-energizing of the product. The output condition is also recoverable to that prior to the power loss or de-energizing. However, this may change depending on the operating environment. Therefore, check the safety of the whole installation before

operating the product.

If the installation is using accurate control, wait until the product has warmed up (approximately 10 to 15 minutes) before operation.

15 Limitations of Use

Limited warranty and Disclaimer/Compliance Requirements

Refer to Handling Precautions for SMC Products.

16 Product disposal

This product should not be disposed of as municipal waste. Check your local regulations and guidelines to dispose of this product correctly, in order to reduce the impact on human health and the environment.

17 Contacts

Refer to www.smcworld.com or www.smc.eu for your local distributor / importer.

SMC Corporation

URL : <https://www.smcworld.com> (Global) <https://www.smceu.com> (Europe)
SMC Corporation, 4-14-1, Sotokanda, Chiyoda-ku, Tokyo 101-0021, Japan
Specifications are subject to change without prior notice from the manufacturer.
© SMC Corporation All Rights Reserved.
Template DKP50047-F-085N