

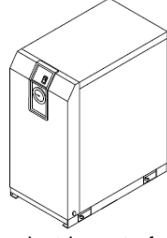

ORIGINAL INSTRUCTIONS

## Instruction Manual Low GWP Refrigerated Air Dryer IDFA3E/4E/6E/8E/11E/15E1-F



The intended use of this product is part of an air preparation line. This product cools down pressurised air and removes condensed water. Pressurised air is reheated and exits the dryer through to the next step of air preparation or application.

### 1 Safety Instructions

These safety instructions are intended to prevent hazardous situations and/or equipment damage. These instructions indicate the level of potential hazard with the labels of "Caution," "Warning" or "Danger." They are all important notes for safety and must be followed in addition to International Standards (ISO/IEC)<sup>1)</sup>, and other safety regulations.  
<sup>1)</sup>ISO 4414: Pneumatic fluid power — General rules and safety requirements for systems and their components.  
 ISO 4413: Hydraulic fluid power — General rules and safety requirements for systems and their components  
 IEC 60204-1: Safety of machinery - Electrical equipment of machines. Part 1: General requirements  
 ISO 10218-1: Robots and robotic devices - Safety requirements for industrial robots - Part 1: Robots

- Refer to product catalogue, Operation Manual and Handling Precautions for SMC Products for additional information.
- Keep this manual in a safe place for future reference.

### 1 Safety Instructions (continued)

<b>Danger</b>	Danger indicates a hazard with a high level of risk which, if not avoided, will result in death or serious injury.
<b>Warning</b>	Warning indicates a hazard with a medium level of risk which, if not avoided, could result in death or serious injury.
<b>Caution</b>	Caution indicates a hazard with a low level of risk which, if not avoided, could result in minor or moderate injury.

#### Warning

- Always ensure compliance with relevant safety laws and standards.
- All work must be carried out in a safe manner by a qualified person in compliance with applicable national regulations.

### 2 Hazard Warnings

- Hazard of Electricity:** Inside of this product, there is a power-supplying section with high voltage separated by the cover panel. Do not operate the product without the cover panel.
- Hazard of Hot Surface:** The product has surfaces that can reach high temperatures during operation. What is more, there is also the danger of burn injury due to remaining heat after the power supply is cut. Therefore, wait until the temperature of hot parts become 50°C and below.
- Hazard of Rotating Fan Motor:** Since this product has parts that rotate during operation, there is the danger of injury resulting from direct contact. The fan and rotor will start/stop automatically. Thus, do not work on them when power is on.
- Hazard of Compressed Air Circuit:** Before replacing or cleaning parts, be sure to bleed compressed air remaining inside of the product until the gauge indicates "0". If there is no relief to the pressure, high pressure can propel objects at high velocity when unscrewing parts and cause injury.
- Hazard Warning Label:** This product uses a A2L (mildly flammable) refrigerant (R1234yf). A hazard warning nameplate (flammable material label) has been added to the product. Follow the contents of this combustible warning label and safety precautions and handling instructions. Refer to Operation Manual '1.26 Location of Hazard Warning Label'.

### 3 Specifications

#### 3.1 Specifications

#### 3.2 IDFA3E-23-F to IDFA15E1-23-F Specifications

Models		IDFA3E-23-F	IDFA4E-23-F	IDFA6E-23-F	IDFA8E-23-F	IDFA11E-23-F	IDFA15E1-23-F		
Operating Range	Fluid	Compressed air							
	Inlet air temperature	°C 5 to 50							
	Inlet air pressure	MPa 0.15 to 1.0 (For option K, L, V: 1.6MPa)							
	Ambient temperature	°C 2 to 45 (Relative humidity 85% or less)							
Rated Conditions	Standard condition (ANR) <sup>1)</sup>	Outlet air pressure dew point	3°C	12	24	36	65	80	120
		Outlet air pressure dew point	7°C	15	31	46	83	101	152
	Air flow capacity m <sup>3</sup> /h	Outlet air pressure dew point	10°C	17	34	50	91	112	168
		Outlet air pressure dew point	3°C	13	25	37	68	83	125
	Compressor inlet condition <sup>2)</sup>	Outlet air pressure dew point	7°C	16	32	48	86	105	158
		Outlet air pressure dew point	10°C	18	35	52	95	116	175
Electrical Specification	Inlet air pressure	MPa 0.7							
	Inlet air temperature	°C 35							
	Ambient temperature	°C 25							
	Maximum air flow capacity	Air flow calculated with correction factors see section 3.4 Coefficient Factors.							
	Power supply <sup>3)</sup>	Single phase 230 VAC 50Hz Allowable voltage fluctuation ±10% <sup>4)</sup>							
	Operating current <sup>5)</sup>	A	1.5	1.5	1.6	1.8	3.1	3.1	
	Power consumption <sup>5)</sup>	W	190	200	210	230	410	420	
Cooling Method	Earth leakage breaker capacity <sup>6)</sup>	A 5							
	Short-Circuit Current Rating (SCCR)	kA 5							
Cooling Method	Air-cooled refrigeration								
	Refrigerant	R1234yf (HFO) GWP0.501							
	Amount of refrigerant	g	150 ± 5	200 ± 5	230 ± 5	270 ± 5	290 ± 5	350 ± 5	
	Port Size		Rc:3/8	Rc:1/2	Rc:1/2	Rc:3/4	Rc:3/4	Rc:1	
	Accessory (Hexagon nipple)		Rc:3/8	Rc:1/2	Rc:1/2	Rc:3/4	Rc:3/4	Rc:1	
	Drain Connection (Outside Diameter of tubing)	mm	10						
	Coating colour		Panel: White 1, Base: Gray 2						
Weight	kg	18	22	23	27	28	46		

#### Notes:

- Air flow rate under the standard condition (ANR) [atmospheric pressure at 20°C, relative humidity at 65%]
- Air flow rate converted by the compressor intake condition [atmospheric pressure at 32°C, relative humidity at 75%].
- The value is that of operation under rated condition.
- Install GFCI breaker that comes with sensitivity of 30mA.
- When short period power shortage (including instantly recovered shortage) is recovered, it may take a longer starting period than usual starting or may not start due to the protective devices.

### 3 Specifications (continued)

#### 3.3 IDFA6E-20-F Specifications

Models		IDFA6E-20-F		
Operating Range	Fluid	Compressed air		
	Inlet air temperature	°C 5 to 50		
	Inlet air pressure	MPa 0.15 to 1.0 (For option K, L, V: 1.6MPa)		
	Ambient temperature	°C 2 to 40 (Relative humidity 85% or less)		
Rated Conditions	Standard condition (ANR) <sup>1)</sup>	Air flow rate, Standard condition	50 Hz	0.75
		Air flow rate, Standard condition	60 Hz	0.82
	Air flow rate, Compressor intake condition	50 Hz	0.8	
		60 Hz	0.87	
	Compressor inlet condition <sup>2)</sup>	Inlet air pressure	MPa 0.7	
		Inlet air temperature	°C 35	
Electrical Specification	Ambient temperature	°C 32		
	Maximum air flow capacity	Air flow calculated with correction factors see section 3.4 Coefficient Factors.		
	Power supply <sup>3)</sup>	Single phase 200/200, 220V AC (50/60 Hz) Allowable voltage fluctuation ±10% <sup>4)</sup>		
	Operating current <sup>5)</sup> (50/60 Hz)	A	1.6/1.6	
	Power consumption <sup>5)</sup> (50/60 Hz)	W	200/230	
	Earth leakage breaker capacity <sup>6)</sup>	A	5	
	Short-Circuit Current Rating (SCCR)	kA	5	
Cooling Method	Air-cooled refrigeration			
	Refrigerant	R1234yf (HFO) GWP0.501		
	Amount of refrigerant	g	230 ± 5	
	Noise Level	dB(A)	70 or less	
	Port Size		Rc:3/4	
	Drain Connection (Outside Diameter (O.D.) of tubing)	mm	10	
	Coating colour		Panel: White 1, Base: Gray 2	
Weight	kg	23		

#### Notes:

- Air flow rate under the standard condition (ANR) [atmospheric pressure at 20°C, relative humidity at 65%]
- Air flow rate converted by the compressor intake condition [atmospheric pressure at 32°C, relative humidity at 75%].
- The value is that of operation under rated condition.
- Install GFCI breaker that comes with sensitivity of 30mA.
- When short period power shortage (including instantly recovered shortage) is recovered, it may take a longer starting period than usual starting or may not start due to the protective devices.

#### 3.4 Coefficient Factors

Inlet Air Temperature (°C)					
5 to 25	30	35	40	45	50
1.30	1.25	1.00	0.83	0.7	0.6

### 3 Specifications (continued)

- Inlet Air Pressure (MPa)

(Models: IDFA3E to 11E-23-F / IDFA6E-20-F)

0.3	0.4	0.5	0.6	0.7	0.8	0.9	1.0	1.2	1.4	1.6
0.80	0.87	0.92	0.96	1.00	1.04	1.07	1.1	1.16	1.21	1.25

(Models: IDFA15E1-23-F)

0.3	0.4	0.5	0.6	0.7	0.8	0.9	1.0	1.2	1.4	1.6
0.72	0.81	0.88	0.95	1.00	1.06	1.11	1.16	1.21	1.25	1.27

- Ambient Temperature (°C)

(Models: IDFA3E to 11E-23-F / IDFA6E-20-F)

2 to 20	25	30	35	40
1.1	1.0	0.91	0.83	0.79

(Models: IDFA15E1-23-F)

2 to 20	25	30	35	40
1.1	1.0	0.97	0.89	0.77

Coefficient Factor Example:

The air flow capacity when the dew point of IDFA3E is set to 10°C under the following conditions:

- Operating conditions:
- Inlet air pressure: 0.7MPa
- Inlet air temp: 40°C
- Ambient temp: 35°C

Corrected Air Flow Capacity:

$$= 17 \text{ m}^3/\text{h(ANR)} \times 1.00 \times 0.83 \times 0.83 = 11.7 \text{ m}^3/\text{h (ANR)}$$

#### 3.5 Production Serial Number Code

#### Warning

Special products (-X) might have specifications different from those shown in this section. Contact SMC for specific drawings.

### 3 Specifications (continued)

The production serial number code printed on the label indicates the month and year of production as per the following table:

Year	2024	2025	2026	...	2029	2030	2031	...				
	C	D	E	...	H	i	J	...				
Month	Jan	Feb	Mar	Apr	May	Jun	Jul	Aug	Sep	Oct	Nov	Dec
	o	P	Q	R	S	T	U	V	W	X	y	Z
	Co	CP	CQ	CR	CS	CT	CU	CV	CW	CX	Cy	CZ
	Do	DP	DQ	DR	DS	DT	DU	DV	DW	DX	Dy	DZ
	Eo	EP	EQ	ER	ES	ET	EU	EV	EW	EX	Ey	EZ
	Ho	HP	HQ	HR	HS	HT	HU	HV	HW	HX	Hy	HZ
	io	iP	iQ	iR	iS	iT	iU	iV	iW	iX	iy	iZ
	Jo	JP	JQ	JR	JS	JT	JU	JV	JW	JX	Jy	JZ
	...	...	...	...	...	...	...	...	...	...	...	...

### 4 Transportation

#### Warning

- When moving the product, lift with care from the base so that the product is not on its side with careful attention to tipping.
- Do not transport the product lying down on its side, or the product will be damaged.
- Do not suspend the product.
- Do not mount the air filter, etc. to the fitting for air inlet and outlet when transporting. If they must be mounted, support the part with a bracket to avoid vibration during transportation.
- Do not install the product unless the safety instructions have been read and understood.
- Transportation, installation, and maintenance including dangerous work must be done by personnel who have require knowledge and experience about the product and system.
- This product is heavy. Follow above cautions to avoid risk during transportation. As the product weighs more than 20kg including package, move the product by a forklift. Moving by forklift should be done by personnel who have the licenses.

### 5 Installation

#### 5.1 Installation

#### Warning

- This product uses a slightly flammable refrigerant. Install in the Floor area of 10 m<sup>2</sup> or more.
- Product installation should be kept from areas with the potential of flammable gas leak. Ignition may occur if leaked gas is collected around the product.
- This product is NOT designed for outside use. Potential electric shock, fire and product damage may occur if exposed to rain, water, and dust.
- The Installer / End User is responsible for carrying out a noise risk assessment on the equipment.

#### Caution

This product is to be installed on a level floor that can withstand the weight of this product. Potential personal injury due to system tipping over may occur if disregarded.

#### 5.2 Environment

#### Warning

Do not use in the following environments, as it may lead to a breakdown. Potential malfunction or damage to the product may occur if these instructions are disregarded.

- Avoid locations where the air dryer will be in direct contact with wind or rain. (Avoid locations where relative humidity is 85% or more)
- Avoid locations where water, water vapor, salt water, or oil may splash on the product.
- Avoid locations where dust or other particles are present.
- Avoid locations where flammable or explosive gases are present.
- Avoid locations where corrosive gases, solvents or combustible gases present.
- Avoid locations which receive direct sunlight or radiated heat.
- Avoid locations where the ambient temperature exceeds the limits as mentioned below. During operation: 2 to 40°C During storage: 0 to 50°C (when there is no drain water inside of the piping)
- Avoid locations where temperature substantially changes.
- Avoid locations where strong magnetic noise occurs. (Avoid locations where strong electric field, strong magnetic fields, or surge voltage occur).
- Avoid locations where static electricity occurs or conditions which make the product discharge static electricity.
- Avoid locations where high frequencies occur.

### 5 Installation (continue)

- Avoid locations where damage is likely to occur due to lightning.
- Avoid installation on machines used for transporting, such as vehicles, ships, etc.
- Avoid locations at altitudes of 2000 meters or higher.
- Avoid locations where strong impacts or vibrations occur.
- Avoid locations where a massive force strong enough to deform the product is applied or the weight from a heavy object is applied.
- Avoid locations with insufficient space for maintenance. Necessary maintenance space Front: 600 mm Back: 600 mm Top: 600 mm Right side: 600 mm Left side: 600 mm
- Avoid locations where the ventilation grille is obstructed.
- Avoid locations where the air dryer will draw in high-temperature air discharged from an air compressor or other dryer.
- Avoid pneumatic circuits where rapid pressure fluctuations or flow speed changes are generated.
- Do not use or store the product in conditions of compressed air or an environment containing substances below. Otherwise, malfunction or parts damage may occur.
- Corrosive gas, organic solvents or chemicals.

#### Caution

- This product uses a slightly flammable refrigerant. Install in the following locations Floor area of 10 m<sup>2</sup> or more.

#### 5.3 Anchorage

- The product should be installed on a vibration-free, stable, horizontal flat surface. Refer to section '7.3 Dimensions' for the dimensions.
- IDFA4E to 15E1 should be bolted by anchor bolts to prevent falling. The anchor bolt sets sold separately as an accessory is (IDF-AB500).

#### 5.4 Piping

#### Caution

- Connection of the inlet and outlet of compressed air should be made removable by using union and so on.
- When an air fitting is connected with the body of the product, hold the pneumatic piping at the body with a pipe wrench and tighten.
- Avoid applying the piping weight directly to the dryer. When parts including air filter are mounted to the fitting of the inlet and outlet for compressed air, support the parts with the bracket to prevent force being applied to the product.
- Be careful not to let the vibration of the air compressor transmit.

## 5 Installation (continued)

- The piping surface temperature will be the same as the inlet temperature of the compressed air. Wrap the piping with insulator when the surface temperature exceeds 50°C.
- When the inlet temperature of the compressed air exceeds 50°C, install the aftercooler after the air compressor or decrease the temperature of the place to install the air compressor to keep the temperature at 50°C or lower.
- When the pressure of the air source fluctuates a lot, install an air tank.
- Before piping, flush the inside of piping to eliminate foreign matter such as particles, seal tape or liquid gasket. Entry of the foreign matter may cause cooling failure or drain discharge failure.
- Use pipes and fittings that have enough endurance against the operating pressure and temperature. And connect it firmly to prevent air leakage.
- Before piping, flush the inside of piping to eliminate foreign matter such as particles, seal tape or liquid gasket. Entry of the foreign matter may cause cooling failure or drain discharge failure.
- Before piping, flush the inside of piping to eliminate foreign matter such as particles, seal tape or liquid gasket. Entry of the foreign matter may cause cooling failure or drain discharge failure.
- Use pipes and fittings that have enough endurance against the operating pressure and temperature. And connect it firmly to prevent air leakage.
- Provide bypass-piping to made it possible to do maintenance without stopping the air compressor.
- Metal flexible tube for air inlet and outlet piping may make noise. Please change the piping to steel tube.
- If rapid pressure fluctuation or flow change occurs, install a filter on the dryer outlet to prevent drain from splashing. λ Depending on the operating conditions, condensation might occur around the outlet piping surface. Wrap insulator around the piping to avoid condensation.

### 5.5 Drain Tube

- A drain tube of 10mm O.D. is included as an accessory. The outlet end of the tube is released to atmosphere and lets the drain flow through the tube. (When customers prepare the drain tube, keep its length at 5m or less and the I.D. at 6.5mm or larger for correct operation of the auto drain)
- Using the pressure of the compressed air, the drain will be discharged periodically. Fix the outlet end of the tube so as not to swing during discharge.
- Prevent the drain tube from having a rise in its piping.
- Do not bend or crush the drain tube. When installing the product, take care not to place the product on the drain tube.

## 5 Installation (continued)

- For piping the drain tube to the back of the dryer, use the holder included as an accessory.

### Warning

- For handling the condensate drain, follow the safety guideline and wear protective goggles, apron and gloves.
- When oil is contained in the condensate drain, dangerous substances may be present. Handle it following the bylaw or regulation of local government.

### 5.6 Electrical Wiring

### Warning

- Only qualified personnel should do electrical wiring work.
- Cut off the power supply for safety before the wiring. Wiring with the product energized is strictly prohibited.
- Use a power supply suitable for the specifications of the product.
- Supply power from a stable place, which is free from the effects of any surge.
- Do not plug too many leads into a single socket. It can cause a fire. - Supply power from a system with an emergency stop equipped.
- To avoid electric shock and burnout of the compressor motor, select the earth leakage breaker with the correct sensitivity of leakage current and load capacity and mount to the supply power side referring to section "3.1 Specifications".
- Install the breaker correctly, so that all power can be shut off and easy access to the operation panel is realized.
- Install a breaker compliant with applicable local safety regulations and standards.
- The equipment should be grounded for safety.
- Add an allowance to the length of the grounding cable so that external force is not applied to it.
- Connect the grounding cable first before connecting other cables and remove it last when removing cables.
- Do not connect the earth to a water pipe, a gas pipe, or lightning rod.
- Do not modify the internal electrical wiring of the product.
- For use in Europe, install a breaker compliant with applicable IEC standards to the power supply of the product.

#### 5.6.1 Power supply cable specification

- Prepare the power supply cables below.
- Approx. 0.2m of cable is necessary for wiring in the product.

## 5 Installation (continued)

Applicable Model	IDFA3E to IDFA15E1-23-F / IDFA6E-20-F
Power supply cable (3-core, including earth)	16AWG (1.25mm <sup>2</sup> )
Cable O.D.	Approx. 8 to 12mm
Power supply length from this product	Less than 30m

### 5.6.2 Power supply

- Connect the power cable and grounding cable to the terminal block. Use round crimp terminal for connection terminal.

Applicable Model	IDFA3E to IDFA15E1-23-F / IDFA6E-20-F
Terminal screws	M3
Crimp terminal	1.25-3 (Terminal width 6.5mm or less)

### 5.6.3 Wiring Procedure

- Remove the front panel.
- Pass the cable through the strain relief to connect to the terminal block. (Refer to the label on the terminal block)
  - M3 Screw tightening torque: 0.5 N·m
  - Do not touch any equipment other than the terminal block during wiring.
- Mount the front panel back.

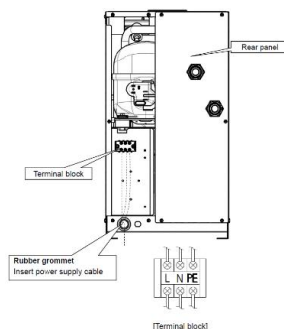

### 5.7 Electric Circuit

For details of the electric circuit, refer to the label on the back of the front panel of this product (see Operation Manual '7.4 Electric circuit').

## 5 Installation (continued)

### 5.8 Reinstallation

If you move the product and reinstall it into another place after some operations (including trial running), all installation instructions in section "5. Installation" should be followed as well as the following instructions.

### Warning

- Only someone who has enough knowledge about the product and incidental devices should reinstall it in another place.
- Cut off the power source before you disassemble the power cable
- Only qualified personnel should do the wiring work.
- Cut off the power supply for safety before the wiring. Wiring with the product energized is strictly prohibited.
- Separate the compressed air source from the product for safety before removing the piping.
- Do not remove any piping when there is remaining compressed air pressure inside of it.
- Remove the seal tape completely after detaching the piping. Remaining tape could cause imperfect cooling or failure by entering the product.

#### 5.8.1 Procedure to release residual compressed air

- Even while the dryer is removed, only open the bypass piping valve when compressed air is needed.
- Close the compressed air inlet and outlet valves.
- Ensure that the ball valve of the auto drain is opened.
- Unscrew the front panel fixing screw (in 2 points) and remove the front panel with upholding it a little.
- Open the residual pressure release cock of auto drain tube and release compressed air pressure left inside of the product.

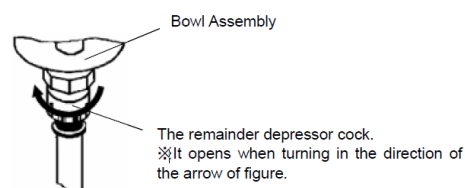

## 6 Operation/Shutdown

### Caution

Only someone who has enough knowledge and experience about the product and incidental devices should operate or shut down the product.

### 6.1 Check points before operation

- Check product is installed on level surface with anchor bolts.
- Do not place heavy objects on product or piping.
- Check if the power cable and ground cable are connected correctly.
- Drain tube should be connected correctly.
- Confirm that the piping to the compressed air is correctly connected. Check that the IN and OUT side of the product and bypass piping valves are completely closed.
- Ensure that the ball valve of the auto drain is opened.

### 6.2 Operation

- Turn on the main power supply breaker. Turn on the switch with lamp.
- The operation lamp turns on. After a moment, the cooling fan will rotate, and hot air will be exhausted from the ventilation outlet.
- Open the IN and OUT side valves slowly. Ensure the bypass valve is completely closed. Confirm that there is no air leakage.
- The fan keeps starting and stopping depending on the compressed air and ambient temperature conditions, but the compressor keeps operating continuously, and the evaporation thermometer stays within the green area. When the refrigerant pressure gauge indicator is in the area higher than the green area, refer to section 8 Troubleshooting.
- After supplying compressed air for a while, the drain will be discharged from the drain tube automatically.
- Continue the operation.

### Caution

- Frequently switching ON and OFF leads to malfunction.
- The auto drain is normally open, and the valve closes when the air pressure is 0.15MPa or more. When the IN-side valve starts to open, air bleeds from the drain outlet until the pressure reaches 0.15MPa. The pressure may not reach 0.15MPa when the air compressor discharge flow rate is small.
- Dehumidified drain may flow into the secondary piping if there is a sudden change of pressure or flow speed. Do not use the product where these conditions are present.

## 6 Operation/Shutdown (continued)

### 6.3 Stop

- Turn off the switch with lamp.
- The lamp turns off and operation stops.

### 6.4 Cautions for re-start

- Allow at least 3 minutes before restarting the product. If the product is restarted within 3 minutes after being stopped, the protection circuit may be activated, and the dryer will not start.
- When operation does not start, restart it referring to the Chapter 6 Troubleshooting.

### 6.5 Check points before restart

When starting operation, check the following points. Immediately stop operation if any abnormality occurs. Turn off the switch with lamp and shut off the breaker of the power supply.

- There should be no leakage of compressed air.
- Compressed air pressure, temperature, flow rate and ambient temperature are within the specifications of the product.
- Confirm that drain comes out of the drain tube. - The evaporation thermometer is in the green area.
- Drain should not be exhausted from the compressed air outlet of the air dryer.
- There should be no abnormality with noise or vibration or odour from the product.

### 6.6 Cautions when the product is shut down for an extended period of time

- When the product is not used for longer than 24 hours, turn off the operation switch or power supply for safety and saving energy. It is recommended to discharge pressure from the compressed air piping.
- The residual drainage in the air dryer may splash over the outlet when the operation is re-started, so it is recommended to install a filter on the outlet of the air dryer.

## 7 Maintenance

### 7.1 General maintenance

### Caution

- Not following proper maintenance procedures could cause the product to malfunction and lead to equipment damage.
- If handled improperly, compressed air can be dangerous.
- Maintenance of pneumatic systems should be performed only by qualified personnel.
- Before performing maintenance, turn off the power supply and be sure to cut off the supply pressure. Confirm that the air is released to atmosphere.
- After installation and maintenance, apply operating pressure and power to the equipment and perform appropriate functional and leakage tests to make sure the equipment is installed correctly.
- If any electrical connections are disturbed during maintenance, ensure they are reconnected correctly, and safety checks are carried out as required to ensure compliance with applicable national regulations.
- Do not make any modification to the product.
- Do not disassemble the product, unless required by installation or maintenance instructions.

### Warning

- Only people who have sufficient knowledge and experience about the product and its incidental devices are allowed to perform maintenance.
- Before maintenance, read and understand the important cautionary notifications in this operation manual.

### Danger

- Cut off the power supply upstream when removing the panel.
- Before replacing or cleaning parts, be sure to bleed compressed air remaining inside of the product until the gauge indicates "0". Do not remove the auto drain case assembly with any air pressure remaining internally. If there is residual pressure in the product, there would be great danger of an unexpected accident, such as shooting out of parts when they are being unscrewed.
- Power supply parts become hot and will be applied with high voltage during operation. Heat may cause burns, or electric shock can result due to high voltage. Even if the switch with lamp is turned off and the operation is stopped, electricity will be applied to the primary line. During the work for primary line, turn off the electrical leakage breaker of the user's equipment.

## 7 Maintenance (continued)

- Even if the device operation stops, there is a danger of burns due to residual heat. Do not start working on the parts inside the product until the temperature has decreased to 50°C or less. Guideline: 10 to 15 minutes
- There is the possibility of contacting the condensate during the auto drain maintenance work. Follow the procedure that you define to keep the worker safe. (Example: Put on protective glasses, apron, and gloves).
- Use an aqueous solution of neutral detergent for cleaning of the auto drain and do not use solvents.
- When removing the panels and auto drain case assembly, wear protective gloves to prevent injuries from sharp edges.

### 7.2 Daily Inspection

Before daily operation, check the following points. When any abnormality is found, stop operation immediately and refer to Troubleshooting in the Operation Manual.

- There should be no leakage of compressed air.
- The lamp is on during operation.
- Confirm that condensate comes out of the drain tube.
- The evaporation thermometer is in the green area.
- There should be no abnormality with noise or vibration from the product.
- There should be no smell or smoke from the product.

### 7.3 Regular Maintenance

#### 7.3.1 Clean the dustproof filter of the ventilation grille

Vacuum or air-blow the filter every month to remove dust and particles of the ventilation grille.

### Caution

Wear protective goggles or mask during air blowing.

#### 7.3.2 Auto drain maintenance

- Remove the dust accumulated in the auto drain element and bowl assembly every month. Use neutral detergent for cleaning.
- When cleaning does not improve the operation, replace the element, and bowl assembly. From the next time, clean them with intervals shorter than a month.

**7 Maintenance (continued)**

**7.4 How to clean and replace the auto drain/strainer**

When carrying out maintenance work on the auto drain and auto drain strainer, please follow the steps:

**7.4.1 Removal of the bowl assembly**

1. Turn off the switch with lamp.
2. Shut off the earth leakage breaker of the power supply or unplug the power plug from the socket.
3. Fully close the inlet and outlet valves. Only open the bypass when compressed air is required during work.
4. Only remove the outer panels when necessary for work.
5. Open the residual pressure release cock at the drain tube connection port to release air and drain fluid left in the product. (Leave the drain tube connected and hold it so that it does not get twisted.)
6. Take care because condensate fluid may spurt out due to residual air pressure in the product.
7. Remove the drain tube.
8. Pull out the tube while pushing up the drain tube release bush.
9. Loosen the vinyl tie fixing the bowl insulation and remove the bowl insulation.
10. Hold the bowl assembly lightly and pull down the lock button with thumb. Then, turn the bowl assembly to the left (or right) to 30° to align the marks. Release your thumb from the lock button and slowly pull down the bowl assembly (vertically) to remove it.

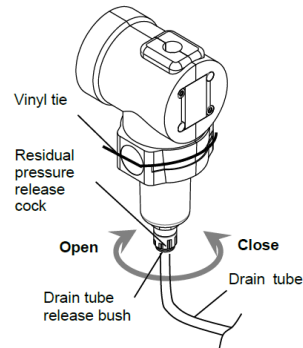

**7 Maintenance (continued)**

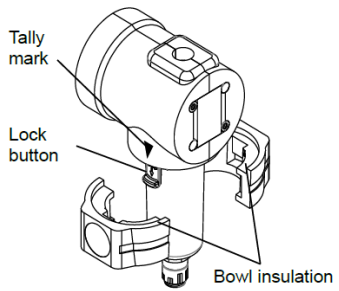

11. Remove the auto drain strainer and clean it. Take care not to cut your hand with the sharp edges of the strainer.
12. Pour solution of neutral detergent into the assembly and shake it well to clean.

**7.4.2 Removal of the bowl assembly**

1. Check the bowl packing for damage such as scratches, twisting or foreign particles attached to it. Then, apply grease thinly and fit it in the groove in the bowl assembly.
2. Fit the auto drain strainer to the case assembly and fit it into the drain separator body. Turn it until the lock button clicks.
3. Turn the bowl assembly gently and check that it does not turn. If it turns, start again from fitting the bowl assembly to the body.

**7 Maintenance (continued)**

4. Attach the bowl insulation to the bowl assembly and fix the bowl assembly with the vinyl tie.

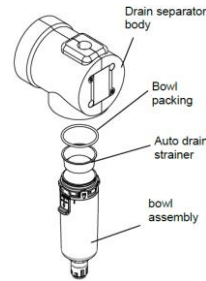

5. Close the residual pressure release cock and mount the drain tube and front panel as they were.
6. When reapplying compressed air to the air dryer, first open the valve on the inlet side slowly. Check for compressed air leakage and if everything is all right, open the valve on the outlet side.
7. If the auto drain strainer or case assembly is damaged or very dirty, replace it with a new one.

**7.5 Periodic Replacement Parts**

**7.5.1 Replacement of consumables listed in the following table is recommended.**

Part	Recommended replacement cycle
Fan motor <sup>*1</sup>	20,000 hours
Pressure switch <sup>*1</sup>	Half a million times
Magnetic <sup>*2</sup>	One million times

- Note:
1. A replacement cycle may vary depending on usage conditions.
  2. Option 'T' (With terminal block for power supply, run, alarm signal) or special order

**7.5.2 Replacement part of Auto drain**

Part No.	Description	QTY.	Applicable Model	Remarks
AD38-A	Bowl	1	IDFA3E/4E-23-F	With bowl packing
AD48-A	assembly	1	IDFA6E to 15E1-23-F	

Note: The drain separator body cannot be replaced.

**7 Maintenance (continued)**

**7.5.3 Replacement parts of the Auto drain strainer and Bowl packing**

Part No.	Description	QTY.	Applicable Model
IDF-S0001	Auto drain strainer	1	IDFA3E/4E-23-F
IDF-S0002		1	IDFA6E to 15E1-23-F
C32FP-260S	Bowl packing	1	IDFA3E/4E-23-F
C42FP-260S		1	IDFA6E to 15E1-23-F

**7.5.4 Bowl insulation**

Part No.	Description	QTY.	Applicable Model	Remarks
IDF-S1932	Bowl	1	IDFA3E/4E-23-F	With bowl packing
IDF-S1933	insulation	1	IDFA6E to 15E1-23-F	

**8 Dimensions**

**8.1 IDFA3E-23-F**

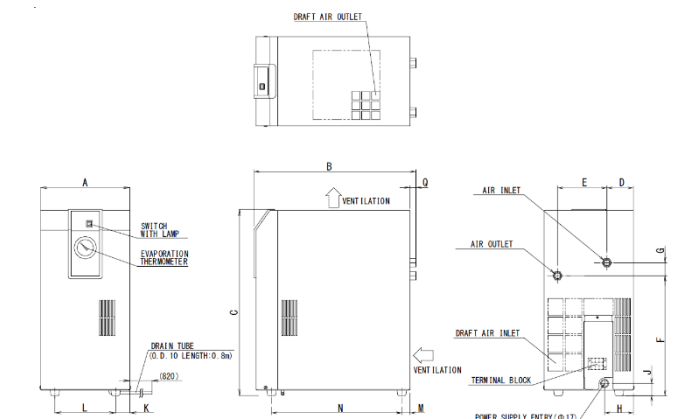

Model	Port Size	A	B	C	D	E	F	G	H	J	K	L	M	N	Q
IDFA3E-23-F	Rc3/8	226	410	473	67	125	304	33	73	31	36	154	21	330	15

**8 Dimensions (continued)**

**8.2 IDFA4E to IDFA11E-23-F and IDFA6E-20-F**

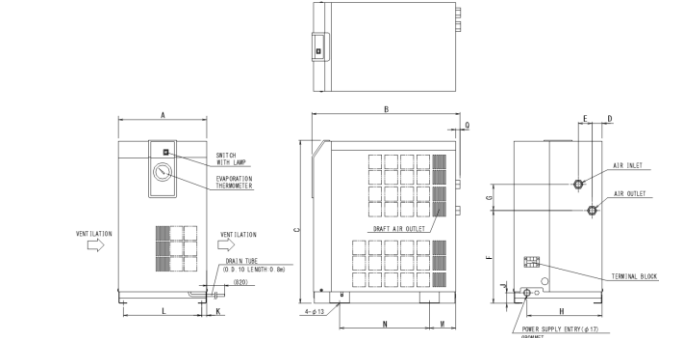

Model	Port Size	A	B	C	D	E	F	G	H	J	K	L	M	N	Q
IDFA4E-23-F	Rc1/2	453	498	42	283								275	13	
IDFA6E-23/20-F	Rc3/4	455	31	80	230	32	15	240	80				300	15	
IDFA8E-23-F		485	568		355										
IDFA11E-23-F															

**8.3 IDFA15E1-23-F**

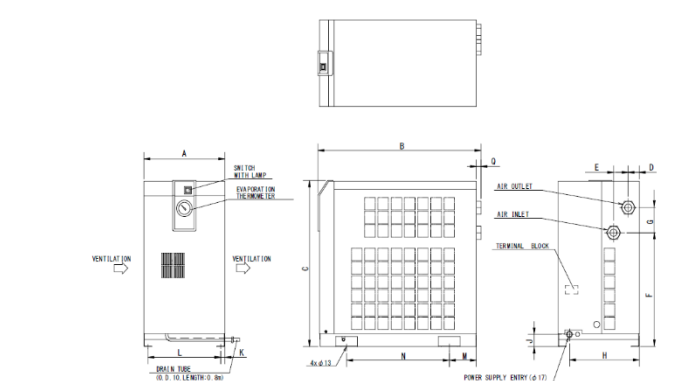

Model	Port Size	A	B	C	D	E	F	G	H	J	K	L	M	N	Q
IDFA15E1-23-F	Rc1	300	603	578	41	54	396	87	258	43	15	270	101	380	16

**9 Troubleshooting**

**Warning**

In the event of an unexpected problem or malfunction, switch off the product and investigate the cause. If the cause of the problem cannot be determined, do not use the product and contact SMC for assistance.

Problem	Possible Causes	Action
Air dryer does not operate, and the running lamp does not turn on, even when the switch is ON.	Power cord is loose or not connected.  The earth leakage breaker is OFF.	Connect the cord correctly.  - Please check the earth leakage breaker capacity. - Turn on the earth leakage breaker. If the breaker keeps turning off, please shut off the power supply and contact our service office. Air dryer insulation failure is possible.
The lamp goes off and the operation stops. (Protection circuit is activated. Reset the protection circuit. See Section 9.1. Reset High Pressure Switch).	Poor ventilation in installation location. Ambient temperature is too high.  Ventilation grille is obstructed by a wall or blocked with dust.  Compressed air temperature is too high.	Keep the ambient temperature low by ventilation.  - Install so that the ventilation grille is 600mm or more away from the wall. - Clean the ventilation grille every month.  - Improve the ventilation condition of the air compressor or lower the ambient temperature to decrease the discharge air temperature of the air compressor. - Install an aftercooler after the air compressor to reduce the temperature.
Large voltage fluctuation.	Restart operation within 3 minutes after operation has stopped.	Install the power transformer or revise the power supply for correct voltage. (Allowable fluctuation of power supply voltage within +/-10% of rated voltage)
Restart operation within 3 minutes after operation has stopped.	Restart operation after 3 minutes.	

**9 Troubleshooting (continued)**

Problem	Possible Causes	Action
Evaporation thermometer indicates higher than green zone.	Poor ventilation in installation location. Ambient temperature is too high.	- Keep the ambient temperature low by ventilation.
	Ventilation grille is obstructed by a wall or blocked with dust.	- Install so that the ventilation grille are 600mm or more away from the wall. - Clean the ventilation grille every month.
Moisture is generated downstream of the compressed air line.	Compressed air temperature is too high.	- Improve the ventilation condition of the air compressor or lower the ambient temperature to decrease the discharge air temperature of the air compressor. - Install an aftercooler after the air compressor to reduce the temperature.
	The bypass valve is open.	- Be sure to use the dryer with the bypass valve fully closed.
The piping converges with piping from a separate air line that does not have an air dryer.	Drain is not discharged from the auto drain.	- Check that the drain tube is not trapped or bent. - Check the auto drain. - Ensure that the ball valve is opened. - Keep the specified operating pressure range.
	Large pressure fluctuation.	- Install an air tank. - Avoid intermittent operation.
	Residual drainage in the air dryer splashes over when the unit is re-started.	- Install a filter on the outlet of the air dryer. - Blow the unit with air to eliminate the residual drain after stopping or re-starting the operation.
	The piping converges with piping from a separate air line that does not have an air dryer.	- Install an air dryer in the line that does not have one. - Do not merge systems with different primary air temperature conditions supplied to the air dryer.

**9 Troubleshooting (continued)**

Problem	Possible Causes	Action	
Large pressure drop.	The valve in the inlet/outlet of dryer piping is not fully opened.	- The valve in the inlet/outlet of the dryer has to be fully opened.	
	The air filter in the compressed air piping is blocked.	- Replace the filter element. - Refer to the operation manual for used equipment.	
Air leakage from the auto drain	The drain does not discharge even if the manual operation of the auto drain is performed.	- Remove the clogging by cleaning the bowl assembly and blowing it with air. Or replace the bowl assembly.	
	Air leaks out from the gap between the bowl and body.	O-ring of the bowl is damaged.	- Replace the bowl O-ring with a new one. When assembling the bowl O-ring, add grease. (Note)
	Air is leaking out of the bowl.	Bowl is damaged.	- Replace the bowl assembly. Or replace with a metal bowl assembly.
	Air leaks out from the gap between the bowl and internal assembly.	Chamber O-ring is damaged.	- Replace the bowl assembly.
	Air leaks out from the gap between the internal assembly and drain cock.	Drain cock O-ring is damaged.	- Replace the bowl assembly.
Drain blockage.	Drainage or air continues blowing out of the drain exhaust.	- When connecting the drain piping, use the piping with I.D of ø 6.5 mm or more and the length should be within 5 m. Riser pipework should be avoided.	
	Drain cock is loosened.	- Tighten the drain cock to "Close" side of the manual knob.	
Drain blockage.	Element is clogged.	- Remove the clogging by cleaning the element and blowing it with air. Or, replace the element.	

Note: Recommend grease: Krytox GPL 207 of Du Pont.

## 9 Troubleshooting

### 9.1 Reset High Pressure Switch

#### Warning

Turn off the switch with lamp and shut off the power supply to the product before removing the panel.

1. Turn off the switch with lamp and shut off the power supply to the product.
2. Remove the front panel. There is a red high pressure switch reset button (see figure below).
3. Press the red reset button.
4. Mount the front panel.
5. Operation restarts when the power is supplied to the product and the switch with lamp is turned on.

[[IDFA6E]]

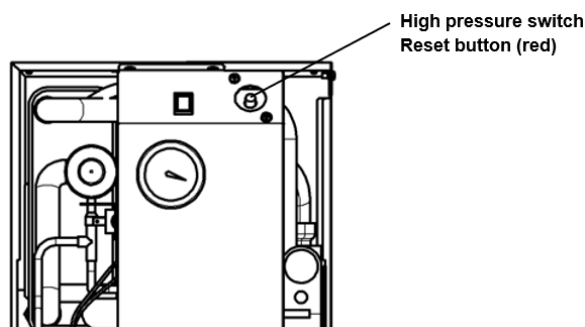

Note:  
Option T does not restart even if it is reset with the power supply ON. Turn on the switch with lamp after turning it OFF.

## 10 Options

### 10.1.1 Option A: Cool Compressed Air Output

Cool outlet air (10°C) can be supplied.

The air flow with this option is smaller than that of the standard air dryer. Air dryer outlet piping may be subject to condensation. Use heat insulating materials to keep the piping warm.

#### Air Flow Capacity

Model <sup>2)</sup>	IDFA3E-23	IDFA4E-23	IDFA6E-23	IDFA8E-23	IDFA11E-23	IDFA6E-20
Air flow rate (ANR) <sup>1)</sup>	8 m <sup>3</sup> /h	23 m <sup>3</sup> /h	29 m <sup>3</sup> /h	32 m <sup>3</sup> /h	39 m <sup>3</sup> /h	0.32/0.375 m <sup>3</sup> /min (50/60 Hz)

Note:

1. The data for ANR is referring to the conditions of 20°C, 1atm. pressure & relative humidity of 65%.
2. The conditions are the same as the ones for standard models other than air flow capacity.

### 10.1.2 Option C: Anti-corrosive Treatment

Special epoxy coating is coated on the copper tube surface to improve the corrosion resistance. Corrosion cannot be completely prevented.

Do not scratch the coated surface of the copper tube when removing the panels for maintenance.

### 10.1.3 Option G: Chinese labels and Operation Manual

Additional, Chinese labels are put on the external panels and Chinese manual is included with supply of the product.

### 10.1.4 Option H: Auto drain bowl with metal bowl (Without level gauge)

See Operation Manual 'Chapter 11 Option H' for details.

## 10 Options (continued)

### 10.1.5 Option K: Auto Drain Bowl Type with Metal Bowl (With level gauge)

The auto drain has a maximum operating pressure of 1.6MPa and uses the metal case with a fluid level gauge. See Operation Manual 'Chapter 12 Option K' for details.

### 10.1.6 Option L: Heavy Duty Auto Drain

Dryer with heavy duty auto drain. The heavy duty auto drain to be assembled by customer.

#### Specifications of heavy duty auto drain ADH4000-04

Part number (service parts)	Heavy duty auto drain	ADH4000-04
	Replacement kit for exhaust valve mechanism	ADH-E400
Auto drain type	Float type	
Auto drain valve type	N.O (Normally Open)	
Maximum specification pressure	1.6 MPa	
Operating pressure range	0.05 - 1.6 MPa	
Maximum condensate discharge	0.024m <sup>3</sup> /h (0.7 MPa, water)	

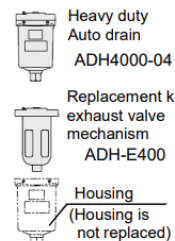

#### 10.1.6.1 Installation of the Heavy Duty Auto Drain

- Hold the hexagonal part (width across flats: 32 only IDFA15E1) at the connection port Rc1/2 of the product with a spanner and screw-in the barrel nipple and elbow in order.
- Screw-in the long nipple and heavy duty auto drain (width across flats of drain inlet port: 30) completely. Mount the heavy duty auto drain vertically while facing the drain port downwards. (Allowable inclination difference in the vertical direction is 5°)
- Hold the hexagon-head part (width across flats: 32 only IDFA15E1) at port Rc1/2 of the air dryer with spanner. Then install nipple, ball valve (width across flats: 25).
  - Put up the seal tape or the sealant to the nipple.
  - Torque R1/2 ,R3/4: 28 to 30N·m

## 10 Options (continued)

- Hold the ball valve with the spanner. Then install a nipple and a Heavy duty auto drain.
- Install with "out port" down in a vertical position. Inclination from the vertical line should be less than 5°.
- Install one-touch fitting (width across flats: 22) to drain port (width across flats: 27) and the drain tube.

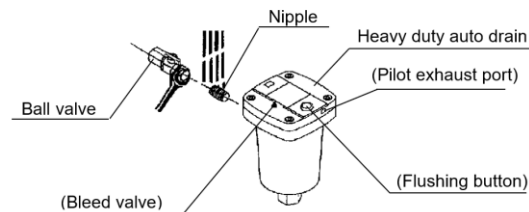

#### 10.1.6.2 Maintenance

1. Check the auto drain condition at least once a day. Press the flush button to clean (flush) the exhaust valve. See Operation Manual 'Chapter 13 Option L' for details.
2. The pilot air of the heavy duty auto drain is exhausted from the position in the drawing. Do not block the exhaust port. Do not obstruct the exhaust port with airborne particles, etc.
3. Before removing the heavy duty auto drain, close the ball valve, and open the bleed valve or press the flush button and confirm that there is no air pressure.

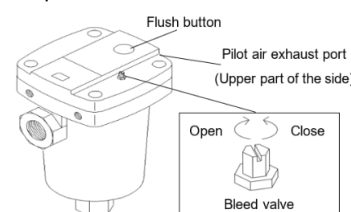

## 10 Options (continued)

### 10.1.7 Option R: Ground Fault Circuit Interrupter (GFCI)

Ground Fault Circuit Interrupter (GFCI), this will shut off the power supply in case the product should have over current or current leakage. Additionally, the power supply should be connected directly to the primary side of the GFCI.

#### 10.1.7.1 Specification of the GFCI

Model Number	GFCI Specification		SCCR [kA]
	Rated current [A]	Current sensitivity [mA]	
IDFA4E/6E/8E/11E-23- <sup>*</sup> FR <sup>*</sup>	5	30	1.5
IDFA6E-20- <sup>*</sup> FR <sup>*</sup>	10	30	2.5

#### 10.1.7.2 How to Connect the Power Supply

Connect the power supply cable in the following procedure.

1. Take off the rear panel.
2. Introduce the cable through the Electrical entry to connect to the GFCI.
3. Connect the power supply cable to the terminal of the GFCI.
4. Put back the rear panel.

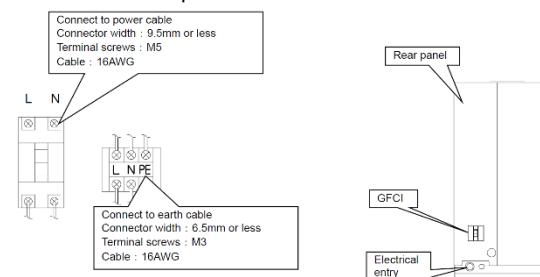

#### 10.1.7.3 Electric Circuit

For details of the electric circuit, refer to the label on the back of the front panel of this product (see Operation Manual '7.4 Electric circuit').

## 10 Options (continued)

### 10.1.8 Option T: Terminal block for the output of the operation, error signals.

#### 10.1.8.1 How to connect the power supply and signal cable

Connect the power cable and signal cable in the following procedures.

1. Take off the rear panel.
2. Insert the power cable prepared by the customer into the power cable inlet (with rubber grommet) and bring the power cable near the terminal block through the base hole.
3. Connect the power cable to the terminal.
4. Insert the signal cable prepared by the customer into the signal cable inlet (with rubber grommet) and bring the signal cable near the terminal block.
5. Connect the signal cable to each terminal.
6. Put back the rear panel.

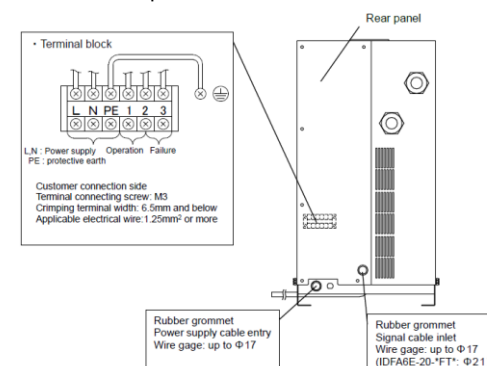

Note: Option 'T' electrical circuit see Operation Manual '15.4 Electric circuit'.

### 10.1.9 Option V: Timer-controlled solenoid valve type auto drain

Drainage is discharge by controlling a solenoid valve with a timer. The timer is set to have 'ON' time for 0.5 seconds and 'OFF' time for 30 seconds as factory default.

See Operation Manual 'Chapter 16 Option V' for details.

## 11 Location of Hazard Warning Labels

### 11.1 IDFA3E-23-F

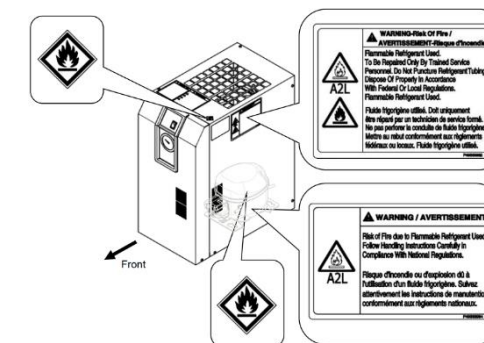

### 11.2 IDFA4E to 11E, 15E1 -23-F

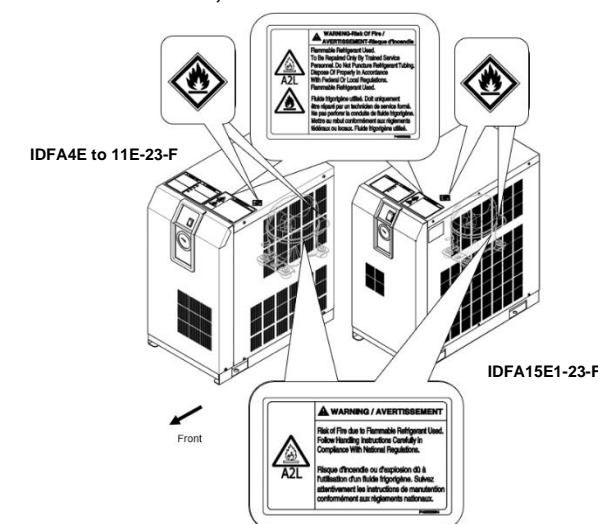

## 12 Limitations of Use

### 12.1 Limited warranty and disclaimer/compliance requirements

Refer to Handling Precautions for SMC Products.

### 13 Product Disposal

This product shall not be disposed of as municipal waste. Check your local regulations and guidelines to dispose this product correctly, in order to reduce the impact on human health and the environment.

### 14 Declaration of Conformity

Below is a sample Declaration of Conformity (DoC) used in this product.

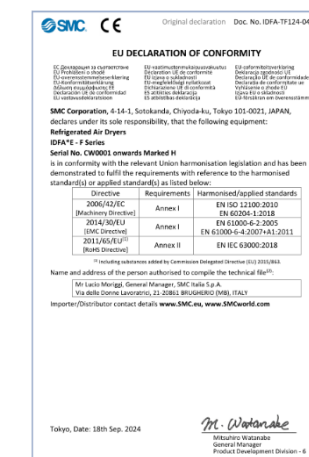

## 15 Contacts

Refer to [www.smcworld.com](http://www.smcworld.com) or [www.smc.eu](http://www.smc.eu) for your local distributor/importer.

## SMC Corporation

URL : <https://www.smcworld.com> (Global) <https://www.smc.eu> (Europe)  
SMC Corporation, 4-14-1, Sotokanda, Chiyoda-ku, Tokyo 101-0021, Japan  
Specifications are subject to change without prior notice from the manufacturer.  
© SMC Corporation All Rights Reserved. Template DKP50047-F-085N