



ORIGINAL INSTRUCTIONS

Instruction Manual

3 Port Solenoid Valve

Series S070

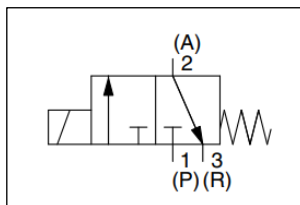
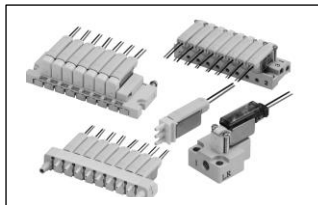

The intended use of this valve is to control the movement of an actuator.

1 Safety Instructions

These safety instructions are intended to prevent hazardous situations and/or equipment damage. These instructions indicate the level of potential hazard with the labels of "Caution," "Warning" or "Danger." They are all important notes for safety and must be followed in addition to International Standards (ISO/IEC^{*)}, and other safety regulations.

^{*)} ISO 4414: Pneumatic fluid power - General rules relating to systems.
ISO 4413: Hydraulic fluid power - General rules relating to systems.
IEC 60204-1: Safety of machinery - Electrical equipment of machines. (Part 1: General requirements)
ISO 10218-1: Robots and robotic devices - Safety requirements for industrial robots - Part 1: Robots.

- Refer to product catalogue, Operation Manual and Handling Precautions for SMC Products for additional information.
- Keep this manual in a safe place for future reference.

Caution	Caution indicates a hazard with a low level of risk which, if not avoided, could result in minor or moderate injury.
Warning	Warning indicates a hazard with a medium level of risk which, if not avoided, could result in death or serious injury.
Danger	Danger indicates a hazard with a high level of risk which, if not avoided, will result in death or serious injury.

Warning

- Always ensure compliance with relevant safety laws and standards.
- All work must be carried out in a safe manner by a qualified person in compliance with applicable national regulations.

Caution

- The product is provided for use in manufacturing industries only. Do not use in residential premises.

2 Specifications

2.1 Valve specifications

Valve construction	Poppet	
Fluid	Air / Low vacuum (1.33 x 10 ² Pa)	
Maximum operating pressure [MPa] ^{Note 1)}	0.35 W / 0.1 W	0.3
	0.5 W	0.5
Proof pressure [MPa]	1	
Ambient and fluid temperature [°C] ^{Note 2)}	-10 to 50 (no freezing)	
Flow rate characteristics	Refer to catalogue	
Response time	Refer to catalogue	
Duty cycle	Contact SMC	
Minimum operating frequency [Hz]	1 cycle / 30 days	
Manual override	None	
Lubrication	Not required	
Impact/Vibration resistance [m/s ²] ^{Note 3)}	0.35 W / 0.5 W	150 / 30
	0.1 W	50 / 10
Enclosure (based on IEC60529)	IP40	
Mounting orientation	Unrestricted	
Weight [g] (valve only)	5	

Table 1.

2 Specifications - continued

Note 1) With the low vacuum specification, the operating pressure range is 1.33 x 10² Pa to the maximum operating pressure.

Note 2) Use dry air to prevent condensation when operating at low temperatures.

Note 3) Impact resistance: No malfunction resulted in an impact test using a drop impact tester. The test was performed one time each in the axial and right angle directions of the main valve and armature, for both energized and de-energized states. (Values quoted are for a new valve).

Vibration resistance: No malfunction resulted in 45 to 2000 Hz, a one-sweep test performed in the axial and right angle directions of the main valve and armature for both energized and de-energized states. (Values quoted are for a new valve).

2.2 Solenoid specifications

Electrical entry	Grommet (G), Plug lead (C)	
Coil rated voltage [VDC]	24, 12, 6, 5, 3	
Allowable voltage fluctuation ^{Note 1)}	±10% of rated voltage	
Coil insulation class	Class B or equivalent	
Power consumption [W]	Standard	0.35
	High voltage	0.5
^{Note 2)}	Normal	0.1
	Holding ^{Note 3)}	0.1
Surge voltage suppressor	0.35 W / 0.5 W	Varistor
	0.1 W	Diode
Indicator light	LED	

Table 2.

Note 1) Care should be taken about the voltage drop when the rated voltage is 6 VDC or less or when the response speed is important.

Note 2) With a light/surge voltage suppressor and power saving circuit, the light consumes a power equivalent to 2 mA.

Note 3) 0.1 W specification is only available with 24 VDC plug lead type.

2.3 Manifold specifications

Refer to catalogue.

2.4 Indicator light

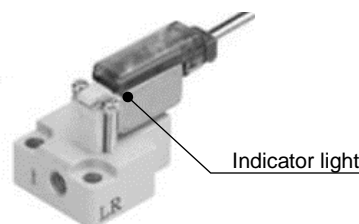

Figure 1. Only for Plug lead (C) type

2.5 Special products

Warning

Special products (-X) might have specifications different from those shown in this section. Contact SMC for specific drawings.

3 Installation

3.1 Installation

Warning

- Do not install the product unless the safety instructions have been read and understood.

3.2 Environment

Warning

- Do not use in an environment where corrosive gases, chemicals, salt water or steam are present.
- Do not use in an explosive atmosphere.
- Do not expose to direct sunlight. Use a suitable protective cover.
- Do not install in a location subject to vibration or impact in excess of the product's specifications.
- Do not mount in a location exposed to radiant heat that would result in temperatures in excess of the product's specifications.

3 Installation - continued

3.3 Piping

Caution

- Before connecting piping make sure to clean up chips, cutting oil, dust etc.
- When installing piping or fittings, ensure sealant material does not enter inside the port. When using seal tape, leave 1 thread exposed on the end of the pipe/fitting.
- Tighten M3 screws 1/4 turn past hand tightness, and M5 screws by 1/6 turn past hand tightness (1/4 turn for miniature fittings) and to the specified tightening torque as per below table.

Connection threads	Proper tightening torque [N·m]
M3	0.4 to 0.5
M5	1 to 1.5

Table 3.

3.3.1 Tubing installation

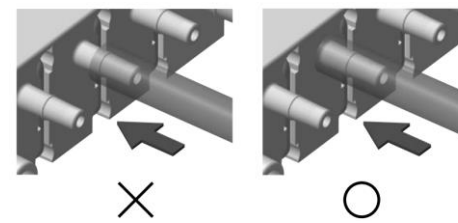

Figure 2.

3.4 Lubrication

Caution

- SMC products have been lubricated for life at manufacture, and do not require lubrication in service.
- If a lubricant is used in the system, refer to catalogue for details.

3.5 Air supply

Warning

- Use clean air. If the compressed air supply includes chemicals, synthetic materials (including organic solvents), salinity, corrosive gas etc., it can lead to damage or malfunction.

Caution

- Install an air filter upstream of the valve. Select an air filter with a filtration size of 5 µm or smaller.

3.6 Mounting

Caution

- Ensure gaskets are in good condition, not deformed and are dust and debris free.
- When mounting valves ensure gaskets are present, aligned and securely in place. After tightening by hand, tighten an additional 1/4 rotation for M3 and 1/6 rotation for M5. Tighten the screws to torque levels as per figure below.
- Refer to catalogue for additional information.

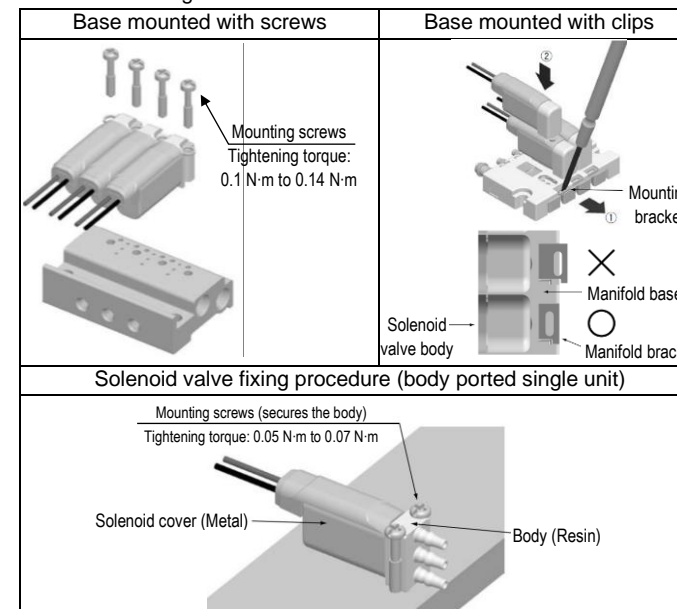

Figure 3.

3 Installation - continued

3.7 Electrical circuits

Caution

Surge suppression should be specified by using the appropriate part number. If a valve type without suppression (Type 'G') is used, suppression must be provided by the host controller as close as possible to the valve.

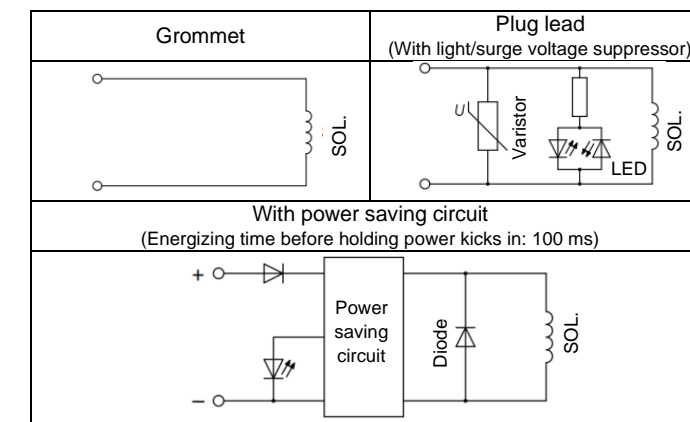

Table 4.

Note) There is no polarity for Grommet type or Plug lead type.

3.8 Residual voltage of the surge voltage suppressor

Caution

- The suppressor arrests the back EMF voltage from the coil to a level in proportion to the rated voltage.
- Ensure the transient voltage is within the specification of the host controller.
- Contact SMC for the varistor residual voltage.
- In the case of a diode, the residual voltage is approximately 1 V.
- Valve response time is dependent on surge suppression method selected.

3.9 Countermeasure for surge voltage

Caution

- At times of sudden interruption of the power supply, the energy stored in a large inductive device may cause non-polar type valves in a de-energized state to switch.
- When installing a breaker circuit to isolate the power, consider a valve with polarity (with polarity protection diode), or install a surge absorption diode across the output of the breaker.

3.10 Extended periods of continuous energization

Warning

If a valve will be continuously energized for an extended period of time, the temperature of the valve will increase due to the heat generated by the coil assembly. This will likely adversely affect the performance of the valve and any nearby peripheral equipment. Therefore, if the valve is to be energized for periods of longer than 30 minutes at a time or if during the hours of operation the energized period per day is longer than the de-energized period, we advise using valves with power saving circuit (type E or F).

3.11 Effect of back pressure when using a manifold

Warning

Use caution when valves are used on a manifold because an actuator may malfunction due to back-pressure.

4 How to Order

Refer to catalogue for 'How to Order'.

5 Outline Dimensions

Refer to catalogue for outline dimensions.

6 Maintenance

6.1 General maintenance

Caution

- Not following proper maintenance procedures could cause the product to malfunction and lead to equipment damage.
- If handled improperly, compressed air can be dangerous.

6 Maintenance - continued

- Maintenance of pneumatic systems should be performed only by qualified personnel.
- Before performing maintenance, turn off the power supply and be sure to cut off the supply pressure. Confirm that the air is released to atmosphere.
- After installation and maintenance, apply operating pressure and power to the equipment and perform appropriate functional and leakage tests to make sure the equipment is installed correctly.
- If any electrical connections are disturbed during maintenance, ensure they are reconnected correctly and safety checks are carried out as required to ensure continued compliance with applicable national regulations.
- Do not make any modification to the product.
- Do not disassemble the product, unless required by installation or maintenance instructions.

6.2 Replacement parts

Refer to catalogue for replacement parts.

6.3 Addition and removal of manifold stations

Refer to catalogue for additional information.

7 Limitations of Use

7.1 Limited warranty and disclaimer/compliance requirements

Refer to Handling Precautions for SMC Products.

Warning

7.2 Return of the valve to the de-energised position

When electricity is cut, the valve returns to the de-energised position by spring force.

7.3 Holding of pressure

Since valves are subject to air leakage, they cannot be used for applications such as holding pressure (including vacuum) in a system.

7.4 Cannot be used as an emergency shut-off valve

This product is not designed for safety applications such as an emergency shut-off valve. If the valves are used in this type of system, other reliable safety assurance measures should be adopted.

Caution

7.5 Leakage voltage

Ensure that any leakage voltage caused by the leakage current when the switching element is OFF causes $\leq 2\%$ of rated voltage across the valve.

7.6 Low temperature operation

Unless otherwise indicated in the specifications for each valve, operation is possible to -10°C , but appropriate measures should be taken to avoid solidification or freezing of drainage and moisture, etc.

7.7 Vacuum release application

- Use 3 (R) port for vacuum pressure and 1 (P) port for vacuum release pressure.
- Set the pressure so that the pressure difference between the 3(R) and 1(P) ports does not exceed the maximum operating pressure of the valve.
- When the 3(R) port is used for the vacuum release (atmospheric pressure to positive pressure) and the 1(P) port is used for the vacuum, use the normally open (N.O.) specifications.

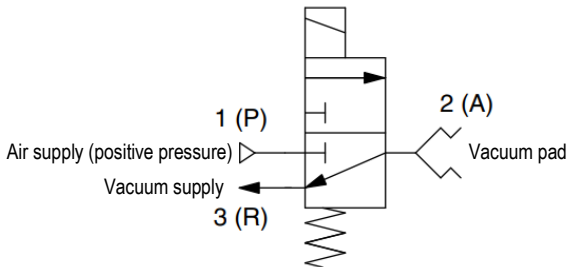

Figure 4.

8 Product Disposal

This product shall not be disposed of as municipal waste. Check your local regulations and guidelines to dispose this product correctly, in order to reduce the impact on human health and the environment.

9 Contacts

Refer to www.smcworld.com or www.smc.eu for your local distributor/importer.

SMC Corporation

URL : <https://www.smcworld.com> (Global) <https://www.smc.eu> (Europe)
 SMC Corporation, 4-14-1, Sotokanda, Chiyoda-ku, Tokyo 101-0021, Japan
 Specifications are subject to change without prior notice from the manufacturer.
 © 2022 SMC Corporation All Rights Reserved.
 Template DKP50047-F-085M