



ORIGINAL INSTRUCTIONS

**Instruction Manual
Vacuum Gripper
Series ZXP7*12**



The intended use of the vacuum gripper is to mount on a robot and grip / release a workpiece.

1 Safety Instructions

These safety instructions are intended to prevent hazardous situations and/or equipment damage. These instructions indicate the level of potential hazard with the labels of "Caution," "Warning" or "Danger." They are all important notes for safety and must be followed in addition to International Standards (ISO/IEC)¹⁾, and other safety regulations.

- ¹⁾ ISO 4414: Pneumatic fluid power — General rules and safety requirements for systems and their components.
- ISO 4413: Hydraulic fluid power — General rules and safety requirements for systems and their components
- IEC 60204-1: Safety of machinery - Electrical equipment of machines. (Part 1: General requirements)
- ISO 10218-1: Robots and robotic devices - Safety requirements for industrial robots - Part 1: Robots.
- Refer to product catalogue, Operation Manual and Handling Precautions for SMC Products for additional information.
- Keep this manual in a safe place for future reference.

Danger	Danger indicates a hazard with a high level of risk which, if not avoided, will result in death or serious injury.
Warning	Warning indicates a hazard with a medium level of risk which, if not avoided, could result in death or serious injury.
Caution	Caution indicates a hazard with a low level of risk which, if not avoided, could result in minor or moderate injury.

Warning

- Always ensure compliance with relevant safety laws and standards.
- All work must be carried out in a safe manner by a qualified person in compliance with applicable national regulations.

2 Specifications

2.1 Common Specifications

Mechanical interface	Compliant with ISO 9409-1-50-4-M6	
Fluid	Air	
Operating temperature range	5 to 50	
Connector type	M8 8 Pin (socket)	
Weight [g]	ZXP7N12-X1*	586
	ZXP7A12-X1*	810
	Example) ZXP7A12-ZPB25JS-X1	863 <small>Note 1</small>
Max workload [kg] ^{Note 2}	7	
Impact/vibration resistance [m/s ²] ^{Note 3}	150/30	
Air supply port (P)	One touch fitting (Ø6)	
Power supply voltage [V]	DC24 ± 10%	

- Note 1) The weight changes by the selected suction cup.
- Note 2) Limited by the cup diameter, mounting orientation or workpiece. The weight of the workpiece shall be maximum workload or less. Gripping or transfer of workload exceeding the maximum workload leads to the decrease of vacuum due to air leakage.
- Note 3) Impact resistance: The characteristics are satisfied after tested one time in each of the X, Y and Z directions without energization (Initial value).

2 Specifications - continued

Vibration resistance: The characteristics are satisfied after tested a one sweep in each of the X, Y and Z directions at 10 to 500 Hz without energization (Initial value).

2.2 Vacuum Ejector Specifications

Max. vacuum pressure [kPa] ^{Note 4}	-84
Max. suction flow [L/min (ANR)] ^{Note 4}	17
Air consumption [L/min (ANR)] ^{Note 4}	57
Supply pressure range [MPa]	0.3 to 0.55
Standard supply pressure [MPa] ^{Note 5}	0.5

- Note 4) Values at the standard supply pressure. Values are based on standard of SMC measurements. They depend on atmospheric pressure (weather, altitude, etc.) and measurement method.
- Note 5) This shows the pressure just before the supply (P) port. The performance such as vacuum pressure may reduce, depending on supply air capacity, the piping volume (piping length and diameter) and affection of air consumption of other devices which operate at the same time

2.3 Pressure Switch Specifications

Model	ZSE20-*-*-M5-A1
Rated pressure range [kPa]	0 to -101
Display accuracy [%]	±2 F.S. ±1 digit (Ambient temperature at 25°C ±3°C)
Repeatability [%]	±0.2 F.S. ±1 digit
Temperature characteristics [%]	±2 F.S. (25°C standard)

2.4 Valve Specifications

Model	V114
-------	------

3 Installation

- Do not install the product unless the safety instructions have been read and understood.

3.1 Parts included in the package

- Robot mounting flange: 1pc.
- Vacuum gripper: 1pc.
- Suction cup with adapter: 4pcs
- Plug: 4pcs (when "cup mounting flange shape" is selected). Used for decreasing the number of suction cups).
- Hexagon socket head cap screw (M6x10): 8 pcs.
- Parallel pin (6x10): 1 pc.

3 Installation - continued

- Reducer elbow: KQ2L06-08A 1 pc. This part is used for the Ø8-piping of the robot for HC20SDTP and H20DTP.
- Male elbow: KQ2L06-M5A1 1 pc. This part is used to the M5 screw hole of HC10DTP robot tool flange.

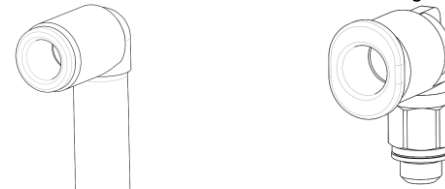

- Polyurethane tube: 2m. Part no. TU0604BU.



3.2 Mounting

Warning

- Mounting procedure**
- Confirm the gasket seal on the adapter, then mount 4 cups with adapter to the vacuum gripper (Tightening torque: 1Nm or tighten for 45 degrees using a spanner after tightening by hand).
 - Mount parallel pin to the robot tool flange pin hole.
 - Align the parallel pin of the robot tool flange with the robot mounting flange and assemble them with bolts included in the accessories (Tightening torque: 5.2+/-0.5 Nm).
 - Tighten the vacuum gripper to the robot mounting flange (Tightening torque: 5.2+/-0.5 Nm).

Removal procedure

Removal should be performed by following the mounting procedure in reverse.

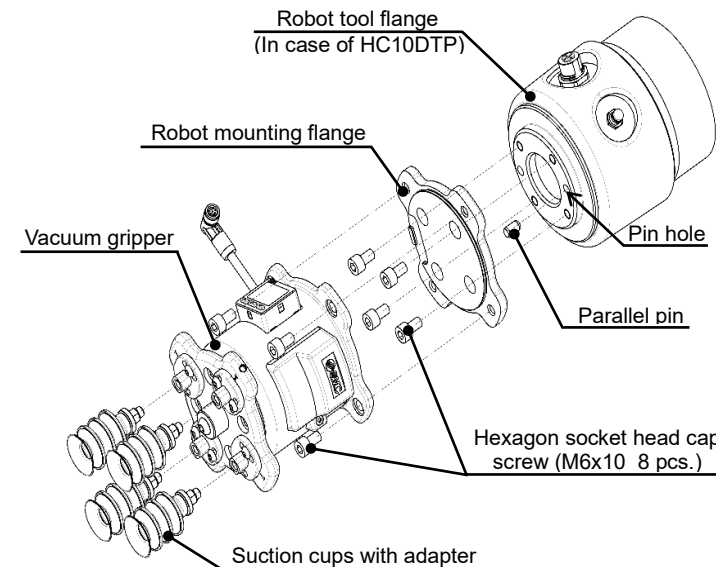
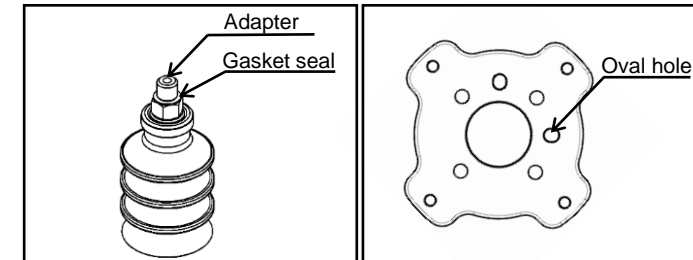

3 Installation - continued

3.3 Wiring

- Mount the connector cable
- After mounting the robot mounting flange (section 3.2), connect the robot side of the connector to the vacuum gripper size connector until you hear a click. After connecting these, lightly pull the connector on both sides to check it is secure.

Caution

Install the vacuum gripper in the direction of the lower figure where the slack of the M8 connector cable is small. If the cable is loose, it may be caught by peripheral equipment, workpiece, human body, etc. while the robot is running, causing unexpected accidents.

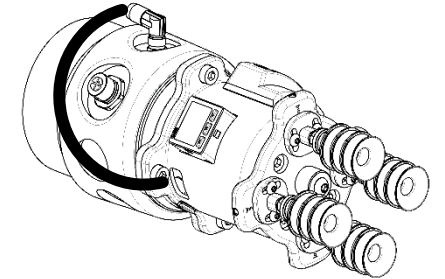

- M8 connector pin

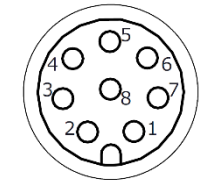

M8 connector pin layout

Pin no.	Wire color	Function
1	-	N.C.(Non connection)
2	-	N.C.(Non connection)
3	Green	Pressure switch output
4	-	N.C.(Non connection)
5	Gray	Power supply voltage (24V)
6	Pink	Release valve*
7	Blue	Pilot valve for supply*
8	Red	Power supply voltage (GND)

*Set the polarity of the robot output to the selected switch polarity (NPN/PNP)

3.4 Piping

Caution

- Before connecting piping make sure to clean up chips, cutting oil, dust etc.
- When installing piping or fittings, ensure sealant material does not enter inside the port. When using seal tape, leave 1 thread exposed on the end of the pipe/fitting.
- Tubing: Connect a tube applicable tube O.D. Ø6 to the air pressure supply (P) port. To remove the tube, push the release button and pull out the tube.

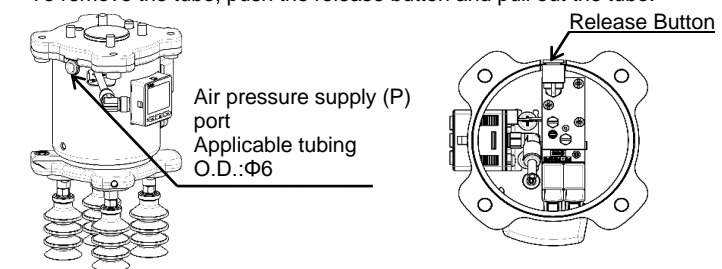

3 Installation - continued

3.5 Circuit diagram

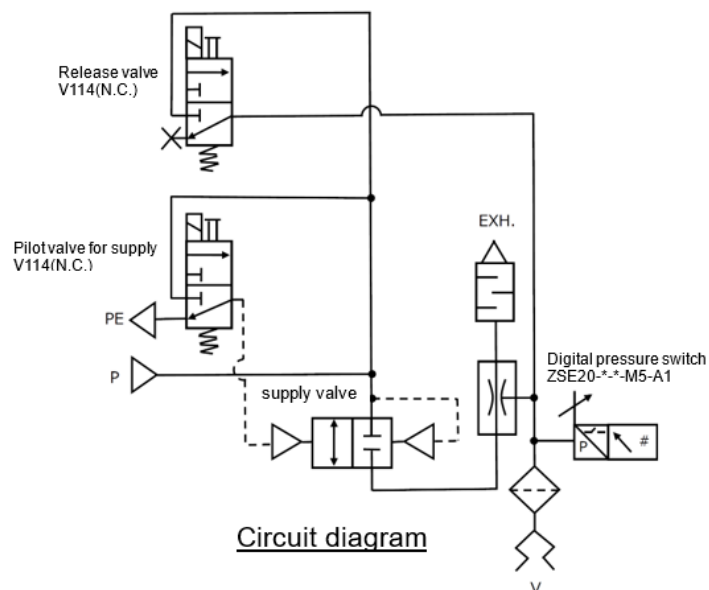

3.6 Environment

Warning

- Do not use in an environment where corrosive gases, chemicals, salt water or steam are present.
- Do not use in an explosive atmosphere.
- Do not expose to direct sunlight. Use a suitable protective cover.
- Do not install in a location subject to vibration or impact in excess of the product's specifications.
- Do not mount in a location exposed to radiant heat that would result in temperatures in excess of the product's specifications.

4 How to Order

Refer to catalogue for 'How to Order'.

5 Outline Dimensions

Refer to catalogue for outline dimensions.

6 Maintenance

Implement the maintenance and check shown below in order to use the vacuum gripper safely and in an appropriate way for a long period of time.

6.1 Maintenance for vacuum gripper

Caution

Check before and after the maintenance work

When the product is to be removed, turn off the power supply and be sure to cut the supply pressure and exhaust the compressed air. Confirm the air is released to atmosphere.

When mounting the product after the maintenance work, supply compressed air, connect the power, check it functions properly and have a leakage inspection

Maintenance should be performed according to the procedure in the operation manual

Improper handling can cause damage and malfunction of equipment and machinery

Maintenance work

Compressed air can be dangerous when handled incorrectly. Therefore, in addition to observing the product specifications, replacement of silencer and other maintenance activities should be performed by

personnel with sufficient knowledge and experience pertaining to pneumatic equipment.

Draining

Remove condensate from air filters and mist separators regularly. If the collected drainage is drained to the downstream side, it can stick inside of the product, causing operation failure and failure to reach the specified vacuum pressure

Replace the silencer built into the vacuum gripper regularly

It is recommended to replace the silencer when the pressure drop reaches 5kPa as a guideline. The replacement cycle varies depending on the operating conditions, operating environment, and supply air quality.

6 Maintenance - continued

However, if there is a vacuum pressure drop and/or delay in the vacuum (gripping) response time which causes problem with the settings during operation, stop the operation of the product and replace the silencer regardless of the above mentioned replacement guideline.

Part number for the silencer assembly for replacement: ZX1-HS1

Silencer Assembly Replacement Procedure

- Remove the cover.
- Loosen the 2 cross-recessed pan head screws to remove the silencer assembly.
- Assemble the new silencer assembly.
- Mount the cover.

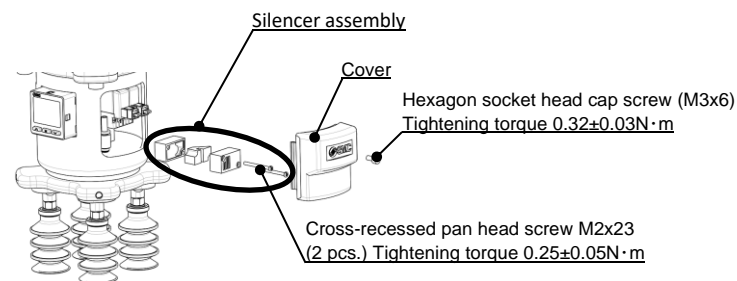

- Do not disassemble or modify the product, other than the replacement parts specified in this manual.

6.2 Maintenance for suction cup

Caution

Suction cups are disposable. Replace them on a regular basis.

Continued use of suction cups will cause wear and tear on the gripping surface, and the exterior dimensions will gradually get smaller and smaller. As the cups' diameter gets smaller, their lifting force will decrease, though gripping will still remain possible. It is extremely difficult to provide advice on the frequency of suction cup replacement. This is because there are numerous factors at work, including surface roughness, operating environment (temperature, humidity, ozone,

solvents, etc.), and operating conditions (vacuum pressure, workpiece weight, pressing force of the suction cups on the workpieces, presence or absence of a buffer, etc.). (The weakening of bent parts or the wear or sticking of rubber parts may occur with the bellows type cup.) Thus, the customer should decide when suction cups should be replaced, based on their condition at the time of initial use. The adapter screw point may become loose depending on the operating conditions and environment. Be sure to perform regular maintenance.

Replacement of suction cups

- Pull the lock ring upward, and, after lifting it up to the adapter, remove the old cup by pulling it downward.
- While holding the lock ring in the raised position place a new cup onto the adapter.
- Confirm that the cup is securely in place, and then return the lock ring to its original position.

Note) The cup without lock ring is just inserted to the end of the adapter.

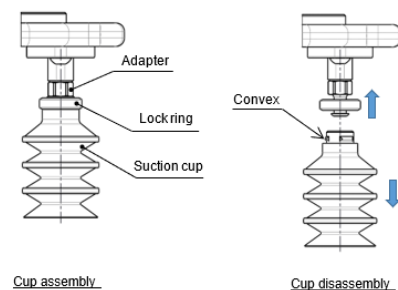

7 Limitations of Use

7.1 Limited warranty and disclaimer/compliance requirements

Refer to Handling Precautions for SMC Products.

Caution

Exhaust Noise

When vacuum ejector generates vacuum, noise can be heard from the exhaust port when the standard supply pressure is close to the pressure that generates peak vacuum pressure making vacuum pressure unstable. If the vacuum pressure range is adequate for gripping, there should not be a problem. If the noise causes a problem or affects the setting of the pressure switch, change the supply pressure slightly to avoid the pressure range of the noise.

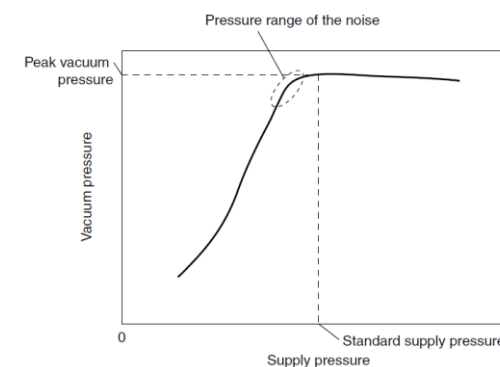

8 Product Disposal

This product shall not be disposed of as municipal waste. Check your local regulations and guidelines to dispose this product correctly, in order to reduce the impact on human health and the environment.

9 Contacts

Refer to www.smcworld.com or www.smc.eu for your local distributor/importer.

SMC Corporation

URL : <https://www.smcworld.com> (Global) <https://www.smc.eu> (Europe)
SMC Corporation, 4-14-1, Sotokanda, Chiyoda-ku, Tokyo 101-0021, Japan
Specifications are subject to change without prior notice from the manufacturer.
© SMC Corporation All Rights Reserved.
Template DKP50047-F-085N