

# CU Series

ø10, ø16, ø20, ø25, ø32

## Construction

### With auto switch

ø10

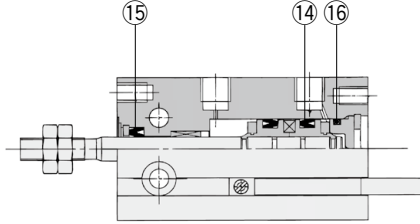
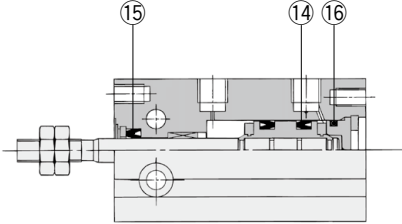

ø16 to ø32

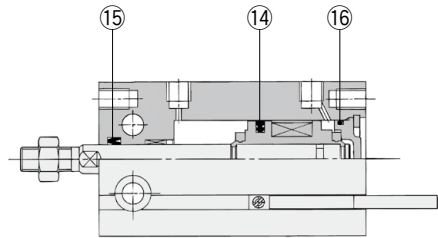
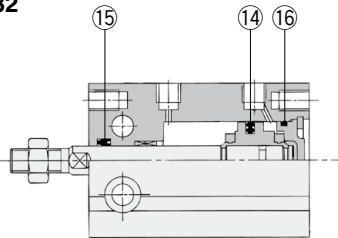

\* The numbers correspond with those in the "Construction" of the CU series in the **Web Catalog**.

### Seal Kit List

No.	Description	Material	Note
14	Piston seal	NBR	
15	Rod seal		
16	Gasket		

### Replacement Parts: Seal Kit

Bore size (mm)	Part no.	Contents
10	CU10D-PS	Set of nos. 14, 15, 16
16	CU16D-PS	
20	CU20D-PS	
25	CU25D-PS	
32	CU32D-PS	

\* ø6 cannot be repaired.

\* The seal kit includes 14, 15, 16. Order the seal kit based on each bore size.

\* The seal kit includes a grease pack (10 g).

Order with the following part number when only the grease pack is required.

**Grease pack part no.: GR-S-010 (10 g)**

Actuators

Rotary Actuators  
Air Grippers

Modular F.R.L.  
Pressure Control Equipment

Air Preparation  
Equipment

Industrial Filters

Replacement  
Procedure

Actuators

Rotary Actuators  
Air Grippers

Modular F.R.L.  
Pressure Control Equipment

Air Preparation Equipment  
Industrial Filters

# CU Series ø10, ø16, ø20, ø25, ø32

## Construction

### Single acting, spring return

ø10

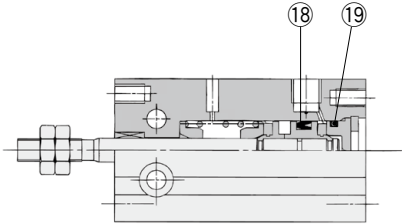

ø16 to ø32

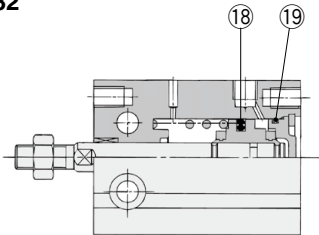

### With auto switch

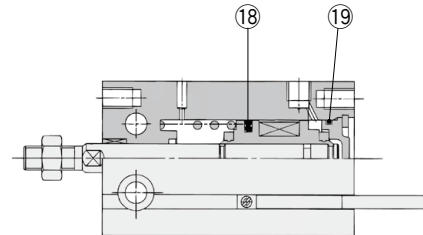
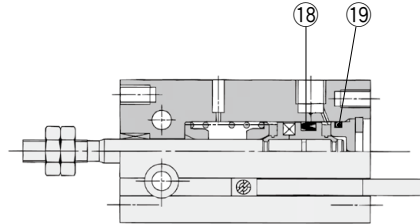

\* The numbers correspond with those in the "Construction" of the CU series in the **Web Catalog**.

### Seal Kit List

No.	Description	Material	Note
18	Piston seal	NBR	
19	Gasket		

### Replacement Parts: Seal Kit

Bore size (mm)	Part no.	Contents
10	CU10S-PS	Set of nos. 18, 19
16	CU16S-PS	
20	CU20S-PS	
25	CU25S-PS	
32	CU32S-PS	

\* ø6 cannot be repaired.

\* The seal kit includes 18, 19. Order the seal kit based on each bore size.

\* The seal kit includes a grease pack (10 g).

Order with the following part number when only the grease pack is required.

**Grease pack part no.: GR-S-010 (10 g)**

Actuators

Rotary Actuators  
Air Grippers

Modular F.R.L.  
Pressure Control Equipment

Air Preparation  
Equipment

Industrial Filters

Replacement  
Procedure

Actuators

Rotary Actuators  
Air Grippers

Modular F.R.L.  
Pressure Control Equipment

Air Preparation Equipment  
Industrial Filters

# CU Series

ø10, ø16, ø20, ø25, ø32

## Construction

### Single acting, spring extend

ø10

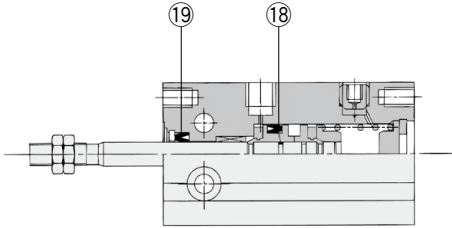

### With auto switch

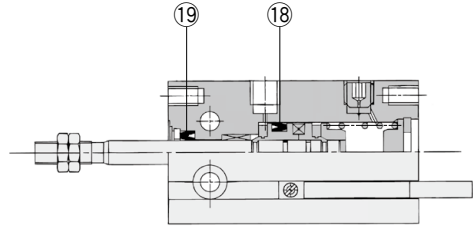

ø16 to ø32

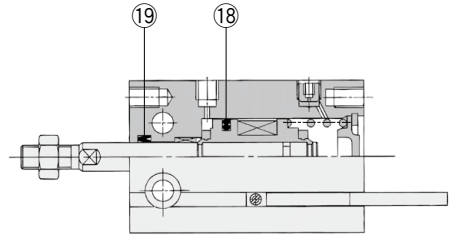
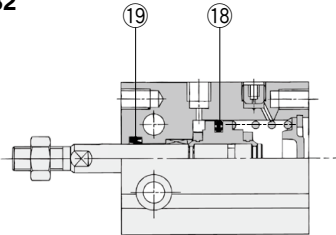

\* The numbers correspond with those in the "Construction" of the CU series in the **Web Catalog**.

### Seal Kit List

No.	Description	Material	Note
18	Piston seal	NBR	
19	Rod seal		

### Replacement Parts: Seal Kit

Bore size (mm)	Part no.	Contents
10	CU10T-PS	Set of nos. 18, 19
16	CU16T-PS	
20	CU20T-PS	
25	CU25T-PS	
32	CU32T-PS	

\* ø6 cannot be repaired.

\* The seal kit includes 18, 19. Order the seal kit based on each bore size.

\* The seal kit includes a grease pack (10 g).

Order with the following part number when only the grease pack is required.

**Grease pack part no.: GR-S-010 (10 g)**

# CU Series

ø10, ø16, ø20, ø25, ø32

## Construction

### With auto switch

ø10

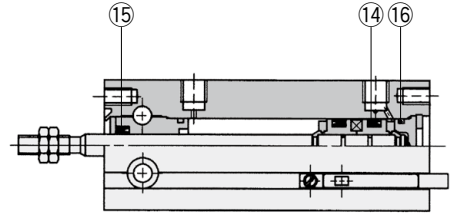
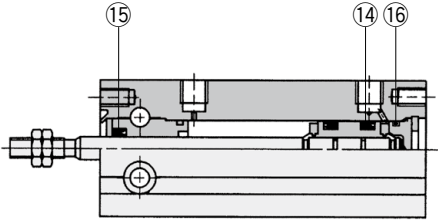

ø16 to ø32

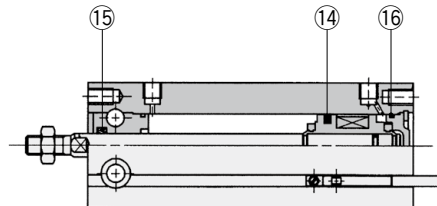
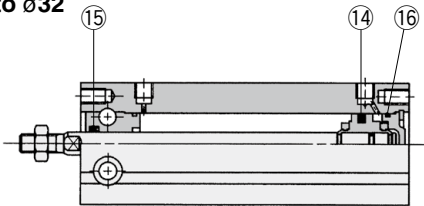

\* The numbers correspond with those in the "Construction" of the CU series in the **Web Catalog**.

### Seal Kit List

No.	Description	Material	Note
14	Piston seal	NBR	
15	Rod seal		
16	Gasket		

### Replacement Parts: Seal Kit

Bore size (mm)	Part no.	Contents
10	CU10D-PS	Set of nos. 14, 15, 16
16	CU16D-PS	
20	CU20D-PS	
25	CU25D-PS	
32	CU32D-PS	

\* ø6 cannot be repaired.

\* The seal kit includes 14, 15, and 16. Order the seal kit based on each bore size.

\* The seal kit includes a grease pack (10 g).

Order with the following part number when only the grease pack is required.

**Grease pack part no.: GR-S-010 (10 g)**

Actuators

Rotary Actuators  
Air Grippers

Modular F.R.L.  
Pressure Control Equipment

Air Preparation  
Equipment

Industrial  
Filters

Replacement  
Procedure

Actuators

Rotary Actuators  
Air Grippers

Modular F.R.L.  
Pressure Control Equipment

Air Preparation Equipment  
Industrial Filters

# CUX Series ø16, ø20, ø25, ø32

## Construction

With auto switch

ø16 to ø32

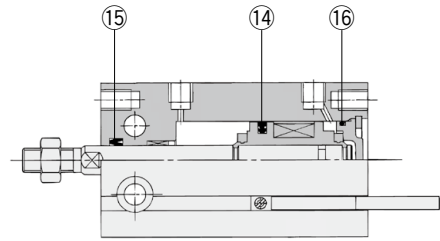
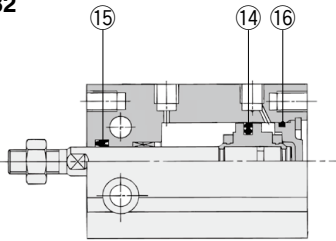

- \* The construction of the low speed cylinder CUX series is the same as the CU series.
- \* The numbers correspond with those in the "Construction" of the CU series in the **Web Catalog**.

### Seal Kit List

No.	Description	Material	Note
14	Piston seal	NBR	
15	Rod seal		
16	Gasket		

### Replacement Parts: Seal Kit

Bore size (mm)	Part no.	Contents
16	CUX16-PS	Set of nos. 14, 15, 16
20	CUX20-PS	
25	CUX25-PS	
32	CUX32-PS	

- \* ø10 cannot be repaired.
- \* The seal kit includes 14, 15, and 16. Order the seal kit based on each bore size.
- \* Since the seal kit does not include a grease pack, it should be ordered separately.

**Grease pack part no.:** GR-L-005 (5 g)  
 GR-L-010 (10 g)  
 GR-L-150 (150 g)

Actuators

Rotary Actuators  
Air Grippers

Modular F.R.L.  
Pressure Control Equipment

Air Preparation  
Equipment

Industrial Filters

Replacement  
Procedure

Actuators

Rotary Actuators  
Air Grippers

Modular F.R.L.  
Pressure Control Equipment

Air Preparation Equipment  
Industrial Filters

# CU Series ø20, ø25, ø32

## Construction

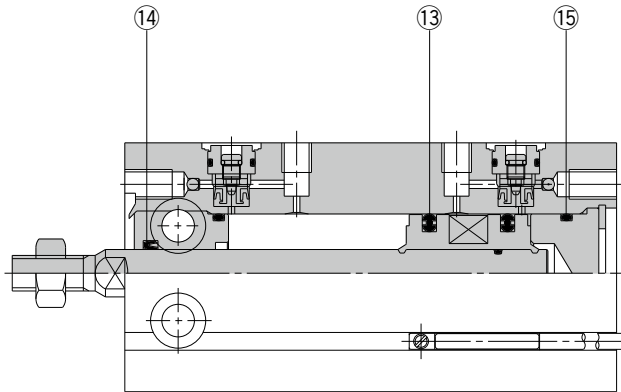

\* The numbers correspond with those in the "Construction" of the CU series in the **Web Catalog**.

### Seal Kit List

No.	Description	Material	Qty.	Note
13	Piston seal	NBR	2	
14	Rod seal		1	
15	Gasket		1	

### Replacement Parts: Seal Kit

Bore size (mm)	Part no.	Contents
ø20	CU20A-PS	Set of nos. 13, 14, 15
ø25	CU25A-PS	
ø32	CU32A-PS	

\* The seal kit includes 13, 14, 15. Order the seal kit based on each bore size.

\* The seal kit includes a grease pack (10 g).

Order with the following part number when only the grease pack is required.

**Grease pack part no.: GR-S-010** (10 g)